

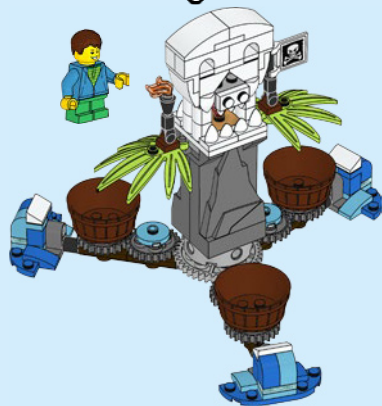

40346

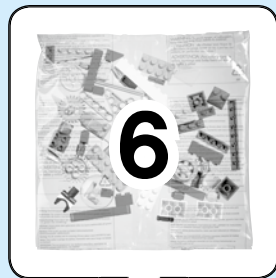

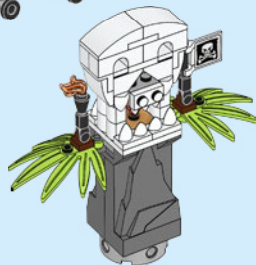
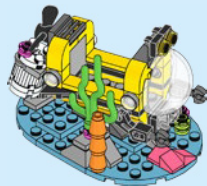
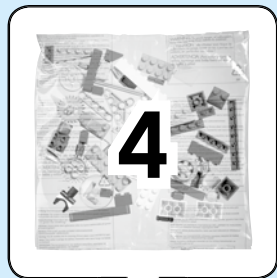

4

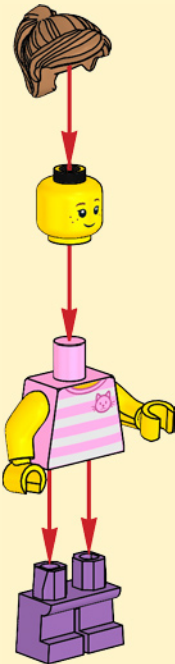
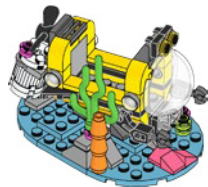
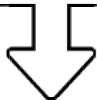
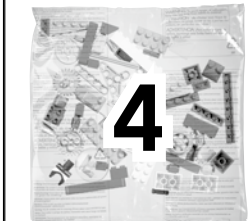

1

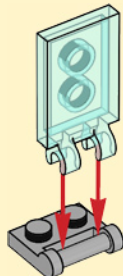

2



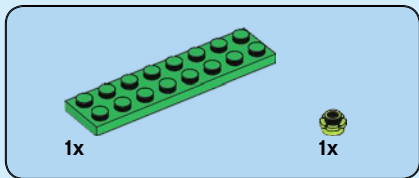

1

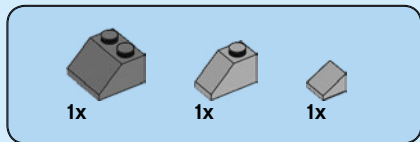
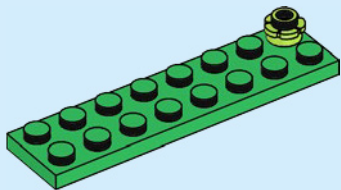

2

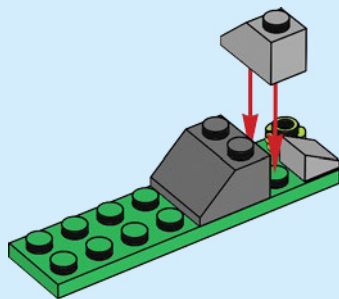

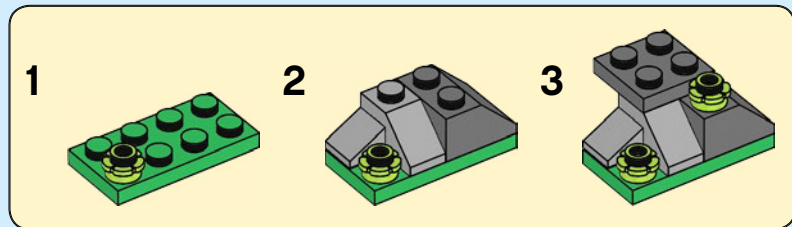
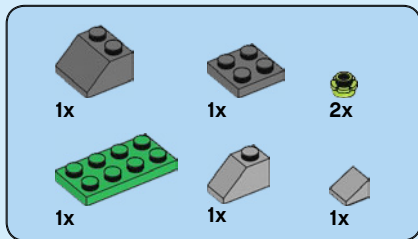

**3**

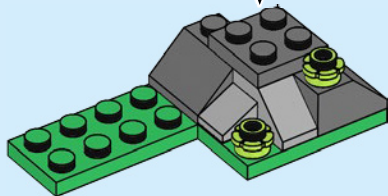

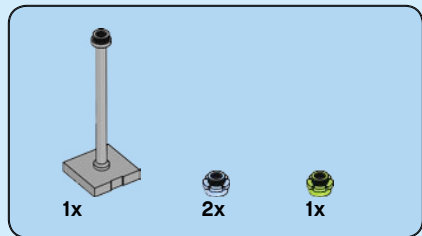

4

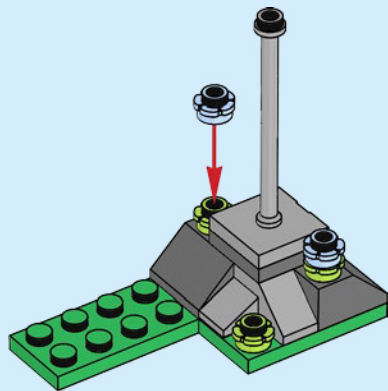

6



5

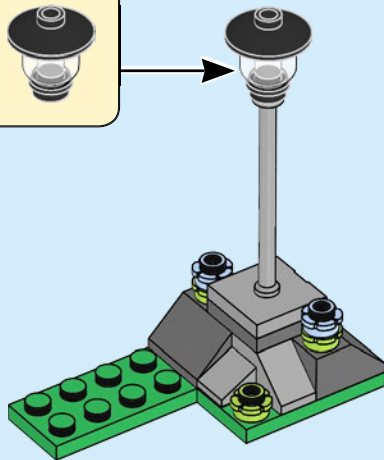
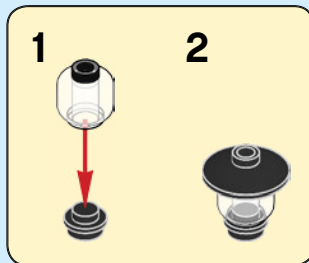

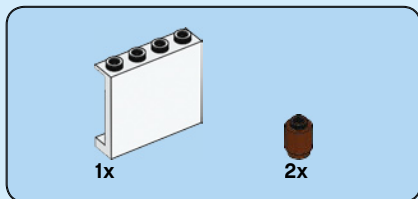

6

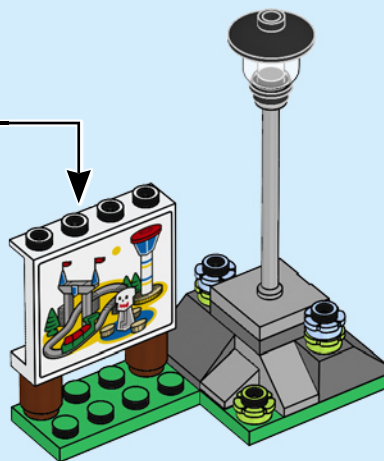
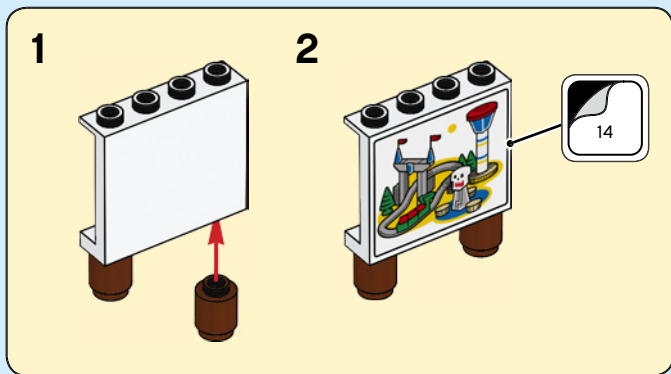



6x



6x

7

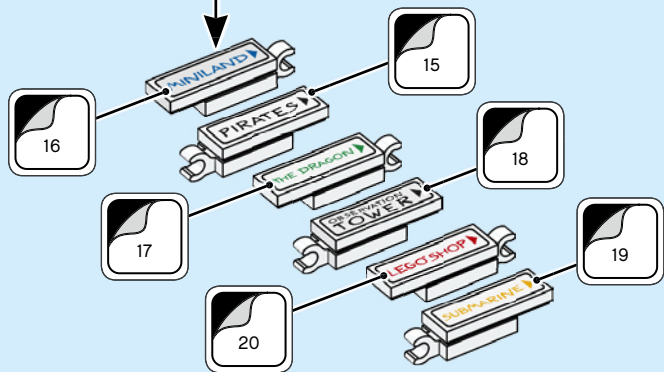
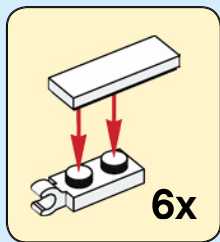

8

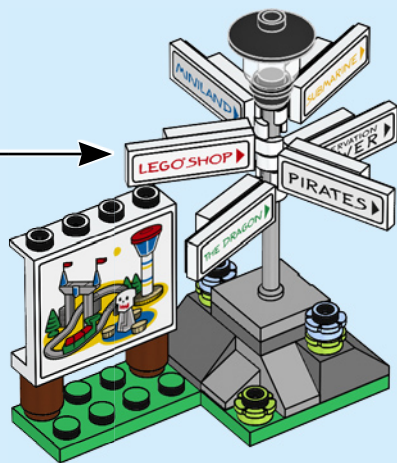



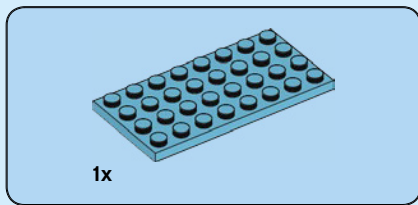
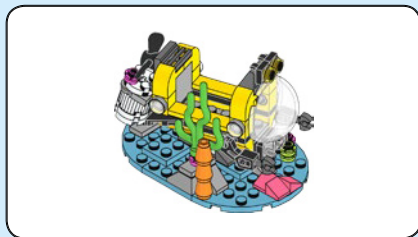

**1**

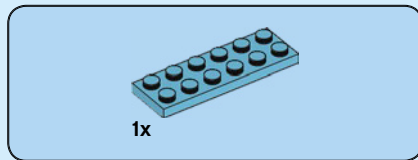
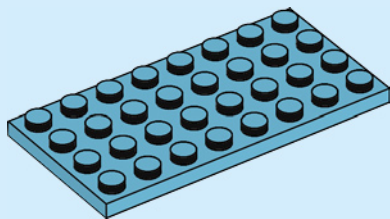

**2**

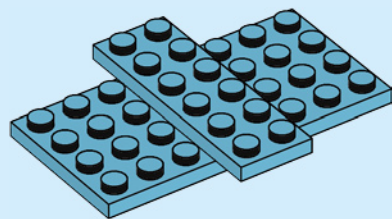

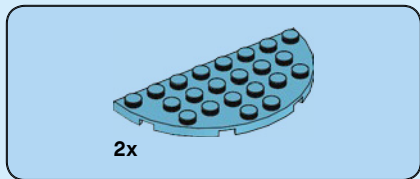

3

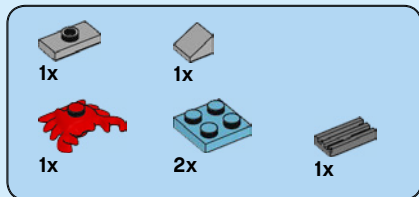
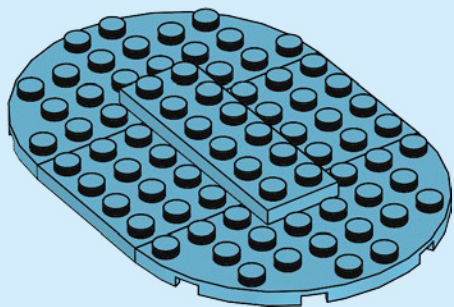

4

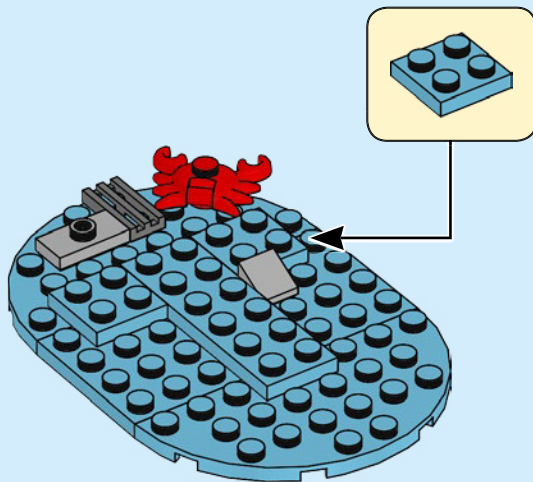

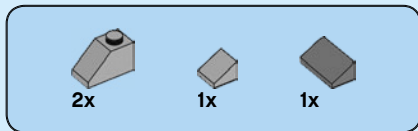

5

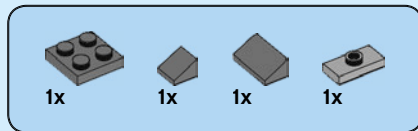
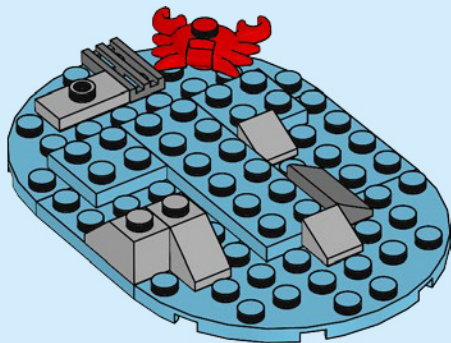

6

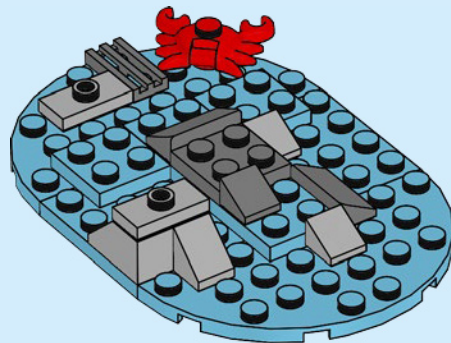



2x



2x



3x

7

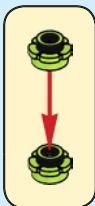
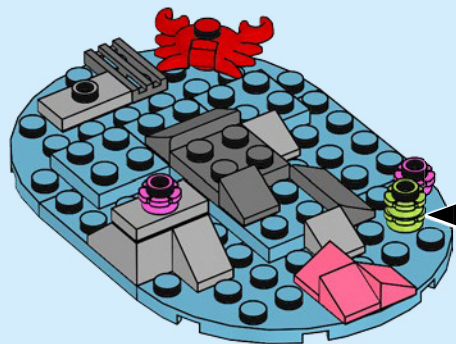

1x



1x

8

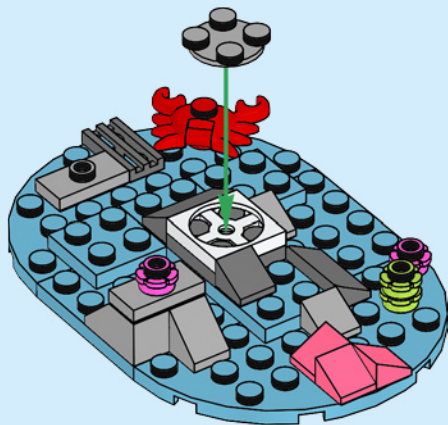

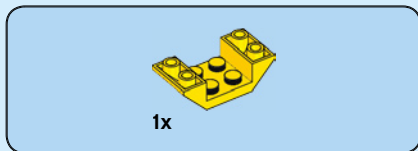

9

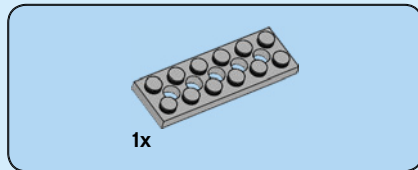
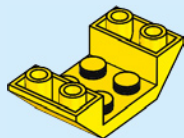

10

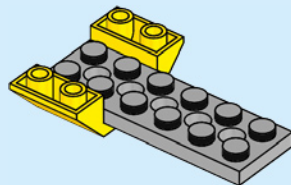

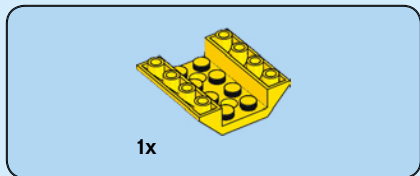

11

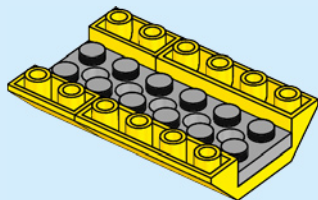

14

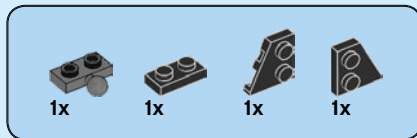

12

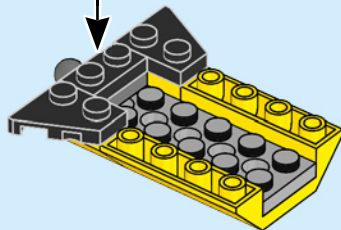
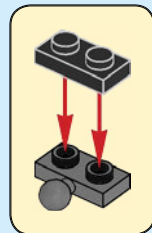



2x



2x

# 13

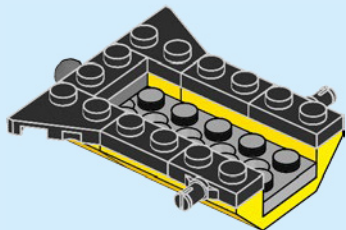

2x

# 14

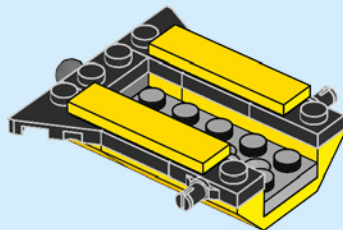



4x



4x



4x

15

1

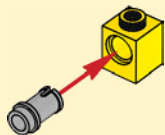

2



4x

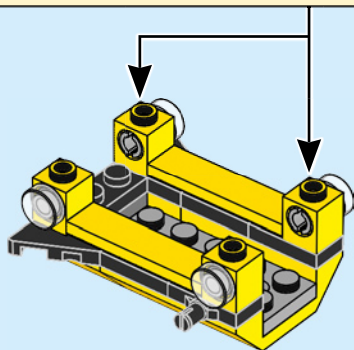

1x

16

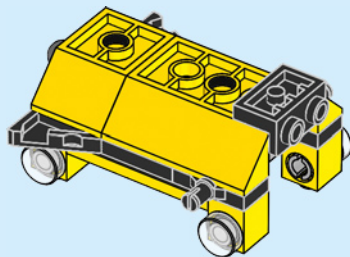





1x



1x

17

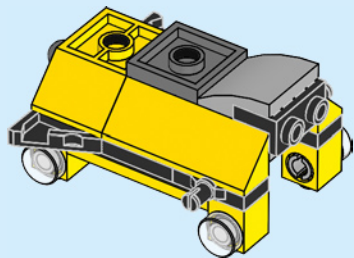

2x

18

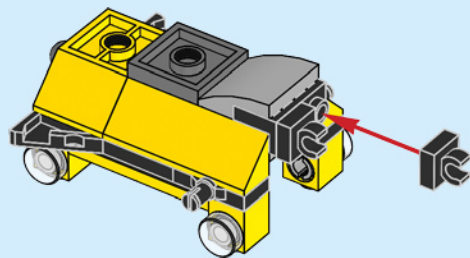

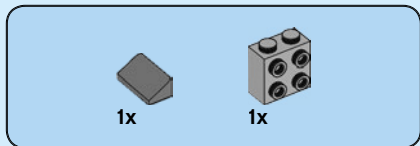

19

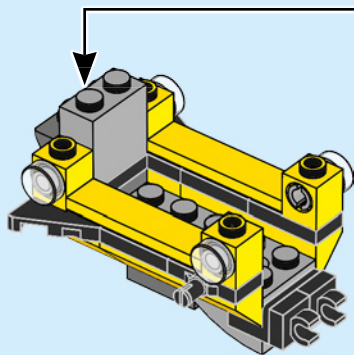
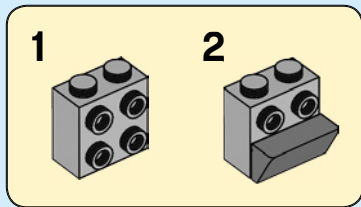

20

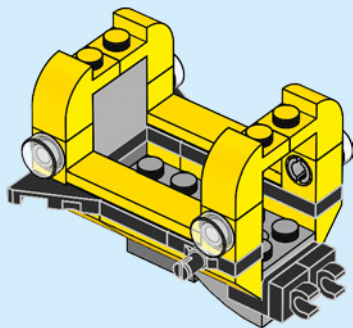



1x



1x

# 21

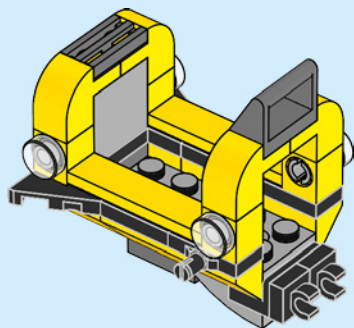

2x



2x

# 22

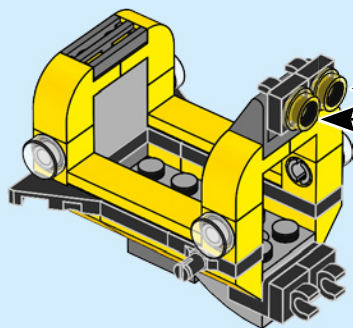

2x



2x



2x

# 23

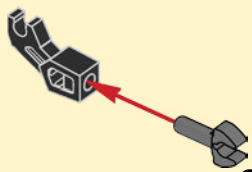

2x

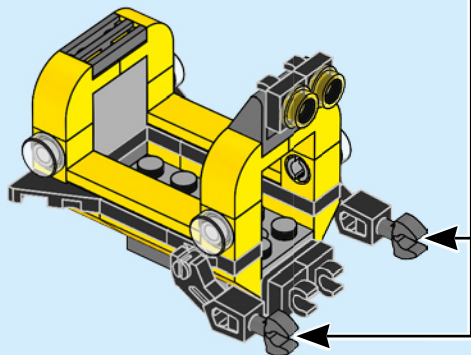

20



1x

# 24

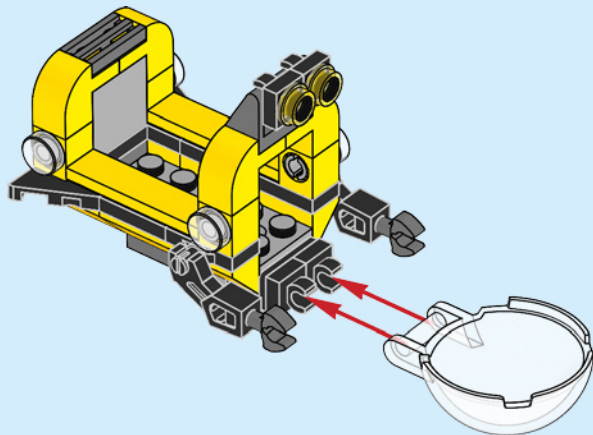



1x



1x

# 25

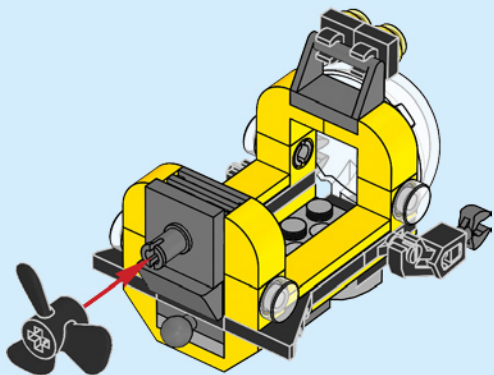

# 26

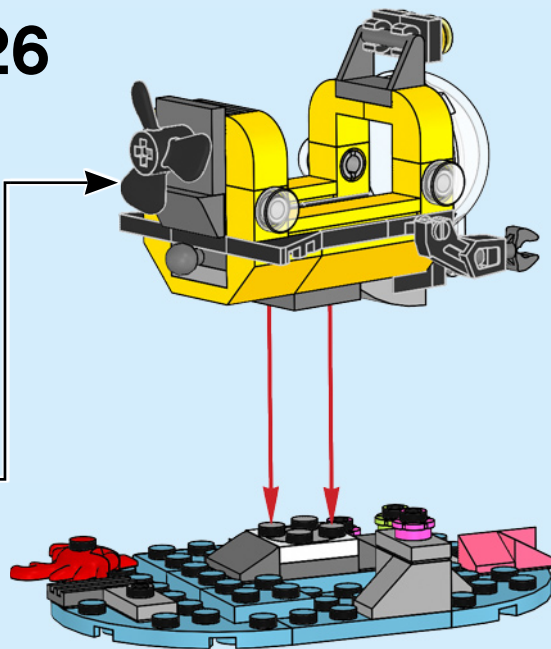

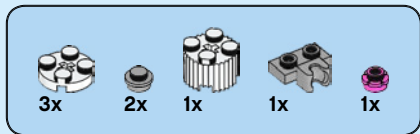

27

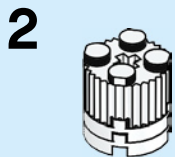
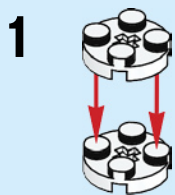

3

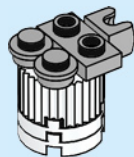

4

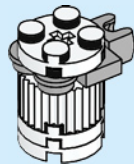

5

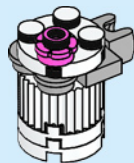

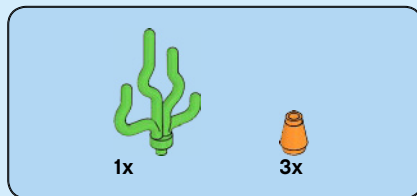
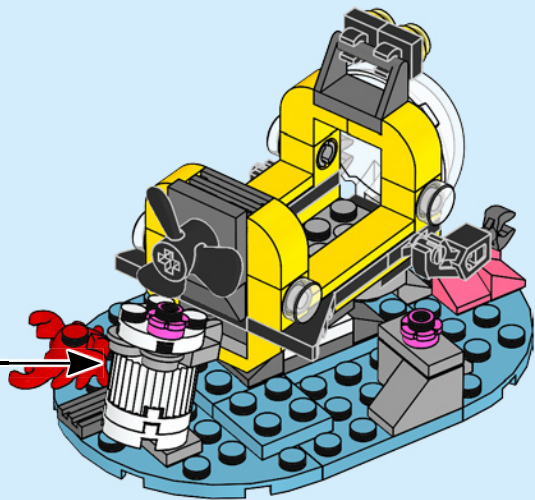

28

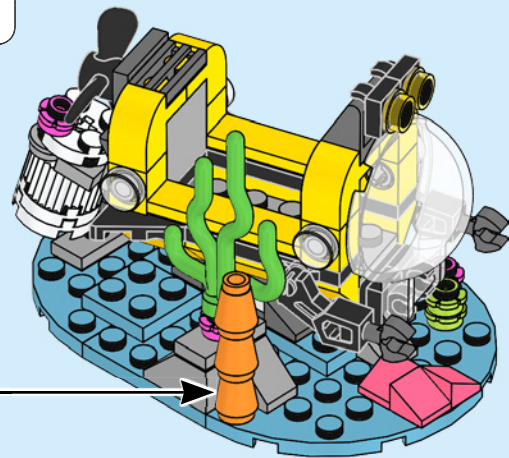
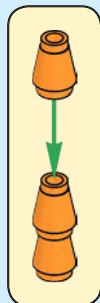

5

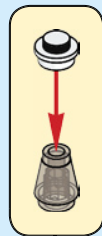
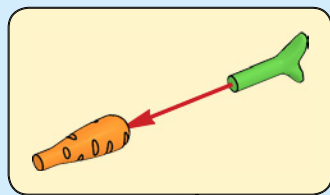
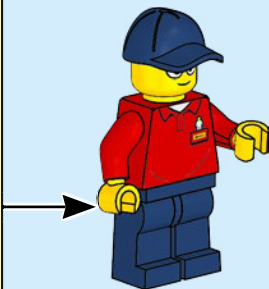
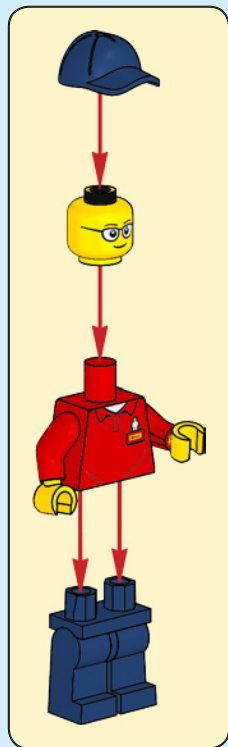



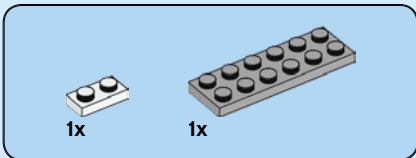

1

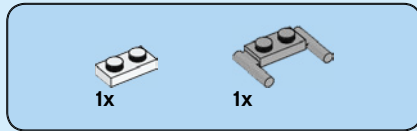
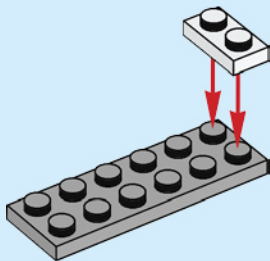

2

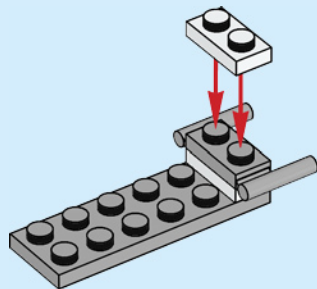



3

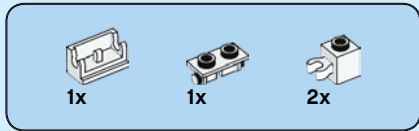
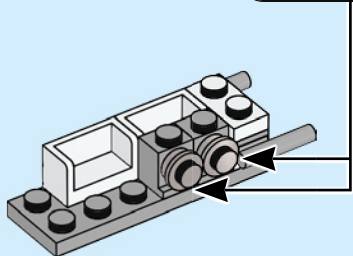
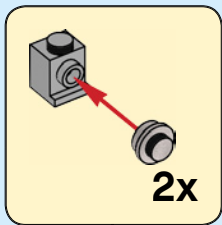

4

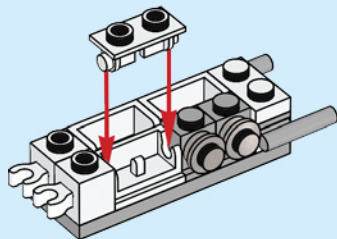

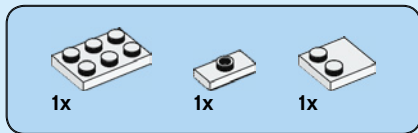

5

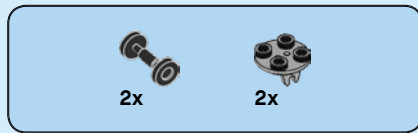
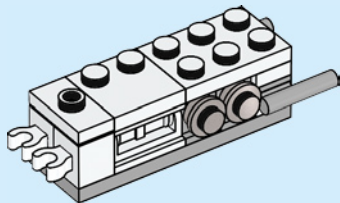

6

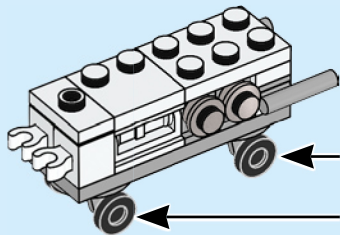
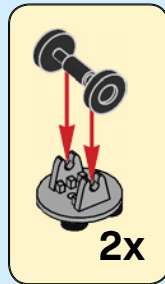

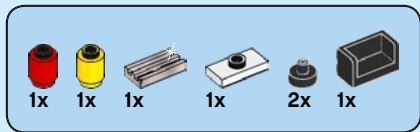

7

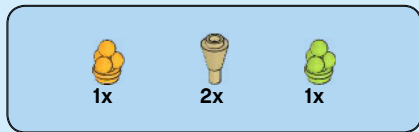
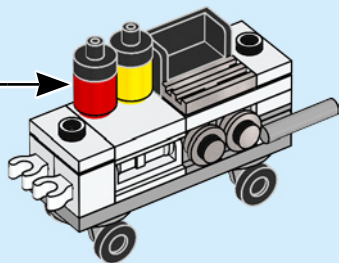
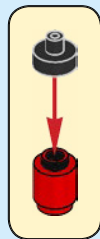

8

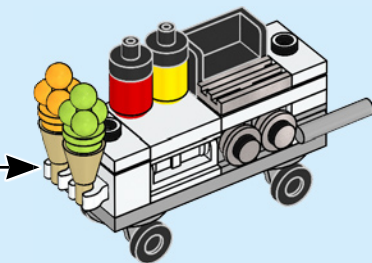
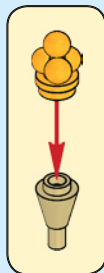

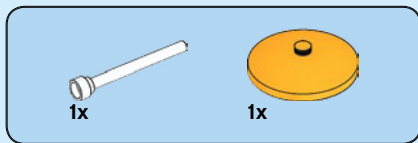

9

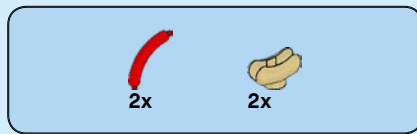
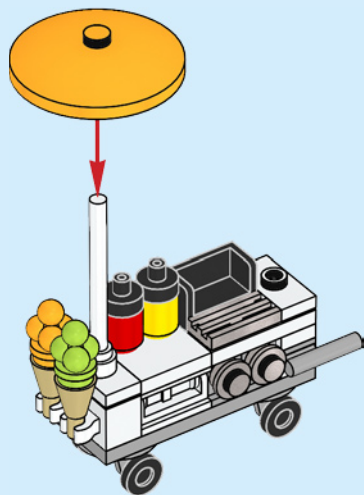

10

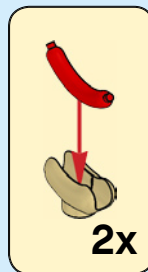
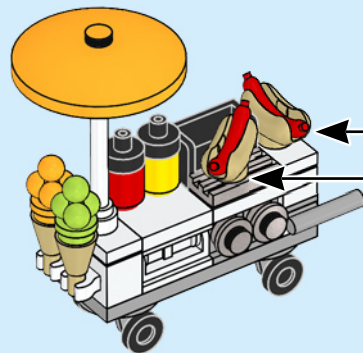

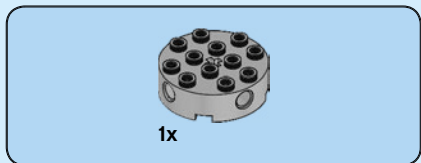
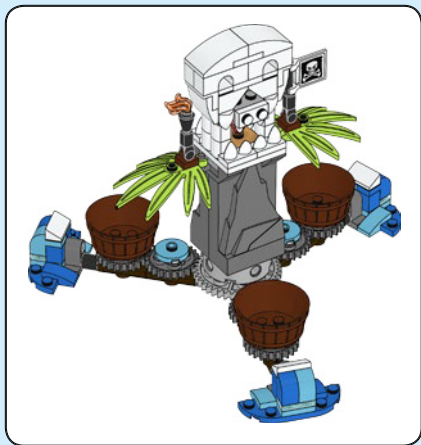

1x

1

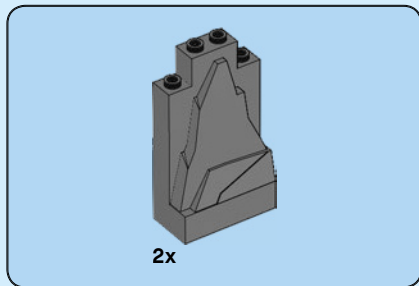

2x

2

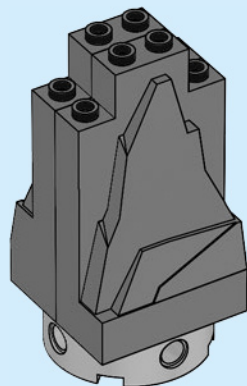

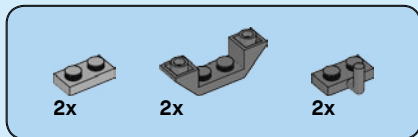

**3**

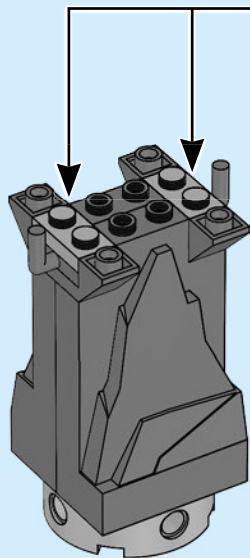
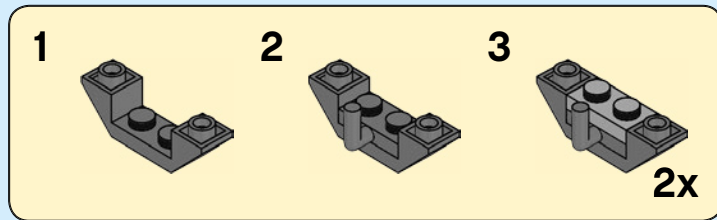

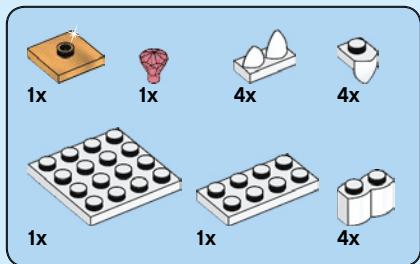

4

1

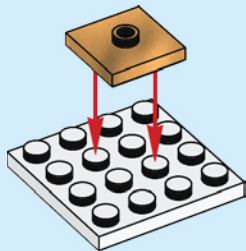

2

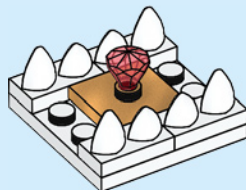

3

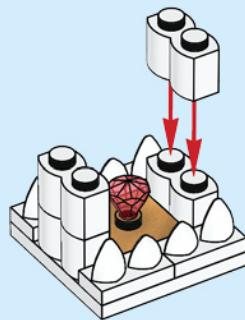



4

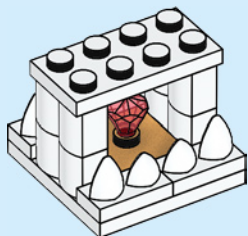

5

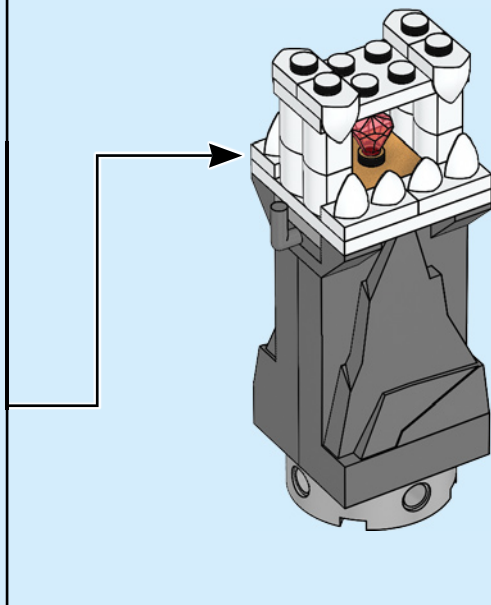
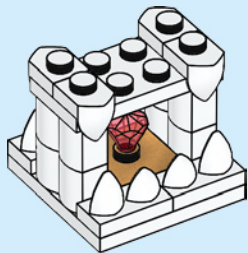



2x



2x

5

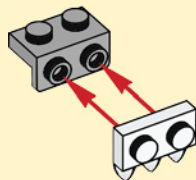
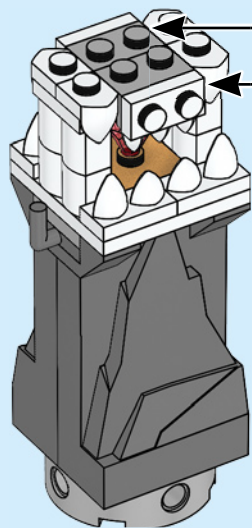

2x



2x



2x

6

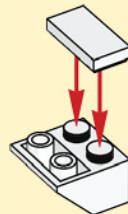
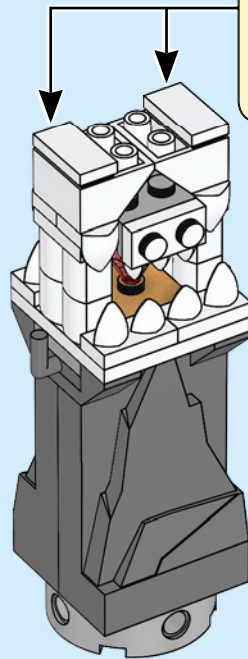

2x

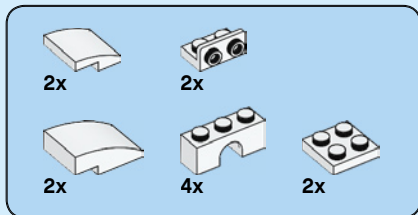
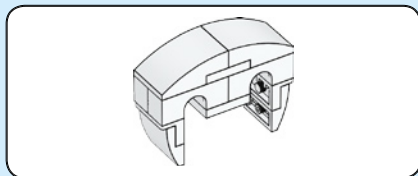

**7**

**1**

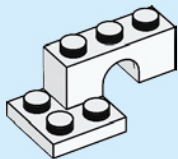

**2**

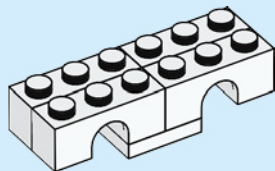

**3**

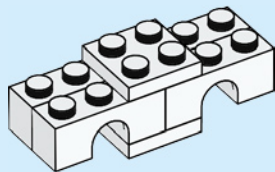

**4**

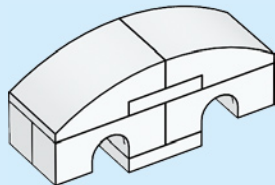

5

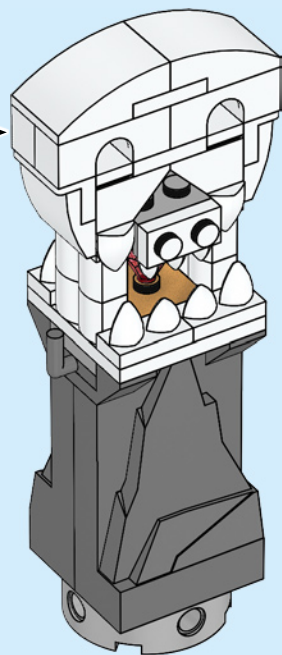
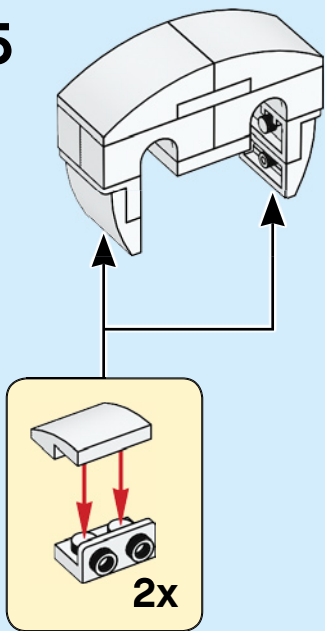

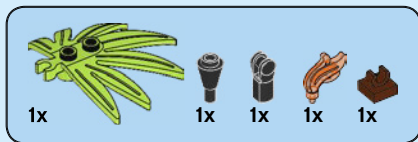

# 8

1

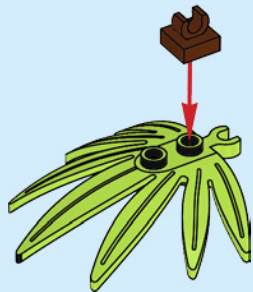

2

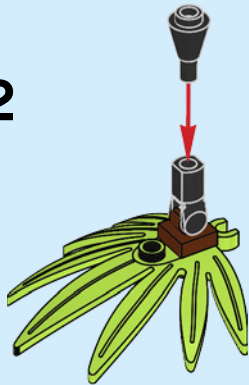

3

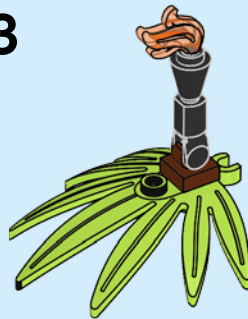

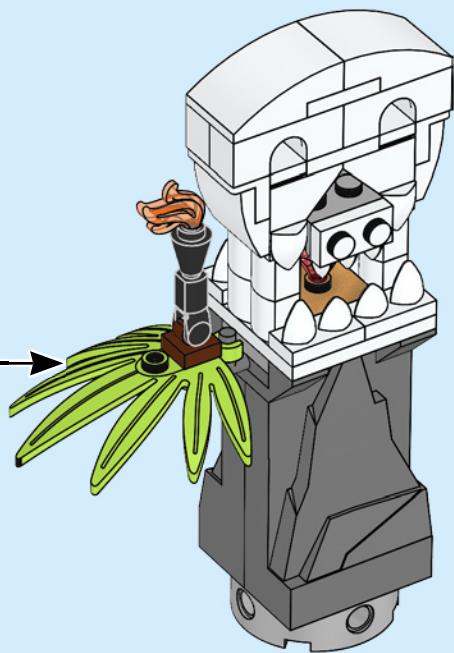

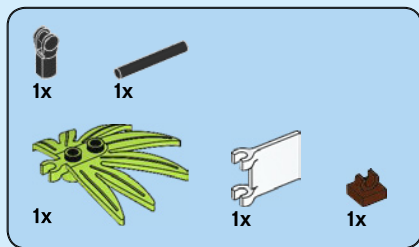

9

1

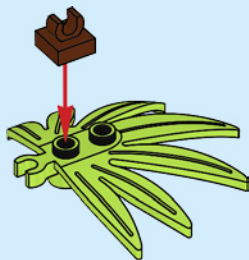

2

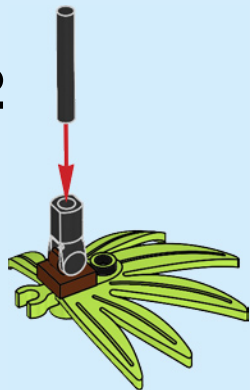

3

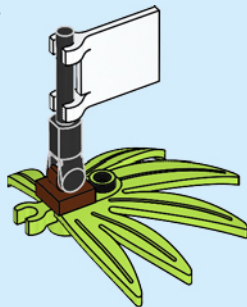

4



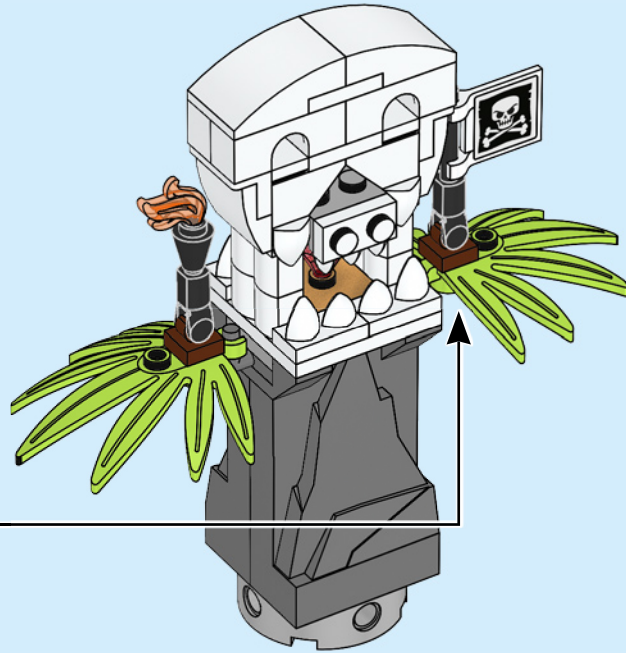



6

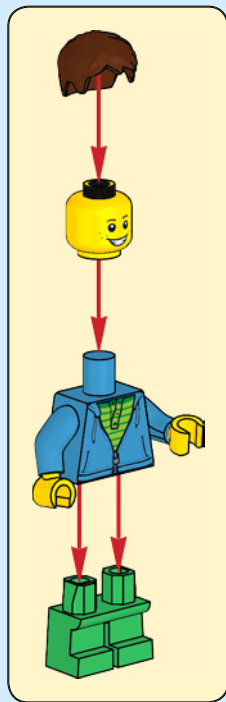
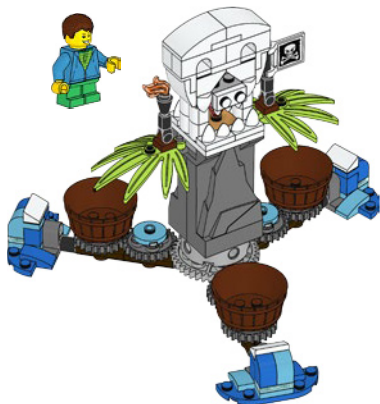
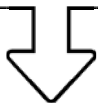

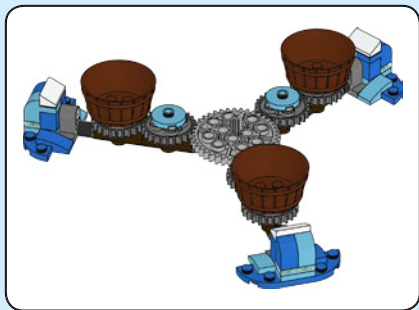

10

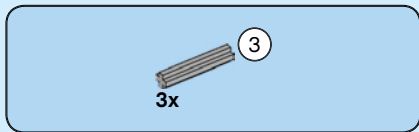

11

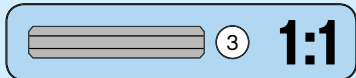
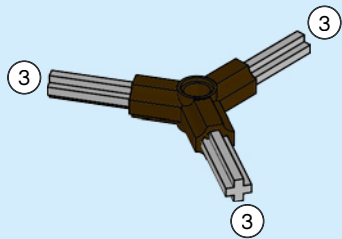



1x



3x

# 12

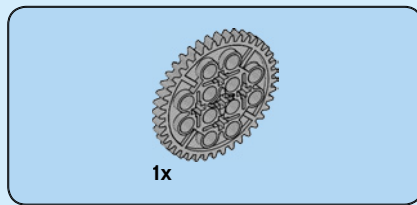
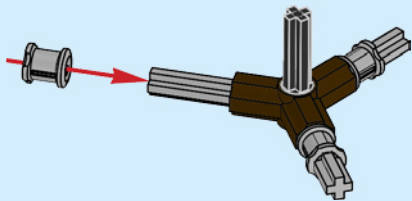

1x

# 13

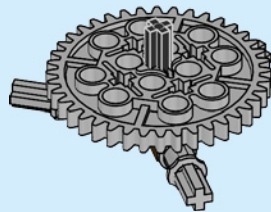

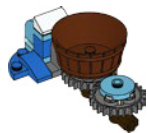

3x



1x

14

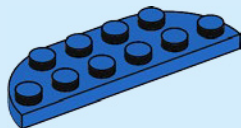

1x



1x

15

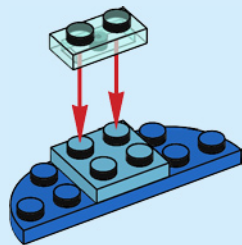

1x

16

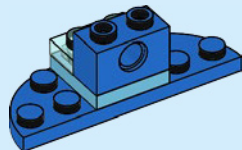



1x



1x

17

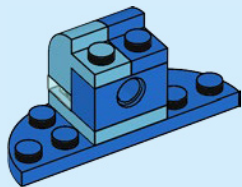

1x



1x

18

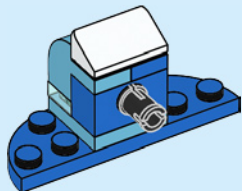

1x

19

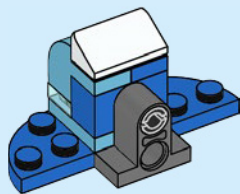

1x



1x

20

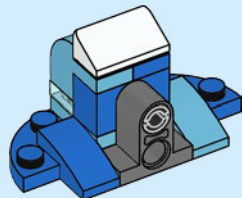

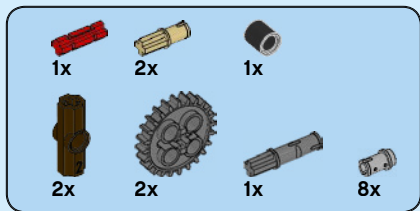

21 1

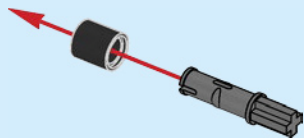

2

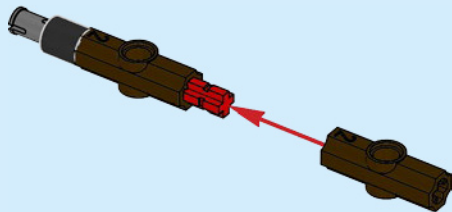

3

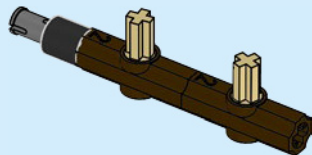

4

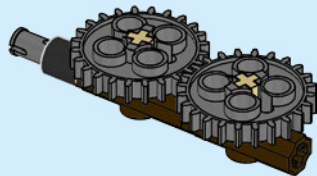

5

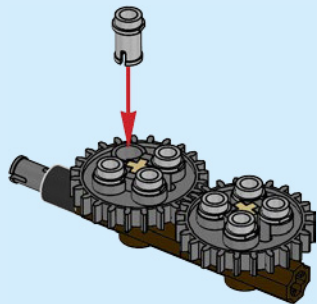

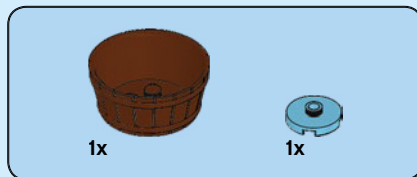
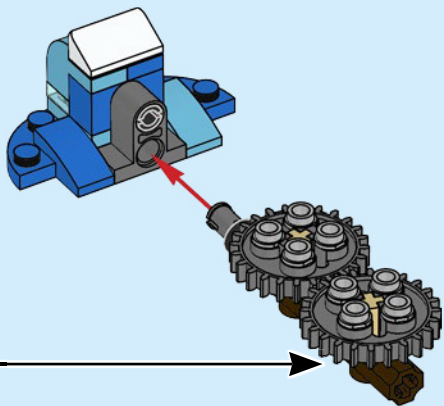

22

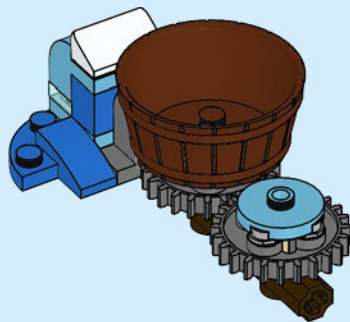

3x

23

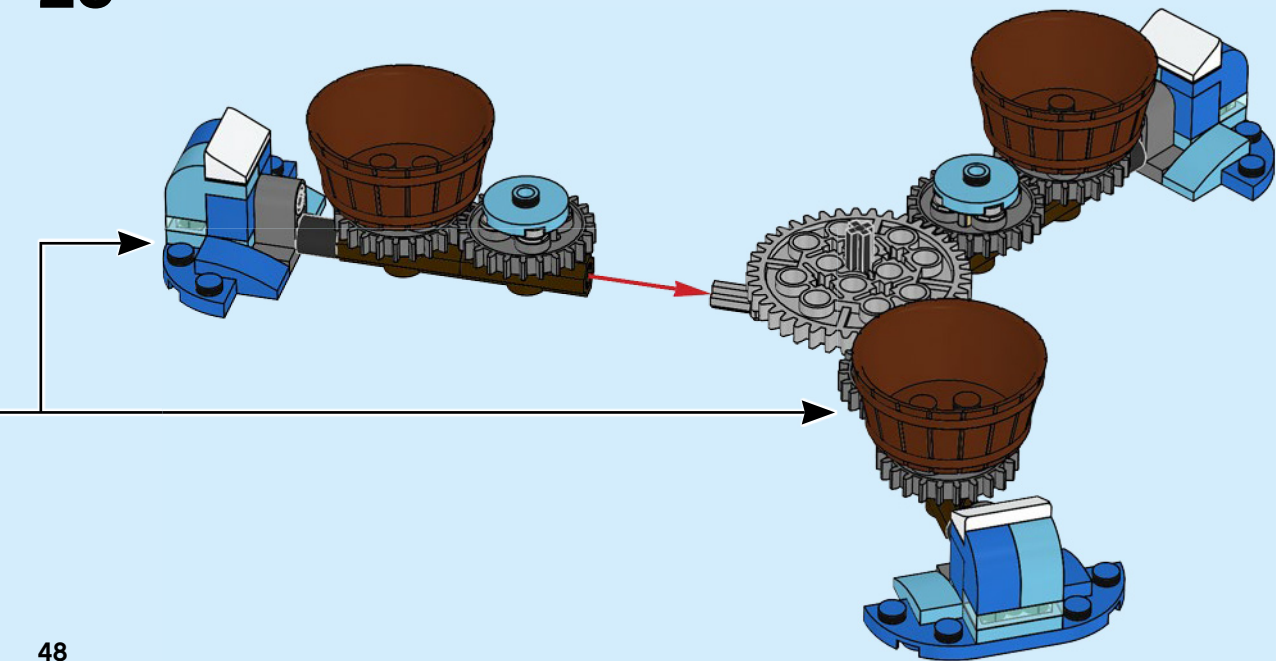



24

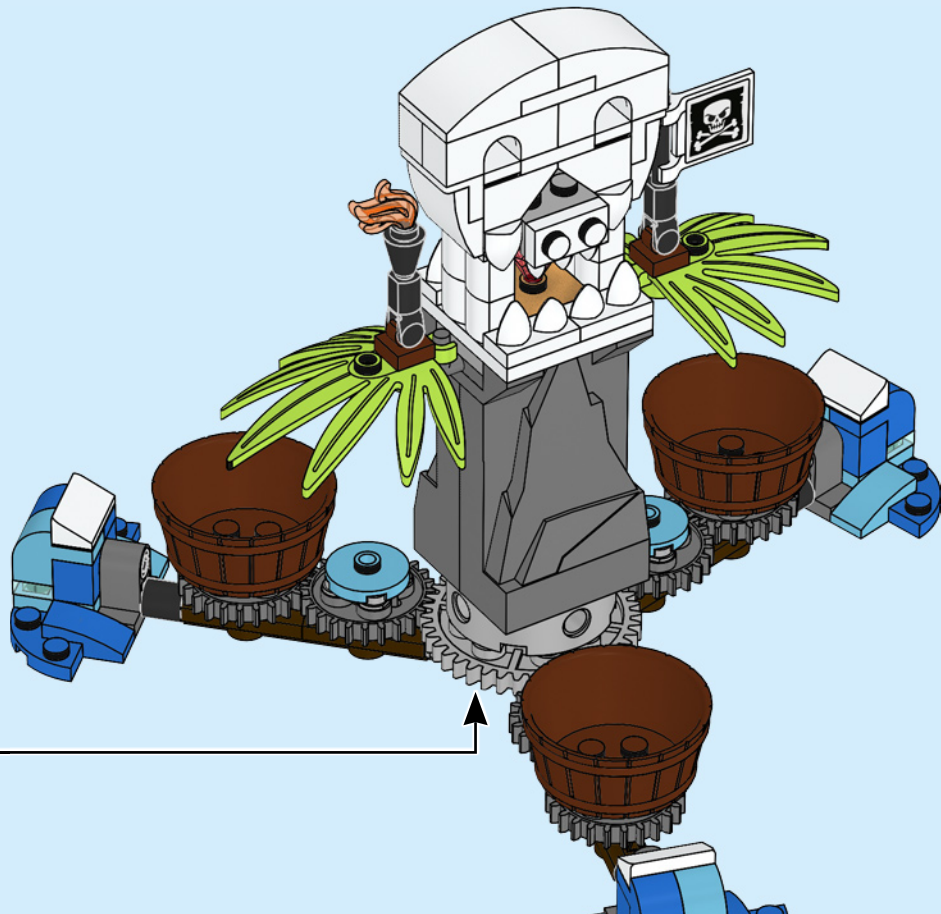

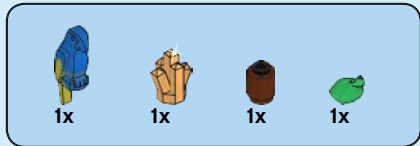

25



