

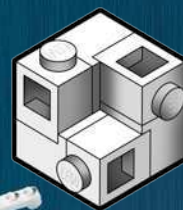

CREATOR™



EXPERT

10268

Booklet available in English on
Heft in deutscher Sprache erhältlich auf
Livret disponible en français sur
Libretto disponibile in italiano su
Folleto disponible en español en
Folheto disponível em português em
A füzet magyarul ezen a honlapon olvasható:
Buklets latviešu valodā pieejams vietnē
如需中文版手册, 请访问



LEGO.com/creatorexpert

Vestas
vestas.com





Building Up Wind Power

At the LEGO Group, we want to make a positive impact on the world around us. We have committed to making all LEGO® bricks using sustainable materials by 2030 via our Planet Promise, our roadmap to achieving our sustainability goals. Through investments in wind power we have achieved our ambition to balance 100% of the energy we use to make LEGO bricks with energy from renewable sources.

This is why the launch of this wind turbine model is very important to us. Developed in close collaboration with Vestas, the global front-runner in sustainable wind energy, this is also the first Creator Expert model to include LEGO elements from sustainably sourced, plant-based plastic.

So we like to think that this LEGO Vestas Wind Turbine is a small tribute to the innovators of the past and the builders of tomorrow. It's a desktop-sized representation of not only Vestas' technological innovation, but also of the power and potential of sustainability, commitment and collaboration.

In this booklet, we've included some facts about wind energy and our LEGO initiatives focused on sustainability. Find out more about our sustainability commitment at LEGO.com/responsibility-story.

We hope you enjoy building this model as much as we have enjoyed developing it!

Pioneering Sustainable Energy

In the late 1970s during what's now known as the second oil crisis, a small number of engineers were hard at work in a little factory in Western Jutland. The work was carried out in secret, not because they knew their work would change how the world was powered in the future, but because very few believed in their idea. That idea, to harness the power of the wind to produce sustainable energy, was in fact very far from the primary product of their company, Vestas, at the time: kitchen appliances and agricultural machinery.

But the engineers were persistent, and through imagination, experimentation, commitment and collaboration, they and Vestas endeavoured to make their unbelievable idea believable. And so, after several failed attempts, Vestas installed its first wind turbine in 1979 based on the three-bladed design that today still dominates wind energy and is referred to as "the Danish concept".

Since then, both Vestas and wind energy have evolved tremendously together. While Vestas' first wind turbine had a rotor diameter of 32 ft. (10m) and a capacity of 30 kW, today's turbines are several hundred times more powerful, with rotors of more than 492 ft. (150m) in diameter. During this time, wind turbines have gone from being an experiment in a windy part of Denmark to becoming the cheapest source of electricity in markets all over the world.

Today, Vestas and wind energy have changed the global energy landscape, and as the leader within sustainable energy, Vestas has pioneered wind energy in all parts of the world. Wind energy and other sustainable energy sources are overtaking traditional energy sources, and Vestas continues to develop the solutions that will ensure a healthy world for future generations. The journey has just begun, and the imagination, experimentation, collaboration and commitment to the unbelievable that brought the first wind turbines to life, continues to drive Vestas and sustainable energy forward.

About Vestas

Founded in Denmark in the late 19th century, Vestas drives the green transition forward as the world leader in sustainable energy solutions. We design, manufacture, install, and service wind turbines on six continents and have pioneered wind energy in more countries than anyone else. Today, wind energy powers 170 million homes, and as the world continues the transition to sustainable energy, Vestas leads innovation that combines wind energy with other energy sources to ensure a clean, stable energy supply for everyone.

A close-up, low-angle shot of a white wind turbine nacelle against a clear blue sky. The nacelle is the central housing for the generator and gearbox. The word "Vestas" is printed in a bold, blue, sans-serif font on the side of the nacelle, with a registered trademark symbol (®) to its upper right. The nacelle's surface is smooth with some rivets visible. In the background, the dark, vertical blades of the turbine are visible through the open top of the nacelle. The lighting is bright, suggesting a clear day.

Vestas®





Why Wind Power?

Tomorrow's energy needs are foreseeable and they will impact all aspects of life. But as energy consumption soars, how will we meet this demand? Fossil fuels are a finite resource that will gradually disappear. The natural replacement is sweeping freely around the Earth. Wind. It's renewable, predictable, fast to install, clean and cheap.

A wind turbine produces energy, pure and simple, and is already today the cheapest source of energy in many countries. And unlike oil, natural gas and other non-renewable materials, the price of wind is predictable, stable, and free in every currency.

Wind energy produces no CO₂, no other greenhouse gases and doesn't consume water, a scarce resource in itself. In fact, a wind turbine can generate 25 to 50 times more energy than it uses in its entire lifecycle, and it is only responsible for emission of around one percent of CO₂ compared to a conventional coal power plant.

Wind knows no limits, nor does it recognize national boundaries. It's an unlimited form of energy, and it's found freely in countries with even the poorest natural resources. Wherever it blows, it can bring jobs to support the local economy while lowering dependence on energy imports.

How does it all work?

Wind Energy Basics

Like all other weather and climate occurrences on the planet, wind stems from the sun. When the sun unevenly heats the irregular surface of the Earth's atmosphere as it rotates, wind is created. The motion energy caused by the movement of air over the Earth's terrain is called wind flow.

Wind power uses the Earth's atmosphere's natural airflows to produce electricity. To do so, the wind turbine blades capture the wind's kinetic energy, which makes the rotor spin, creating mechanical energy. The rotor turns an internal shaft, which is connected to the gearbox, which again changes the rotations from low-speed to high-speed. The high-speed shaft is connected to the generator, which creates electricity.

Each wind turbine is designed for different wind conditions, and wind turbines are carefully positioned based on numerous factors such as average wind speeds, landscape and turbulence. By choosing the right location and the right turbine for each site, wind turbines harness energy in the most efficient way.

Once generated by the wind turbine, the electricity is transmitted through underground cables called the transmission line to a grid substation where the voltage is adapted and connected to the grid. From there, the electricity travels through cables into our homes.

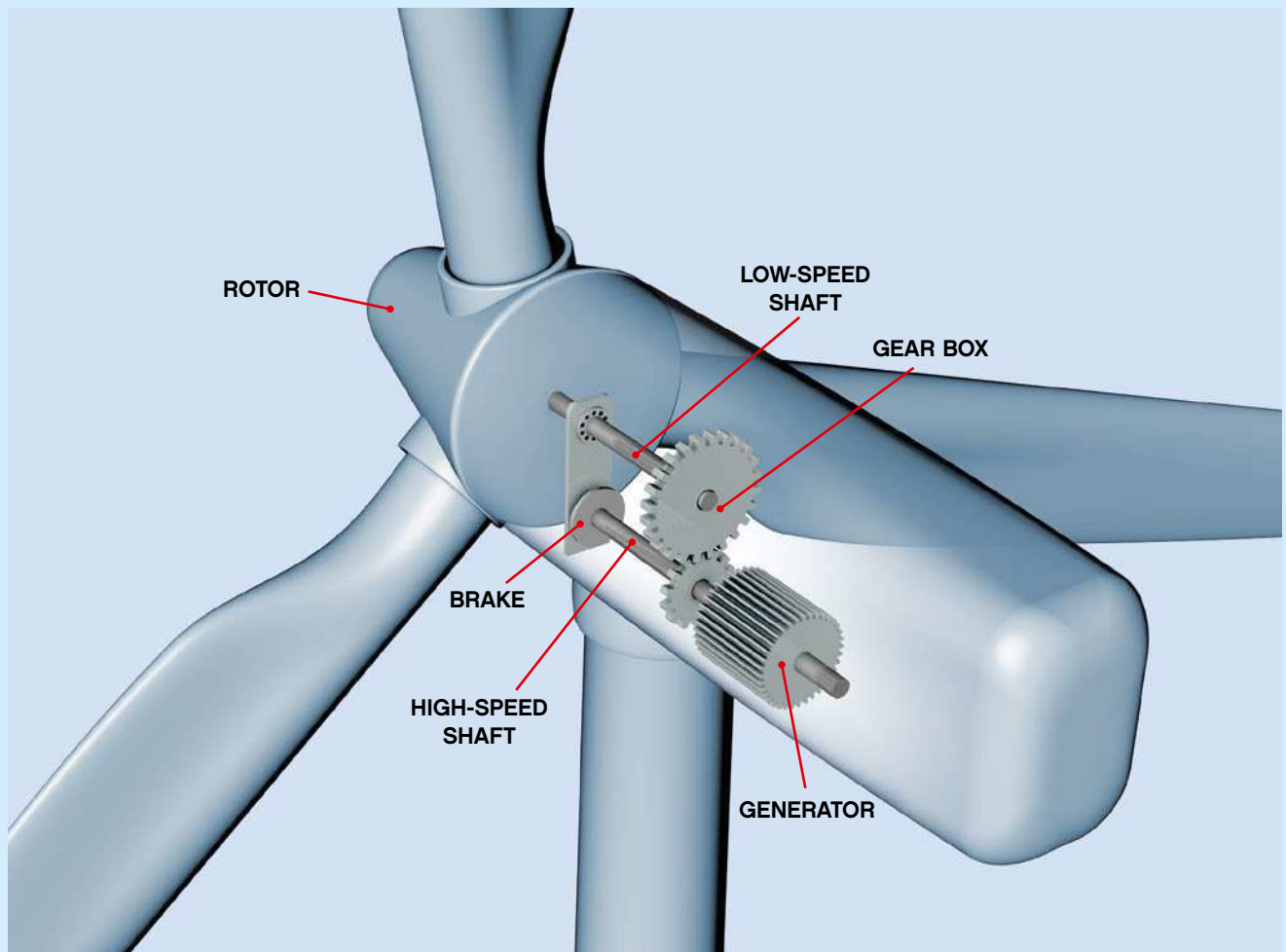



This particular element is found in the LEGO® Vestas Wind Turbine.

Plants from Plants

The Vestas Wind Turbine features LEGO® tree elements made from plant-based plastic. Moving forward, LEGO botanical elements such as leaves, bushes and trees will all be made from this plant-based plastic, as part of our commitment to using sustainable materials in core products by 2030 and in packaging by 2025.

These new LEGO plant-based elements are derived from sugarcane. The material is identical to the plastic used in older bricks, but is produced from sustainable sources. As always, any two LEGO bricks can fit together – even if they are made from different materials, decades apart.

Find out more at [LEGO.com/responsibility-story](https://www.lego.com/responsibility-story)

- Making It Real

As part of our mission, we have made a Planet Promise, built on the idea of leaving a positive impact on the world and future generations. Our biggest contribution to society is to inspire learning through play and help children realize their full potential. We strive to do so while safeguarding natural resources and minimizing our environmental impact.

To achieve this, we:

- Work to reduce CO₂ emissions in our operations and supply chain
- Invest in renewable energy and sustainable materials
- Work to reduce and recycle waste, and
- Inspire children to imagine sustainable solutions to important environmental challenges.

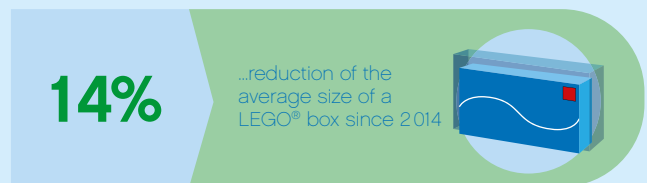

Wind Power Propels the LEGO Group

In 2017, we achieved our ambition to balance 100% of the energy we used to make LEGO® bricks with energy from renewable sources, three years ahead of schedule. Since 2012, the LEGO Group's parent company, KIRKBI A/S, has invested in the development of more than 160 megawatts of renewable energy generation, including wind farms in Germany and the UK.

The total energy output from investments in renewables is now greater than the energy consumed at all LEGO factories, stores and offices.



Vestas





+1,900 households

Can be powered every year, in Europe with only one **V90-2.0 MW™** Vestas wind turbine.

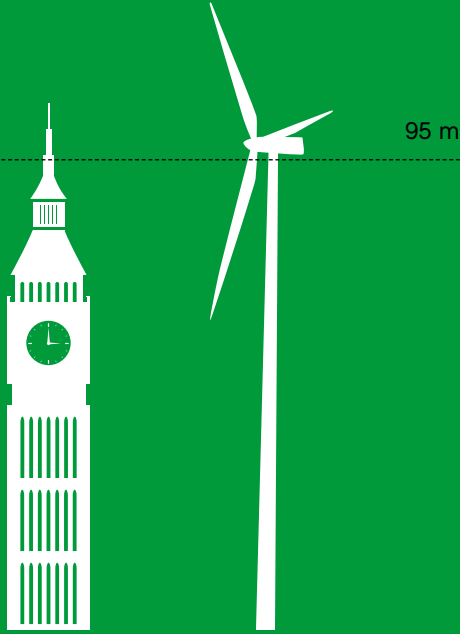

The hub of the Vestas V90-2.0™ turbine is approximately the same height, 314 ft. (96m), as the top tip of Big Ben in London.



+150 households

Can powered every year, with the current electricity consumption in Europe, with only one **V29-225 kW** Vestas wind turbine.

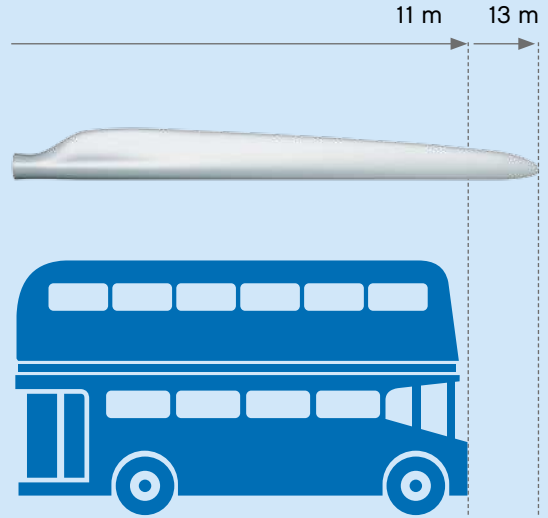

The length of the blades of the Vestas V29-225 kW turbine is 6 ft. (2m) longer than a London double-decker bus.



+4,700 households

Can be powered every year, in Europe with only one **V150-4.2 MW™** Vestas wind turbine.

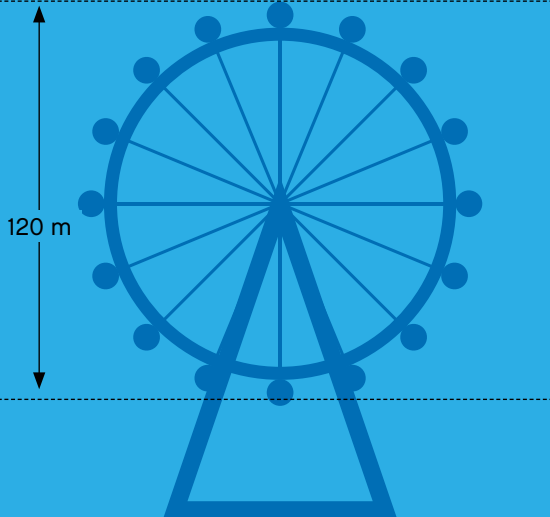

The rotor diameter of the Vestas V150-4.2 MV™ turbine is 98 ft. (30 m) larger than the rotor diameter of the London Eye, which is 393 ft. (120m).

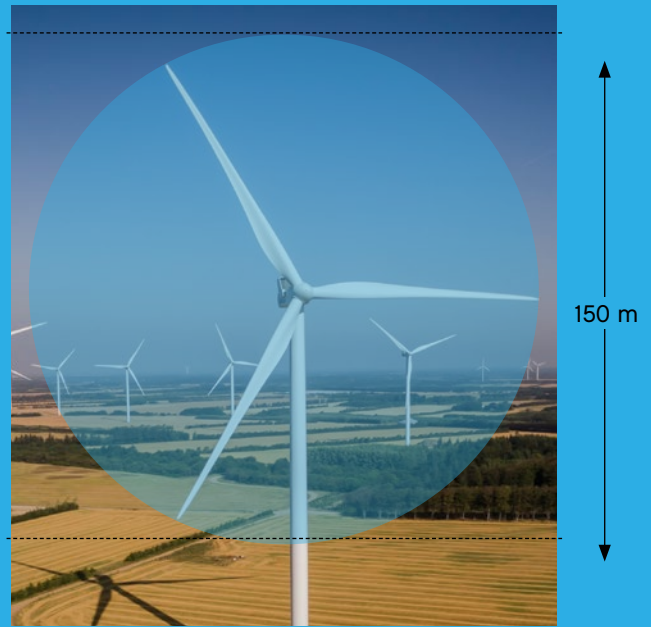



CREATOR™



LEGO.com/creatorexpert



EXPERT



10257

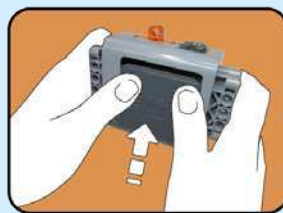
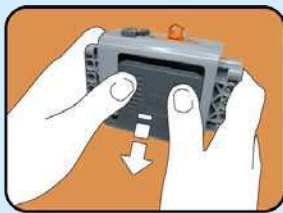

1.5 V LR 6 (AA)
1:1 X 6

EN

Save this leaflet because it contains important information.

Important information about batteries

Never use different types of batteries together, or a combination of old and new batteries. Always remove the batteries if the product is not to be used for a long time or if the batteries have run down. Never use damaged batteries. Only use batteries of the type recommended, or a corresponding type. Insert the batteries so that the poles are correctly positioned. Rechargeable batteries must be recharged using the correct battery charger under the supervision of an adult. You cannot recharge batteries while they are still in the product, and you must never try to do so. Never attempt to recharge non-rechargeable batteries. Never short-circuit the battery holder.

DE

Wichtige Informationen zu Batterien

Benutzen Sie niemals unterschiedlich Arten von Batterien oder alte und neue gleichzeitig. Nehmen Sie stets die Batterien heraus, wenn mit dem Modell längere Zeit nicht gespielt wird oder wenn die Batterien leer sind. Verwenden Sie niemals beschädigte Batterien. Verwenden Sie ausschließlich empfohlene bzw. geeignete Batterien. Achten Sie beim Einsetzen der Batterien auf die richtige Polung. Wiederaufladbare Batterien sollten mit einem geeigneten Ladegerät aufgeladen werden - unter der Aufsicht eines Erwachsenen. Wiederaufladbare Batterien können und sollten niemals aufgeladen werden, während sie sich im Modell befinden. Versuchen Sie unter keinen Umständen, „normale“ Batterien wieder aufzuladen. Schließen Sie das Batteriefach niemals kurz.

FR

Informations importantes concernant les piles

Ne jamais utiliser un mélange de différents types de piles, ou de piles neuves et de piles anciennes ou déjà utilisées. Toujours retirer les piles si le produit n'est pas utilisé durant une période prolongée ou si les piles sont vides. Ne jamais utiliser de piles endommagées. Utiliser uniquement des piles du type recommandé ou d'un type équivalent. En insérant les piles, respecter scrupuleusement le sens d'orientation des pôles (+/-). Les piles rechargeables doivent être rechargées en utilisant un chargeur de piles adéquat et sous la surveillance d'un adulte. Il est impossible de recharger les piles quand elles sont installées dans le produit. Ne jamais tenter de le faire. Ne jamais essayer de recharger des piles non-rechargeables. Ne jamais court-circuiter le compartiment des piles.

IT

Salvare questo foglio perché contiene importanti informazioni.

Importanti informazioni sulle batterie

Non usare mai contemporaneamente batterie di tipo diverso o batterie nuove e usate insieme. Rimuovere sempre le batterie qualora il prodotto non venga utilizzato per periodi prolungati, oppure se le batterie sono esauste. Non utilizzare mai batterie danneggiate. Usare esclusivamente batterie del tipo raccomandato o un equivalente. Inserire le batterie avendo cura che la loro polarità sia corretta. Le batterie ricaricabili vanno ricaricate in un caricabatterie di tipo idoneo e con la supervisione di un adulto. Non è possibile e non bisogna mai tentare di ricaricare le batterie mentre queste sono inserite nel prodotto. Non tentare mai di ricaricare batterie non ricaricabili. Non cortocircuitare mai il portabatterie.

NL

Belangrijke informatie over batterijen

Gebruik nooit verschillende soorten of een combinatie van oude en nieuwe batterijen tegelijkertijd. Verwijder de batterijen altijd als je het product lange tijd niet wilt gebruiken of als batterijen leeg zijn. Gebruik nooit beschadigde batterijen. Gebruik uitsluitend batterijen van het aanbevolen type of een overeenkomstig type. Plaats de batterijen met de polen in de juiste richting. Opladbare batterijen moeten in een voor dit doel bestemde oplader en onder toezicht van een volwassene opnieuw worden opgeladen. Opladbare batterijen kunnen niet worden opgeladen terwijl ze zich nog in het product bevinden en dit mag ook nooit worden geprobeerd. Probeer nooit niet-oplaadbare batterijen opnieuw op te laden. Laat de batterijhouder nooit kortsluiten.

ES

Información importante acerca de las pilas

No use pilas de diferentes tipos ni pilas nuevas y antiguas para alimentar el producto. Extraiga las pilas del producto si este va a permanecer sin uso durante un período prolongado de tiempo o aquellas se han agotado. No use pilas dañadas. Use sólo pilas del tipo recomendado u otro equivalente. Inserte las pilas de modo que los polos queden situados en las posiciones correctas. La carga de pilas recargables debe tener lugar empleando un cargador apropiado y bajo la supervisión de un adulto. Las pilas recargables no se pueden cargar mientras permanecen insertadas en el producto; no intente hacerlo. No trate de cargar pilas no recargables. No cortocircuite el compartimento de las pilas.

DA

Vigtige oplysninger om batterier

Brug aldrig forskellige batterityper sammen eller en kombination af gamle og nye batterier. Fjern altid batterierne, hvis produktet ikke skal bruges i lang tid, eller hvis batterierne er flade. Brug aldrig beskadigede batterier. Brug kun den anbefalede type batterier eller en tilsvarende type. Sæt batterierne i, så polerne vender den rigtige vej. Genopladelige batterier skal oplades i den rigtige batterioplader. Batterierne skal sættes i opladeren under opsyn af en voksen. Batterierne kan ikke oplades, mens de stadig sidder i produktet, og man må aldrig forsøge at gøre det. Forsøg aldrig at oplade ikke-genopladelige batterier. Kortslut aldrig batteriholderen.

IS

Mikilvægar upplýsingar um rafhlöður

Aldrei skal nota mismunandi gerðir rafhlaðna samtímis, né nýjar og eldri rafhlöður samtímis. Ef ekki á að nota tækið í lengri tíma eða ef rafhlöðurnar eru örðnar tómar skal fjarlægja rafhlöðurnar. Aldrei skal nota rafhlöður sem hafa skemmt. Aðeins skal nota rafhlöður af þeirri gerð sem mælt er með, eða samsvarandi gerð. Setja skal rafhlöðurnar í þannig að ++ og -skaut þeirra snúi rétt. Endurhlaðanlegar rafhlöður skal endurhlaða með réttu hleðslutæki undir eftirliti fullorðinna. Rafhlöður er ekki hægt að endurhlaða á meðan þær eru enn í vórinni og það má aldrei reyna að gera það. Aldrei skal reyna að endurhlaða rafhlöður sem ekki eru endurhlaðanlegar. Aldrei ætti að valda skammhlaupi í rafhlöðuhöfninu.

FI

Tärkeää tietoa paristoista

Älä koskaan käytä erityyppisiä paristoja yhdessä. Älä myöskään käytä samassa laitteessa sekä vanhoja että uusia paristoja. Poista paristot tuotteesta aina, kun se on pitemmän aikaa käyttämättä, tai kun paristot ovat tyhjentyneet. Älä koskaan käytä viallisia paristoja. Käytä vain tuotteessa suositeltuja tai vastaaventyyppisiä paristoja. Aseta paristot siten, että navat osoittavat oikeaan suuntaan. Ladattavat paristot on ladattava oikeanlaisella laturilla aikuisen valvonnassa. Ne on poistettava tuotteesta lataamisen ajaksi. Älä koskaan yritä ladata paristoja, joita ei ole tarkoitettu ladattaviksi. Älä koskaan aiheuta oikosulkua pariston kosketinten välillä.

SV

Viktig information om batterier

Använd aldrig olika sorters batterier samtidigt, och inte heller en kombination av gamla och nya batterier. Ta alltid ur batterierna om produkten inte ska användas under en längre tid eller om batterierna är slut. Använd aldrig skadade batterier. Använd bara batterier av den typ som rekommenderas, eller av en motsvarande typ. Sätt i batterierna så att polerna hamnar i rätt läge. Laddningsbara batterier måste laddas med rätt slags batteriladdare och under en vuxens överinseende. Du kan inte ladda batterierna medan de fortfarande sitter i produkten, och du får heller aldrig försöka göra det. Försök aldrig ladda icke laddningsbara batterier. Kortslut aldrig batteriutrymmets kontaktytor.

NO

Viktig informasjon om batterier

Bruk aldri ulike typer batterier sammen og heller aldri gamle og nye batterier sammen. Ta alltid ut batteriene hvis produktet ikke skal brukes på lang tid, eller hvis batteriene er brukt opp. Bruk aldri skadde batterier. Bruk kun anbefalt type batterier eller tilsvarende type. Sett inn batteriene med polene vendt riktig vei. Oppladbare batterier skal lades opp med riktig batterilader, under overoppsyn av en voksen. Det er ikke mulig å lade opp batteriene mens de fremdeles er i produktet, og du må aldri forsøke å gjøre det. Forsøk aldri å lade opp ikke-oppladbare batterier. Kortslett aldri batteriholderen.

PT

Guardar este folheto por conter informações importantes.

Informação importante sobre as pilhas

Nunca use diferentes tipos de pilhas em simultâneo, ou uma combinação de pilhas usadas e novas. Retire sempre as pilhas se o produto não for usado durante muito tempo ou se as pilhas já não tiverem carga. Nunca use pilhas danificadas. Use apenas pilhas do tipo recomendado ou de um tipo correspondente. Insira as pilhas de forma a que os pólos fiquem corretamente posicionados. As pilhas recarregáveis devem ser recarregadas com o carregador de pilhas correto e sob a supervisão de um adulto. Não pode recarregar as pilhas enquanto as mesmas se encontram colocadas no produto e nunca deve tentar fazê-lo. Nunca tente recarregar pilhas não recarregáveis. Nunca deixe o compartimento das pilhas entrar em curto-circuito.

EL

Σημαντικές πληροφορίες για τις μπαταρίες
Μην χρησιμοποιείτε ποτέ διαφορετικούς τύπους μπαταριών μαζί και μην συνδυάζετε παλιές και καινούριες μπαταρίες. Αφαιρείτε πάντα τις μπαταρίες αν δεν σκοπεύετε να χρησιμοποιήσετε το προϊόν για αρκετό καιρό ή αν οι μπαταρίες έχουν αδειάσει. Ποτέ μην χρησιμοποιείτε μπαταρίες που έχουν φθορές. Χρησιμοποιείτε μόνο μπαταρίες του συνιστώμενου τύπου ή κάποιοι αντίστοιχου τύπου. Τοποθετήστε τις μπαταρίες με τους πόλους στη σωστή θέση. Οι επαναφορτιζόμενες μπαταρίες πρέπει να επαναφορτίζονται χρησιμοποιώντας το σωστό φορτιστή μπαταριών υπό την επίβλεψη ενήλικου. Δεν μπορείτε να επαναφορτίσετε τις μπαταρίες όταν αυτές βρίσκονται μέσα στο προϊόν και δεν πρέπει ποτέ να δοκιμάσετε κάτι τέτοιο. Μην επιχειρήσετε ποτέ να επαναφορτίσετε μη επαναφορτιζόμενες μπαταρίες. Ποτέ μην βραχυκυκλώνετε τη θήκη των μπαταριών.

JA

電池取扱いに関する重要事項

異なるタイプの電池や古い電池を混ぜて使用しないでください。商品を長時間使用しないときや電池が切れたときは、電池を必ず取り外してください。不具合のある電池は絶対に使用しないでください。推奨されているタイプまたは対応しているタイプの電池を必ず使用してください。電極を確認して電池を正しい向きに入れてください。充電式電池は、保護者に見てもらった上で適切な充電器を使って充電してください。電池を商品の中に入れてまま充電することは絶対に避けてください。充電式ではない電池は絶対に充電しないでください。電池ホルダをショートさせないでください。

ZH

该包装含重要信息应保留。

关于电池的重要信息

请勿同时使用不同类型的电池，或把新旧程度不同的电池混合使用。如果产品将有很长时间不会使用，或者电池已经没电，请注意取出电池。切勿使用已破损的电池。务必仅使用推荐类型或兼容类型的电池。装入电池时请注意正负极。如果使用充电电池，务必在成人监护下使用正确的电池充电器进行充电。电池仍在产品中时不可进行充电，请勿强行尝试充电。请勿尝试给非充电电池充电。切勿对电池仓进行短路连接。

KO

배터리 사용 시 주의사항
다른 종류의 배터리를 함께 사용하거나, 새 전지와 오래된 전지를 혼용하지 마세요. 배터리가 방전되었거나 장기간 제품을 작동하지 않을 때에는 반드시 배터리를 분리하세요. 파손된 배터리는 사용하지 마세요. 레고에서 권장하는 유형의 배터리만 사용하세요. 양극과 음극의 위치를 잘 맞춰서 넣으세요. 어른의 감독에 따라 지정된 충전기에 충전지를 충전해야 합니다. 충전지를 제품에 넣은 상태로 충전하면 안 됩니다. 일반 배터리는 충전해서 사용할 수 없습니다. 배터리 홀더의 접촉부에 배터리를 정확히 끼워서 사용하세요.

RU

Необходимая информация об элементах питания

Ни в коем случае не используйте одновременно элементы питания различных типов, а также элементы питания с разным сроком годности. В обязательном порядке вынимайте элементы питания из терминалов в случае, если вы не пользуетесь прибором в течение долгого времени, либо в случае, если в элементах питания закончился заряд. Ни в коем случае не используйте поврежденные элементы питания. Используйте только рекомендуемые элементы питания либо элементы питания соответствующего типа. Установите элементы питания, соблюдая указанную полярность. Аккумуляторные элементы питания должны подзаряжаться в соответствующем зарядном устройстве под наблюдением взрослого. Ни в коем случае не пытайтесь подзаряжать элементы питания, находящиеся в приборе. Ни в коем случае не пытайтесь подзаряжать непerezаряжаемые элементы питания. Ни в коем случае не пытайтесь замкнуть полюса в устройстве для элементов питания.

PL

Ważne informacje dotyczące baterii

Nigdy nie należy stosować razem różnych rodzajów baterii ani stosować równocześnie starych i nowych baterii. Jeżeli produkt nie jest używany przez dłuższy czas lub jeżeli baterie się wyczerpały, należy wyjąć baterie. Nigdy nie należy stosować uszkodzonych baterii. Należy stosować wyłącznie zalecany rodzaj baterii lub rodzaj mu odpowiadający. Przy wkładaniu baterii należy zwrócić uwagę na właściwe położenie biegunów. Baterie akumulatorowe należy ładować w odpowiedniej ładowarce pod nadzorem osoby dorosłej. Nie można naładować baterii bez wyjęcia ich z produktu i nigdy nie należy tego próbować. Nigdy nie należy próbować ładowania baterii jednorazowych. Nigdy nie należy doprowadzać do zwarcia w gnieździe baterii.

CZ

Důležitá informace o bateriích

Nikdy nepoužívejte najednou různé typy baterií nebo kombinaci starých a nových baterií. Nebude-li se výrobek delší dobu používat nebo jsou-li baterie vybité, vždy je vyjměte z výrobku. Nikdy nepoužívejte poškozené baterie. Používejte pouze doporučené nebo odpovídající typy baterií. Baterie instalujte se správnou orientací pólů. Nabíjitelné baterie musí být nabitý ve vhodné nabíječe pod dohledem dospělé osoby. Nabíjitelné baterie nelze nabíjet, jsou-li umístěny ve výrobku, a nesmíte se o to ani pokoušet. Nikdy se nesnažte nabíjet baterie, které nejsou nabíjitelné. Nikdy nezkratujte kontakty v prostoru pro baterie.

SK

Dôležitá informácia o batériách

Nikdy nepoužívajte naraz odlišné typy batérií ani nekombinujte staré batérie s novými. Batérie vždy vyberte, ak sa výrobok nebude dlhšie používať, alebo ak sa batérie vybili. Nikdy nepoužívajte poškodené batérie. Používajte jen odporúčané alebo zodpovedajúce typy batérií. Batérie vkladajte so správnou orientáciou pólov. Nabíjateľné batérie sa musia nabíjať vo vhodnej nabíjačke pod dozorom dospeljej osoby. Nabíjateľné batérie sa nesmú nabíjať, ak sú umiestnené vo výrobku, a nesmiete sa o to ani pokúšať. Nikdy sa nesnažte nabíjať batérie, ktoré nie sú nabíjateľné. Nikdy neskratuje kontakty v priestore pre batérie.

HU

Fontos tudnivalók az elemekről

Soha ne használjon különböző típusú elemeket, illetve ne használjon vegyesen új és használt elemeket. Mindig távolítsa el az elemeket, ha a készüléket előrére láthatóan hosszabb ideig nem fogják használni, vagy ha az elemek lemerültek. Soha ne használjon megrongálódott elemeket. Csak az ajánlott típusú, vagy annak megfelelő elemet használjon. Az elemeket helyesen helyezze be, a polaritásuknak megfelelően. Az akkumulátorokat csak a megfelelő akkumulátor- töltővel szabad feltölteni, felöltő felügyelete mellett. Az akkumulá- torokat nem lehet feltölteni, ha azok a készülékben vannak. Ezt meg sem szabad próbálni. Soha ne próbálja meg feltölteni a nem tölthető elemeket. Soha ne hozzon létre rövidzárlatot az elemtartó kivezetéséin.

UA

Необхідна інформація про батарейки

Ніколи не використовуйте одночасно батарейки різних типів або батарейки з різних терміном придатності. Обов'язково вилучайте батарейки з приладу, якщо довго не користуетесь ним, або якщо в батарейках вже скінчився заряд. Ніколи не використовуйте пошкоджені батарейки. Використовуйте батарейки лише рекомендованого або відповідного типу. Вставляйте батарейки, враховуючи задану полярність. Акумуляторні батарейки повинні заряджатись у відповідному зарядному приладі під наглядом дорослого. В будь-якому випадку не намагайтеся підзарядити батарейки, що знаходяться в приладі. В будь-якому випадку не намагайтеся підзарядити батарейки, що не підлягають підзарядці. В будь-якому випадку не намагайтеся зробити коротке замикання в приладі для батареї.

HR

Važne obavijesti o bateriji

Nikada nemoj koristiti različite vrste baterija zajedno, isto tako ni kombinaciju starih i novih baterija. Uvijek izvadi baterije ako dugo nećeš koristiti proizvod ili ako su one potrošene. Nikada nemoj koristiti oštećene baterije. Koristi samo preporučenu vrstu ili odgovarajuću vrstu baterija. Umetni baterije pazeci da dobro okreneš polove. Akumulatorske se baterije moraju puniti uz pomoć propisanog punjača i uz nadzor odrasle osobe. Baterije se ne smiju puniti dok su još u proizvod i to nikada nemoj pokušavati. Nikada ne pokušavaj puniti baterije koje nisu predviđene za punjenje. Nikada ne izazivaj kratki spoj u držaču baterija.

SR

Važne informacije o baterijama

Nikada ne koristite različite tipove baterija zajedno niti kombinaciju starih i novih baterija. Uvek izvadite baterije ukoliko proizvod nećete duže vreme koristiti ili ukoliko su baterije prazne. Nikada ne koristite oštećene baterije. Upotrebljavajte samo preporučeni tip baterija ili odgovarajuću zamenу. Stavite baterije tako da su polovi pravilno pozicionisani. Baterije na punjeње se moraju puniti odgovarajućim punjačem pod nadzorom odraslog lića. Niје moguće puniti baterije dok su u proizvodu i nikad ne pokušavajte da radite to. Nikada ne pokušavajte da punitе baterije koje ne mogu da se pune. Nikada ne izazivajte kratak spoj u kućiшту za baterije.

МК

Vажни информации за батериите

Никога не користете различни типови батерији заедно или комбинација од стари и нови батерији. Секогаш отстранувајте ги батериите доколку не го користите производот подолго време или доколку се потрошиле. Никога не користете оштетени батерији. Користете ги само препорачаните батерији или батерији од соодветен тип. Вметнете ги батериите така што точно ќе ги наместите половите. Батериите на полнење мора да се полнат со соодветниот полнач под надзор на возрастано лице. Не може да ги полните батериите додека сè уште се наоѓаат во производот и никогаш не смеете да го правите тоа. Никога не обидувајте се да ги полните батериите за еднократна употреба. Никога не предизвикувајте краток spoj на држачот за батерији.

SL

Pomembne informacije o baterijah

Nikoli ne uporabljajte skupaj različnih baterij ali kombinacije starih in novih baterij. Vedno odstranite baterije, če izdelka dlje časa ne boste uporabljali ali če so iztrošene. Nikoli ne uporabljajte poškodovanih baterij. Uporabljajte le baterije priporočene ali ustreznega tipa. Baterije vstavite tako, da so njihovi polji pravilno obrnjeni. Akumulatorske baterije je treba polniti s pravim polnilnikom pod nadzorom odrasle osebe. Akumulatorskih baterij ni mogoče polniti, dokler so še v izdelku. Tega tudi ne smete poskušati. Nikoli ne poskušajte polniti baterij, ki niso akumulatorske. Pazite, da ležišč za baterije ne boste spravili v kratek stik.

RO

Informații importante despre baterii

Nu folosiți niciodată împreună tipuri diferite de baterii, sau o combinație de baterii vechi și noi. Îndepărtați întotdeauna bateriile dacă produsul nu este folosit timp îndelungat sau dacă bateriile s-au epuizat. Nu folosiți niciodată baterii deteriorate. Folosiți numai baterii de tipul recomandat, sau un tip corespunzător. Introduceți bateriile astfel ca polii să fie poziționați corect. Bateriile reincărcabile trebuie reincărcate utilizând încărcătorul corect sub supravegherea unui adult. Nu puteți reincărca bateriile în timp ce acestea sunt încă în produs, și niciodată nu trebuie să încercați să faceți acest lucru. Nu încercați niciodată să reincărcați baterii nereincărcabile. Nu scurcircuitați niciodată suportul bateriei.

BG

Важна информация за батериите

Никога не използвайте едновременно различни типове батерији или комбинация от стари и нови батерији. Винаги изваждайте батериите, ако изделието няма да се използва продължително време или ако батериите са се изтозили. Никога не използвайте повредени батерији. Използвайте само батерији от препоръчвания тип или съответства на него тип. Поставете батериите така, че полюсите да са разположени правилно. Акумулаторните батерији трябва да се зареждат с подходящо зареждащо устройство под надзора на възрастни. Батериите не могат да се зареждат, докато са поставени в изделието, затова никога не опитвайте да правите това. Никога не опитвайте да зареждате батерији, които не са акумулаторни. Никога не свързвайте на късо контактите на отделението за батериите.

LV

Saglabājiet šo brošūru, jo tajā ir sniegta svarīga informācija.

Svarīga informācija par baterijām

Nekad vienlaikus nelietojiet dažādu tipu, kā arī vecas un jaunas baterijas. Vienmēr iznīemiet baterijas, ja tās ir izlādējušās vai ja produkts ilgāku laiku netiek lietots. Nekad nelietojiet bojātas baterijas. Lietojiet tikai ieteicamā tipa vai atbilstoša tipa baterijas. Ievietojiet baterijas, ievērojiet pareizu polaritāti. Uzlādējamu bateriju lādēšanai izmantojiet atbilstošu bateriju lādētāju; uzlāde jāveic pieaugušo uzraudzībā. Baterijas nevar uzlādēt un nekad nedrīkst mēģināt uzlādēt, kamēr tās ievietotas produktā. Nekad nemēģiniet uzlādēt baterijas, kas nav uzlādējamas. Nepieļaujiet issavienojumu bateriju nodalījumā.

ET

Oluline teave patareide kohta

Ära kunagi kasuta koos erinevat tüüpi patareisid, samuti vanu ja uusi patareisid. Kui märguasja ei kasutata pika aja jooksul, võta patarei sellest välja. Ära kunagi kasuta kahjustatud patareisid. Kasuta ainult ettenähtud tüüpi või nendega samaväärseid patareisid. Pane patareid märguasja sisse nii, et pluss- ja miinusklõmmi asend oleks õige. Akusid tuleb laadida ainult neile ettenähtud akulaadija abil täiskasvanu järelevalve all. Akusid ei saa laadida sel ajal, kui need on märguasja sees. Ära kunagi püüa nii teha. Ära kunagi proovi akulaadijaga laadida avalisi patareisid. Patareipesa klemmide vahel ei tohi tekkida lühis.

LT

Svarbi informacija apie elementus

Vienu metu nenaudokite skirtingų elementų, taip pat su naujais elementais nenaudokite senų. Jei nenaudosite gaminio ilgesnį laiką arba jei elementai išsekę, visuomet išimkite juos iš gaminio. Niekada nenaudokite pažeistų elementų. Naudokite tik rekomenduojamo arba atitinkamo tipo elementus. Elementus dėkite atsizvelgdami į jų poliškumą. Elementus galima įkrauti tik tinkamu krovikliu ir prižiūrint suaugusiųems. Jokiu būdu negalima, ir niekuomet nebandykite, įkrauti elementų neišėjus jų iš gaminio. Niekada nebandykite įkrauti vienkartinį elementų. Saugokitės, kad elementų įdėkle nesukeltumėte trumpojo jungimo.

TR

Piller hakkında önemli bilgiler

Hiçbir zaman farklı tipte pilleri ya da eski pillerle yeni pilleri bir arada kullanmayın. Ürün uzun süre kullanılmayacaksa ya da piller bitmişse, pilleri ürünün içinden çıkarın. Hiçbir zaman zedelenmiş piller kullanmayın. Sadece önerilen tipte piller ya da bunların dengi olan piller kullanın. Pilleri kutupları doğru konumda olacak şekilde yerleştirin. Şarj edilebilen pilleri doğru pil şarj aletini kullanarak, bir yetişkinin denetiminde şarj edin. Şarj edilebilen pilleri, pil ürünün içindeyken şarj edemezsiniz bunu hiçbir zaman yapmaya çalışmayın. Hiçbir zaman, şarj edilebilir olmayan pilleri şarj etmeye çalışmayın. Hiçbir zaman pil kutusuna kısa devre yaptırmayın.

AR

معلومات مهمة عن البطاريات

يُحظر استخدام أنواع مختلفة من

البطاريات معًا أو مزيج من البطاريات

القديمة والجديدة. احرص دائمًا على

نزع البطاريات في حال عدم استخدام

المنتج لفترة طويلة أو إذا نفذت طاقة

البطاريات. تجنب استخدام البطاريات

التالفة. لا تستخدم إلا نوع البطاريات

الموصى به أو نوع مماثل. قم بتركيب

البطاريات بحيث تكون الأقطاب في

موضعها الصحيح. يجب إعادة شحن

البطاريات القابلة لإعادة الشحن

باستخدام شاحن البطاريات المناسب

وذلك تحت إشراف شخص بالغ. لا يمكنك

إعادة شحن البطاريات وهي لا تزال داخل

المنتج. ويجب ألا تجرب فعل ذلك. يُحظر

إعادة شحن البطاريات غير القابلة لإعادة

الشحن. تجنب إحداث دائرة قصر في حامل

البطارية.

ID

Informasi penting tentang baterai

Jangan gunakan baterai yang jenisnya berlainan, atau mencampur baterai lama dan baterai baru. Lepas baterai jika produk tidak akan digunakan untuk waktu lama atau jika baterai sudah lemah. Jangan gunakan baterai yang rusak. Gunakan jenis baterai yang dianjurkan atau yang sejenis. Masukkan baterai dengan posisi kutub yang tepat. Baterai isi ulang harus diisi ulang dengan charger baterai yang sesuai dan di bawah pengawasan orang dewasa. Anda tidak dapat mengisi ulang baterai saat masih terpasang di dalam produk, dan jangan pernah coba melakukannya. Jangan pernah coba mengisi ulang baterai biasa. Jangan pernah membuat arus pendek pada dudukan baterai.

MS

Maklumat penting tentang bateri

Jangan guna jenis bateri yang berbeza bersama-sama, atau gabungan bateri baharu dan lama. Tanggalkan bateri jika produk tidak akan digunakan untuk tempoh masa yang lama atau jika bateri telah kehabisan kuasa. Jangan guna bateri yang rosak. Hanya guna jenis bateri yang disyorkan, atau jenis yang berkaitan. Selitkan bateri supaya supaya paksi berada pada kedudukan yang betul. Bateri yang boleh dicaskan semula perlu dicas semula menggunakan pengecas bateri yang betul bawah pengawasan orang dewasa. Anda tidak boleh mengecas bateri semasa bateri masih berada pada produk, dan anda jangan cuba berbuat demikian. Jangan cuba untuk mengecas semula bateri yang tidak boleh dicaskan semula. Jangan pintas litar pemegang bateri.

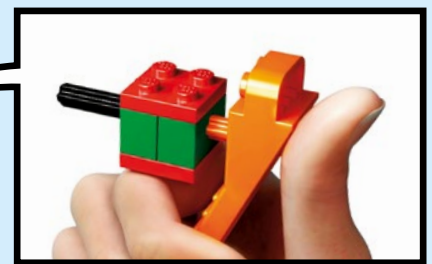
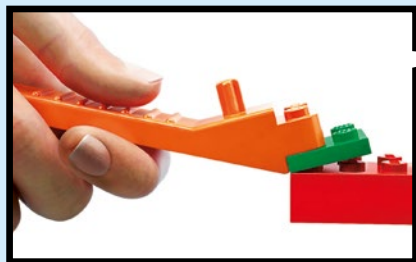

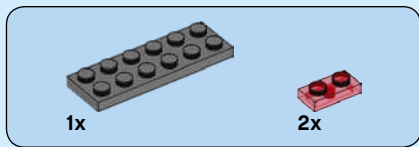
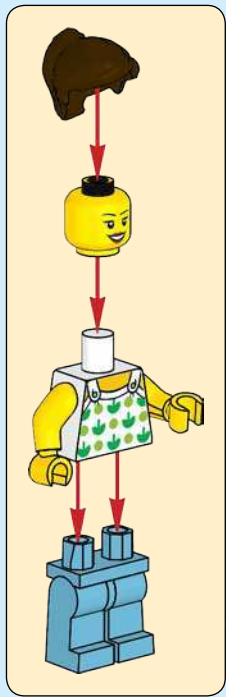

1

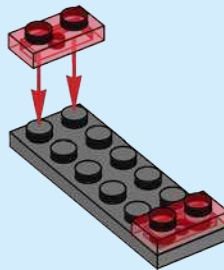

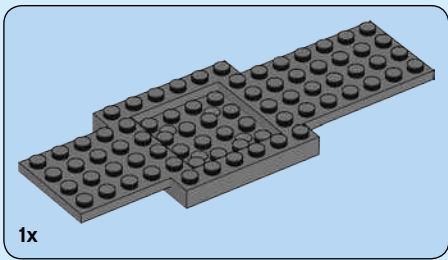

1x

2

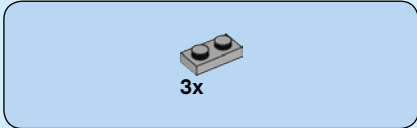
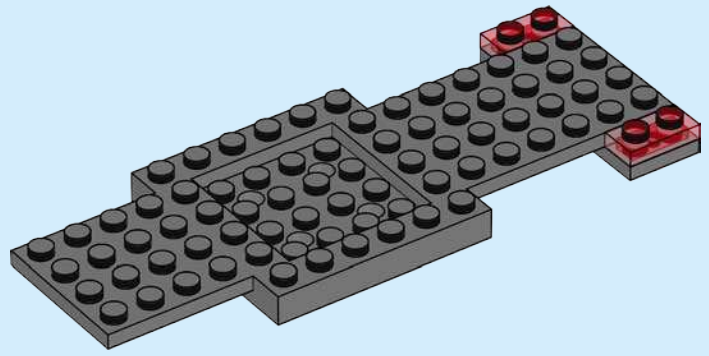

3x

3

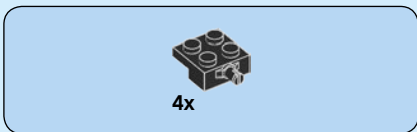
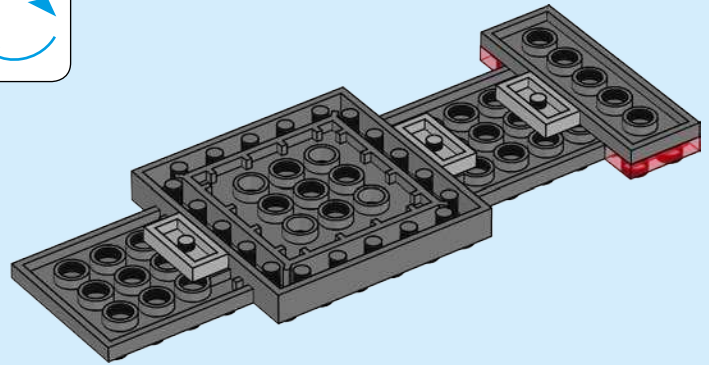
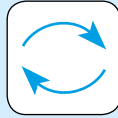

4x

4

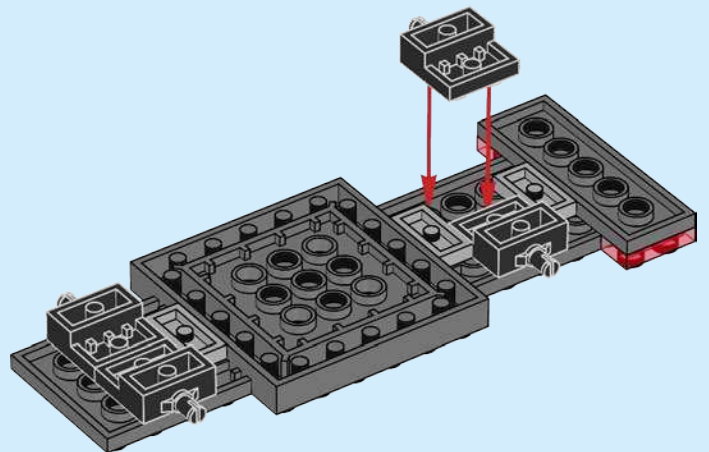

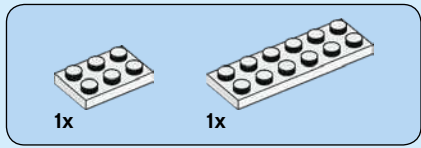

5

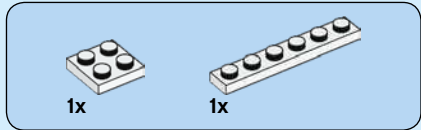
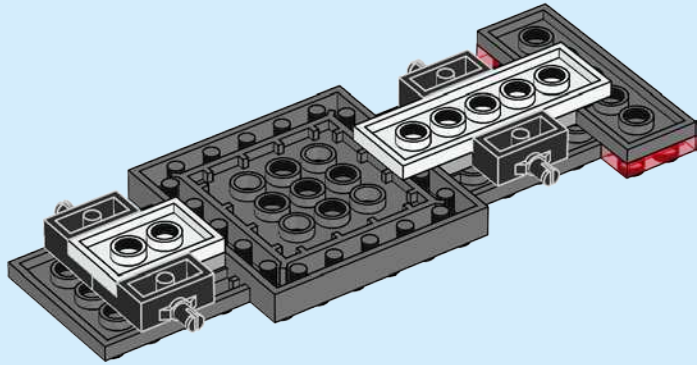

6

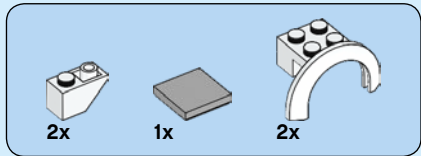
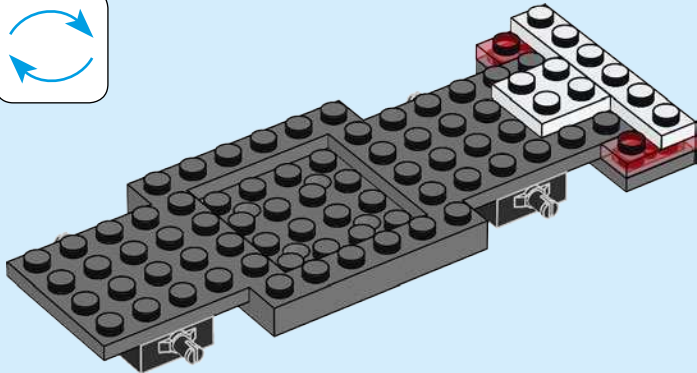
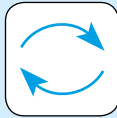

7

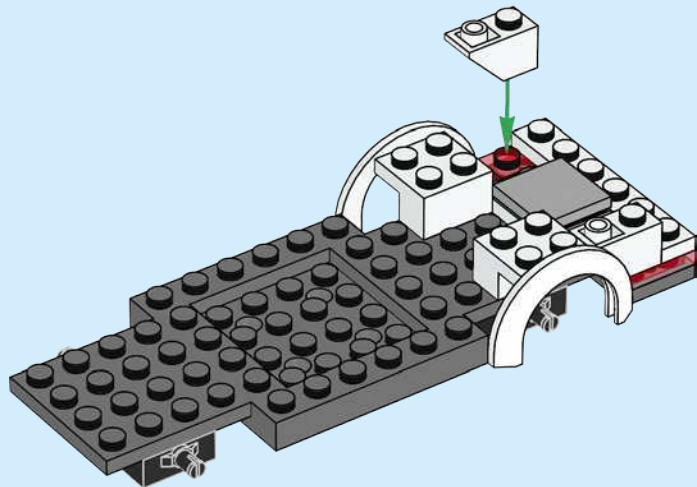

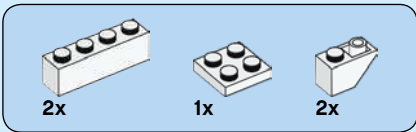

8

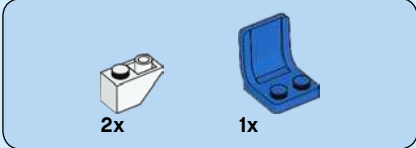
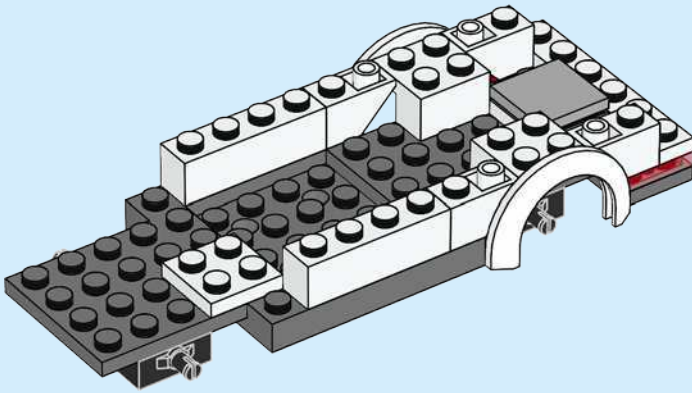

9

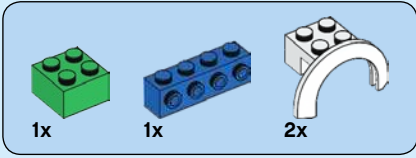
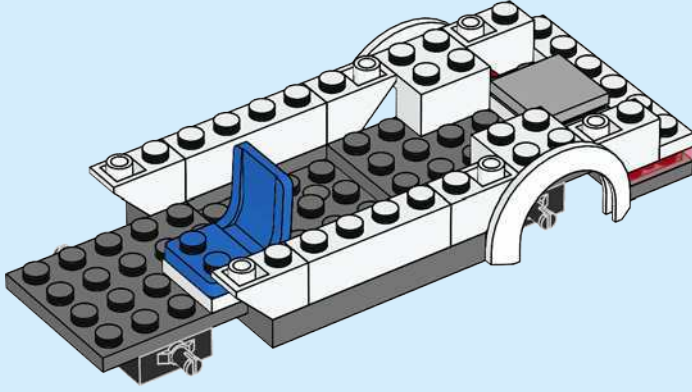

10

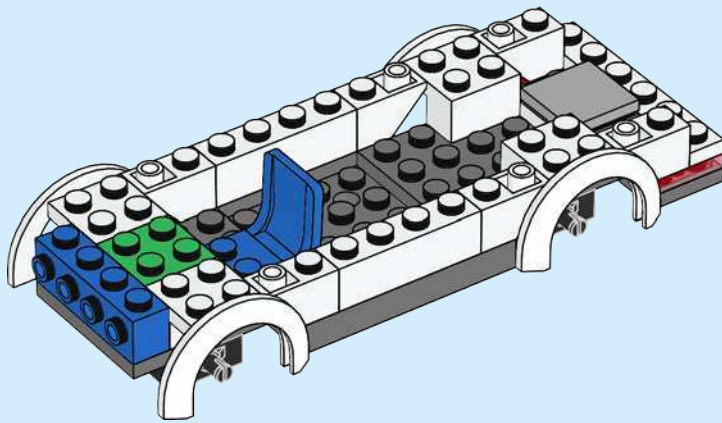

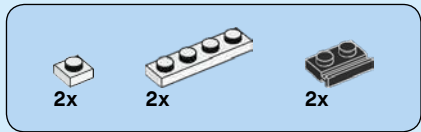

11

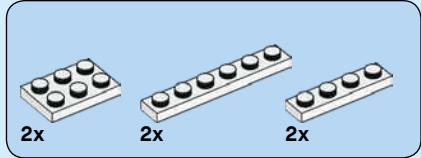
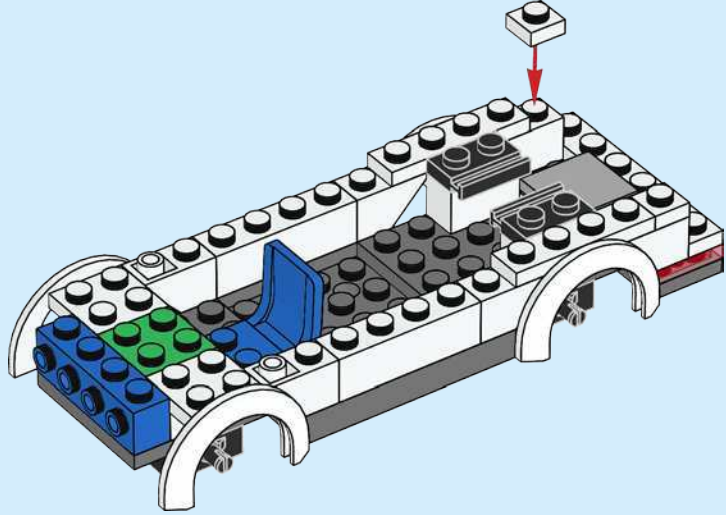

12

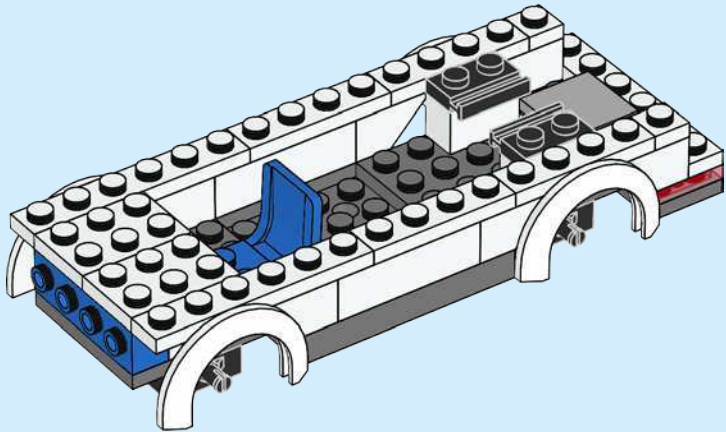

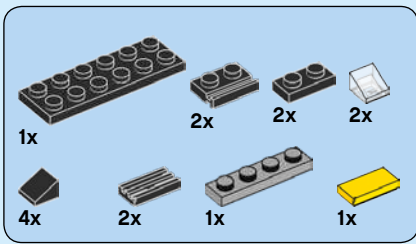

13

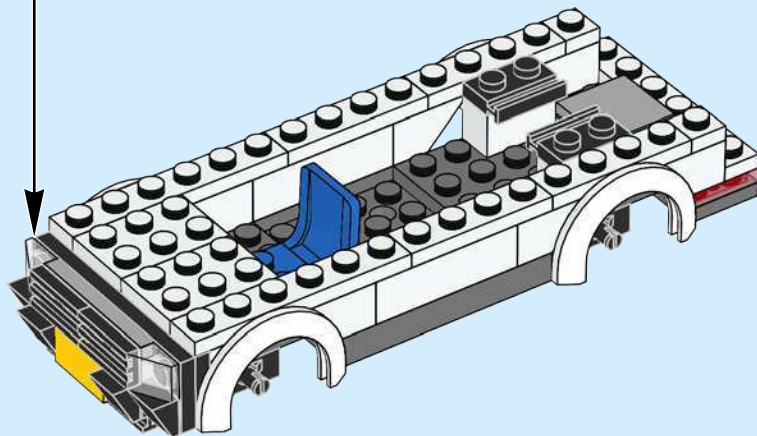
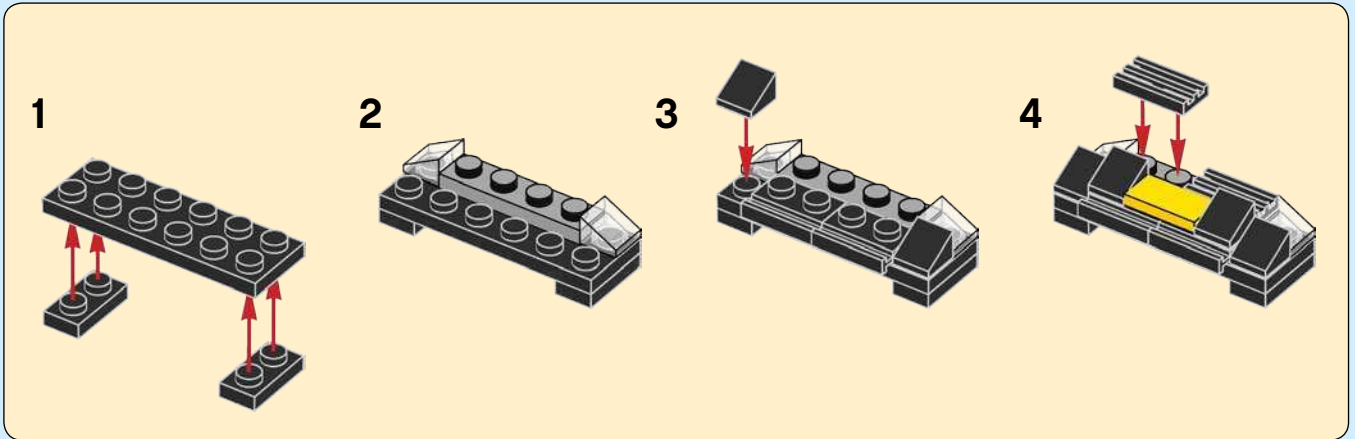

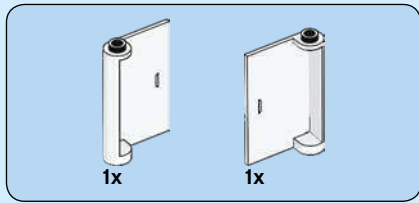

14

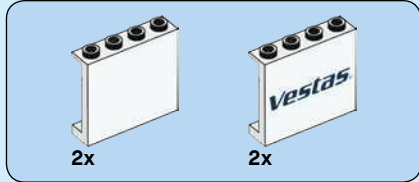
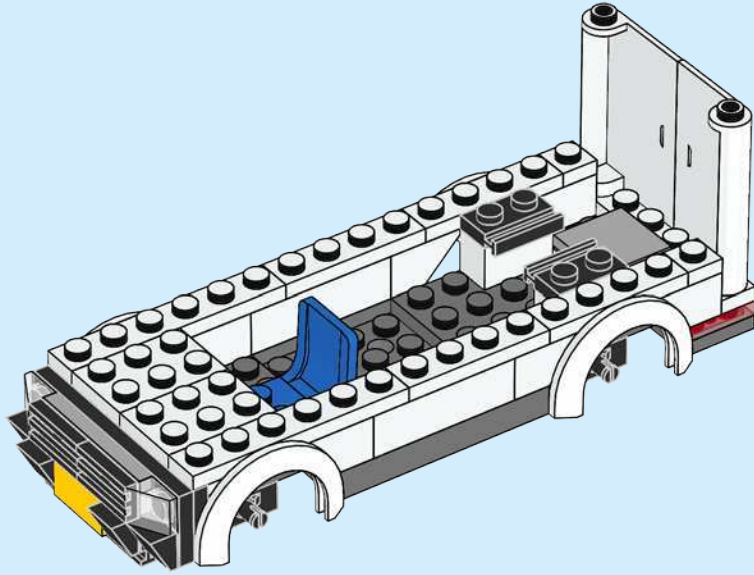

15

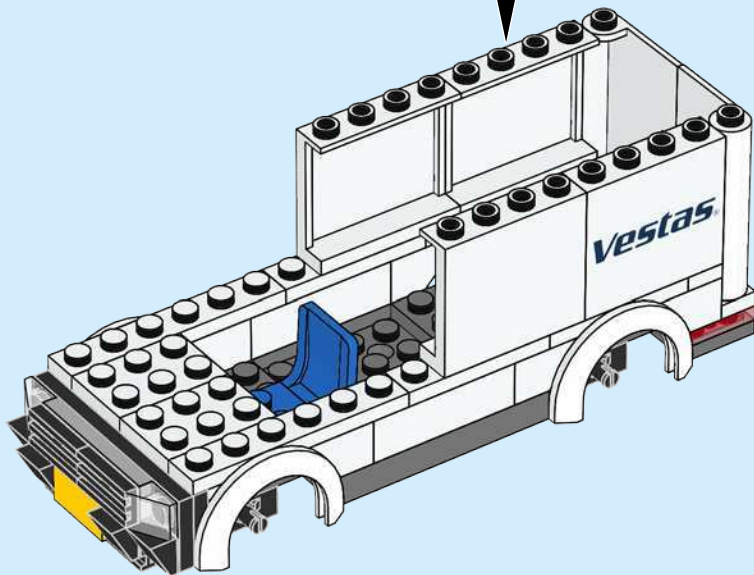

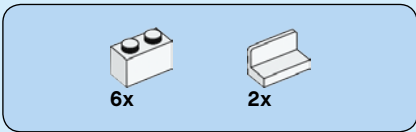

16

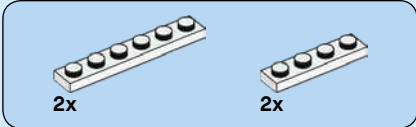
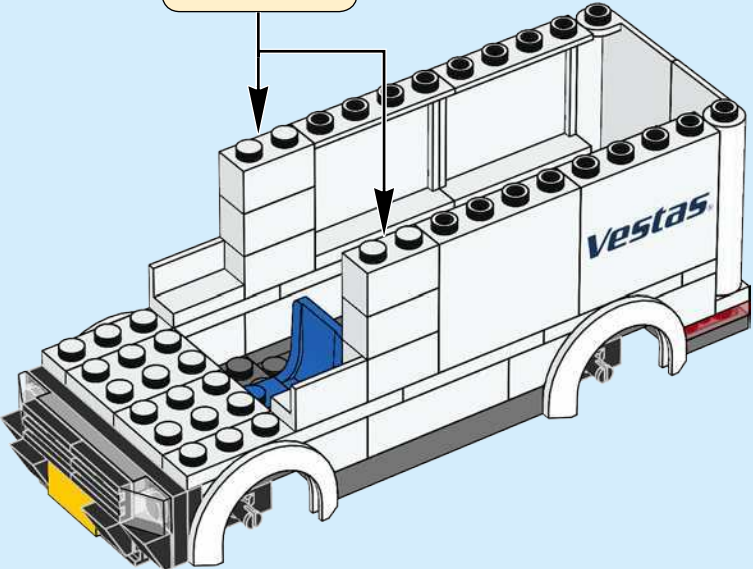
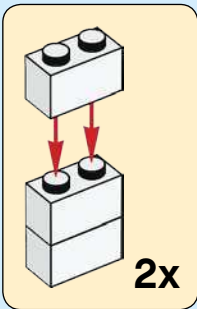

17

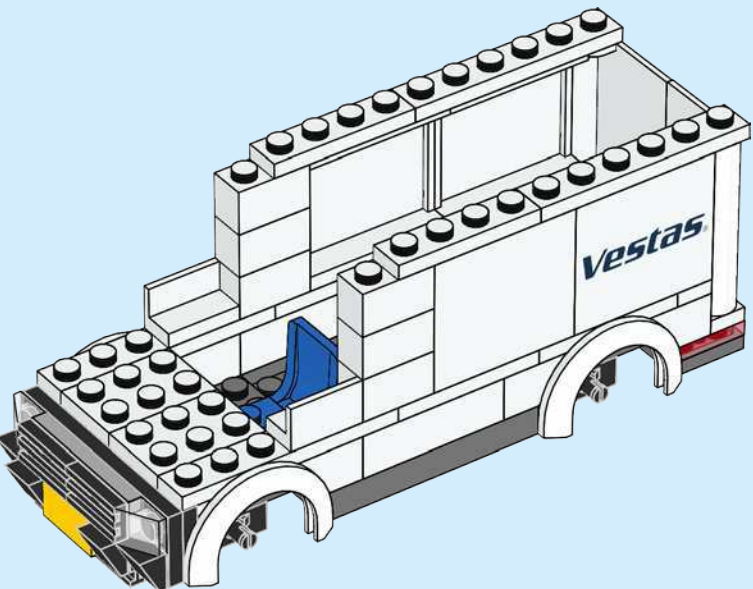

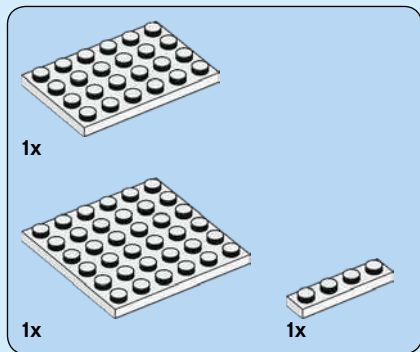

18

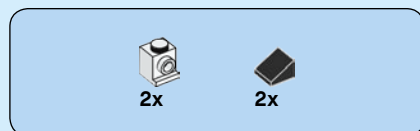
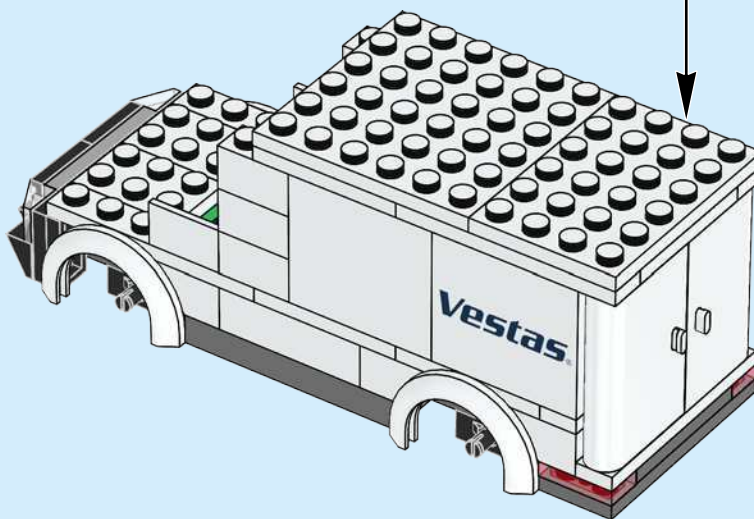
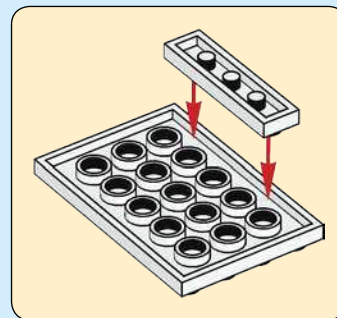

19

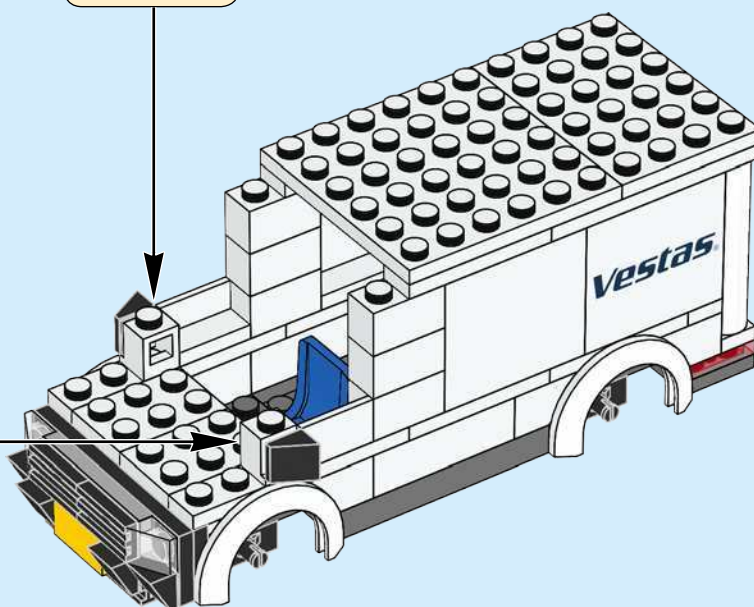
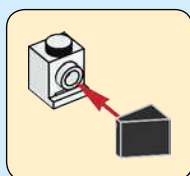
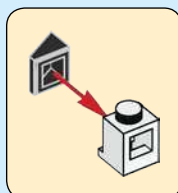

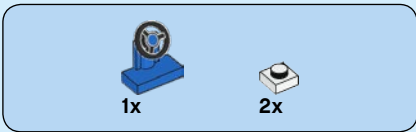

20

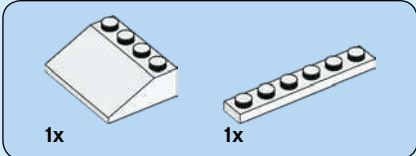
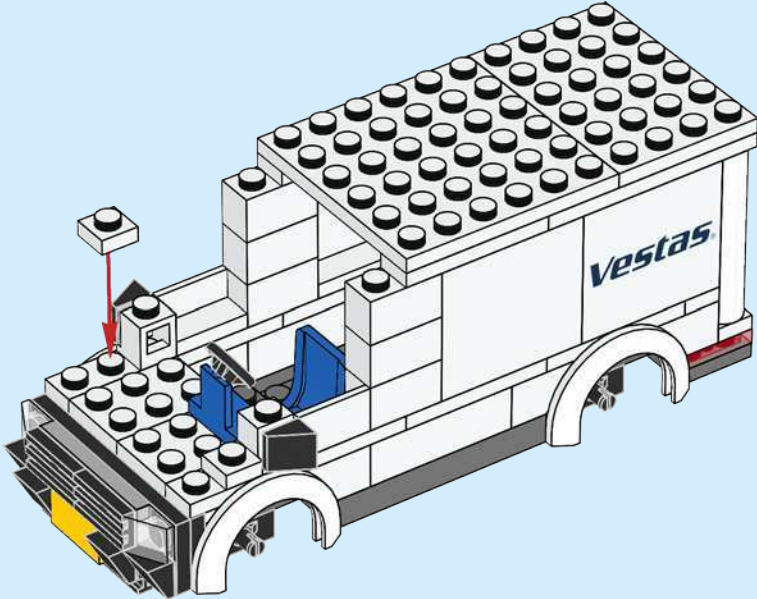

21

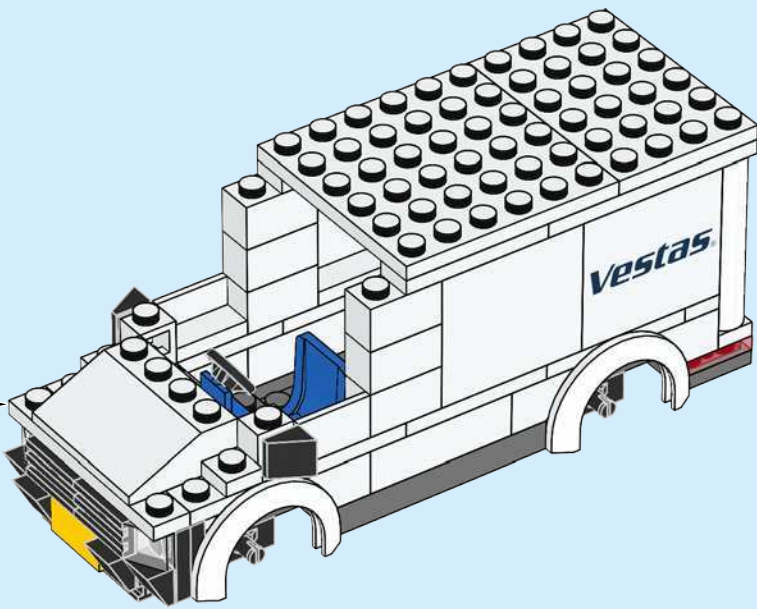
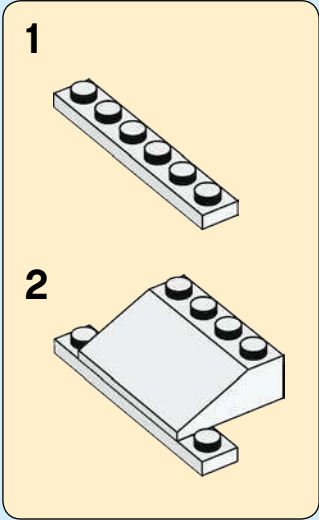



2x

22

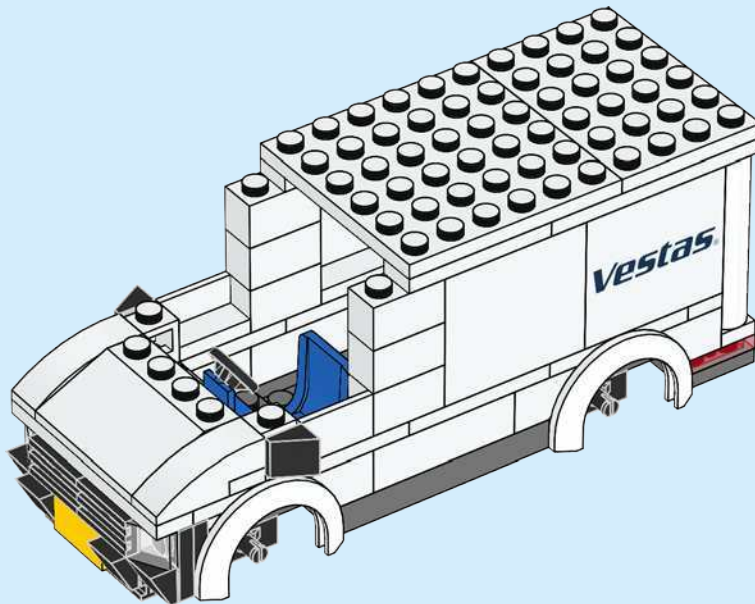

1x

23

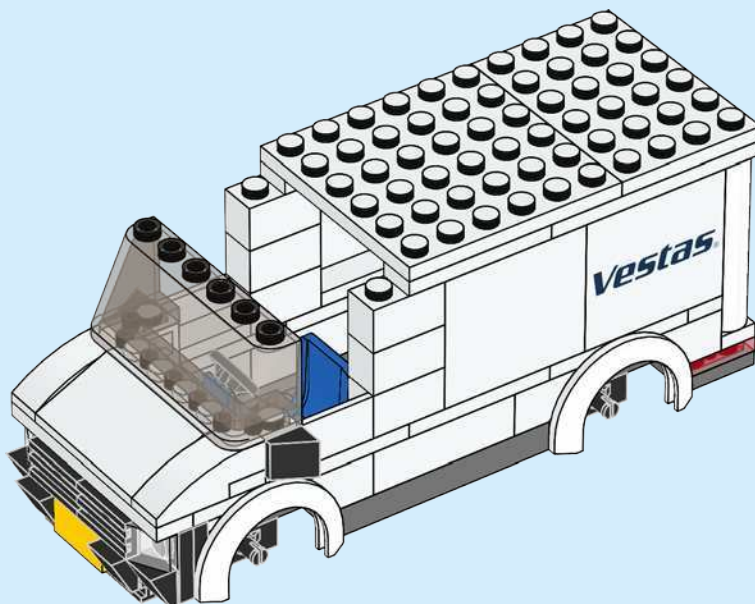

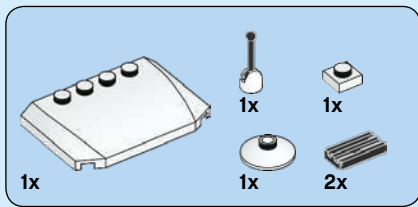

24

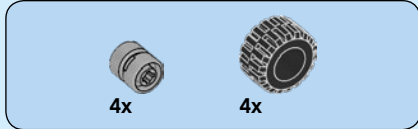
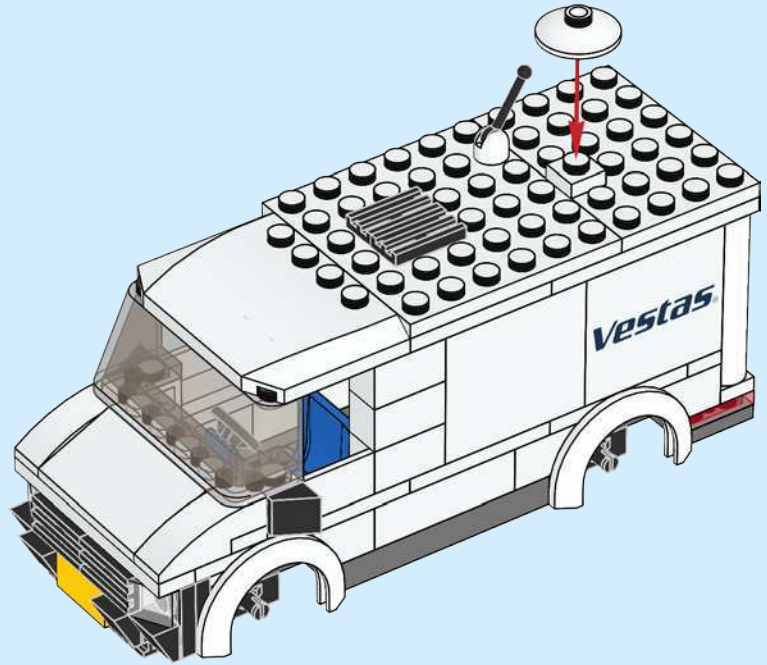

25

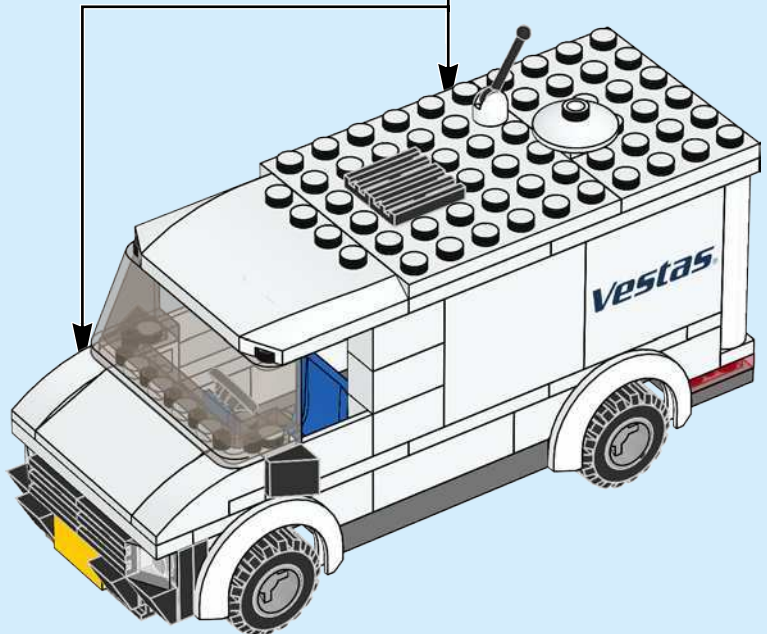
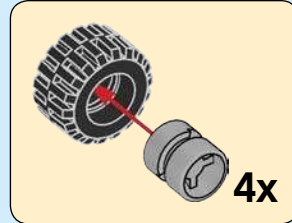

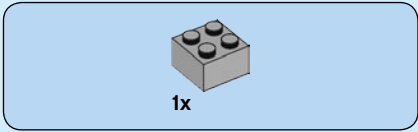
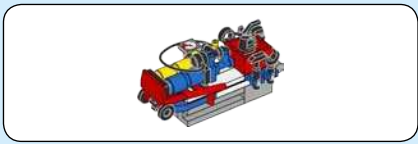

26

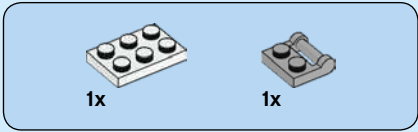
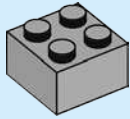

27

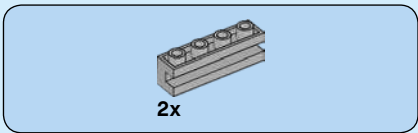
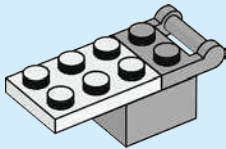

28

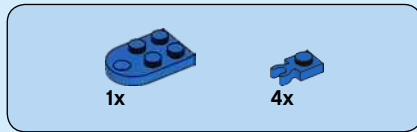
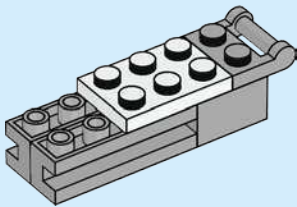

29

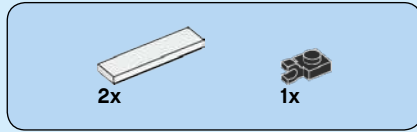
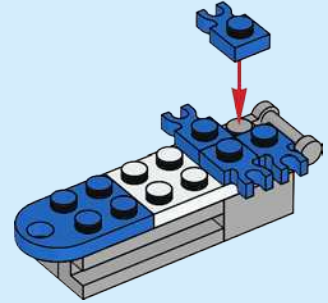

30

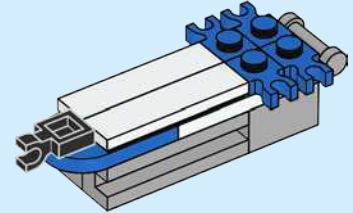

31

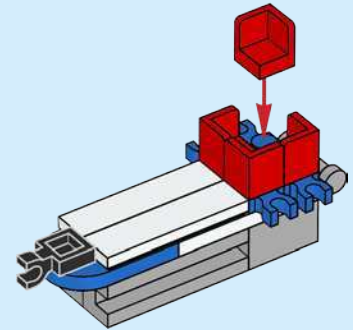

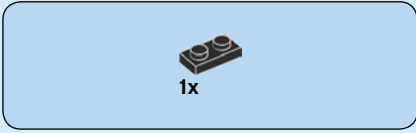

32

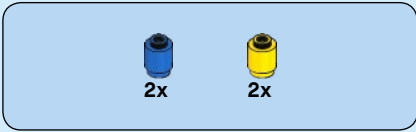

33

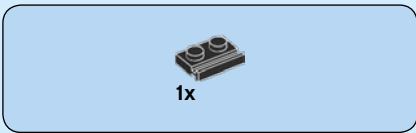
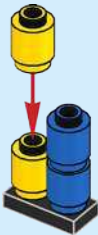

34



35

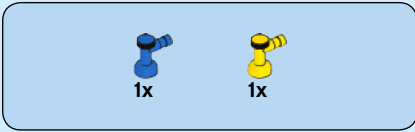
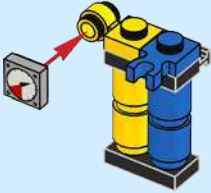

36

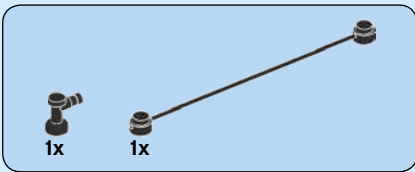

37

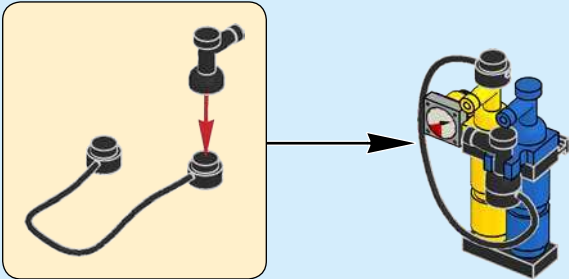

A Vestas wind power plant can be up and running in less than 12 months, defying the longer lead times involved with conventional fuels.

41

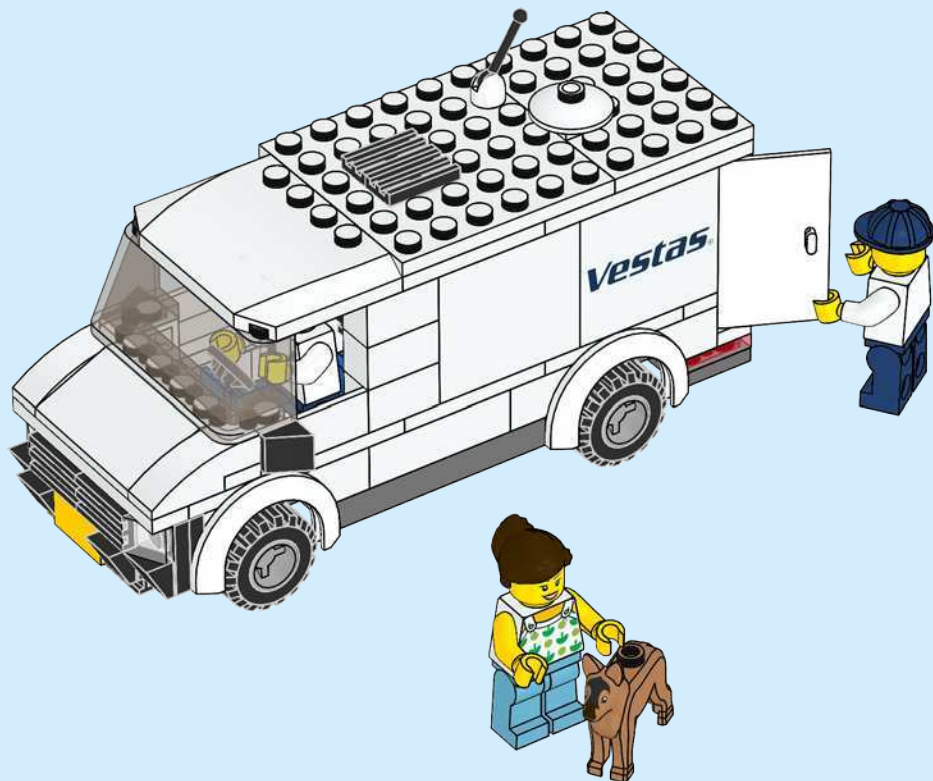
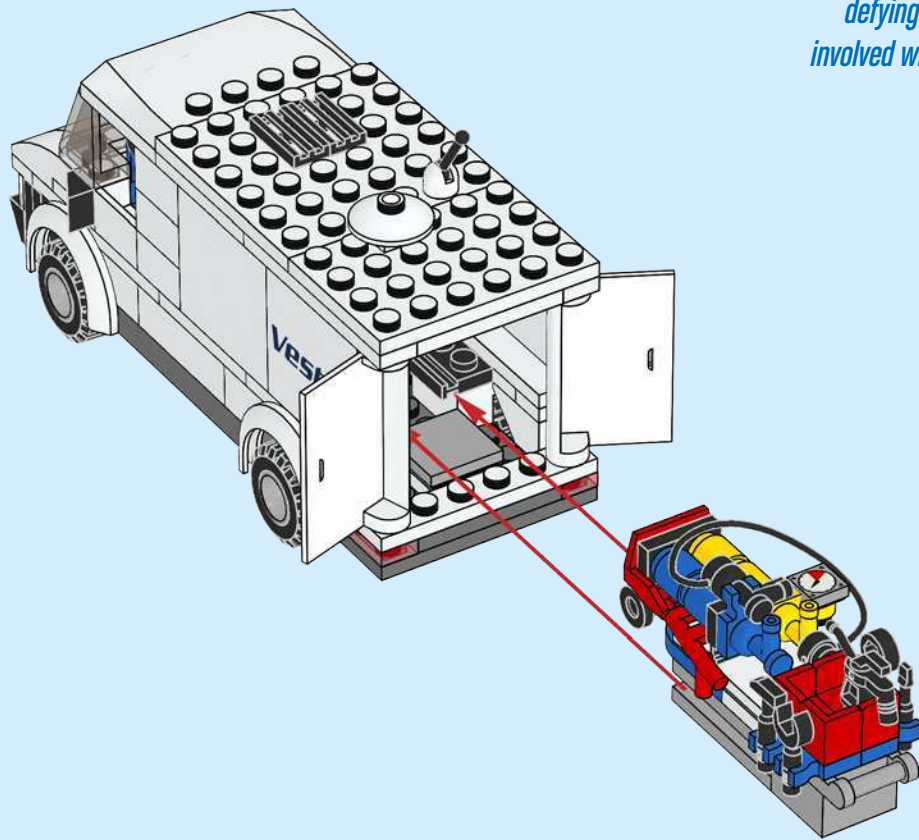

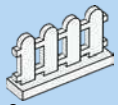

6x

1

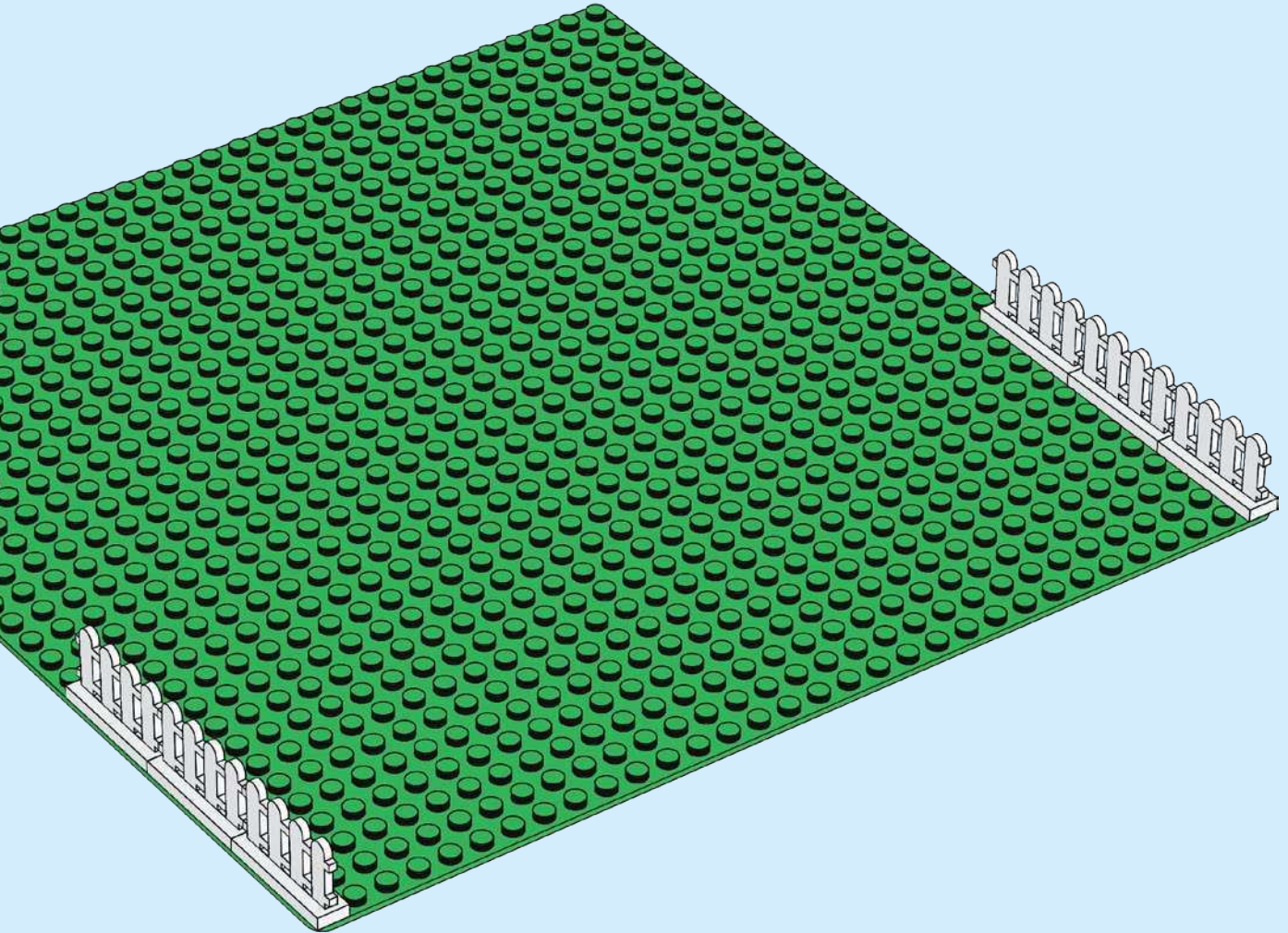

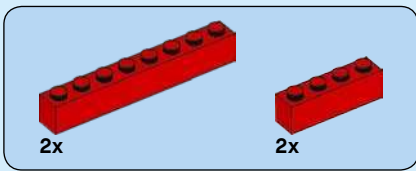

2

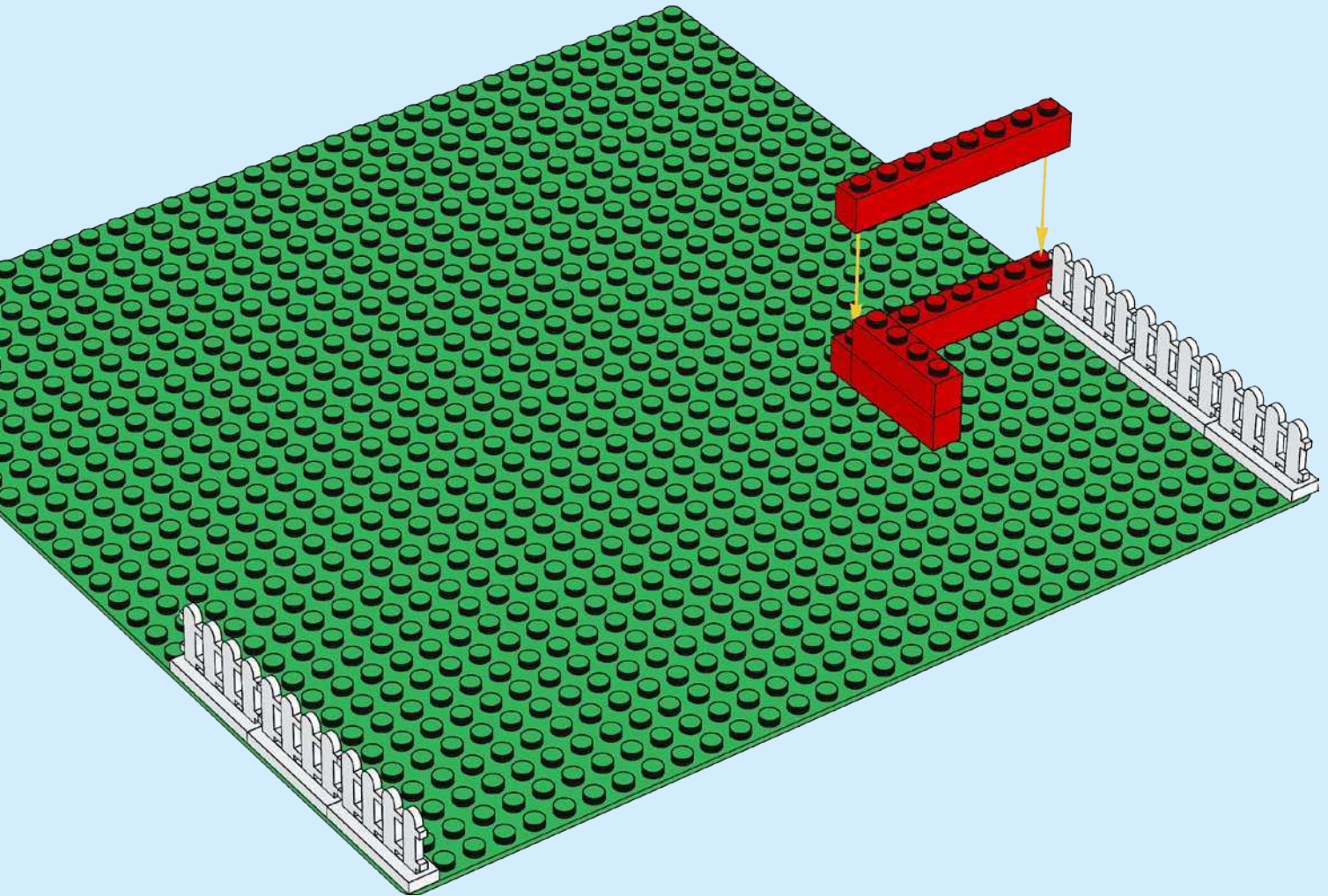

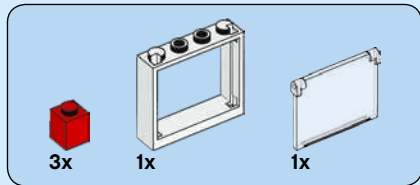

3

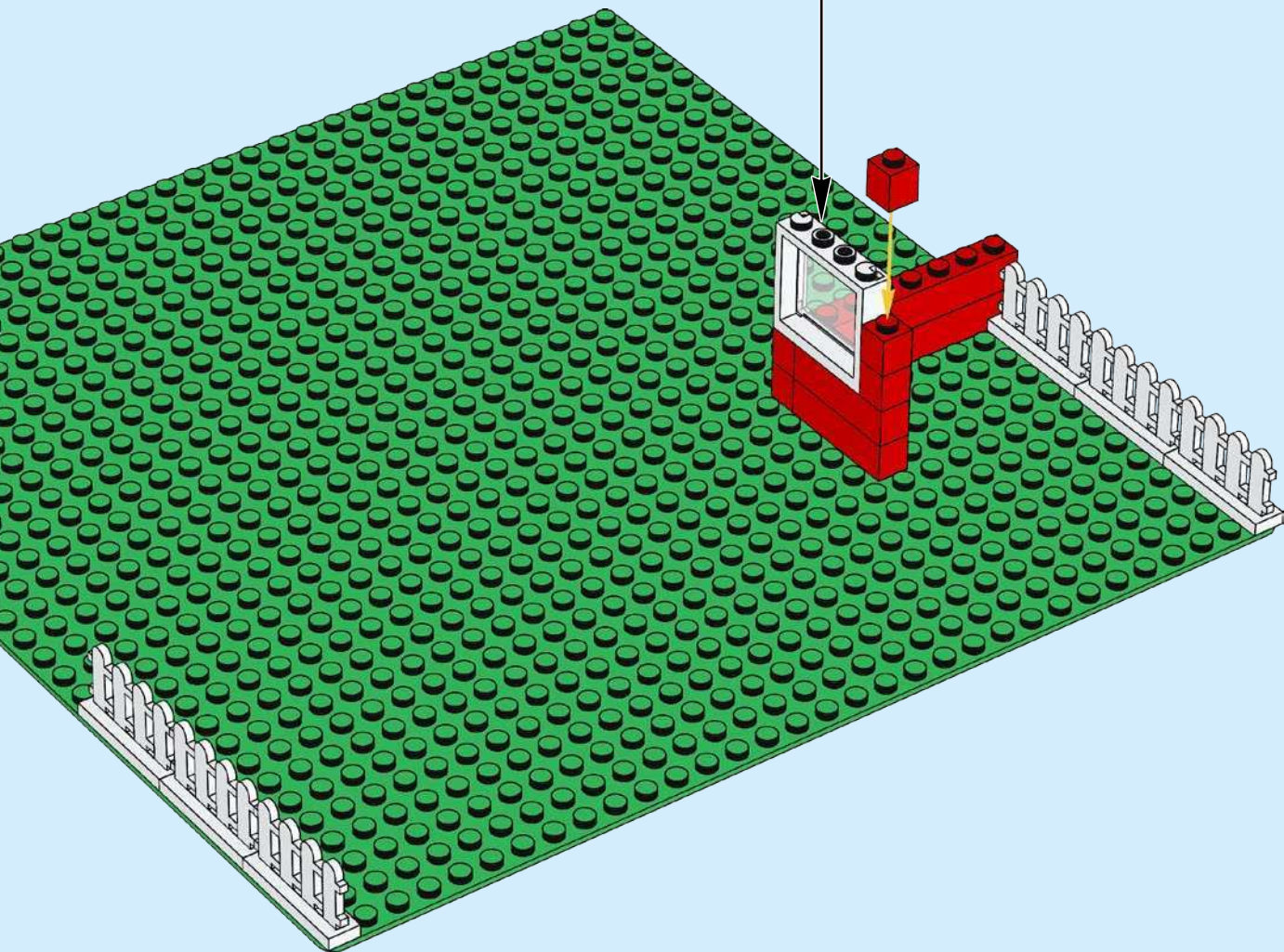
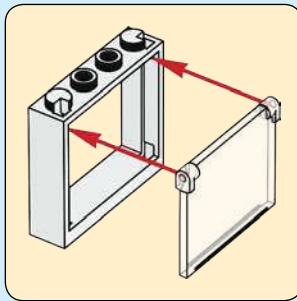

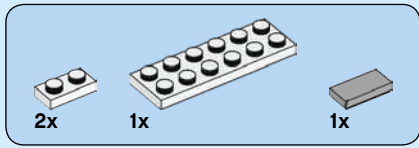

4

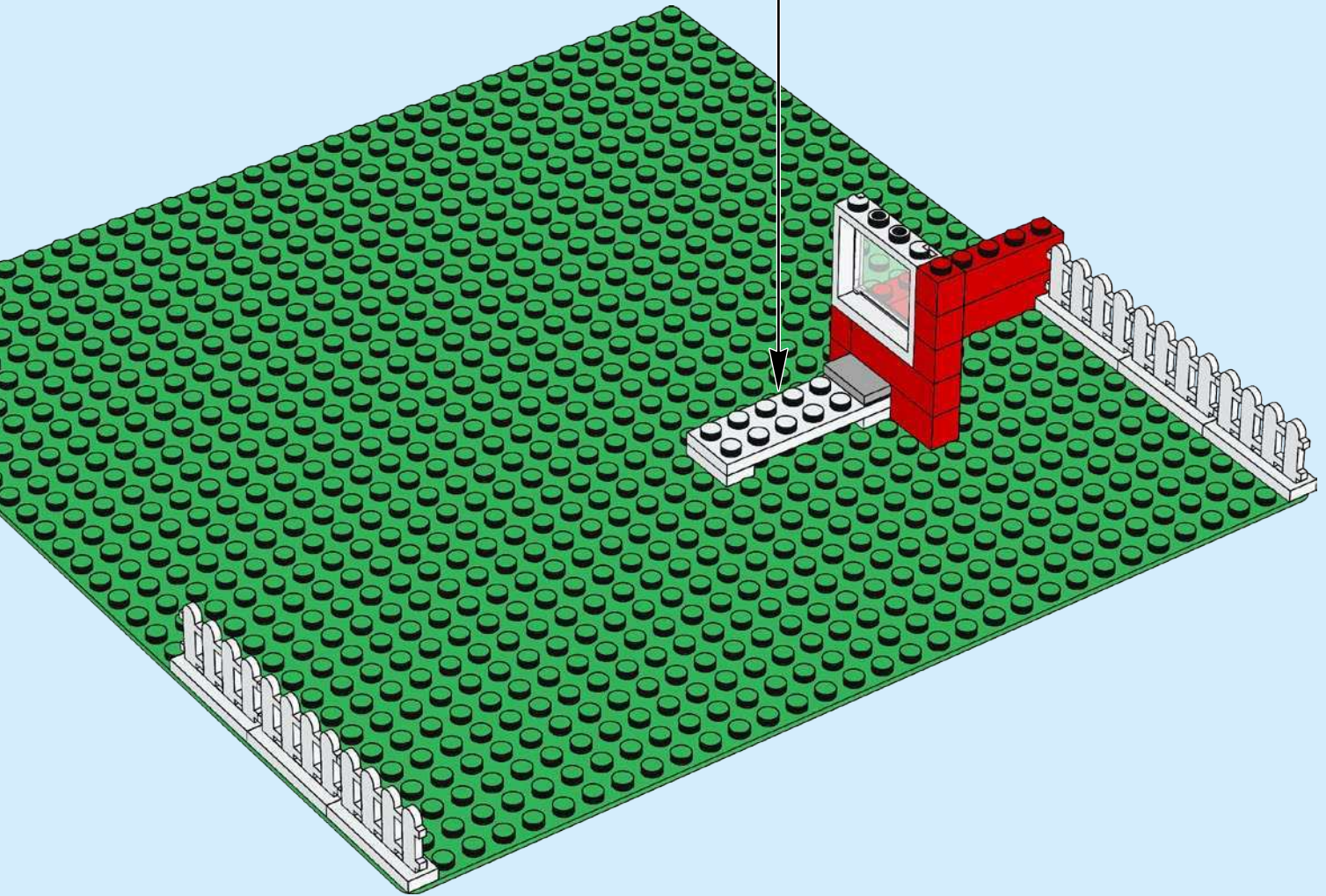
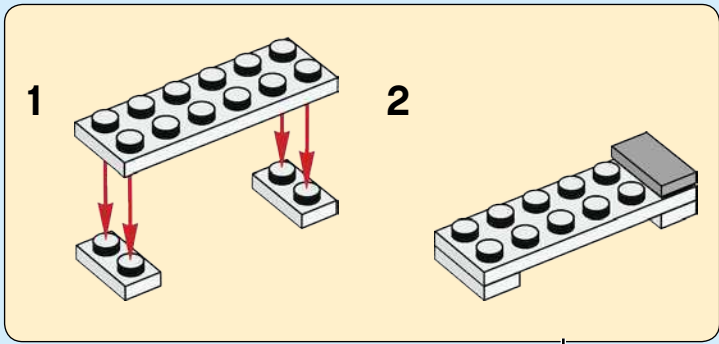

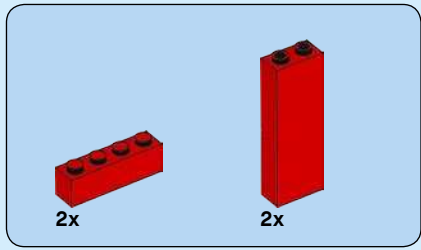

5

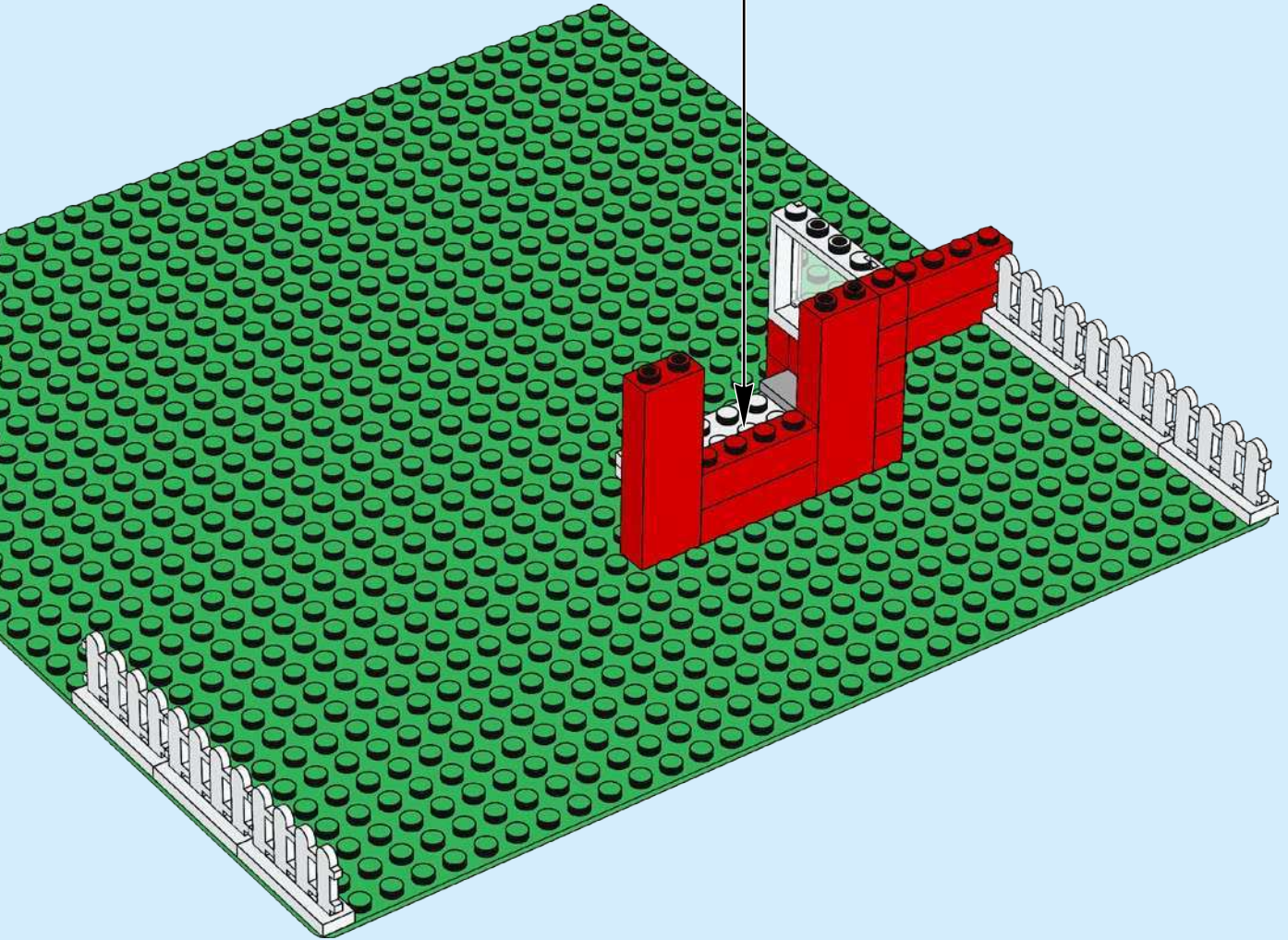
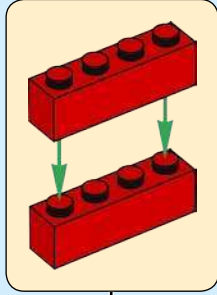

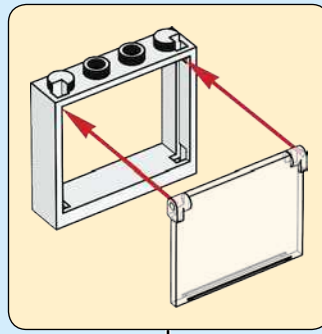
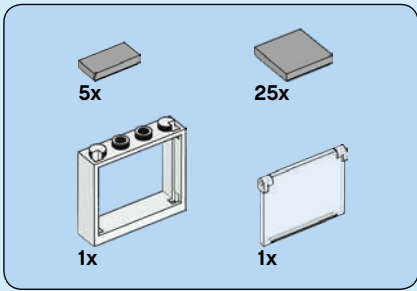

6

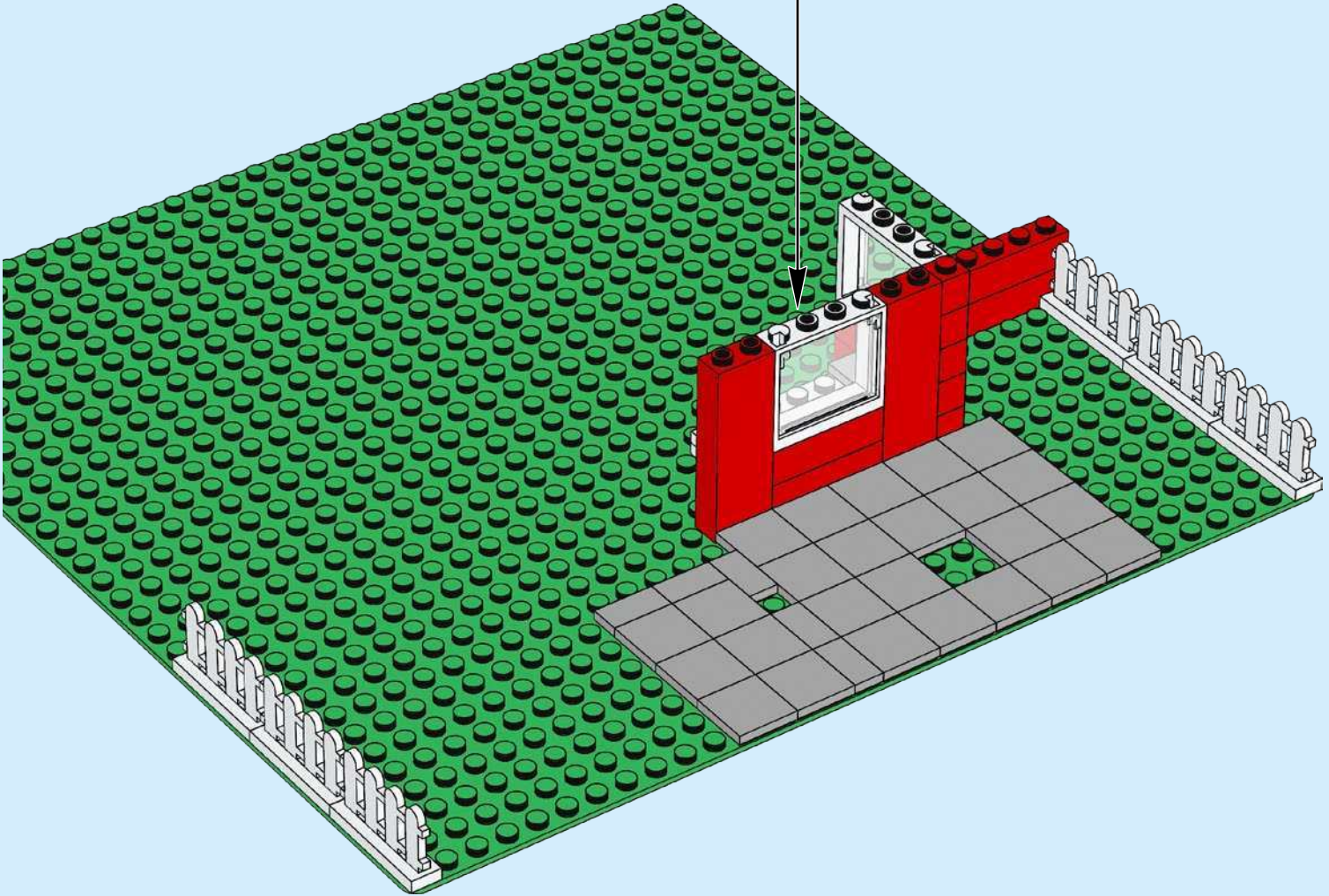

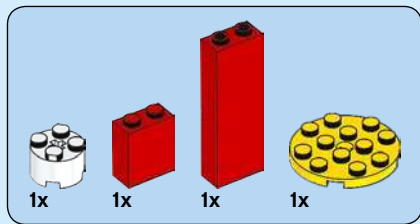

7

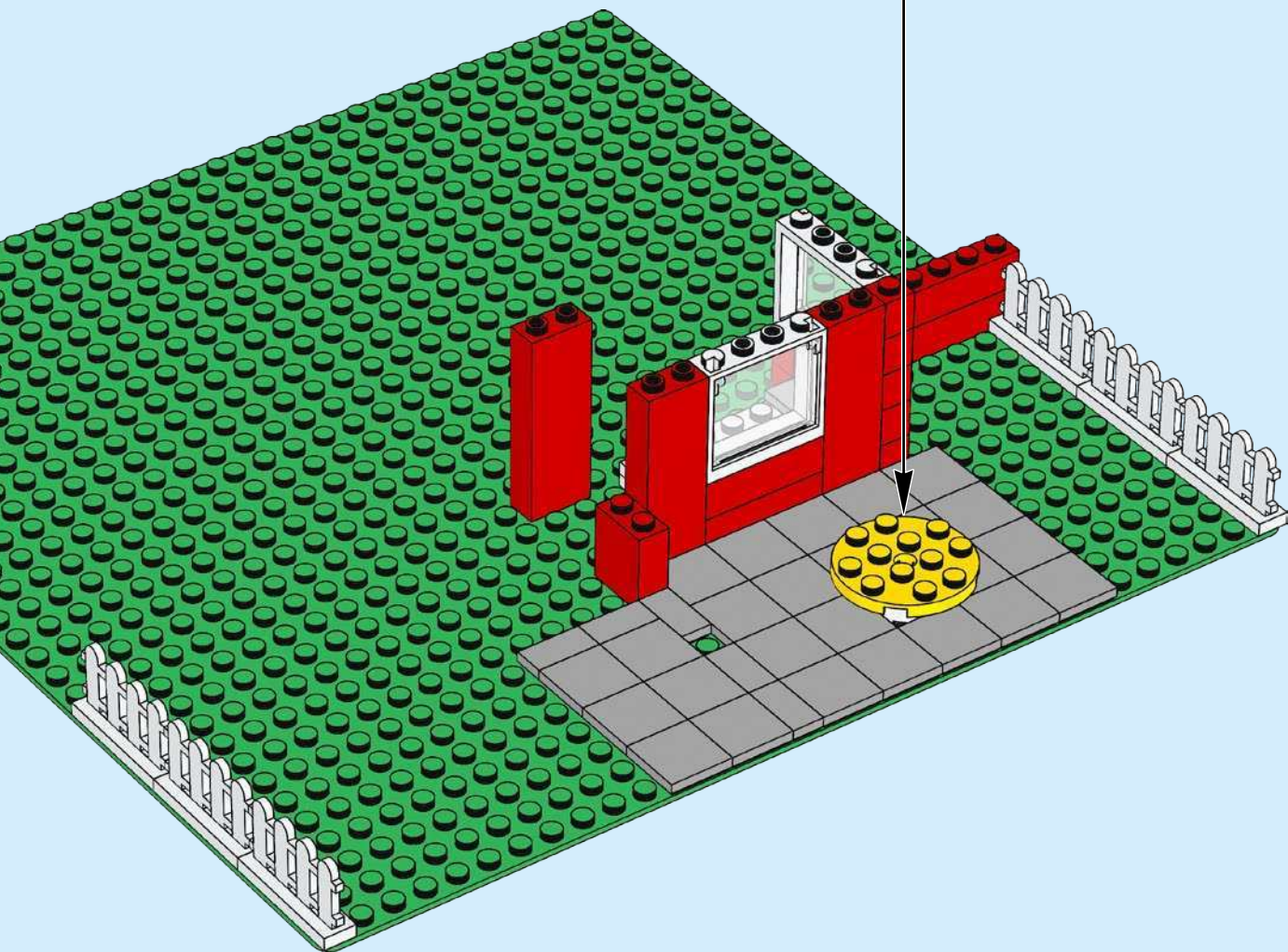

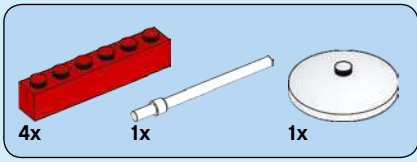

8

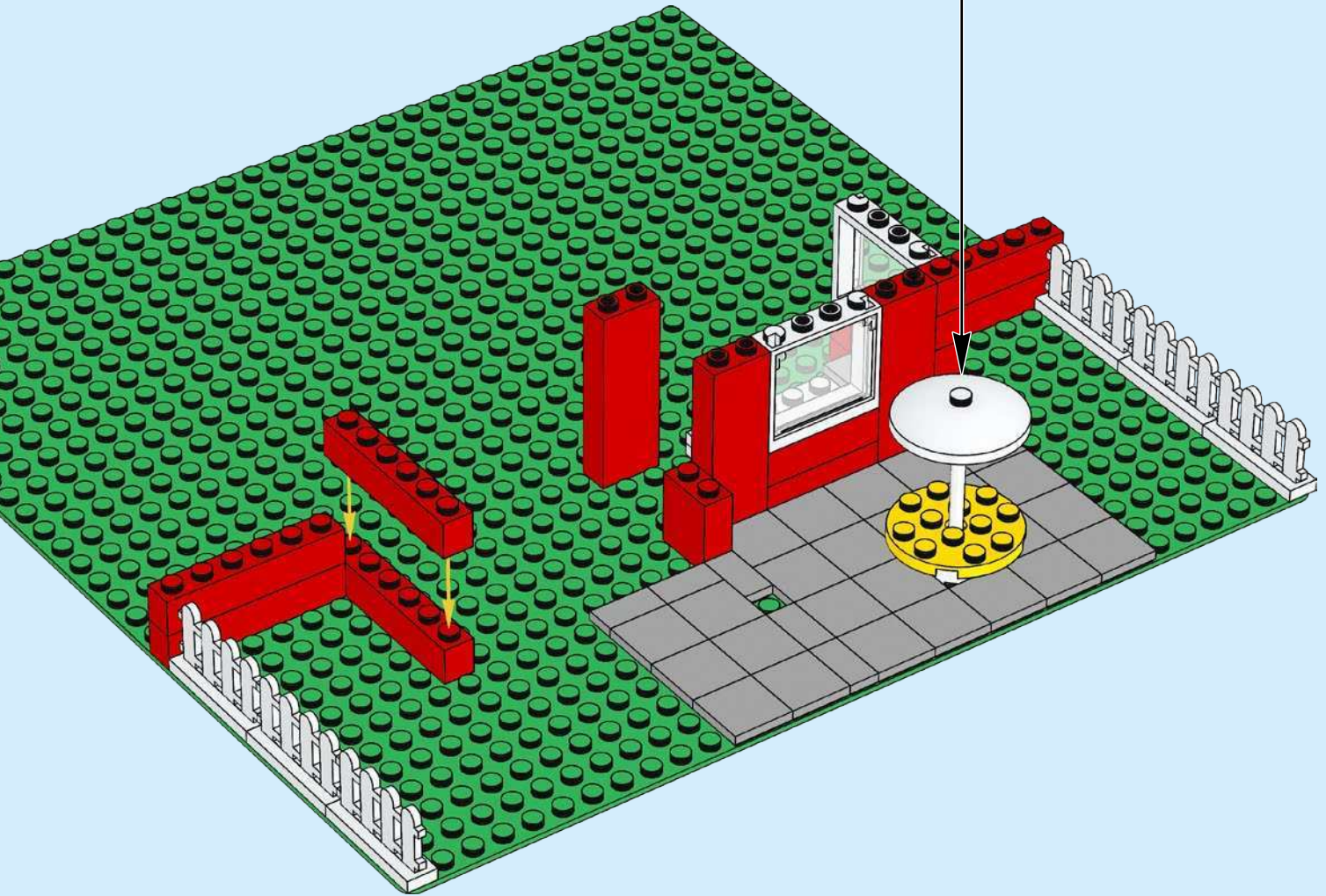
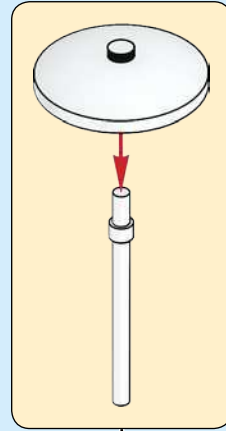

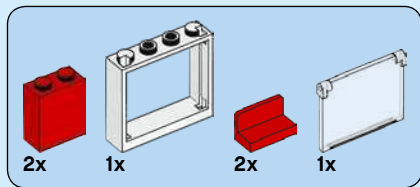

9

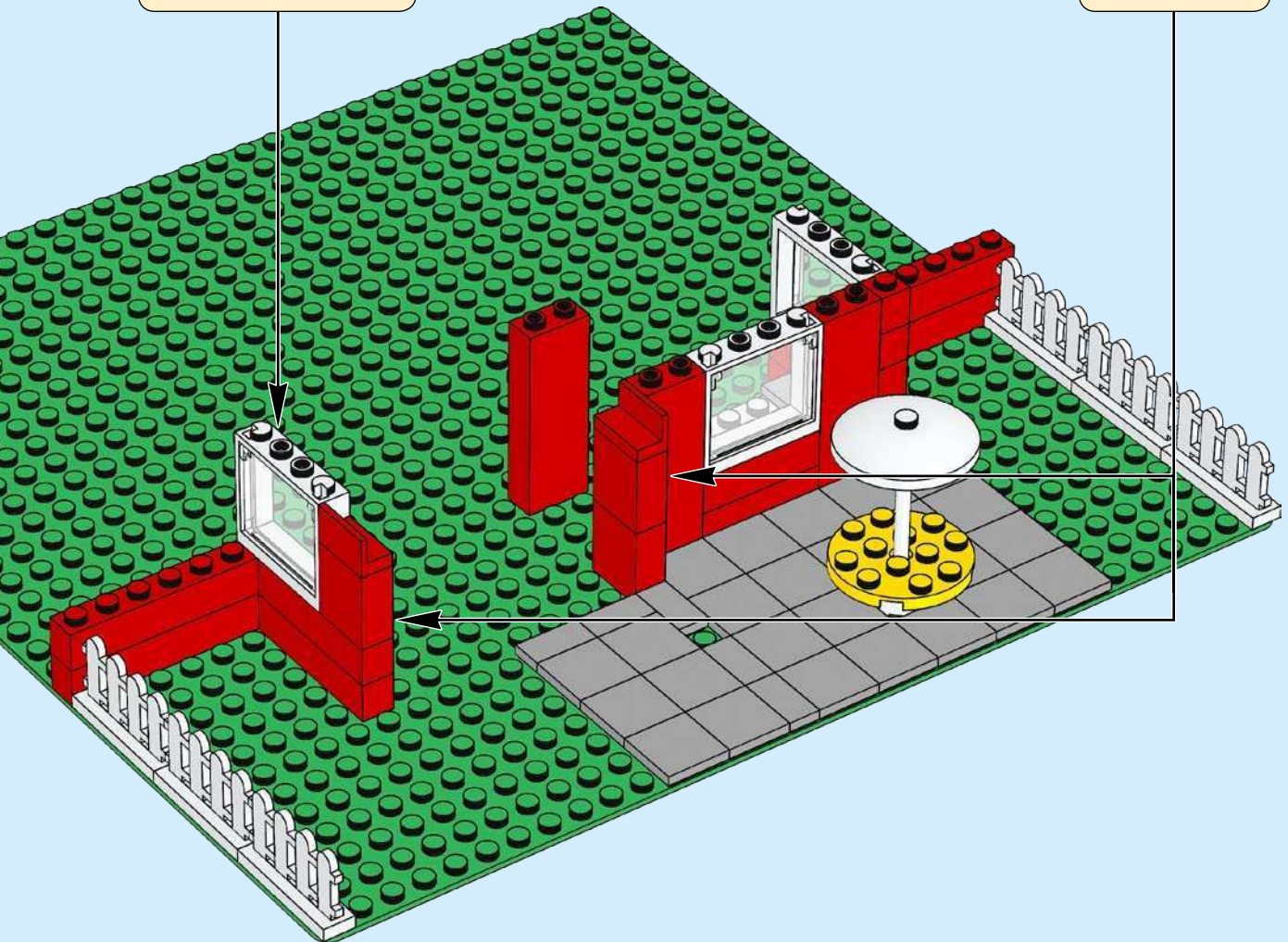
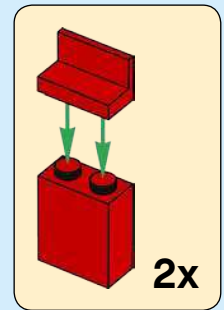
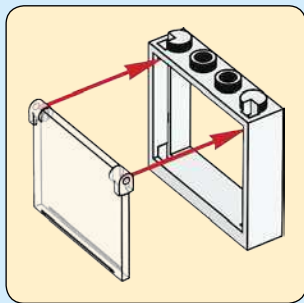

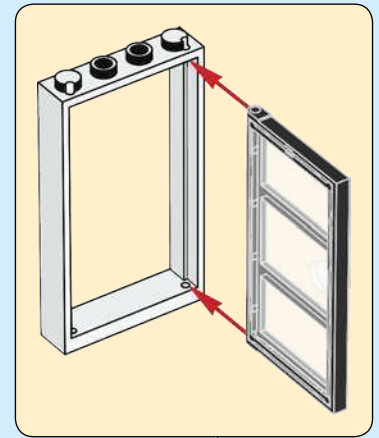
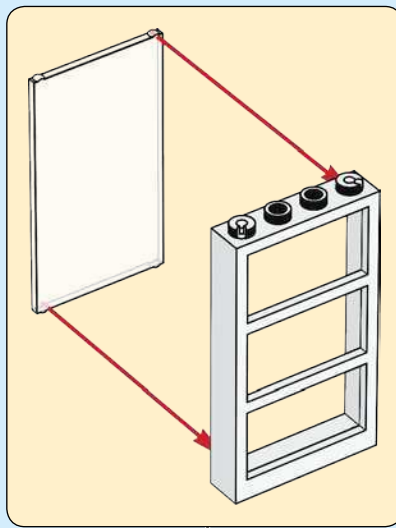
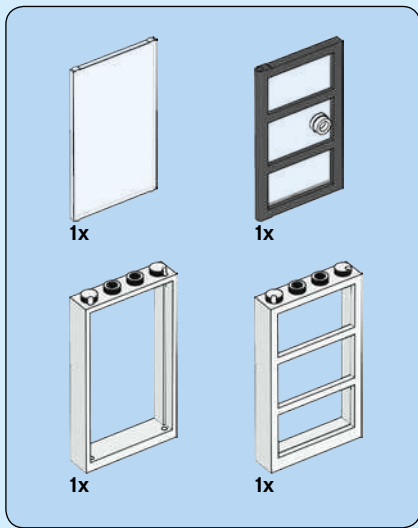

10

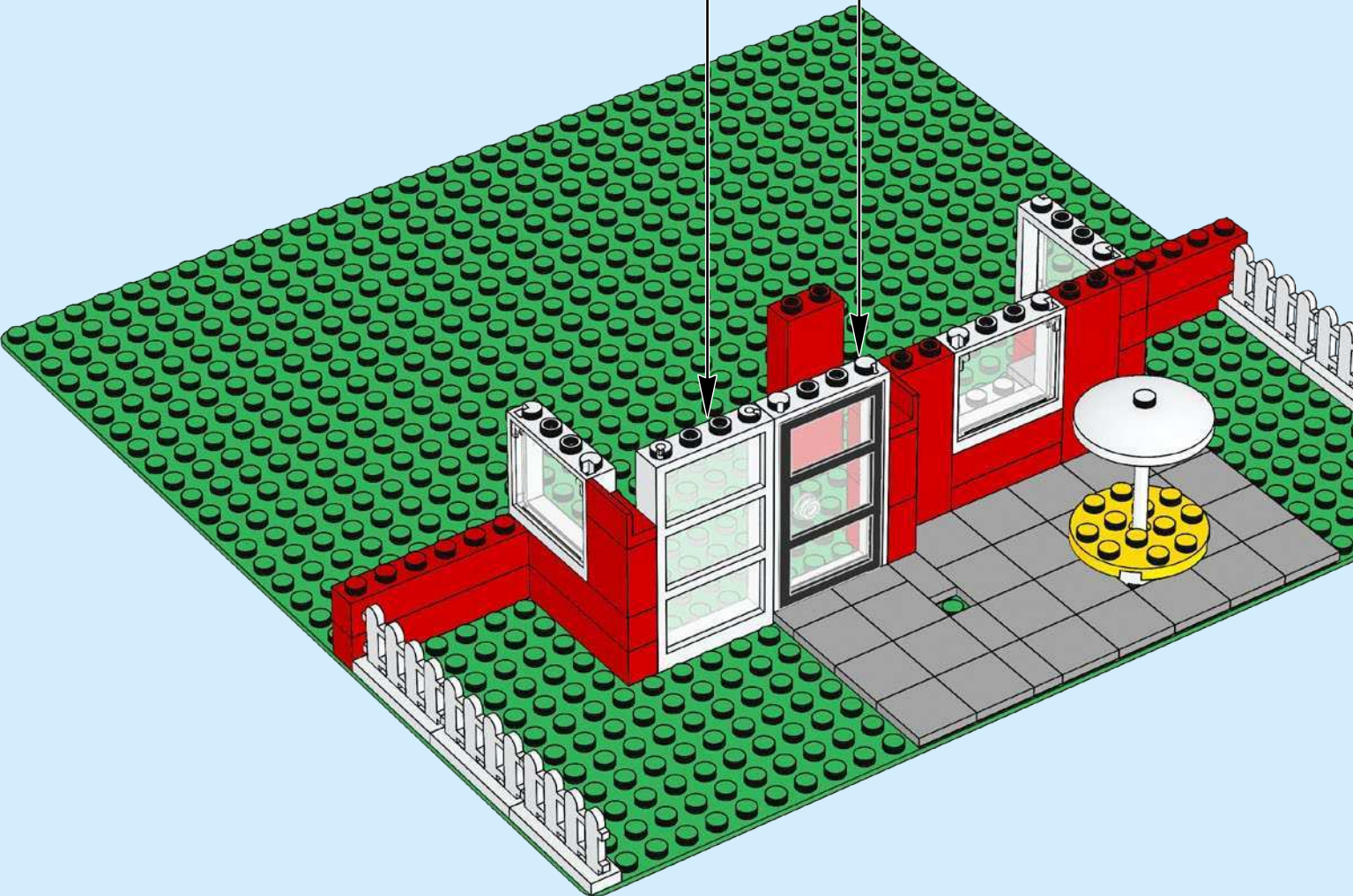



11

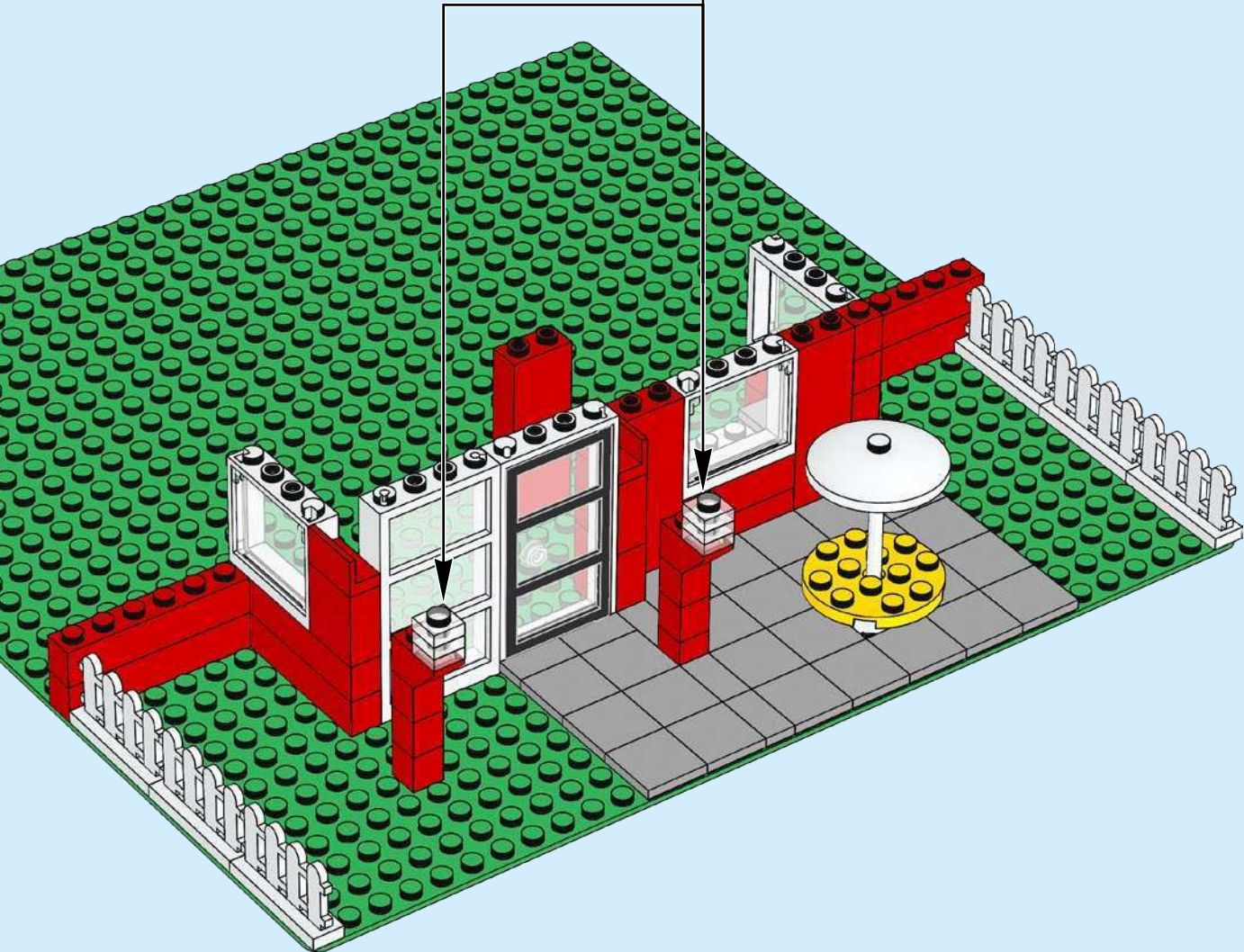
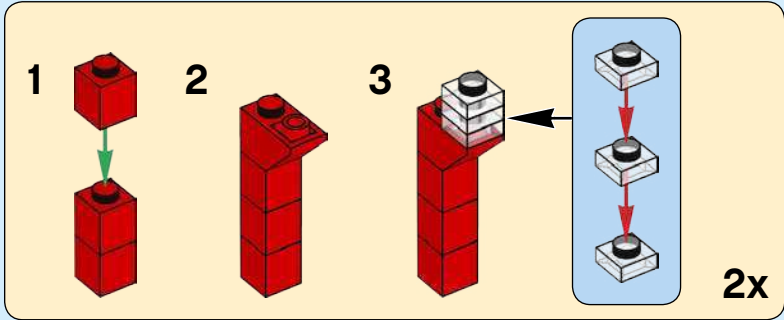

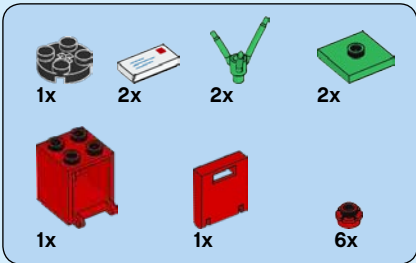

12

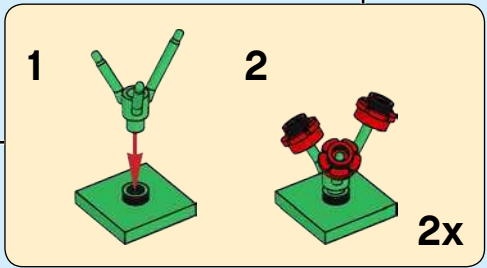
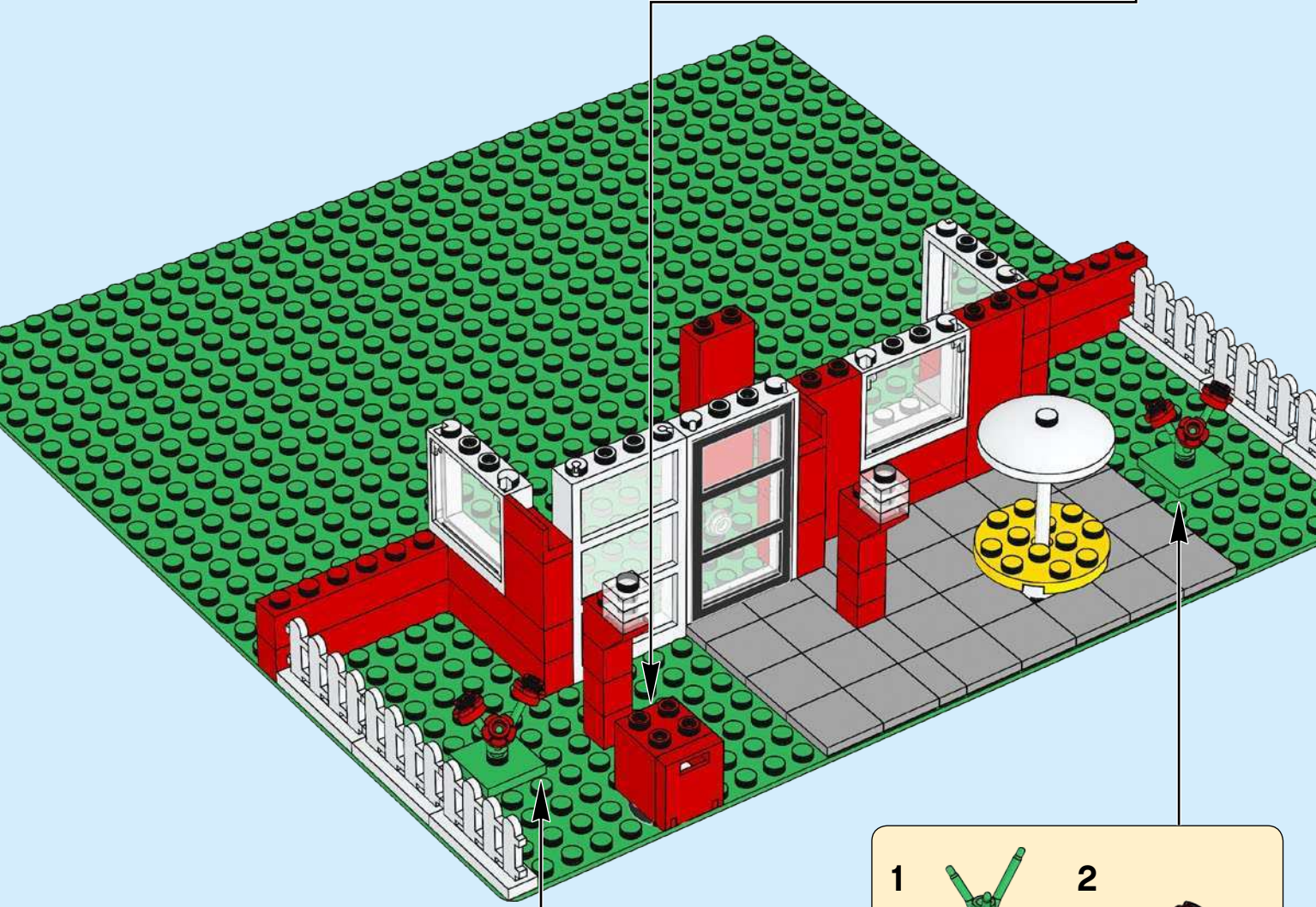
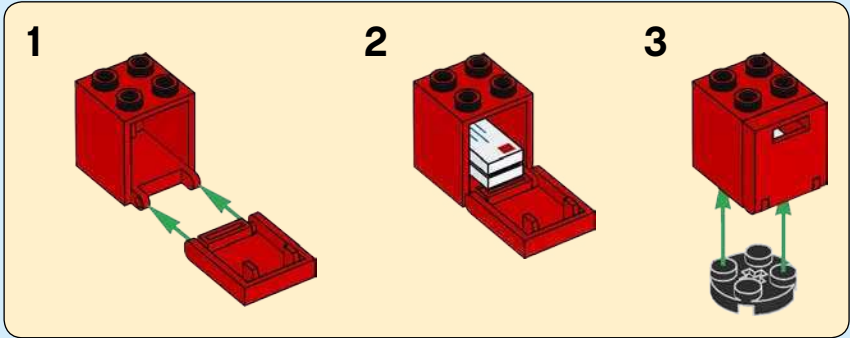

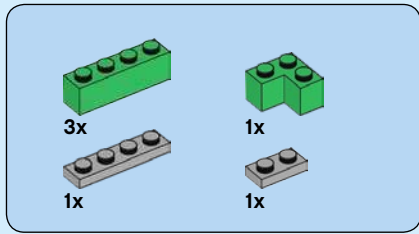

13

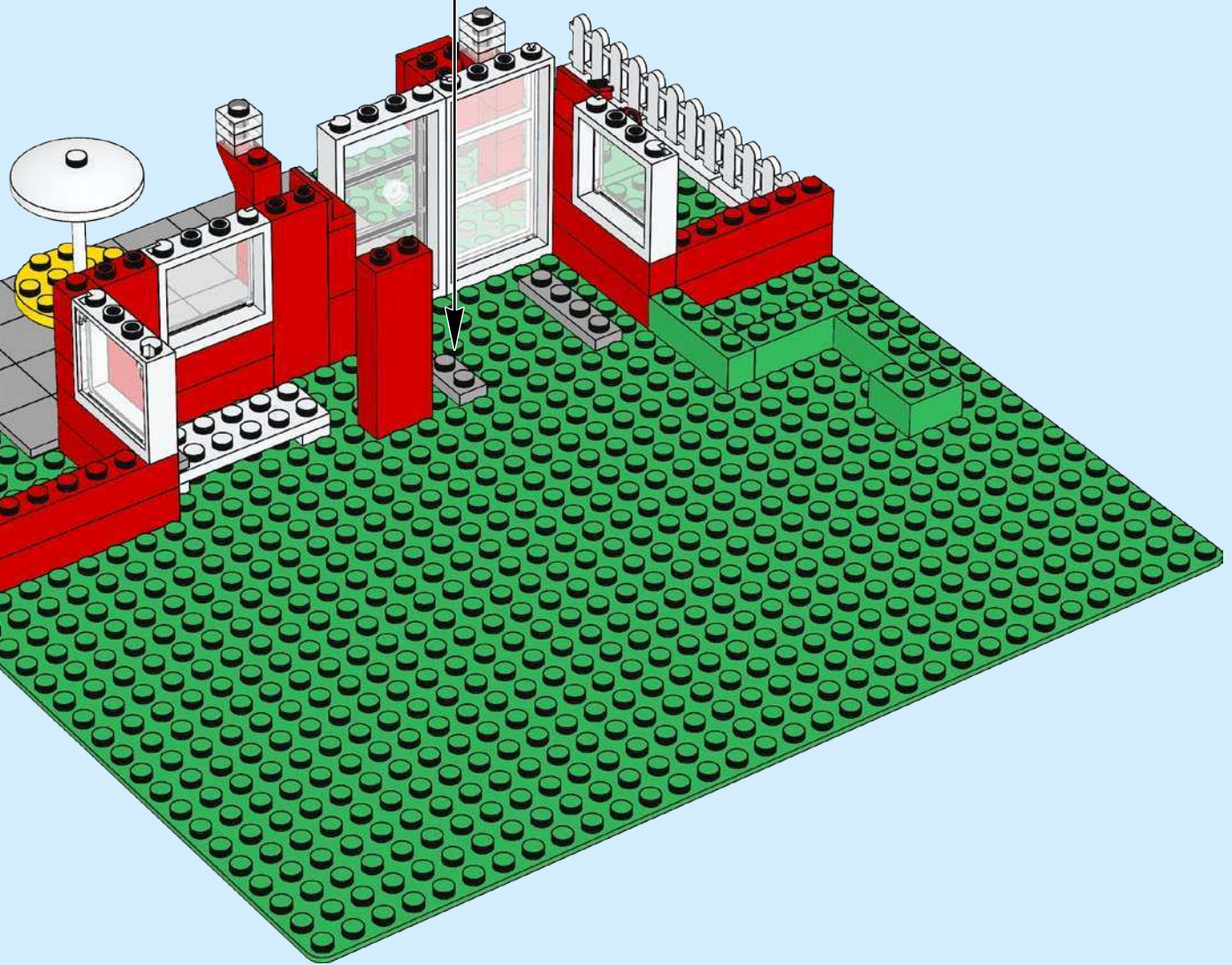
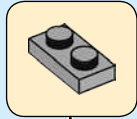
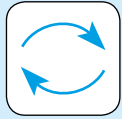

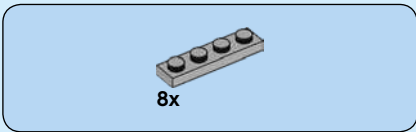

14

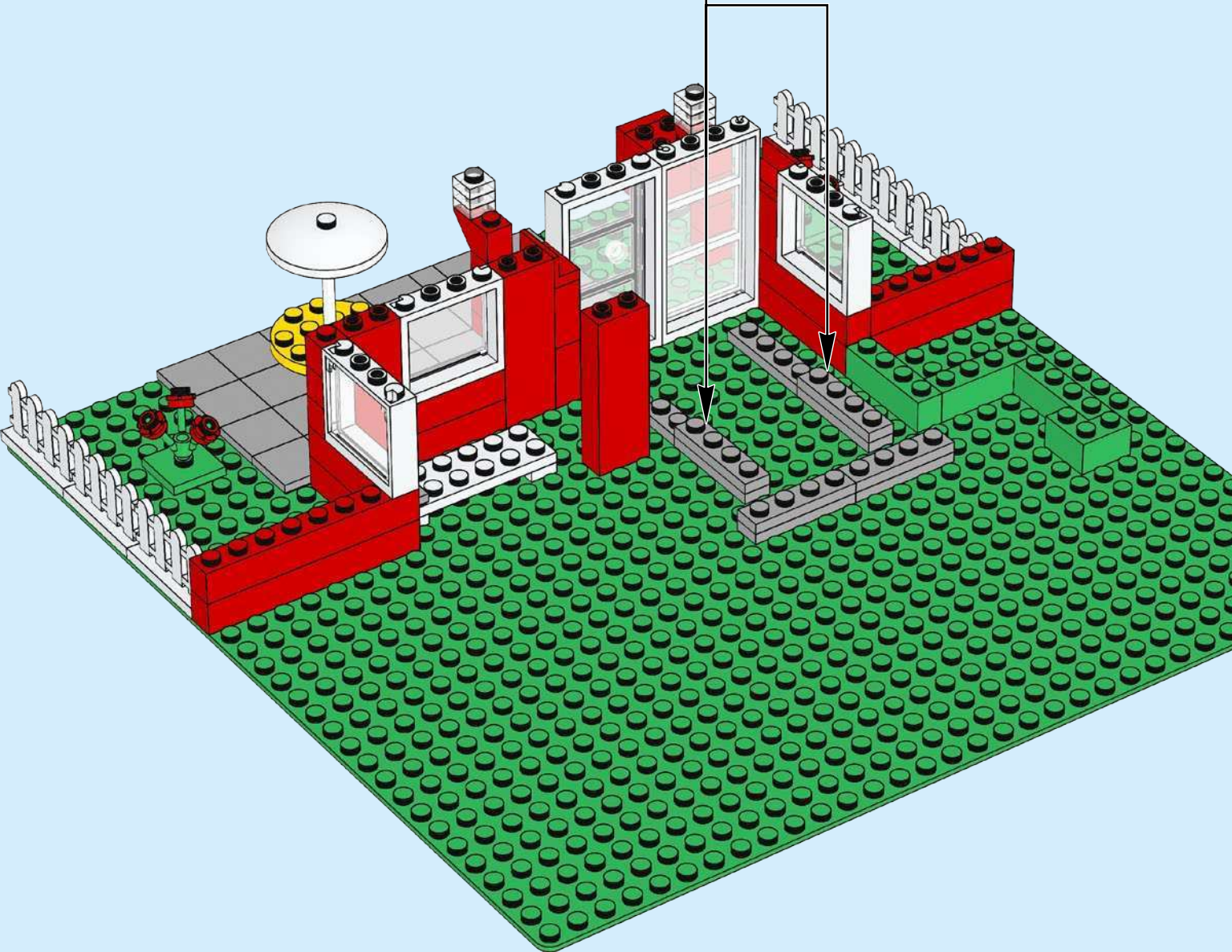
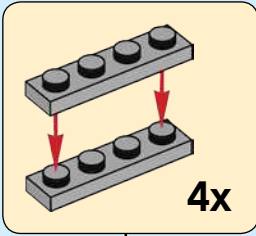

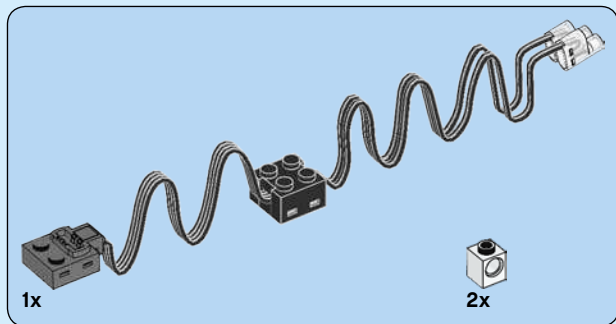

15

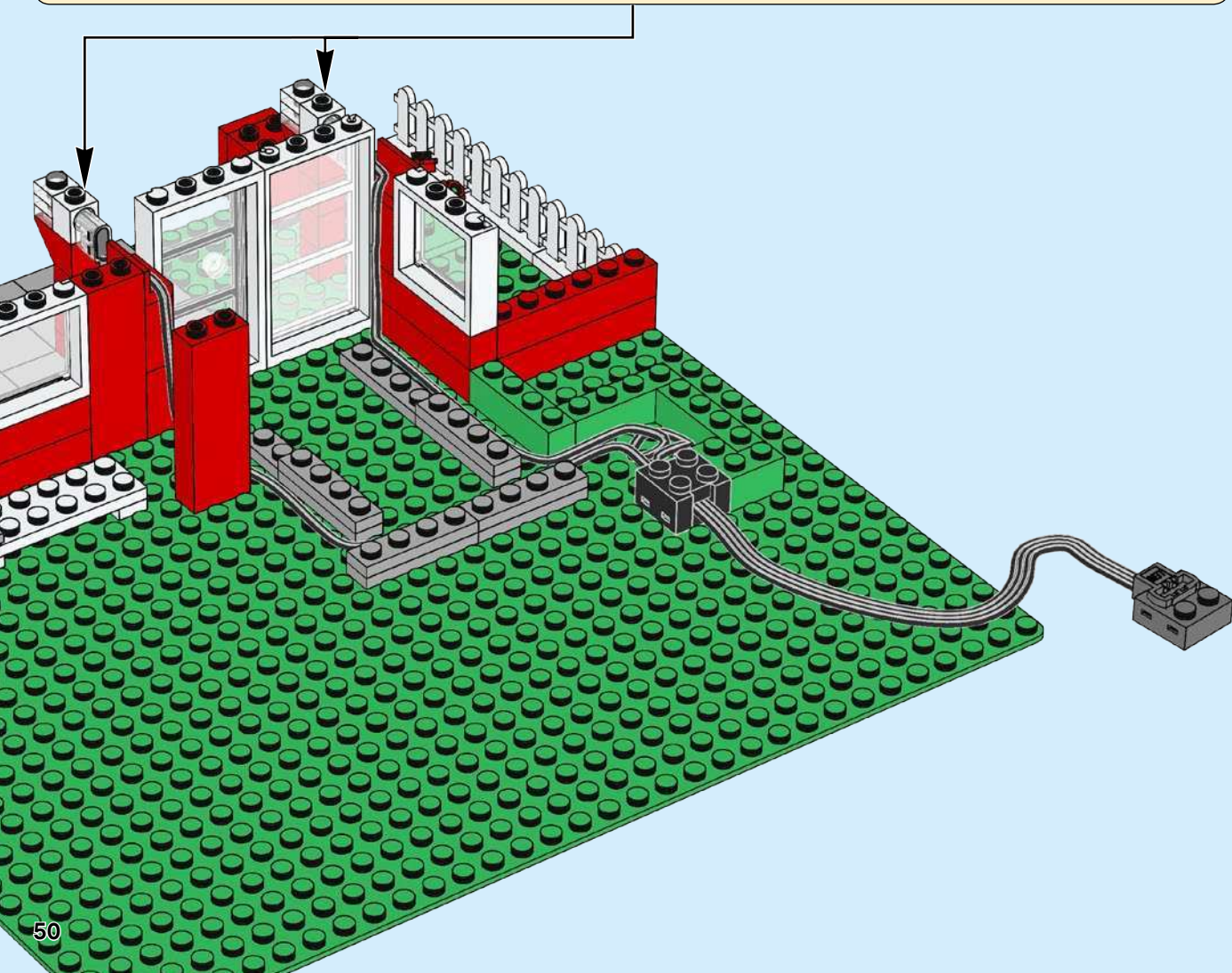
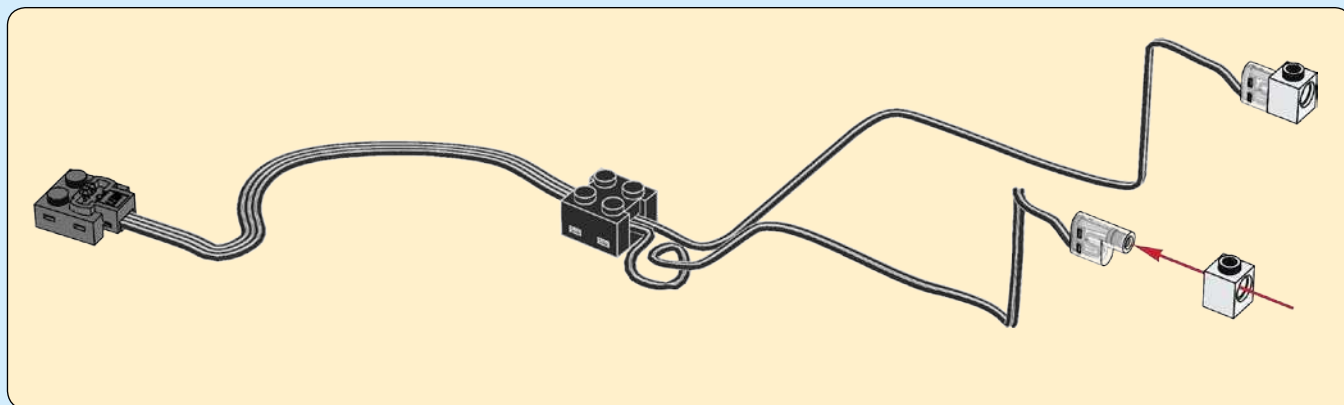

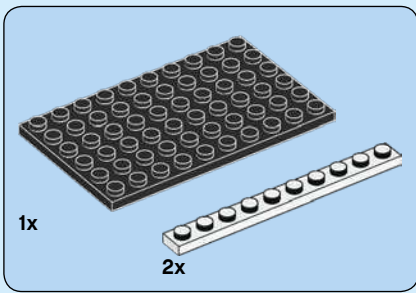

16

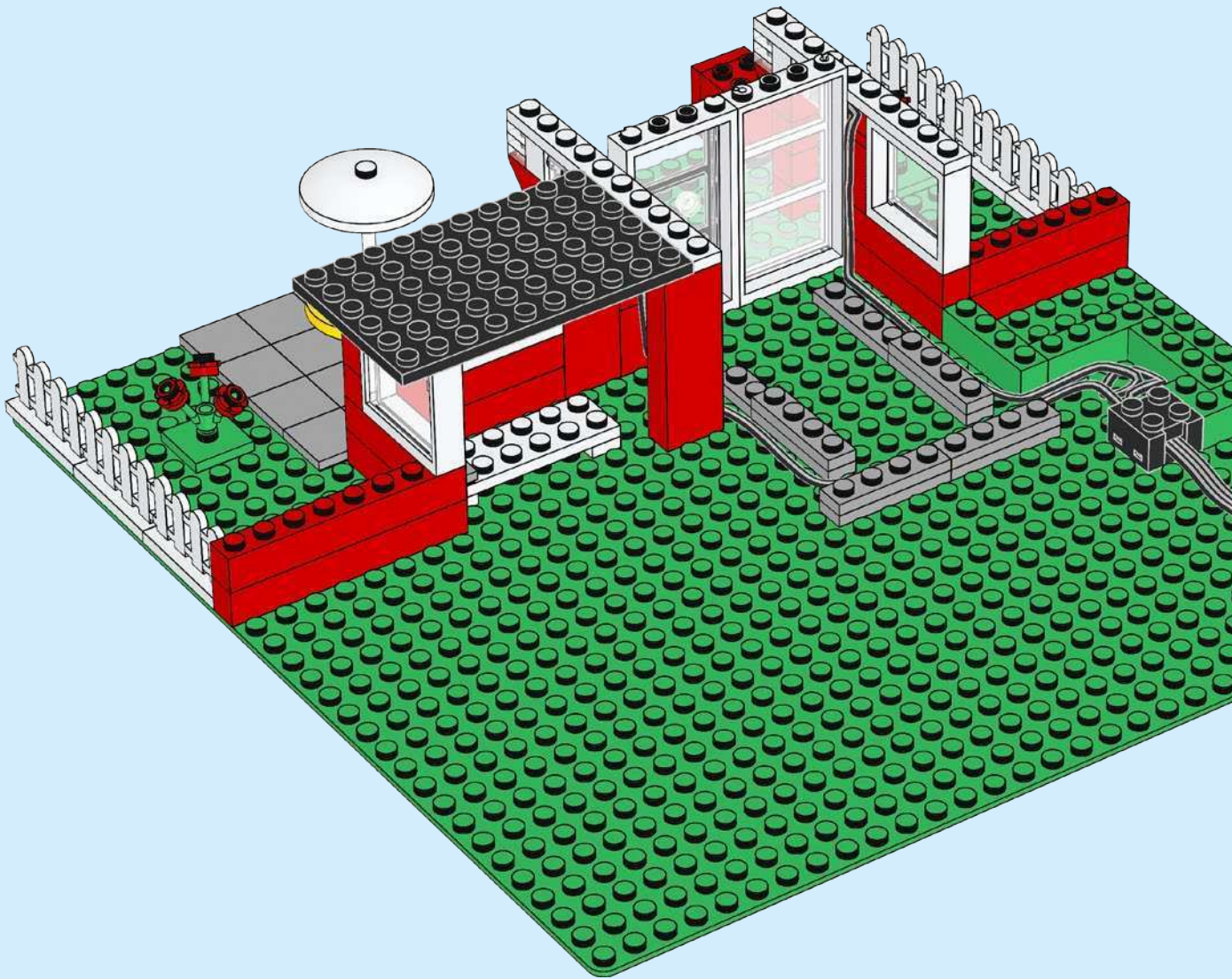

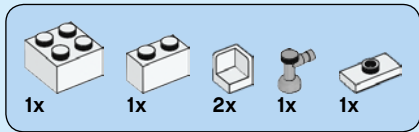

18

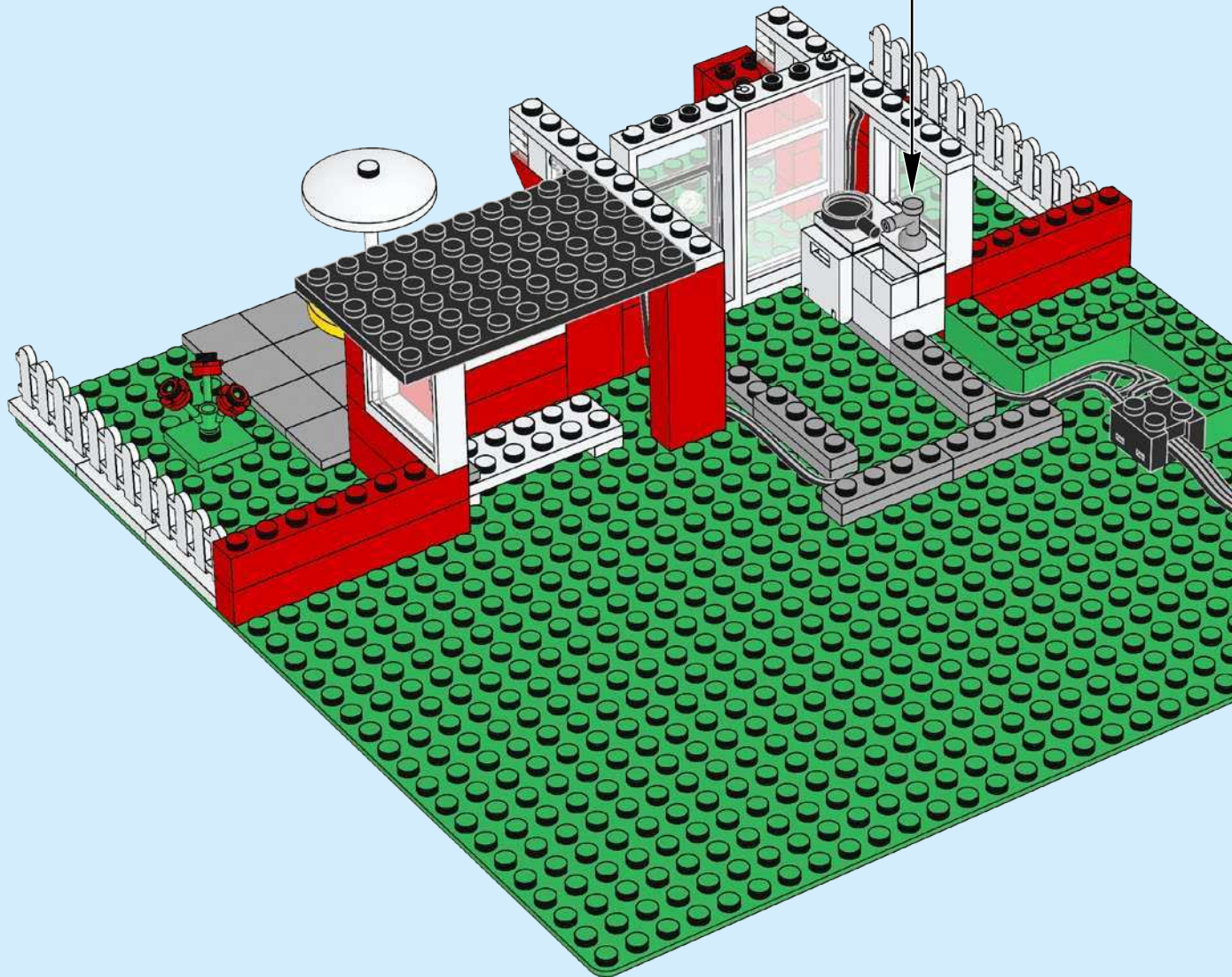
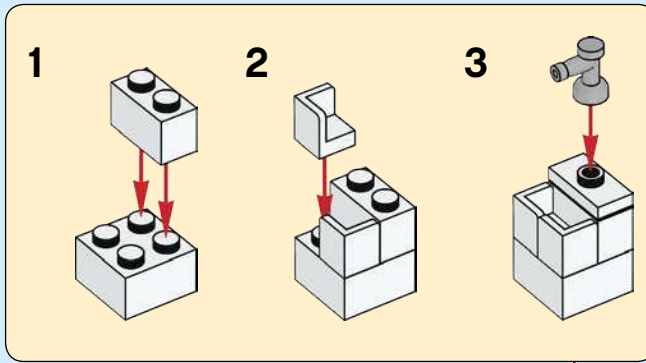

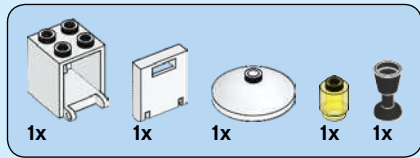

19

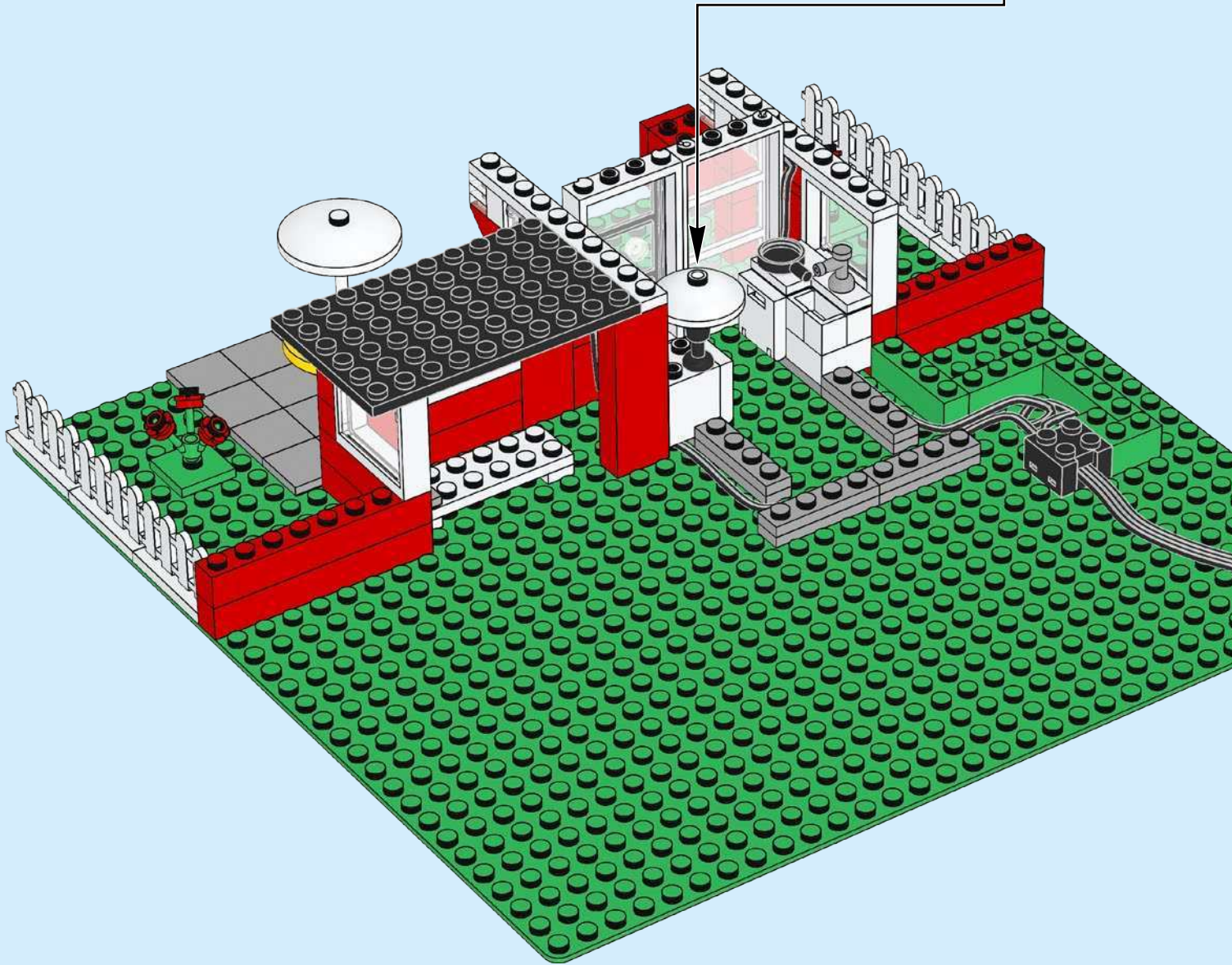
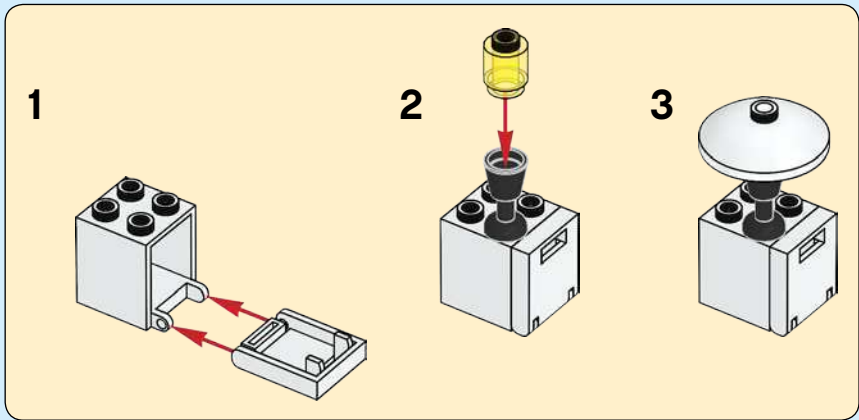

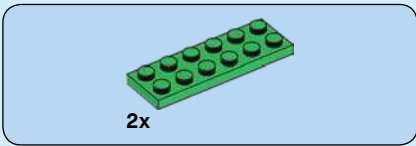

20

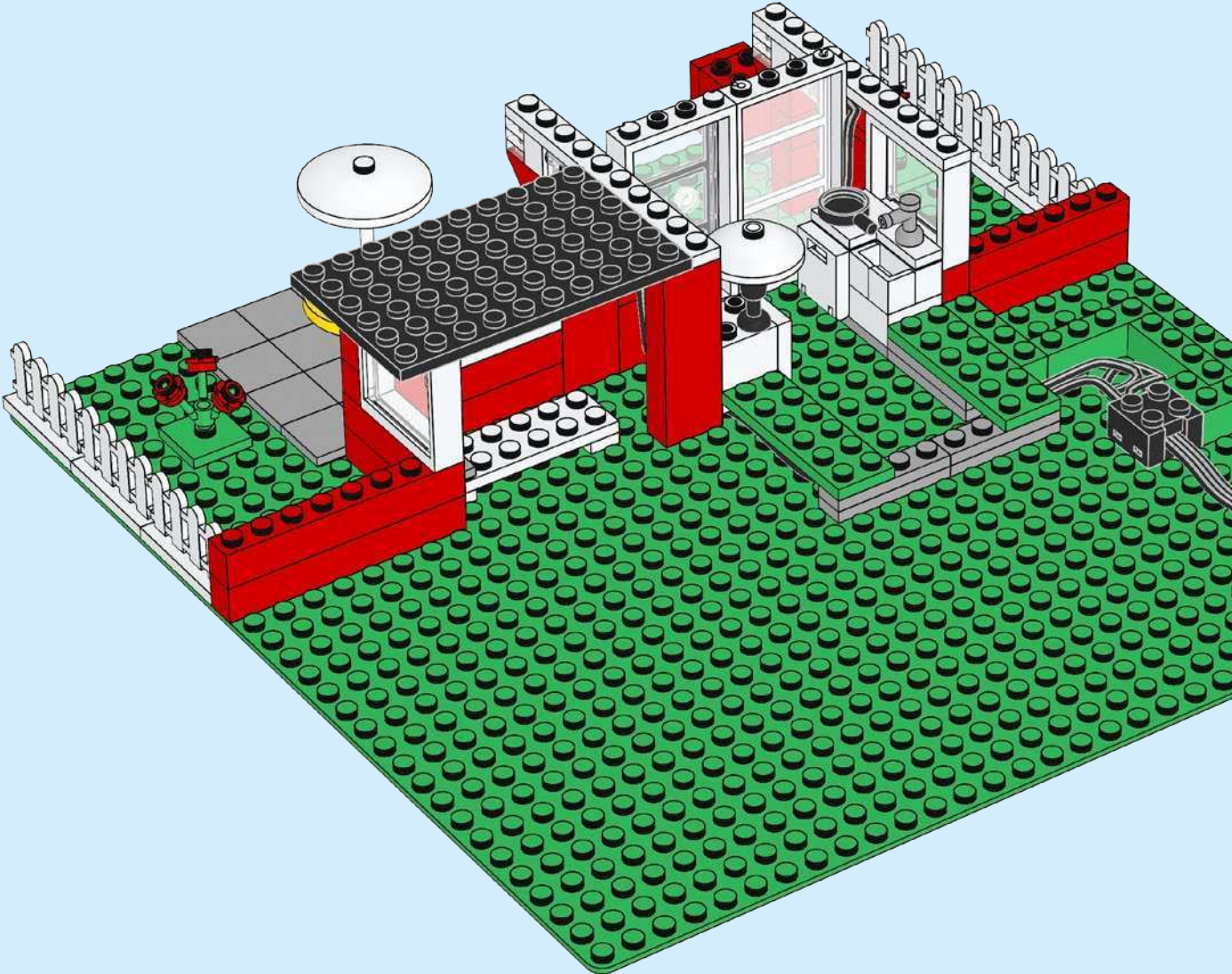

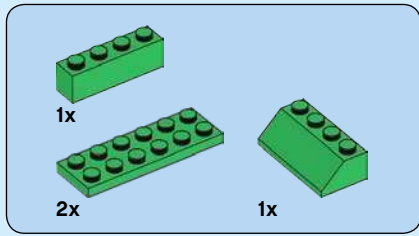

21

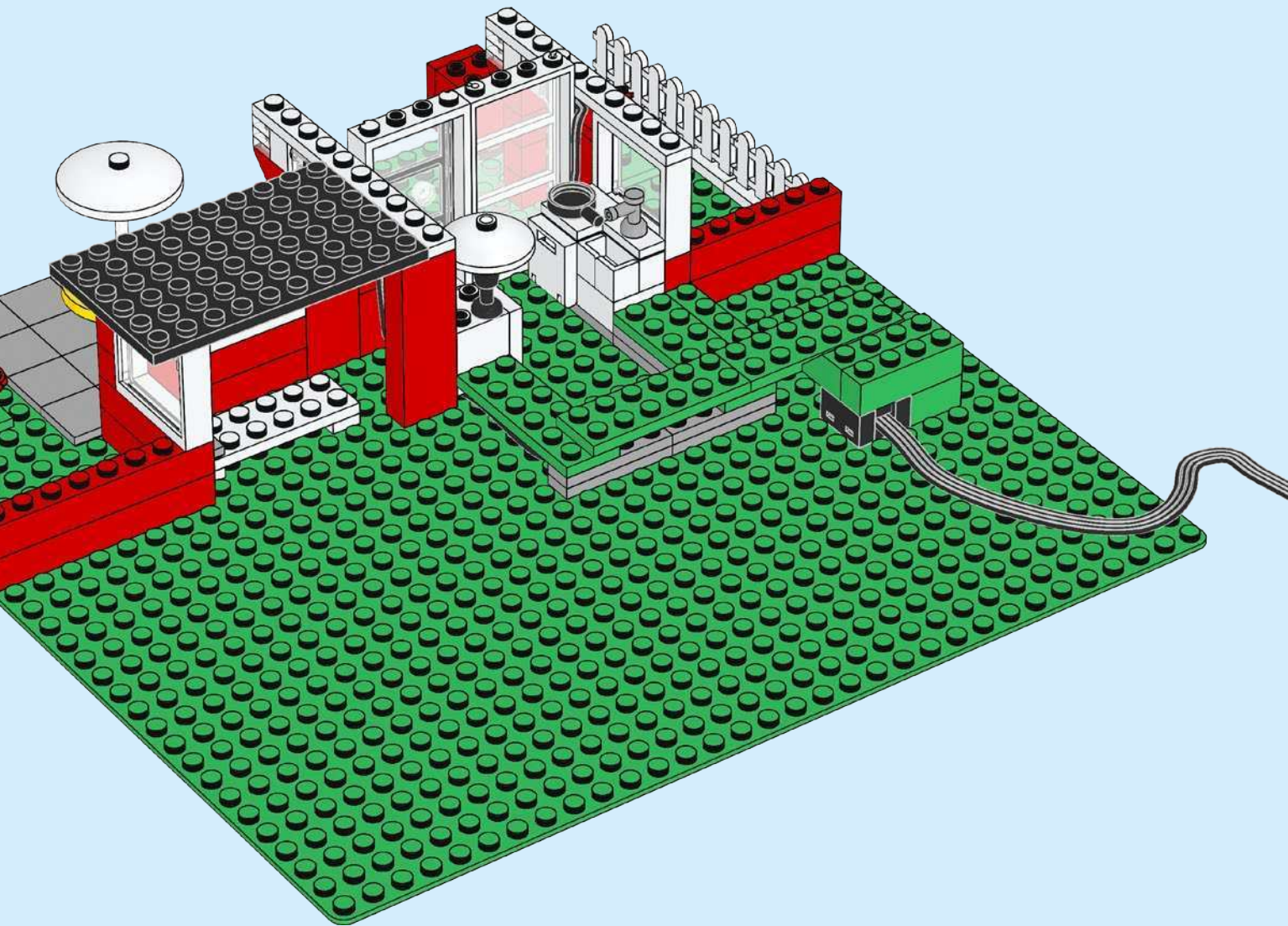

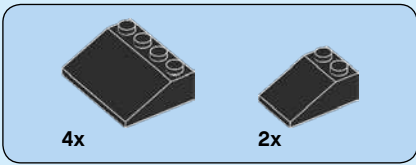

22

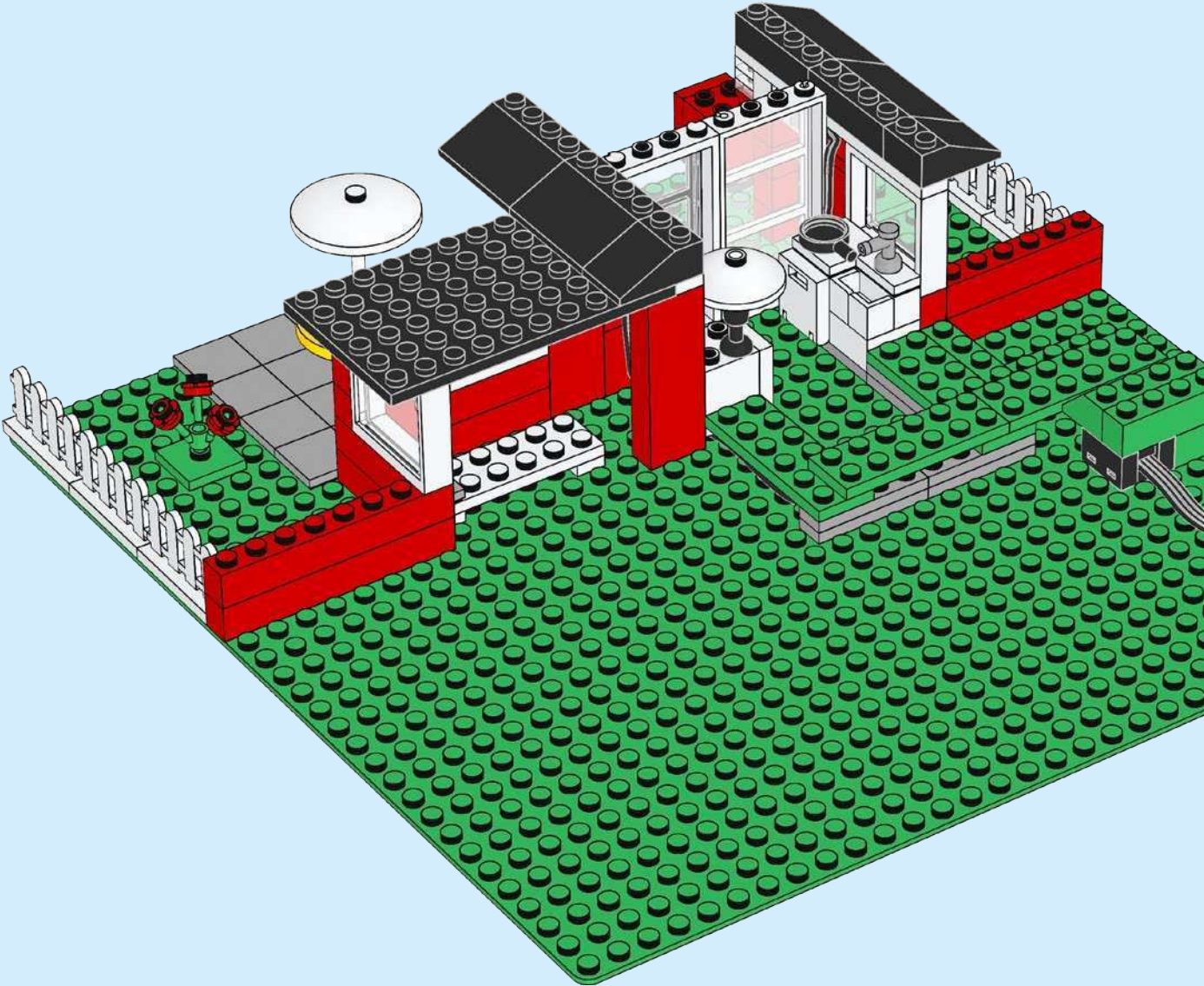

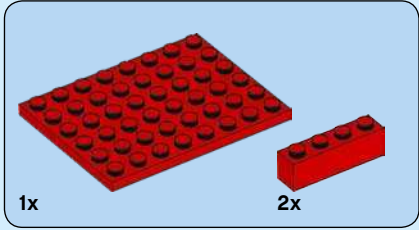
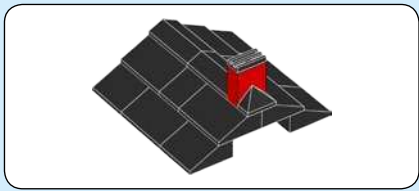

23

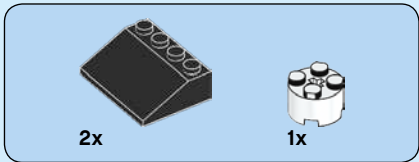
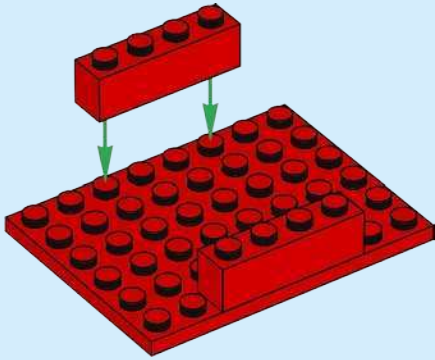

24

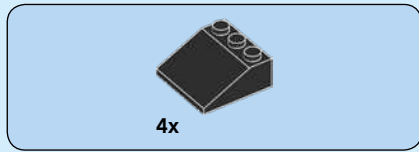
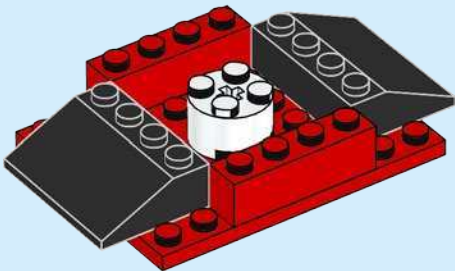

25

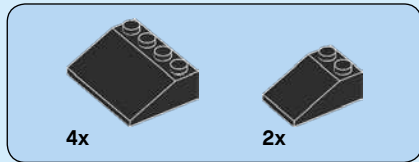
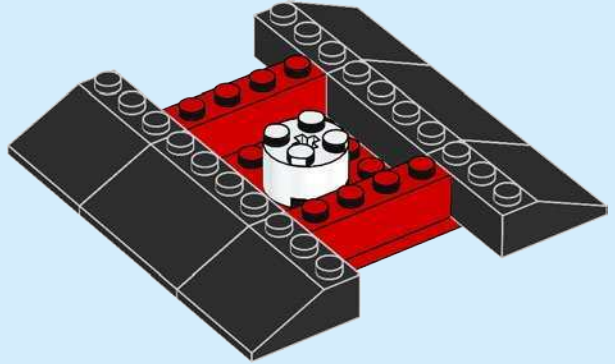

26

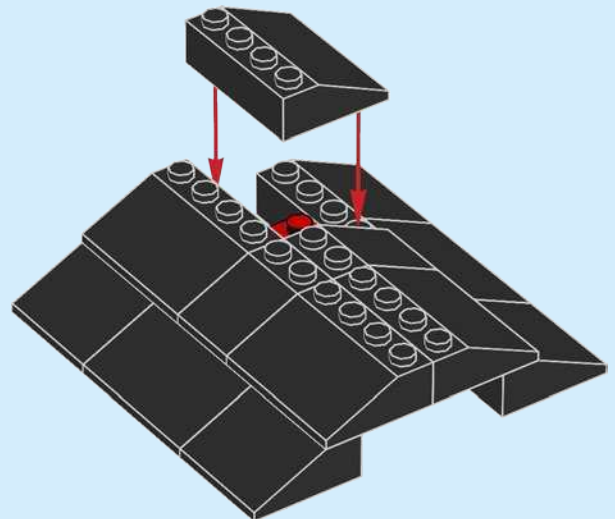

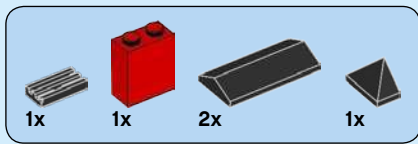

27

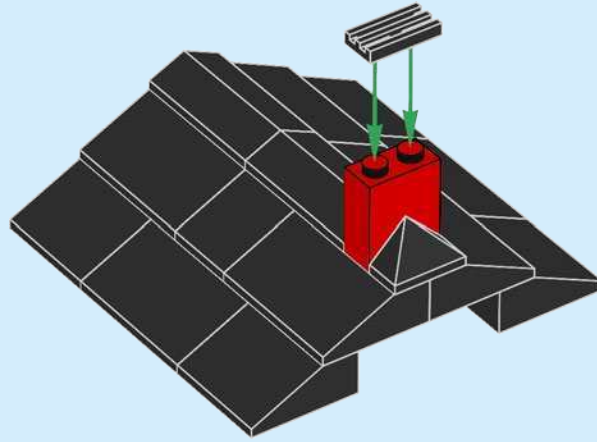

28

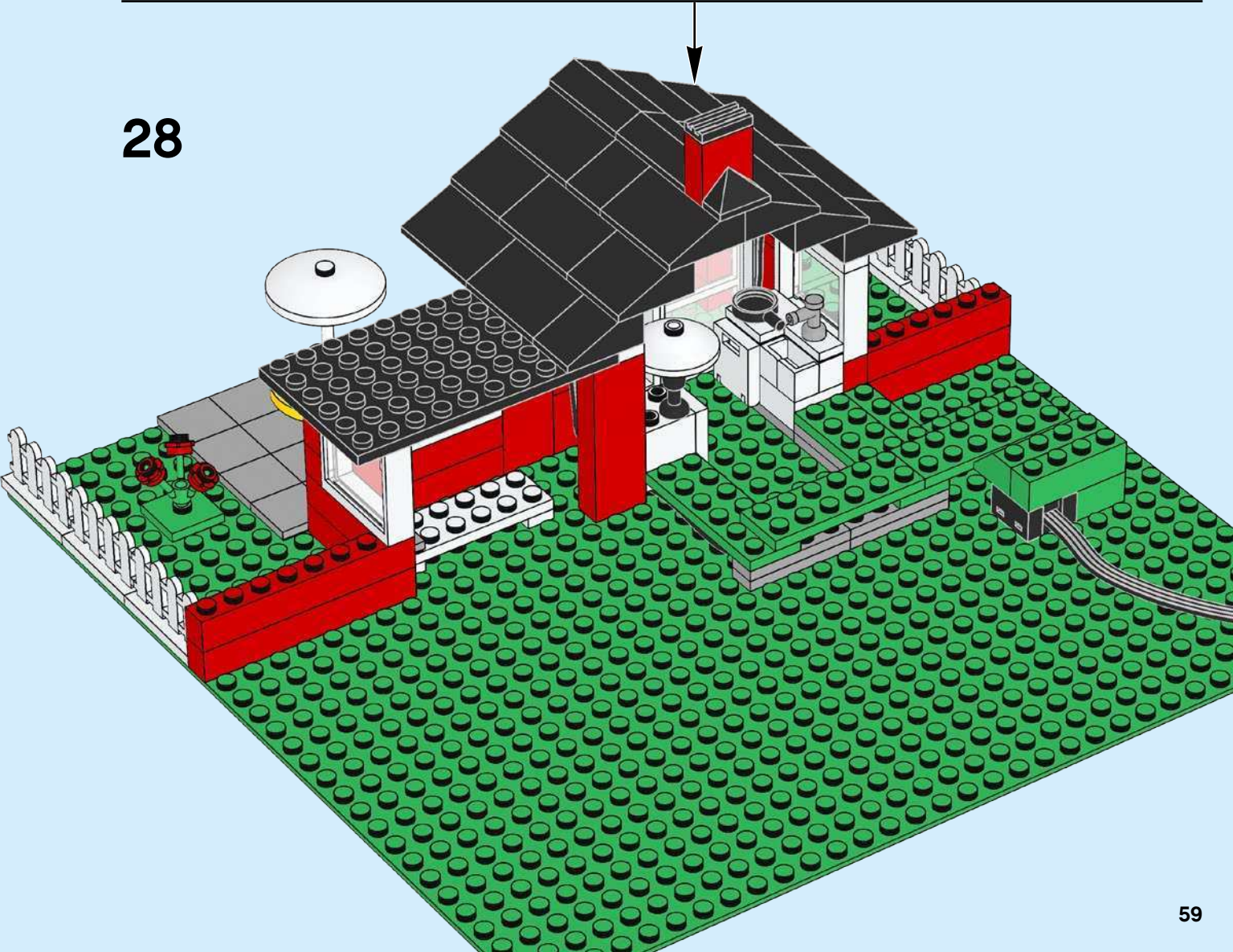

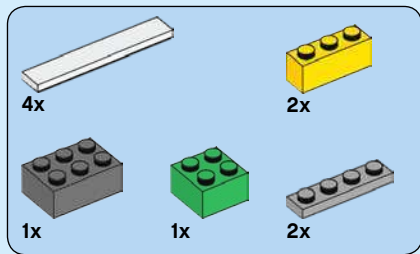

29

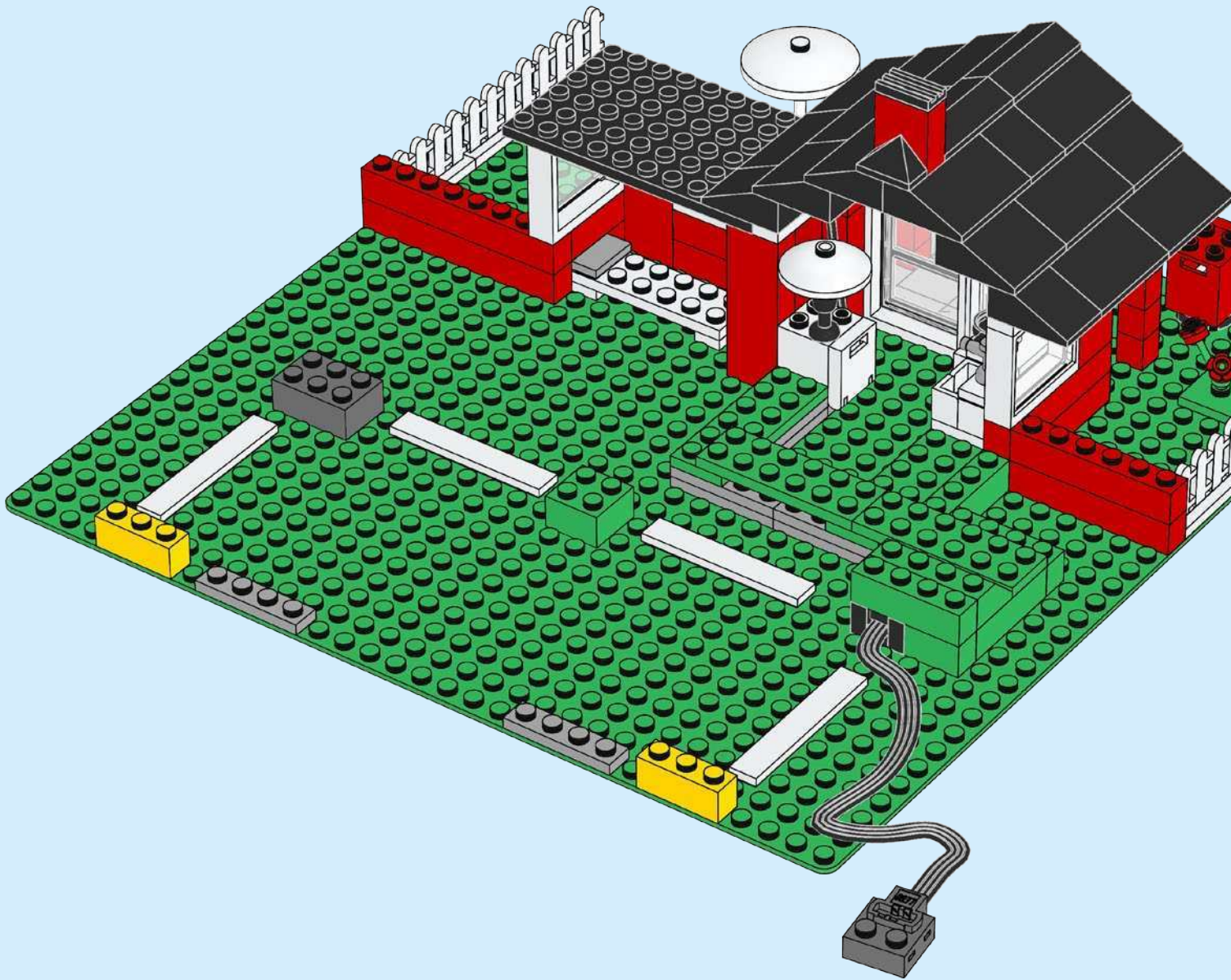

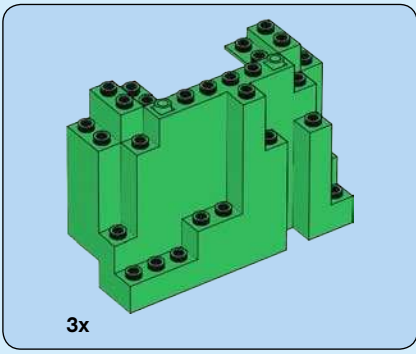

30

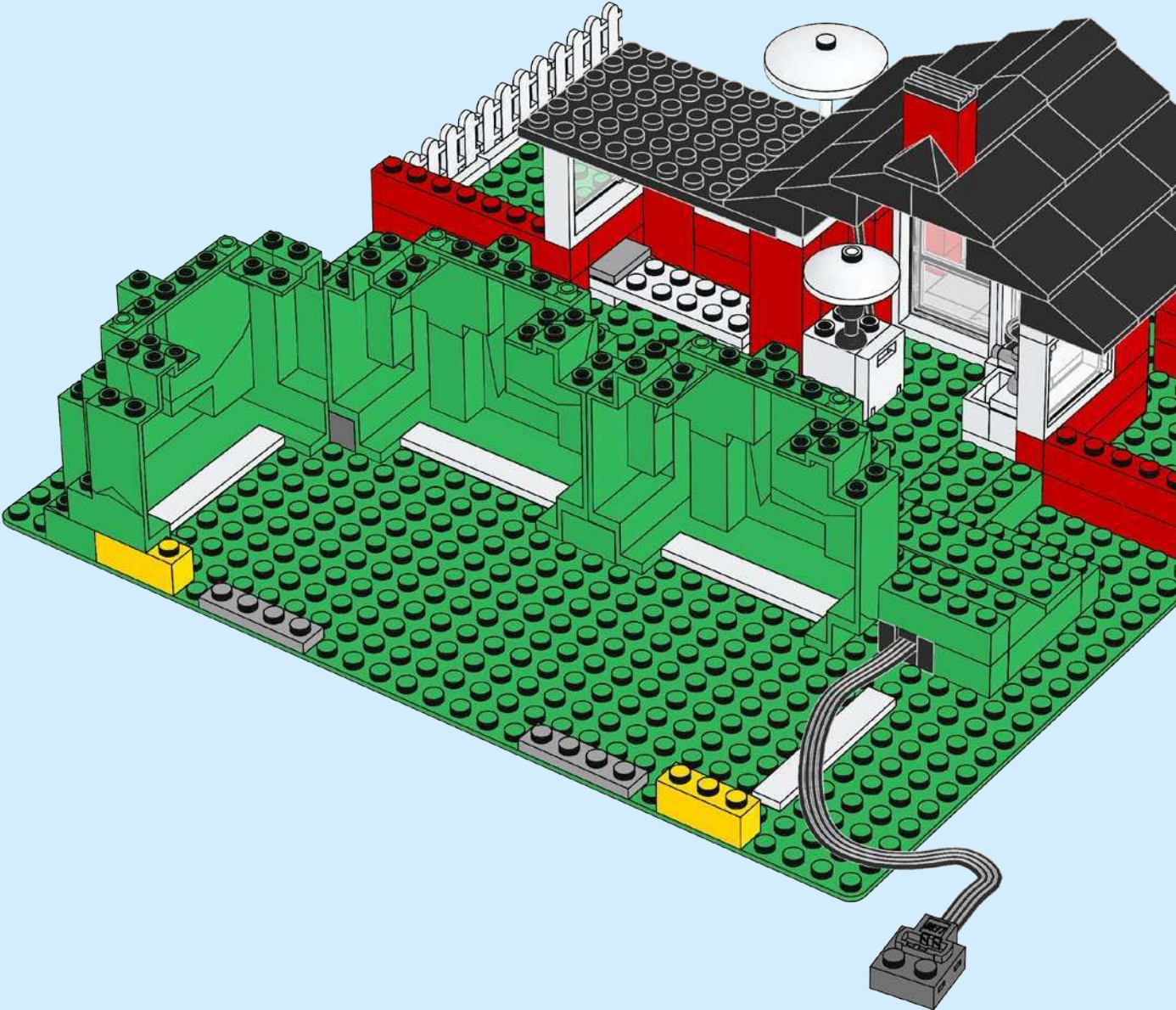

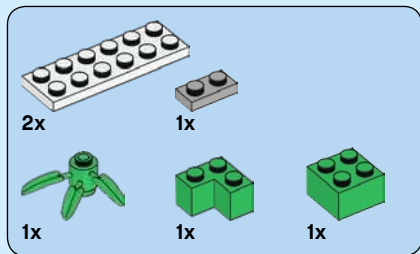

31

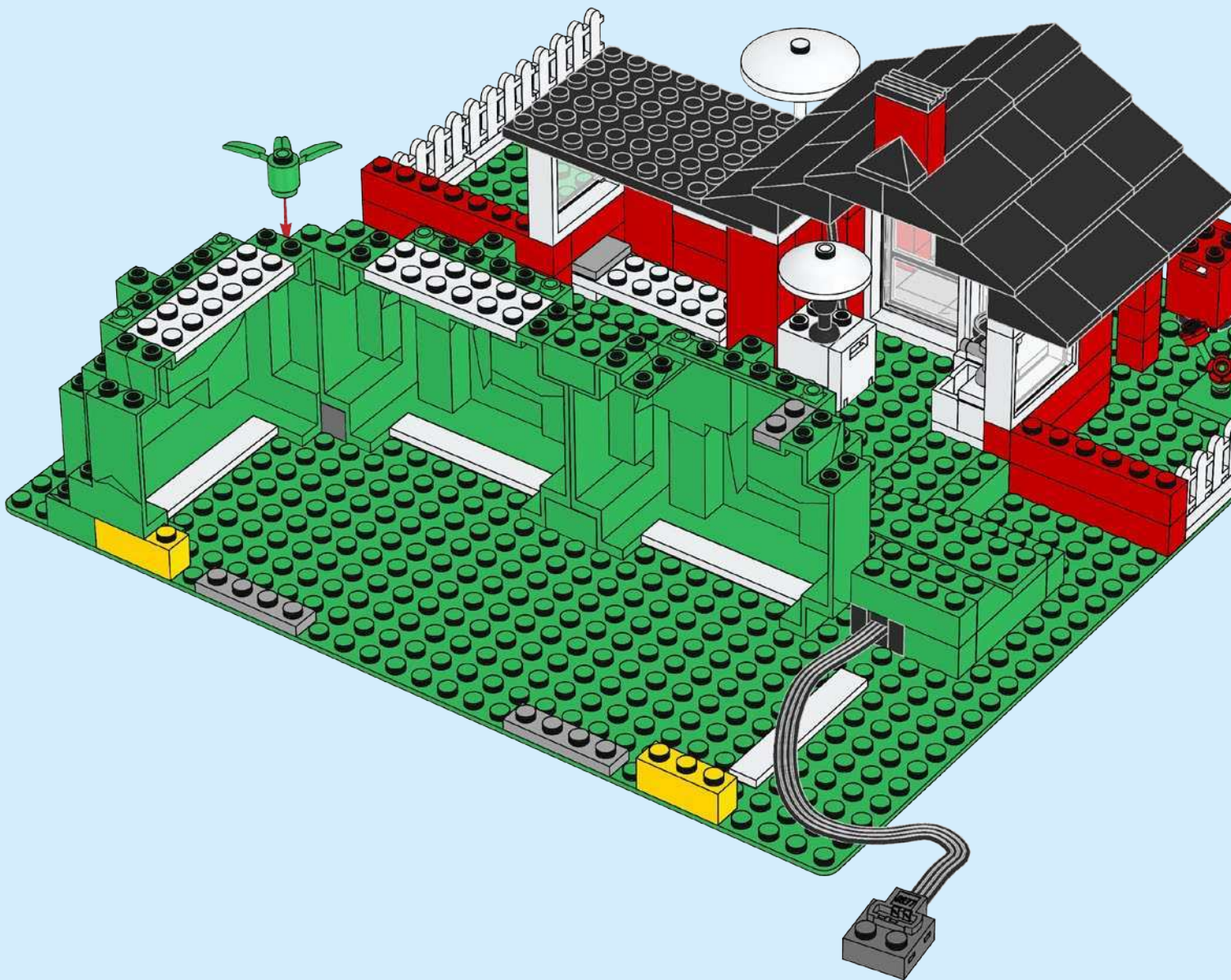

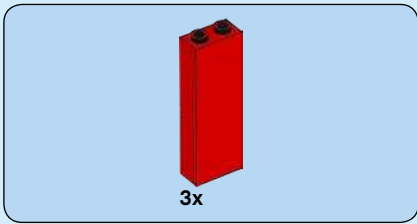

32

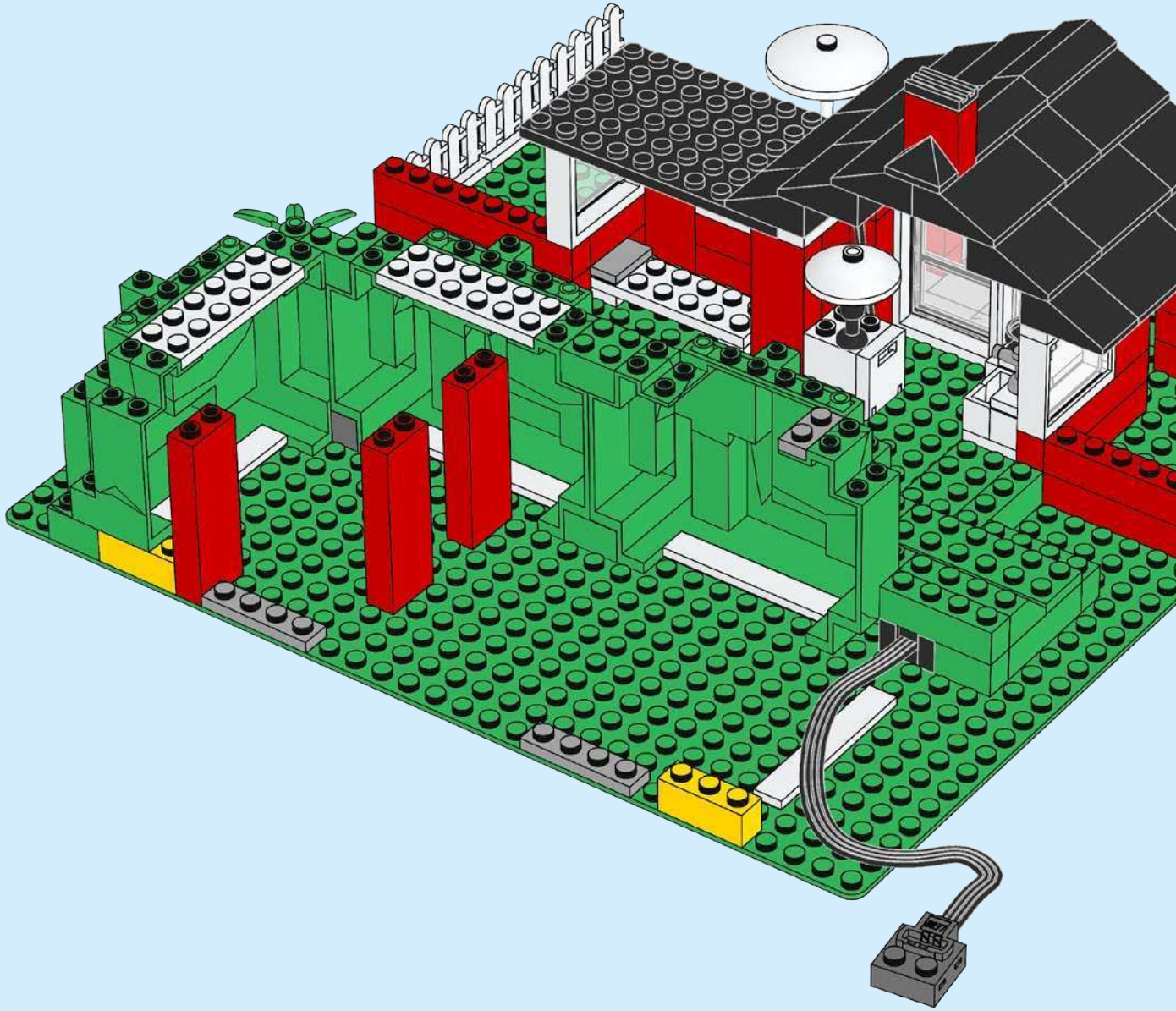

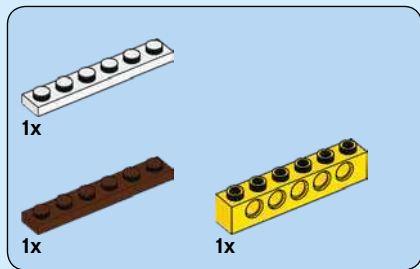

33

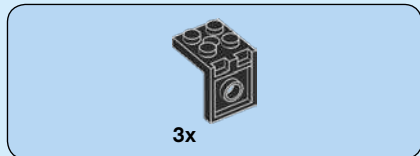
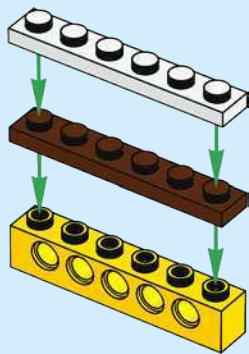

34

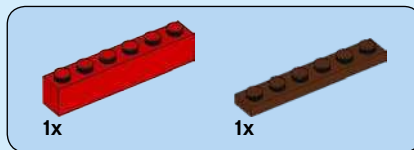
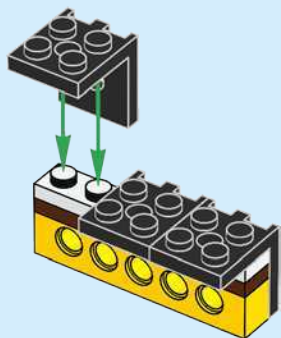

35

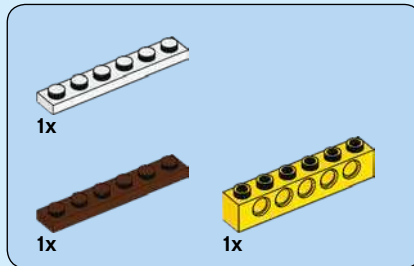
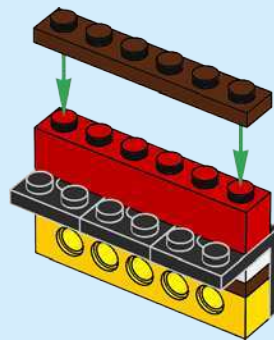

36

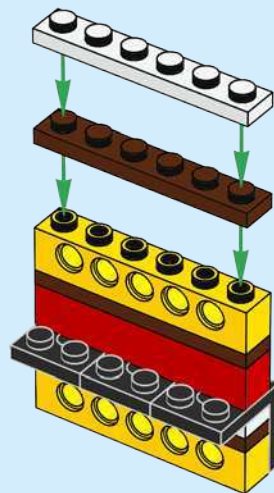

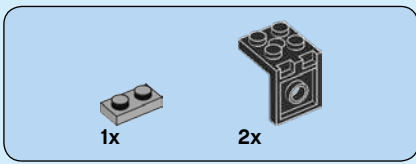

37

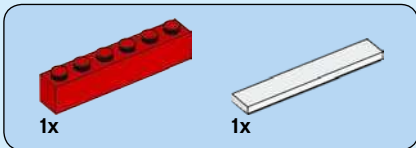
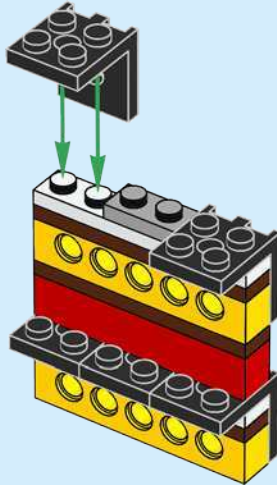

38

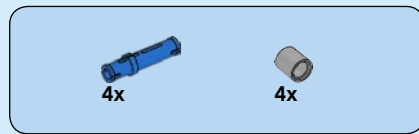
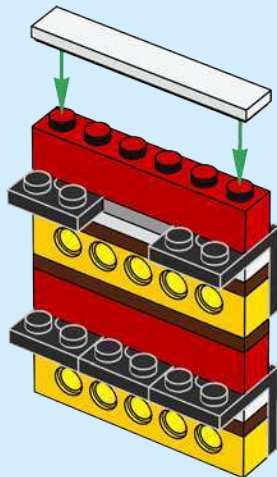

39

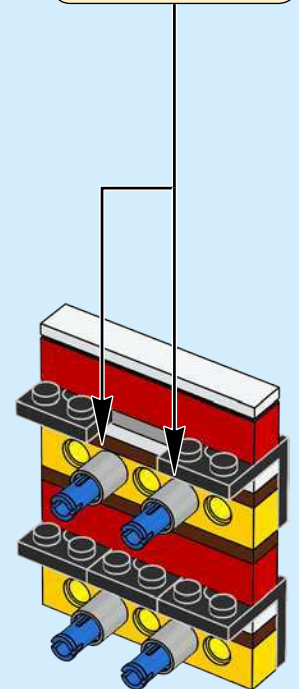
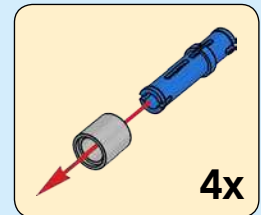

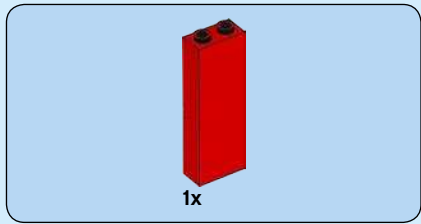

40

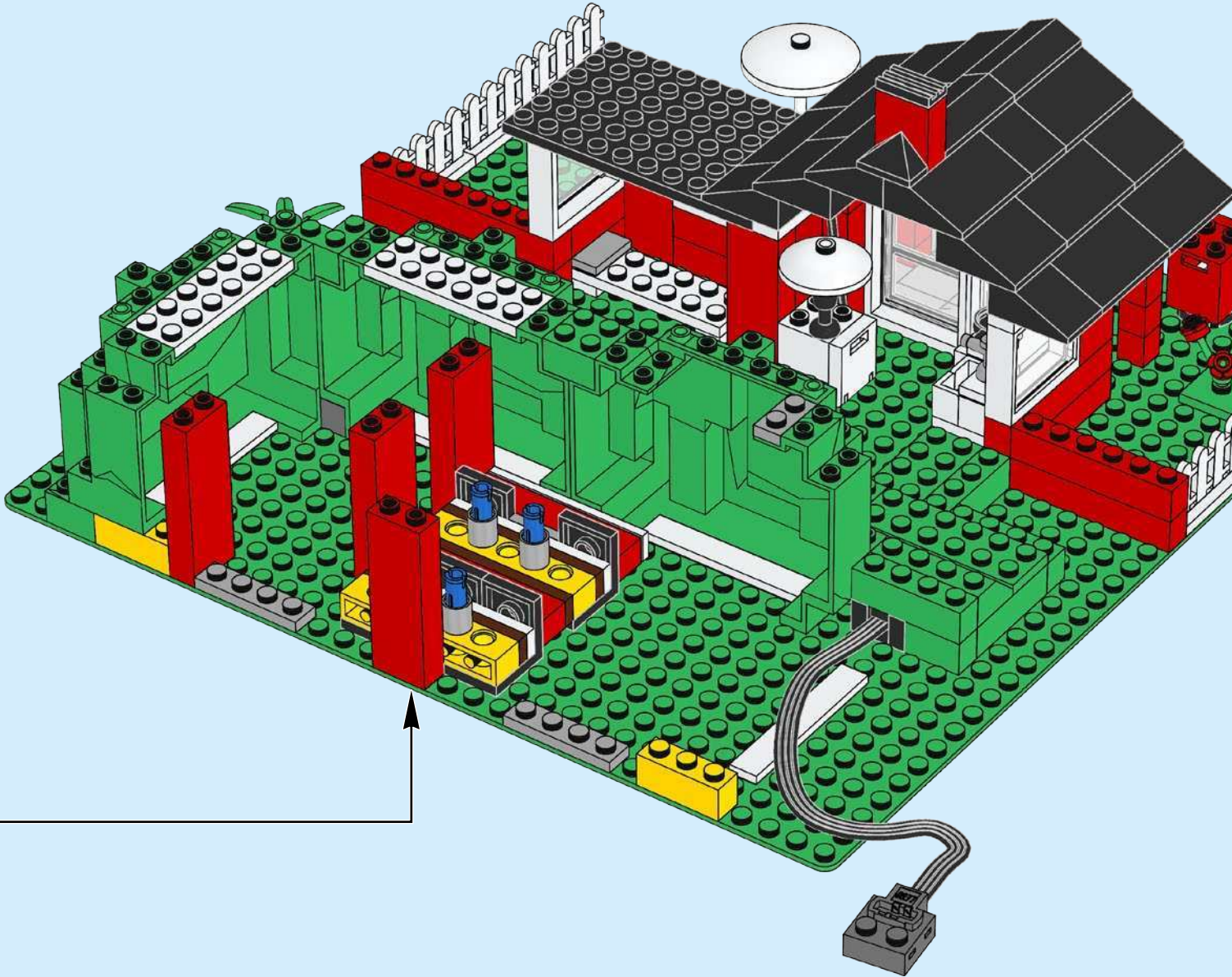

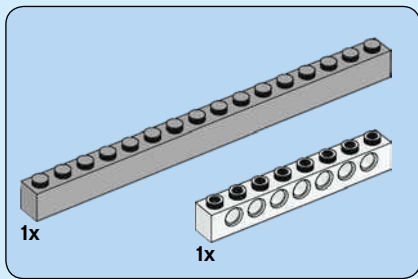

41

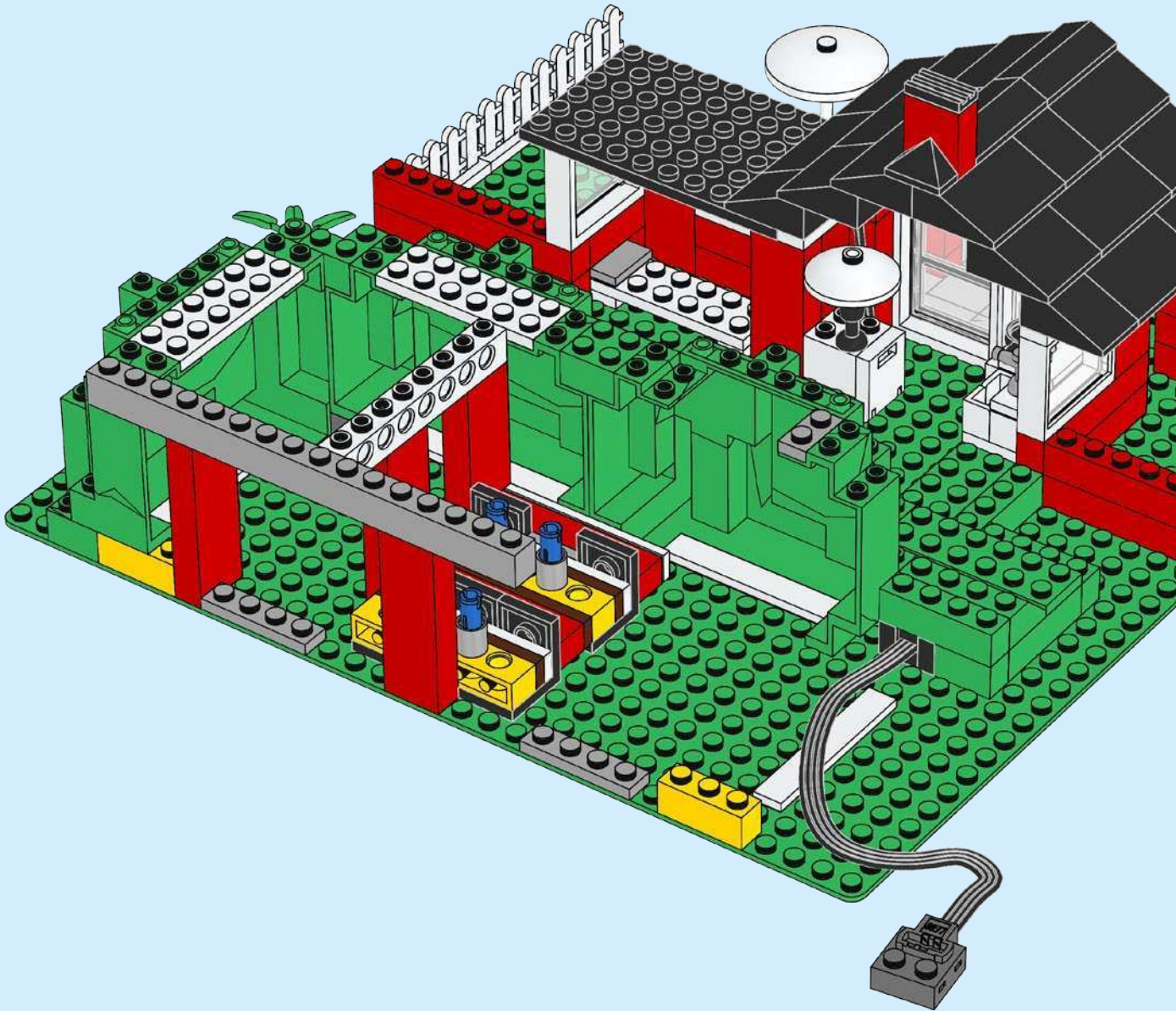

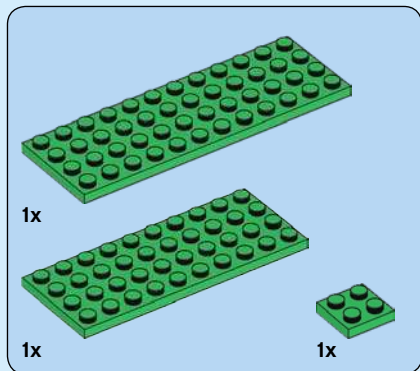

42

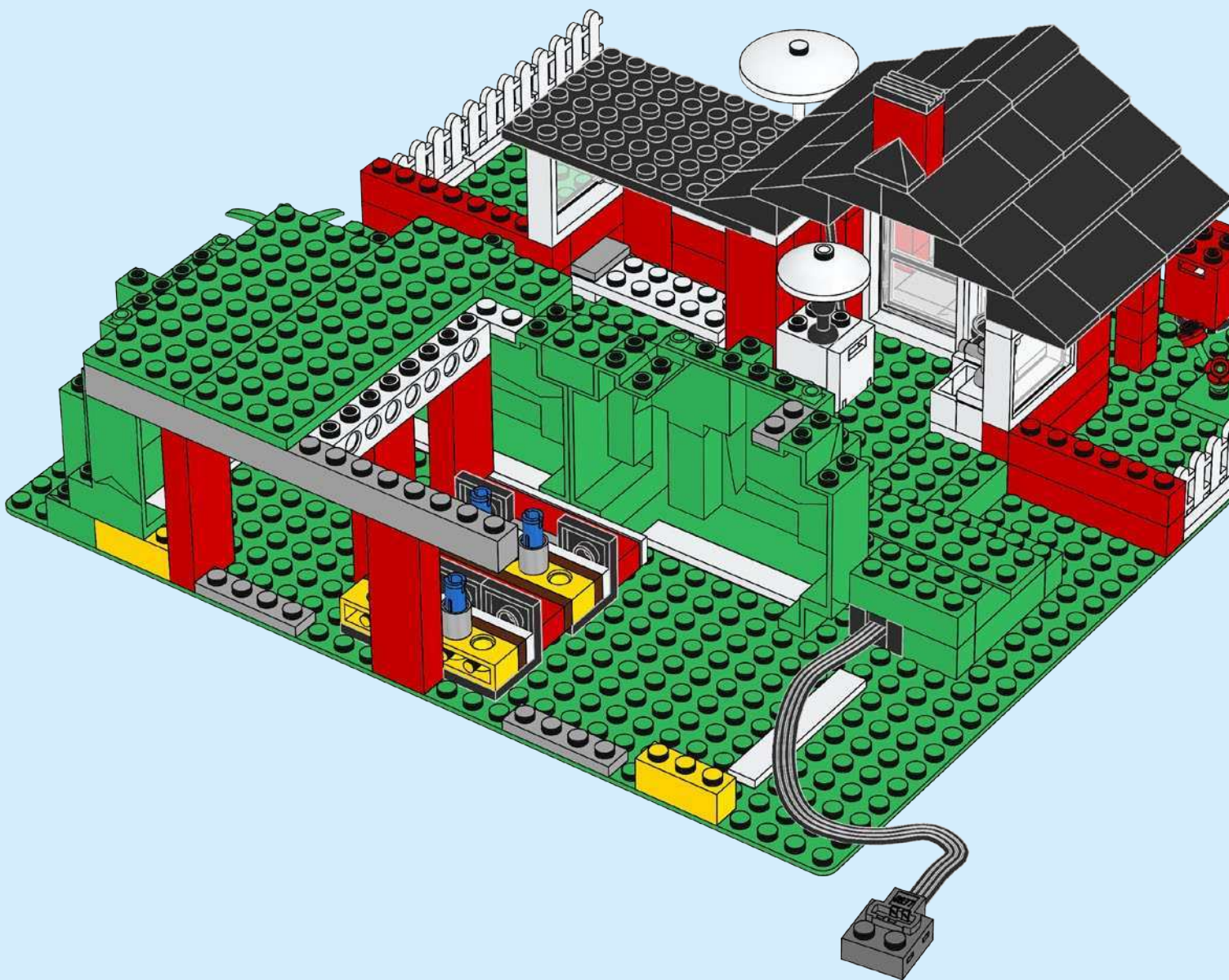

*+1,900 households can be powered every year,
in Europe with only one V90-2.0 MW™
Vestas wind turbine.*

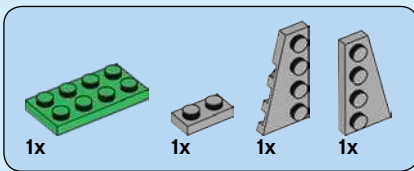

43

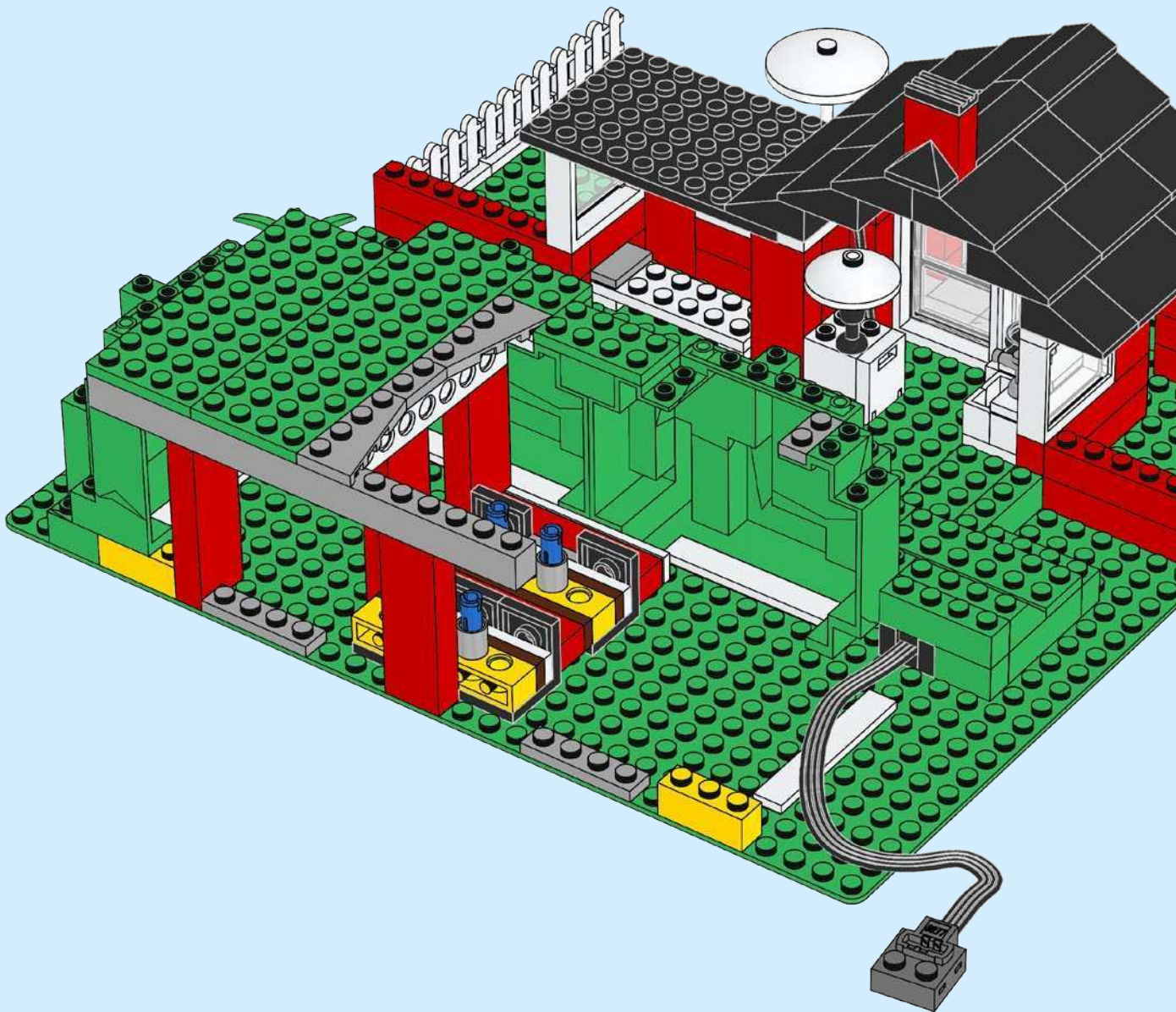

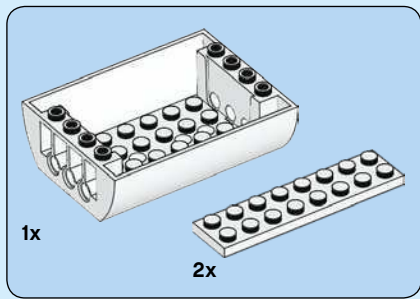
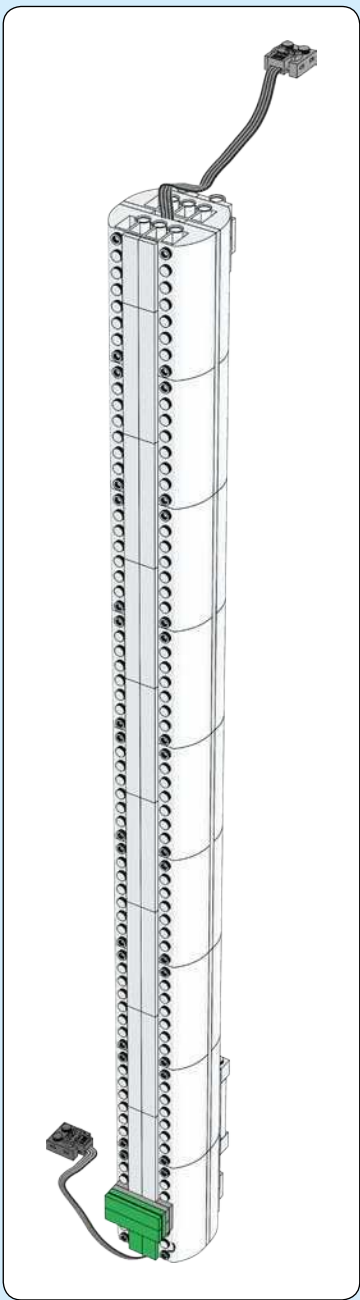

44

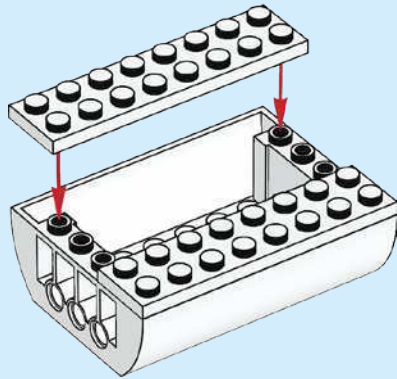

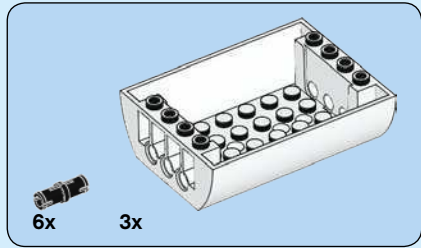

45

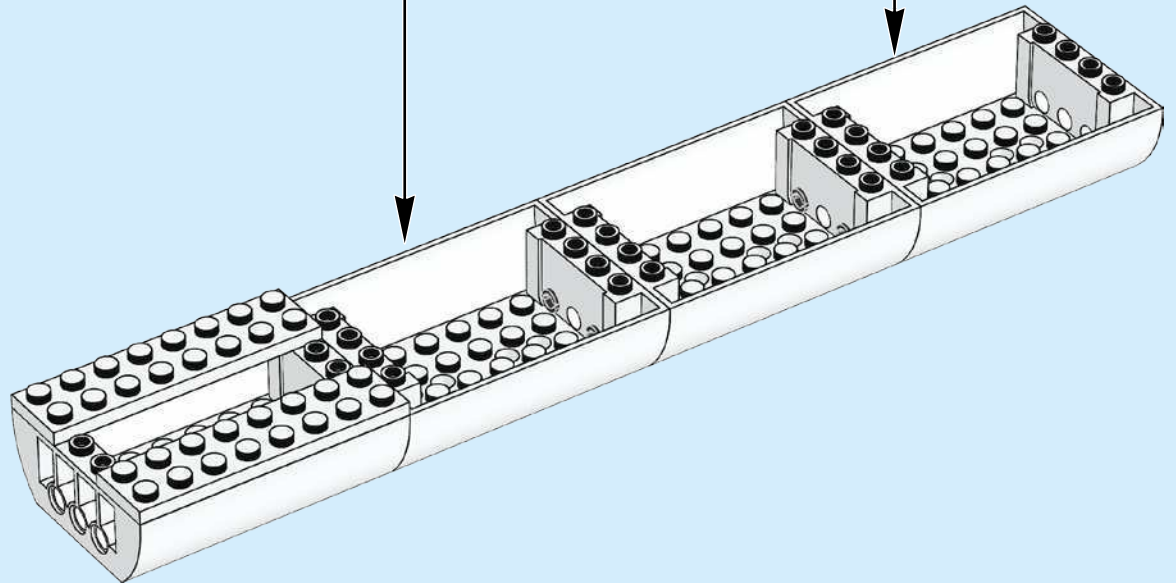
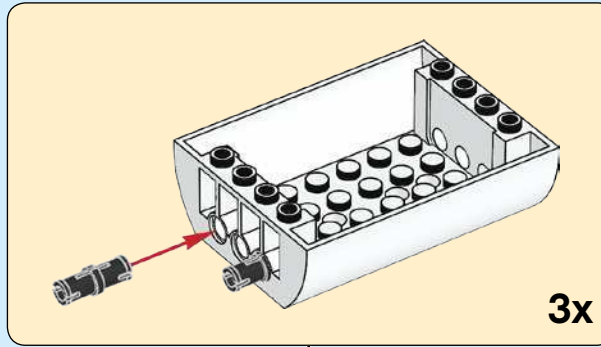

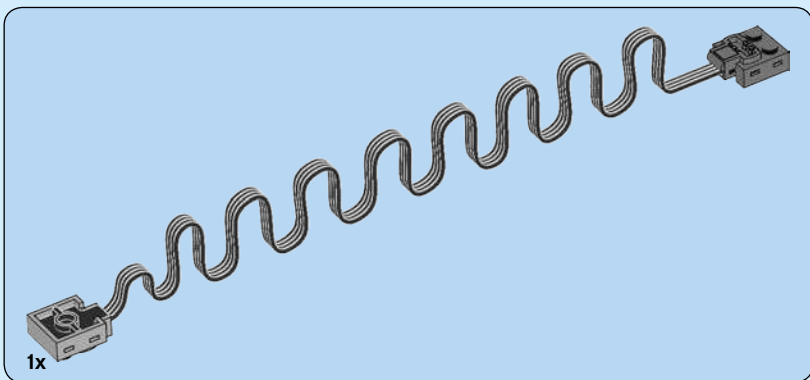
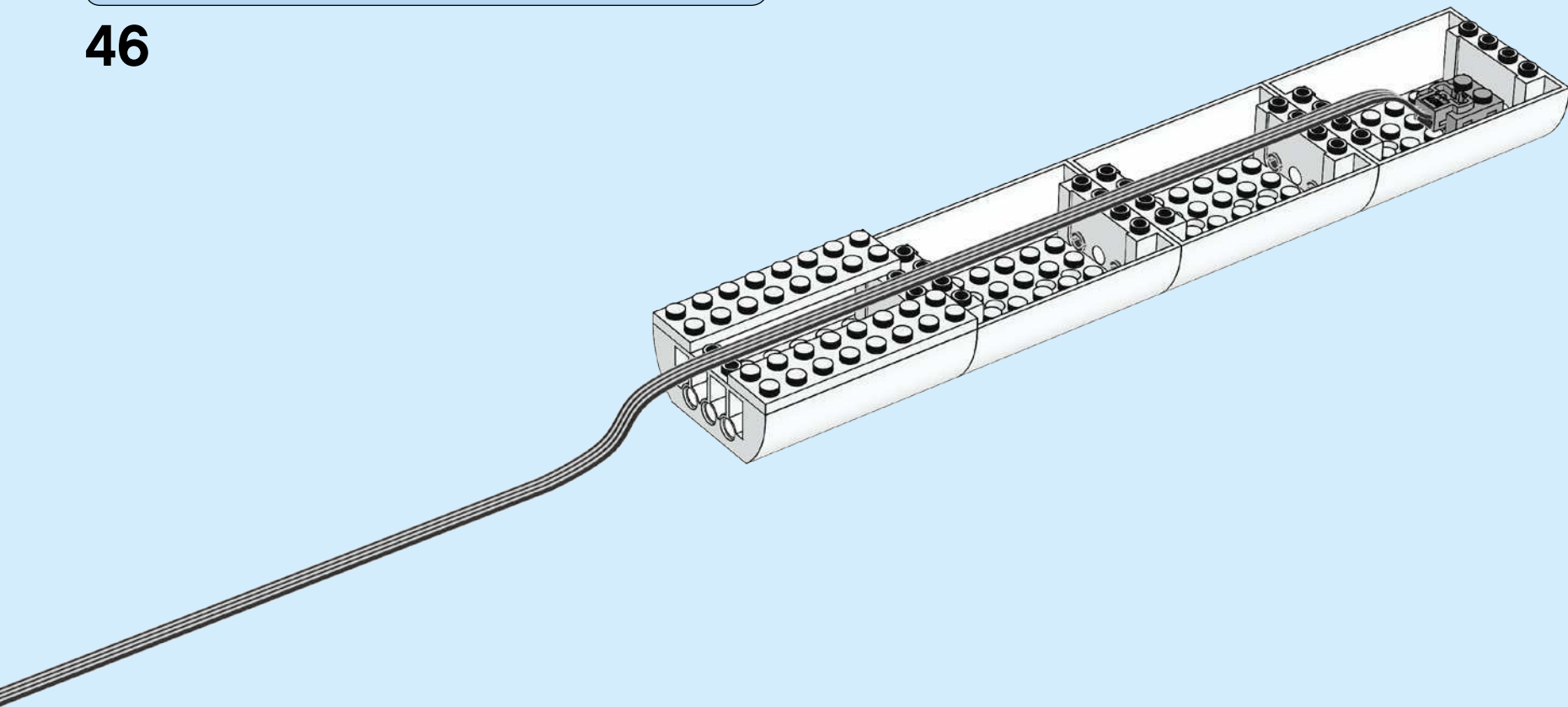
**46**

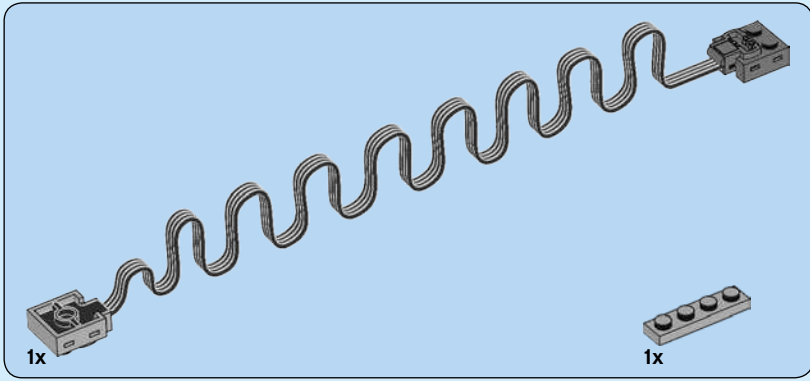

47

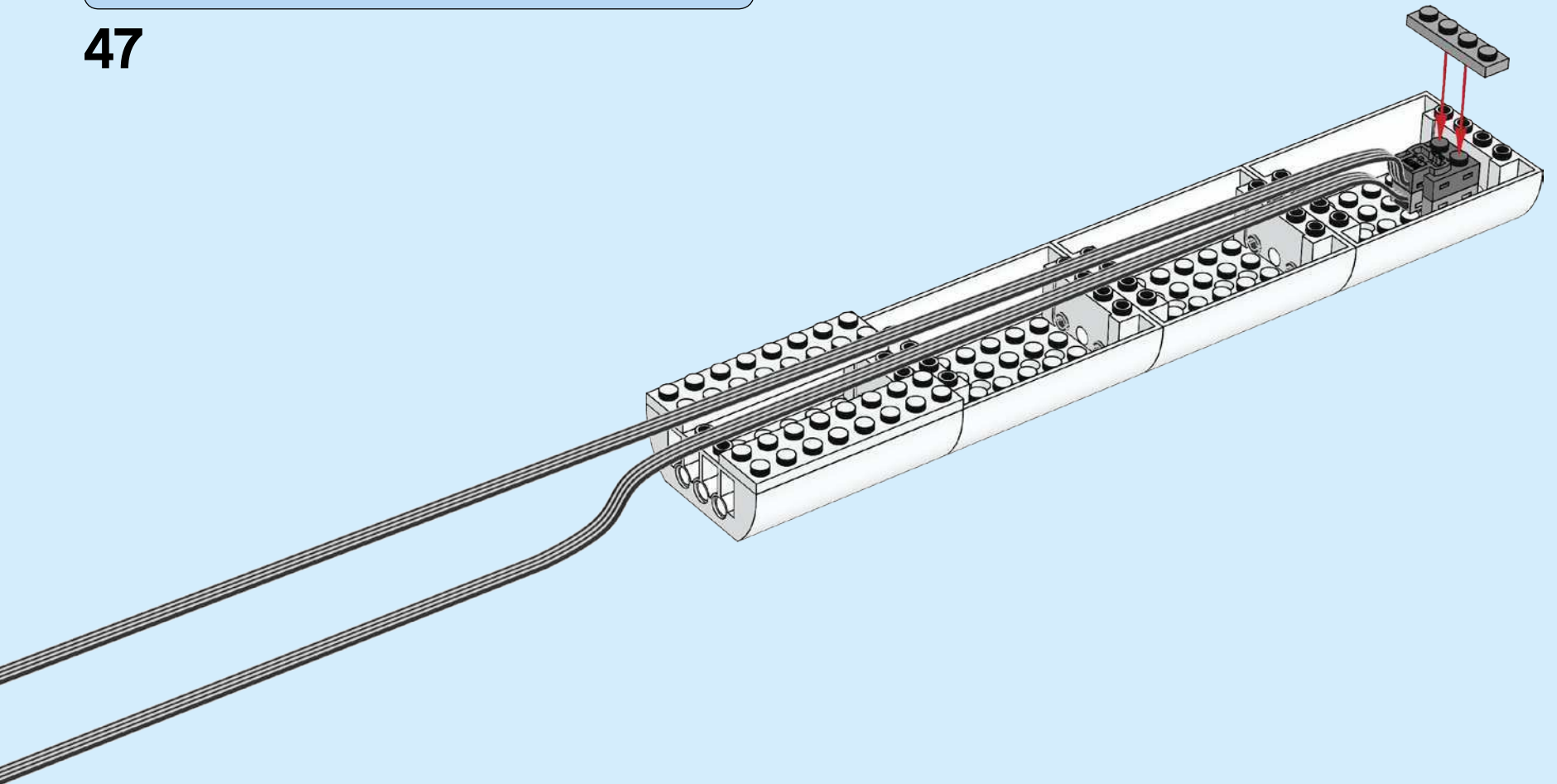

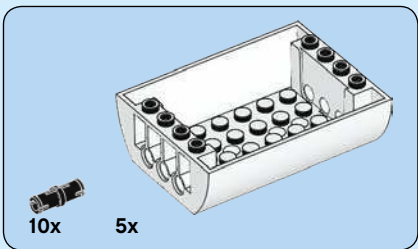

48

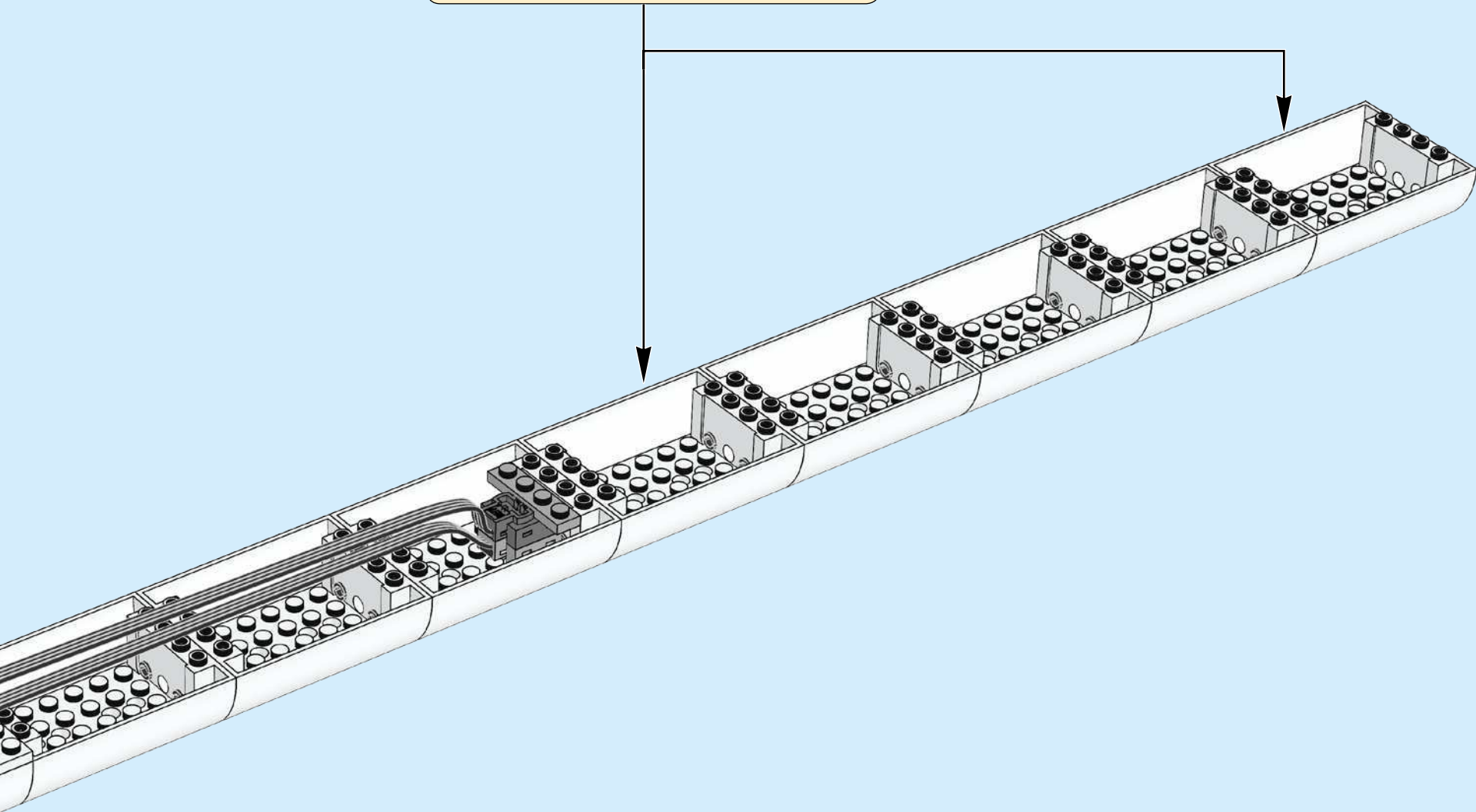
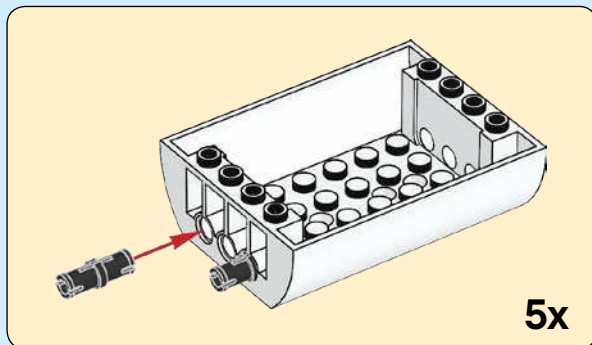

*A single Vestas wind turbine will generate
around 25 to 50 times more energy
than it uses in its entire lifecycle.*

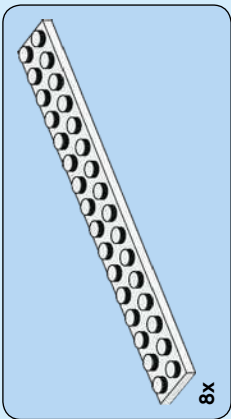
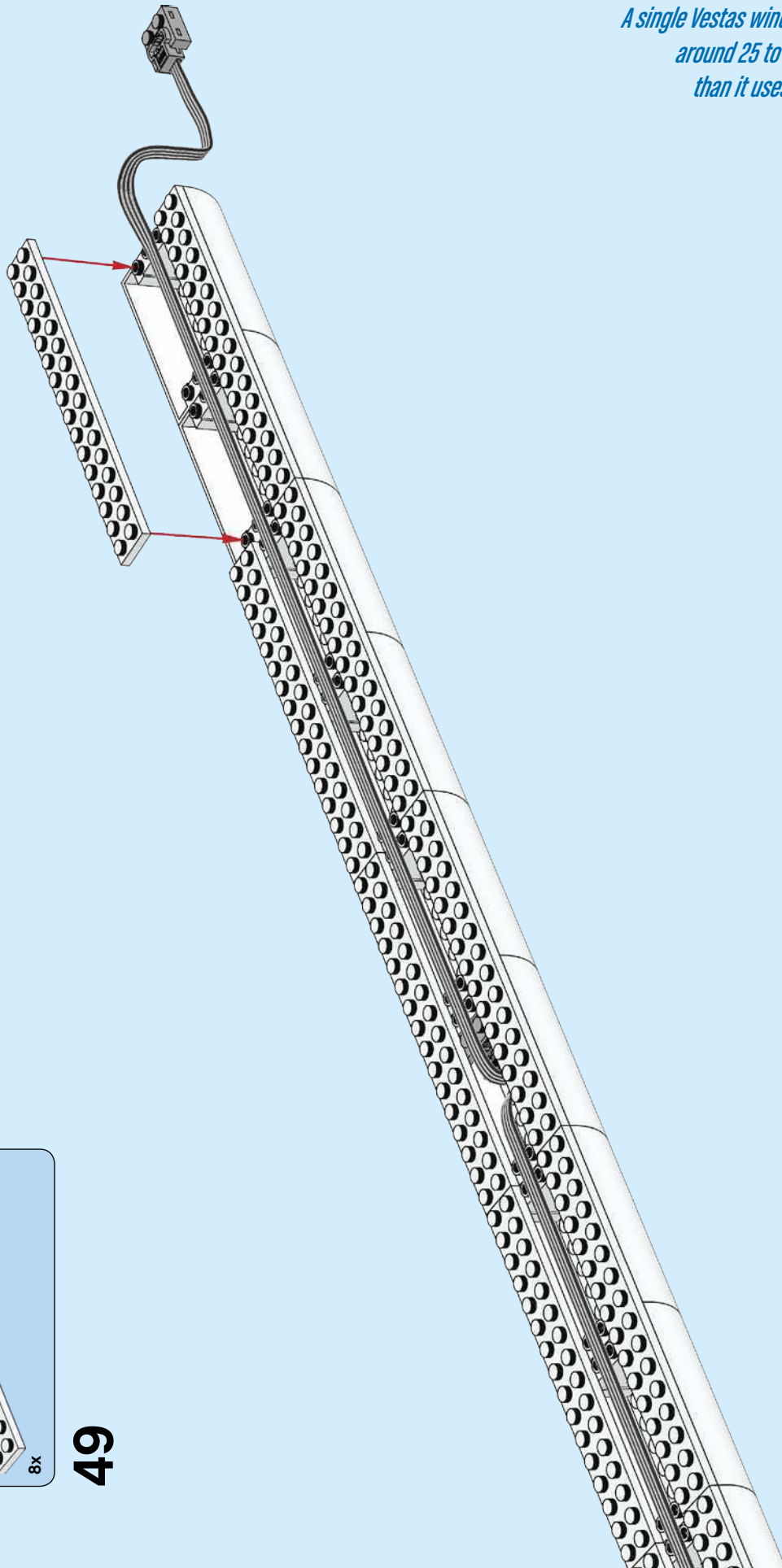

49

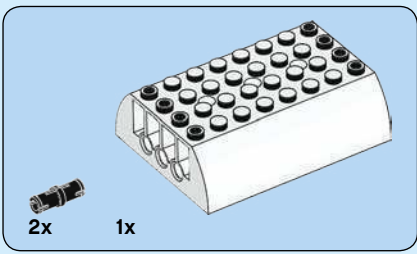

50

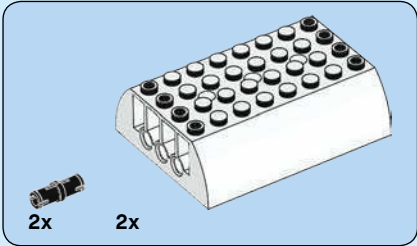
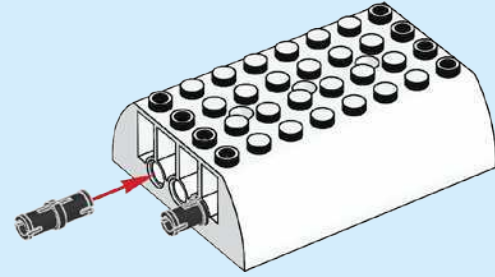

51

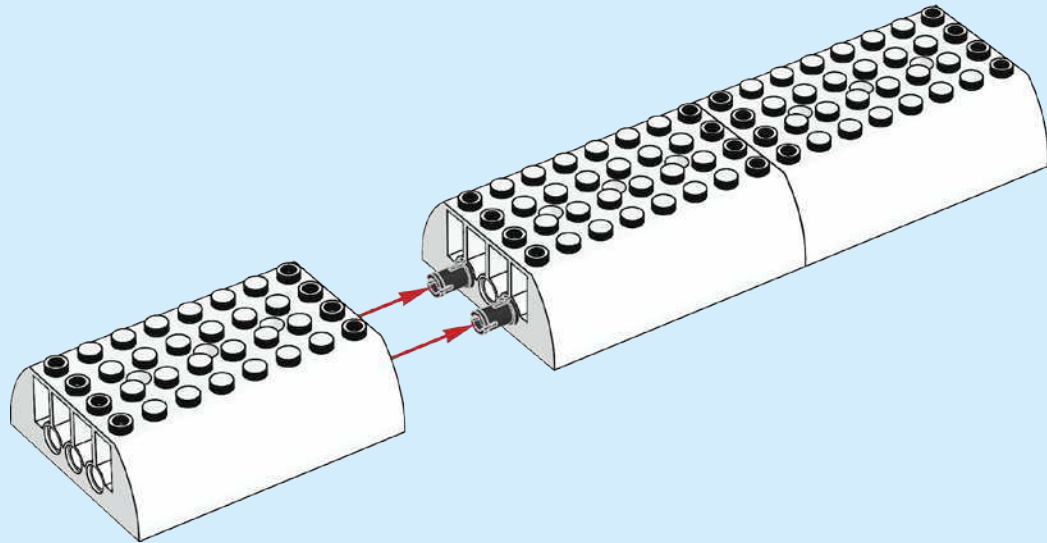

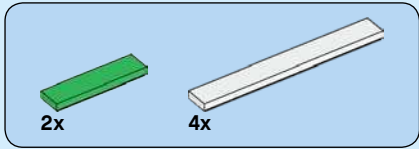

52

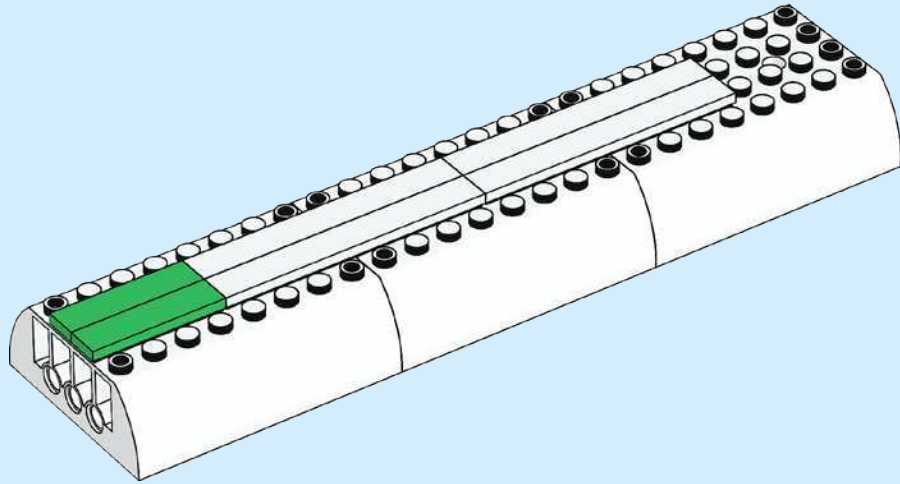

53

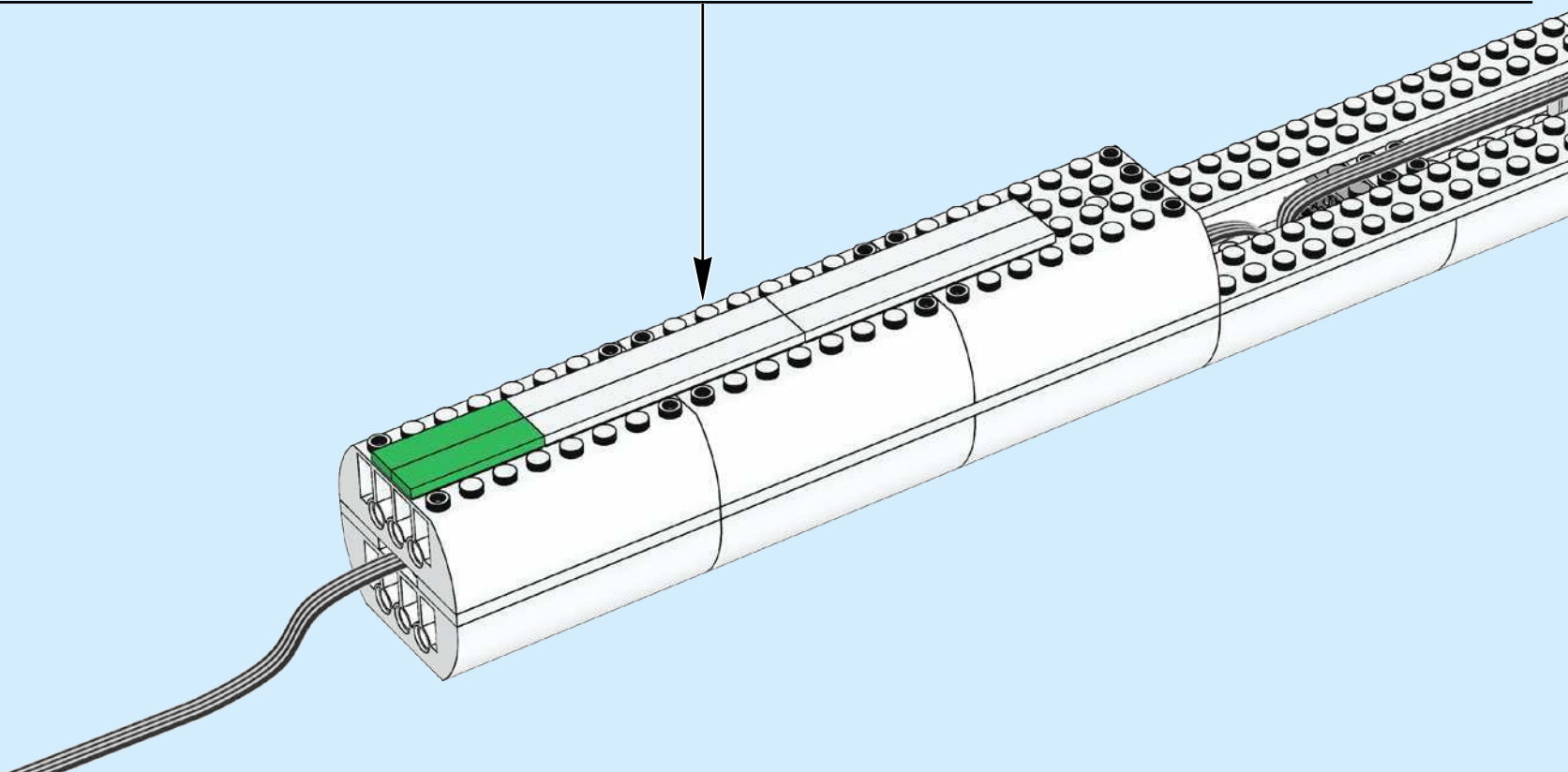

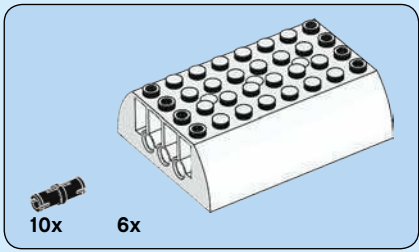

54

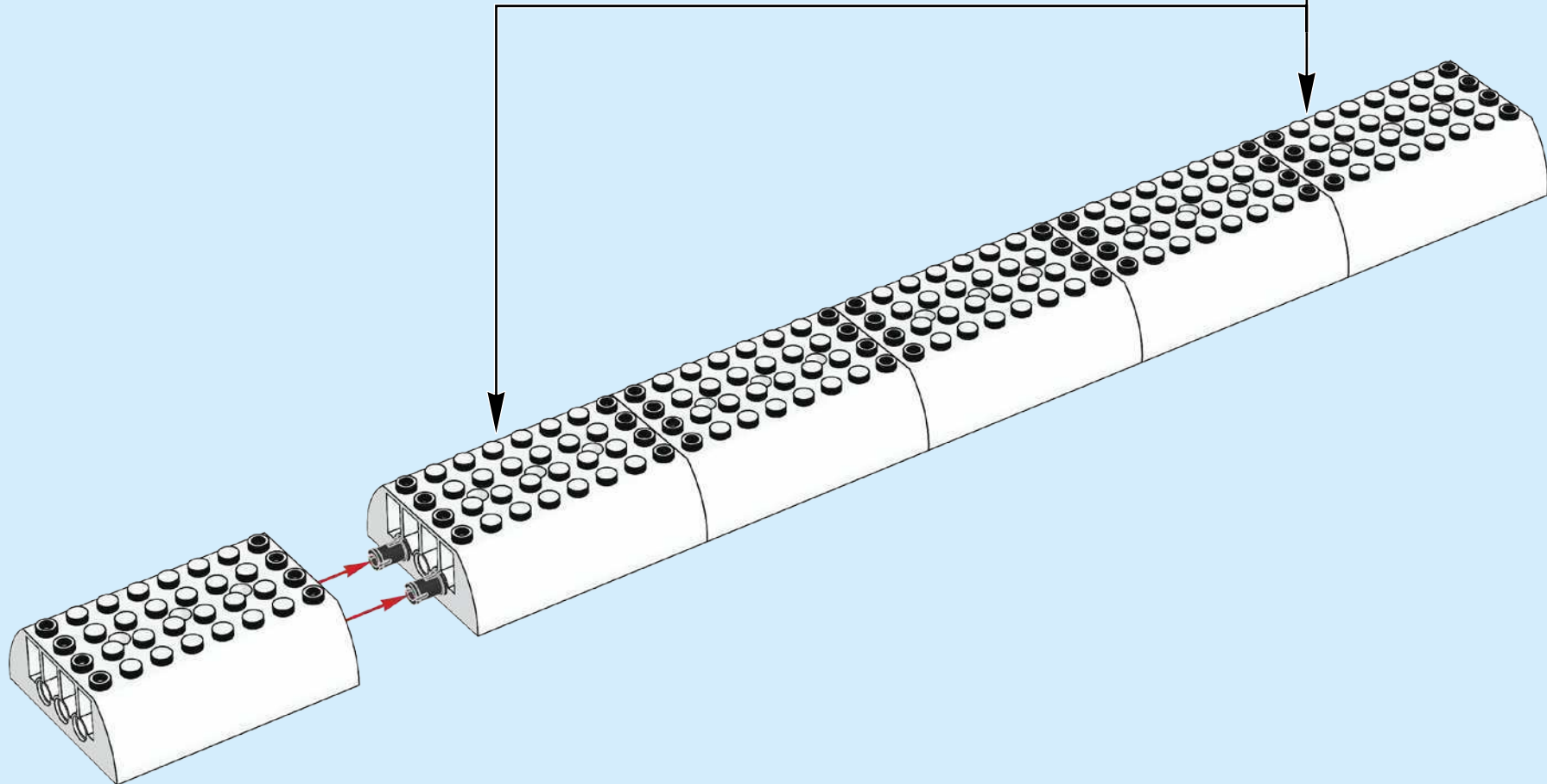
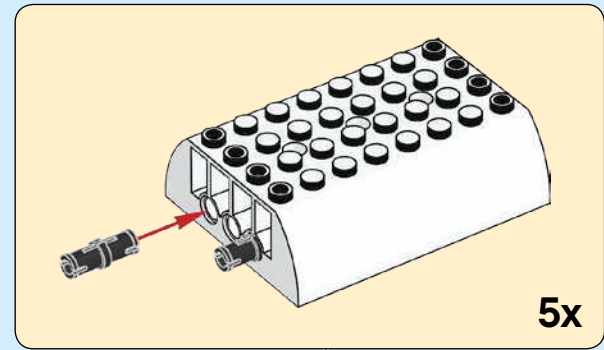

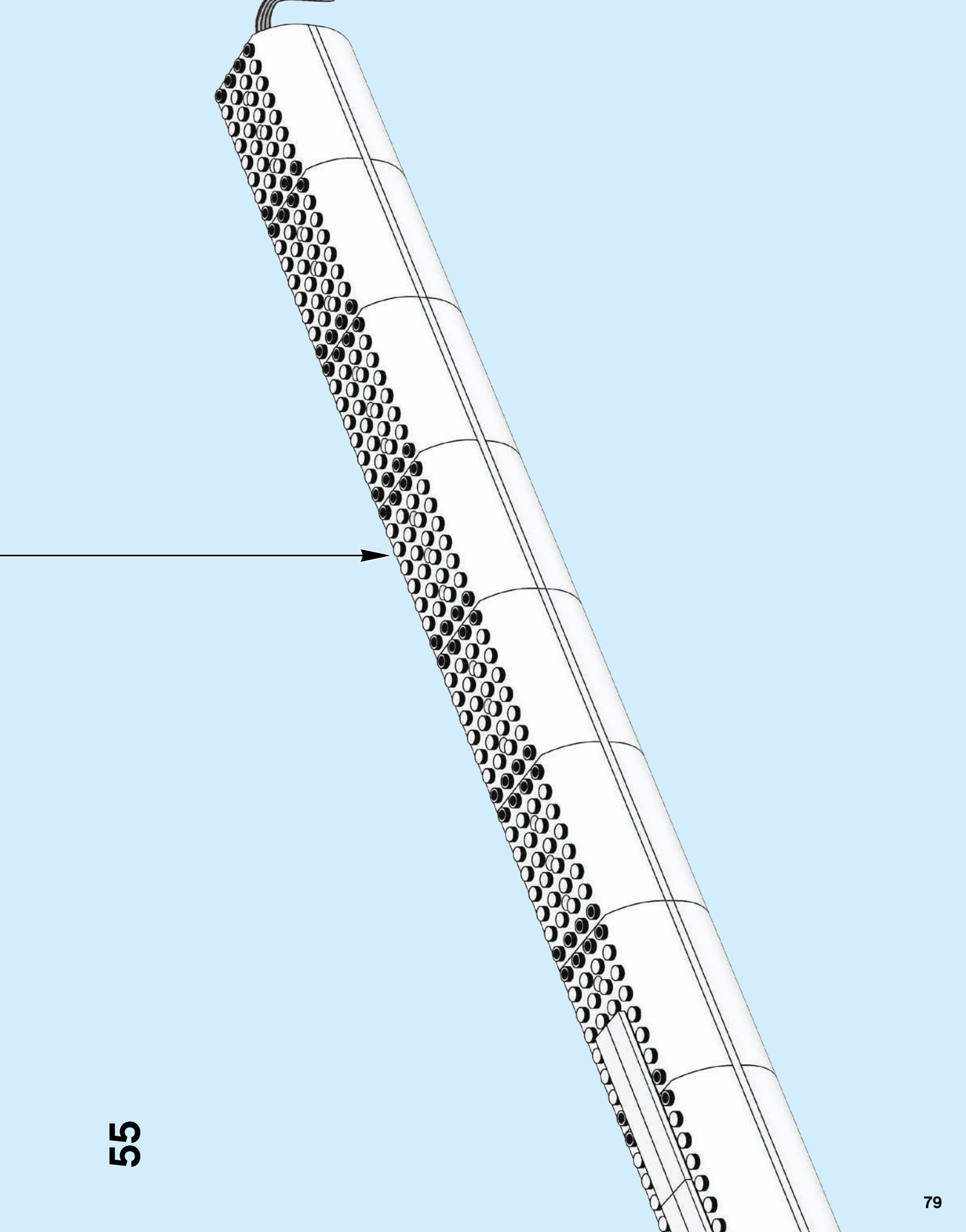

55

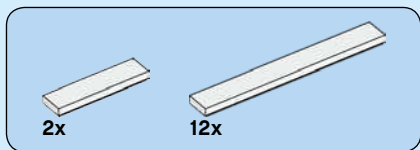
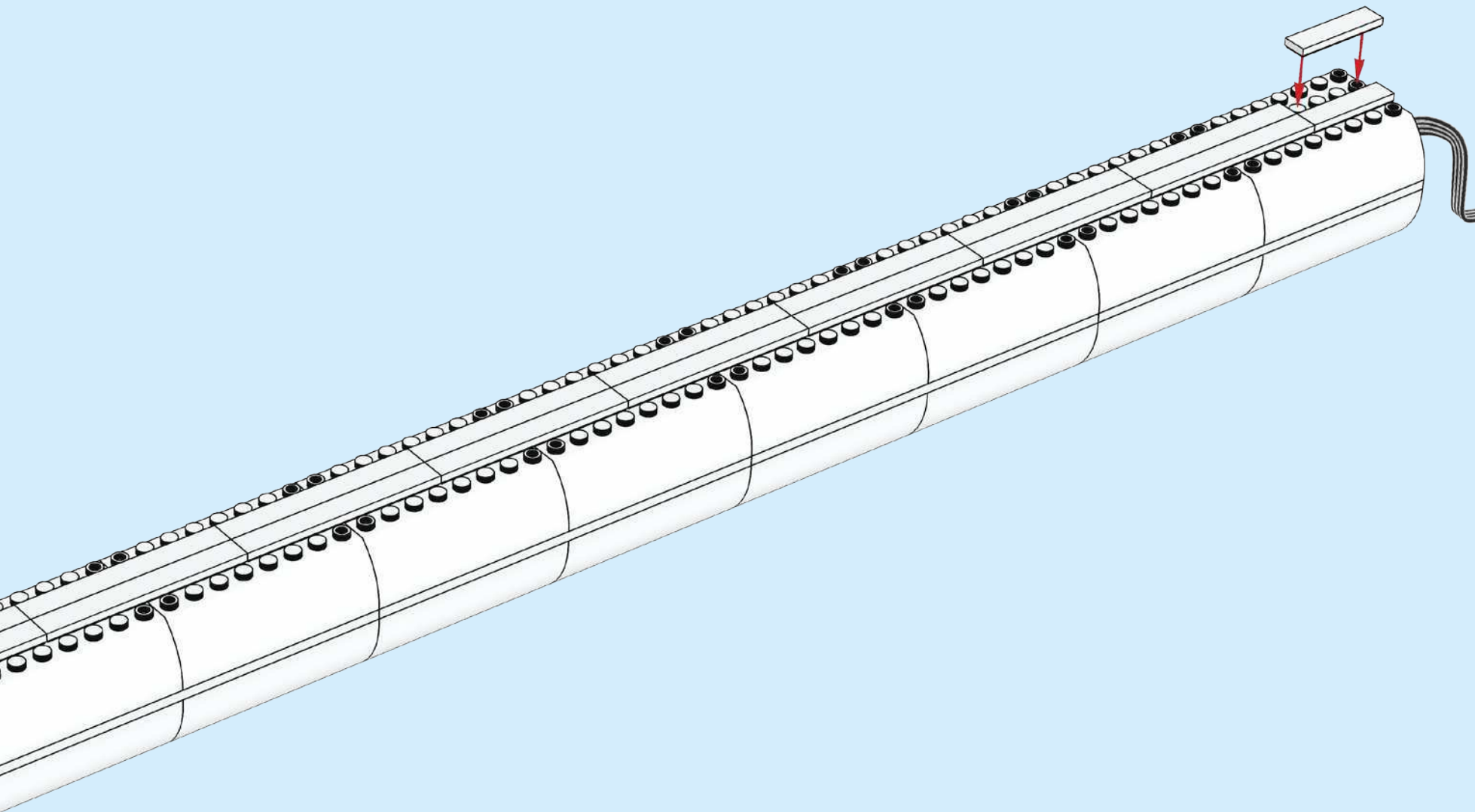
**56**

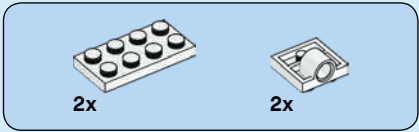

57

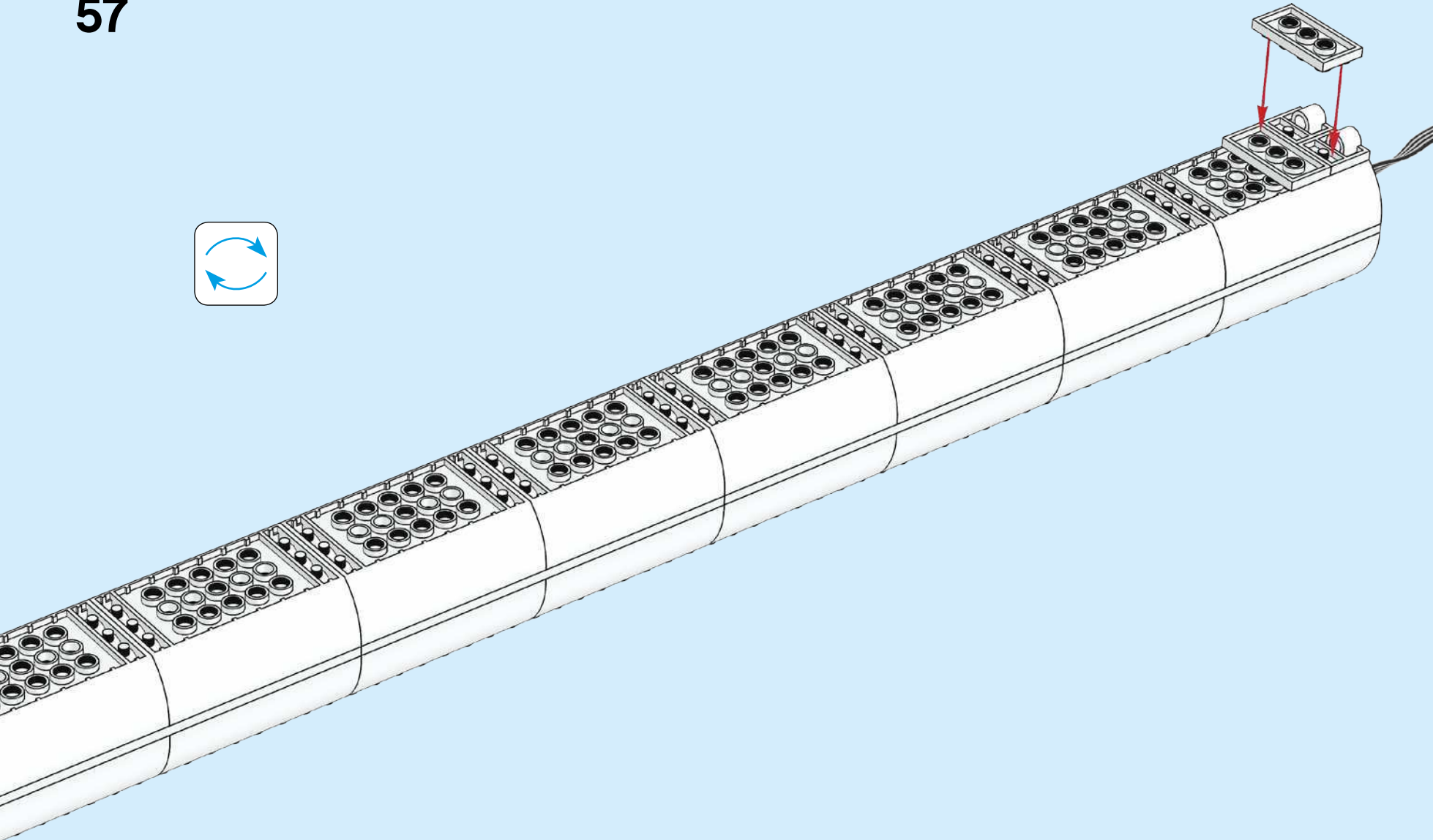
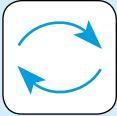

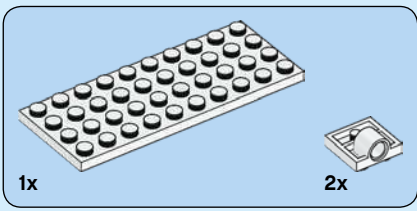

58

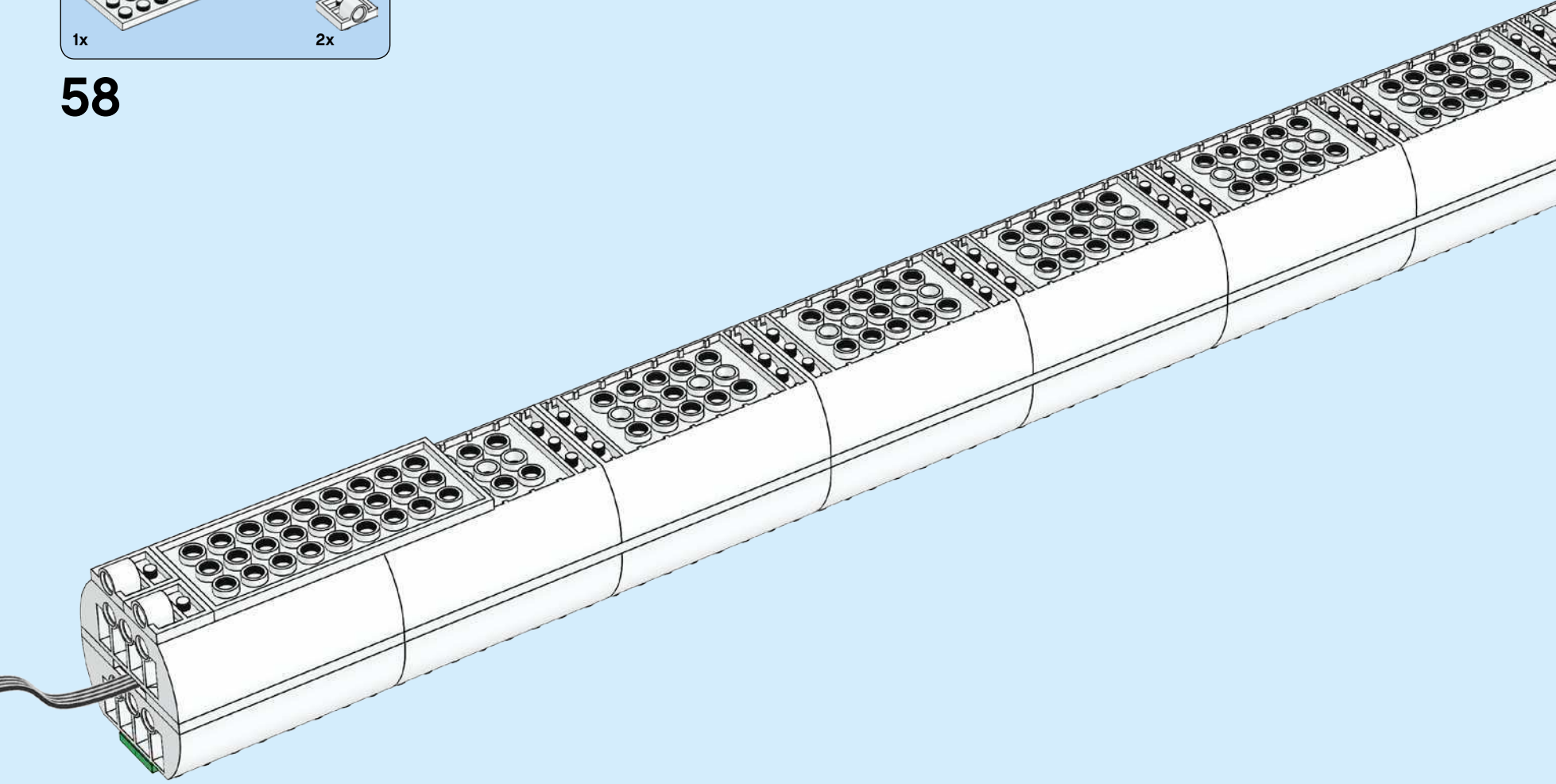

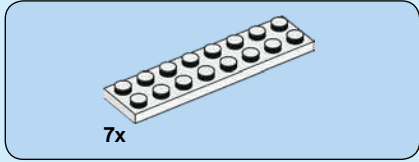

59

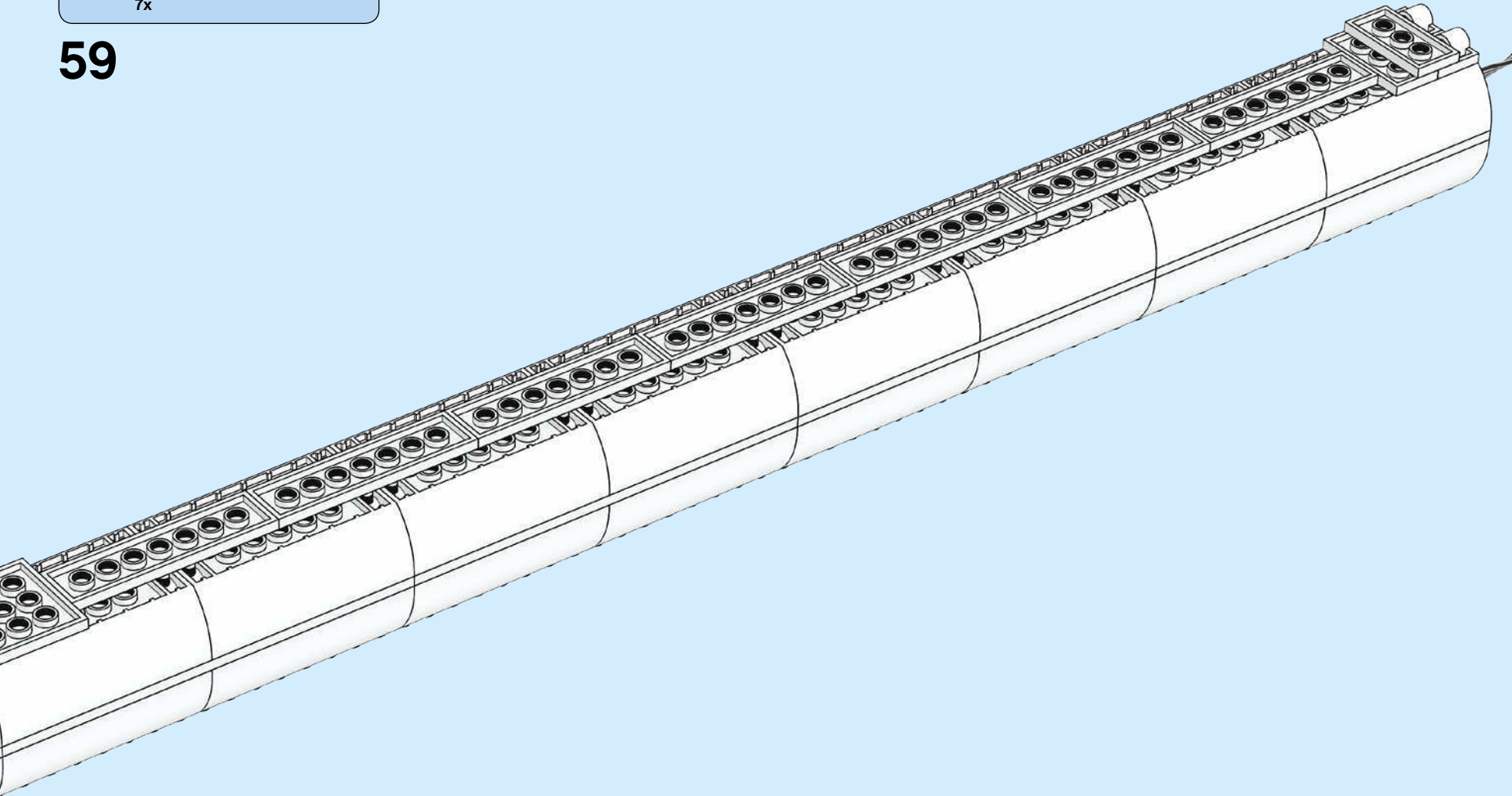

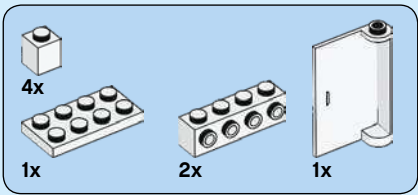

60

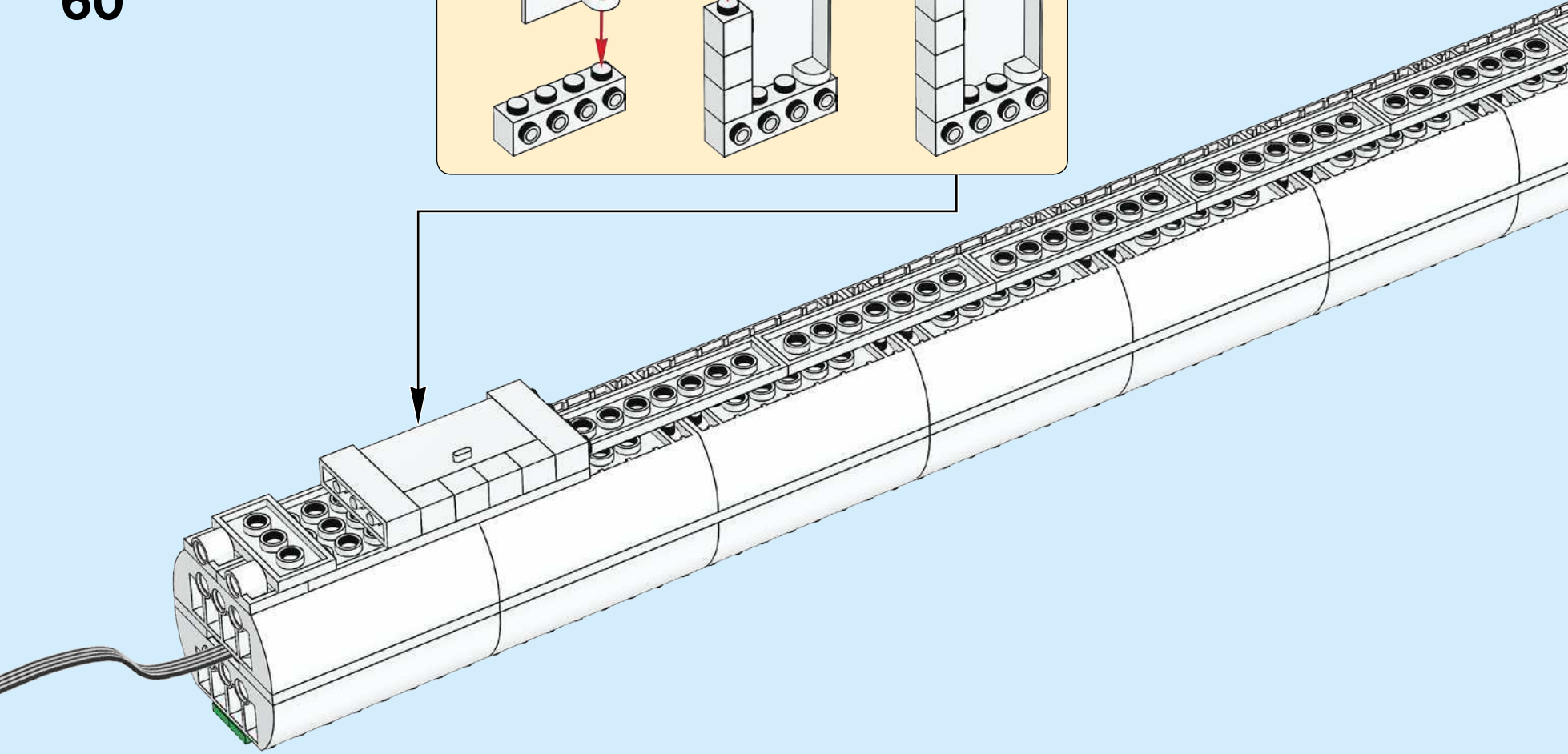
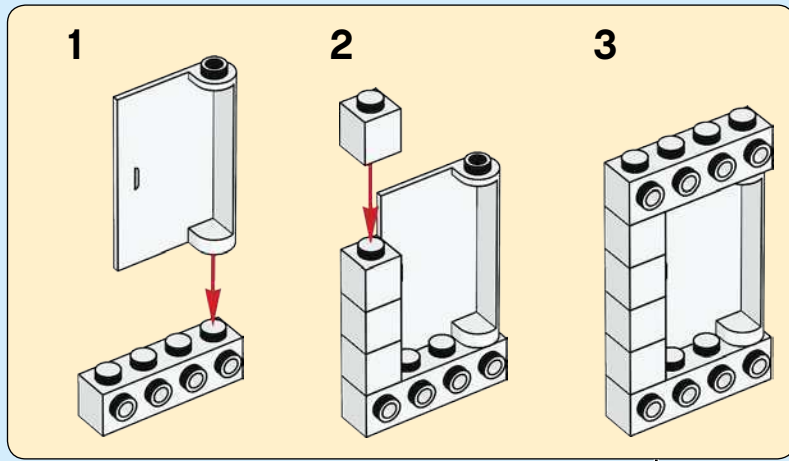

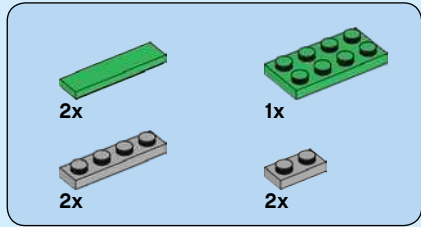

61

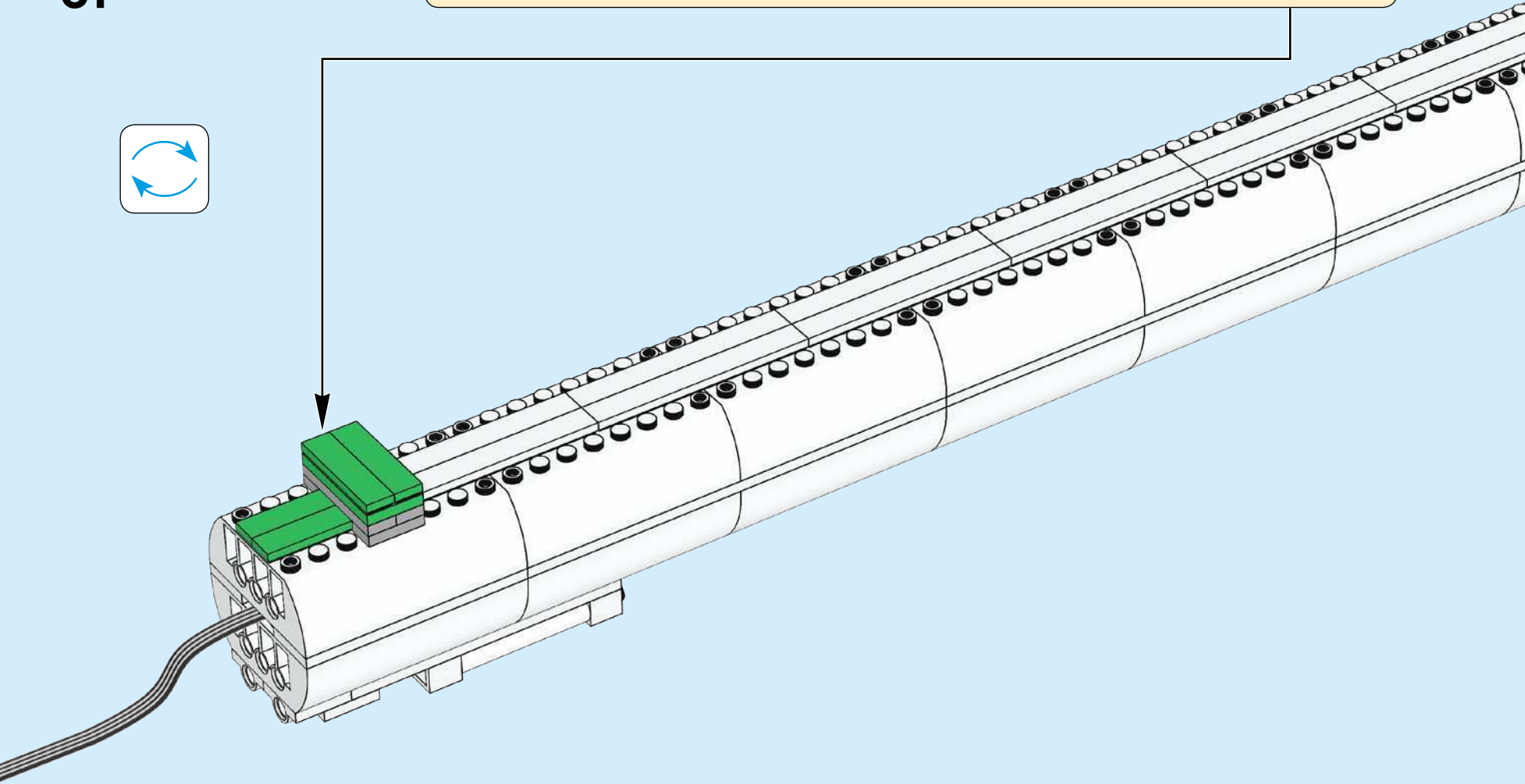
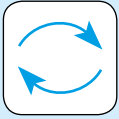
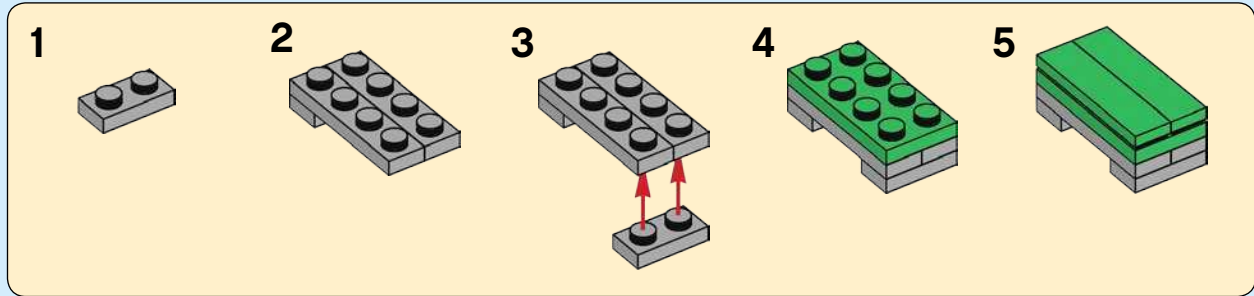

62

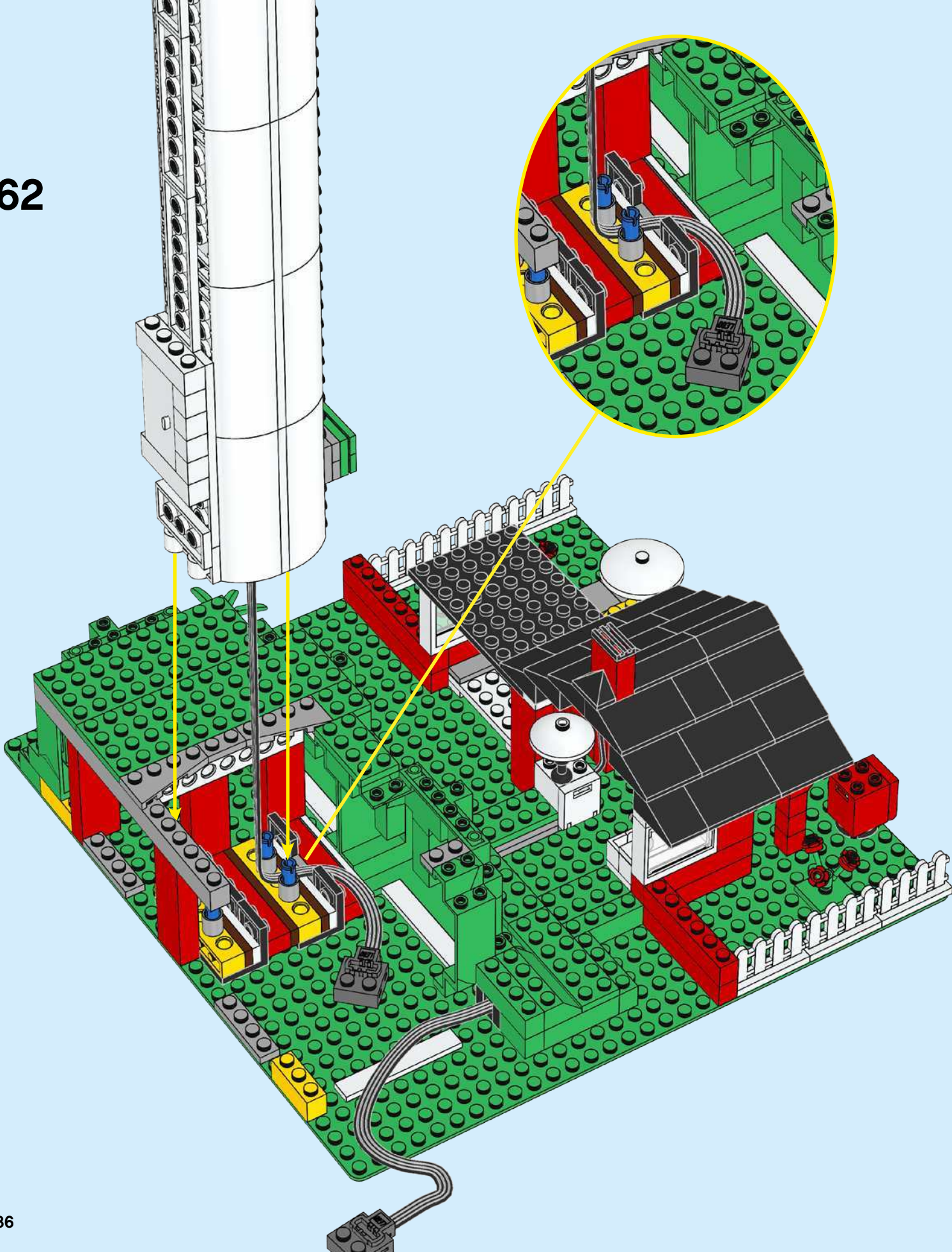

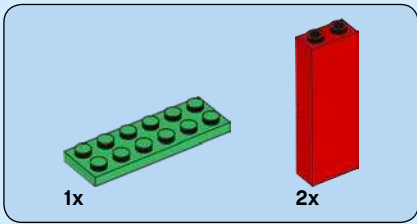

63

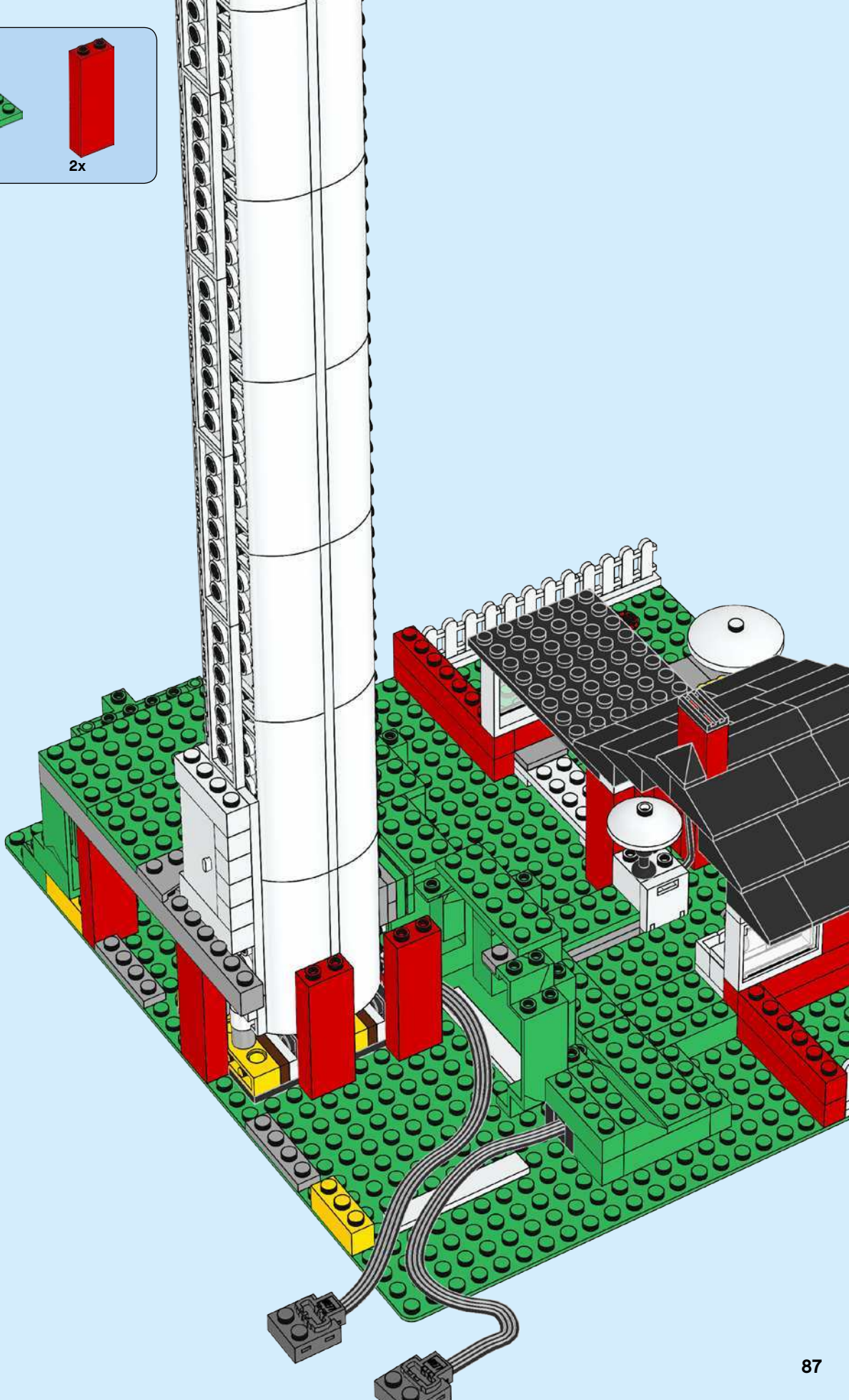

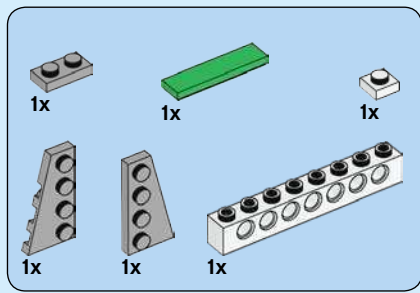

64

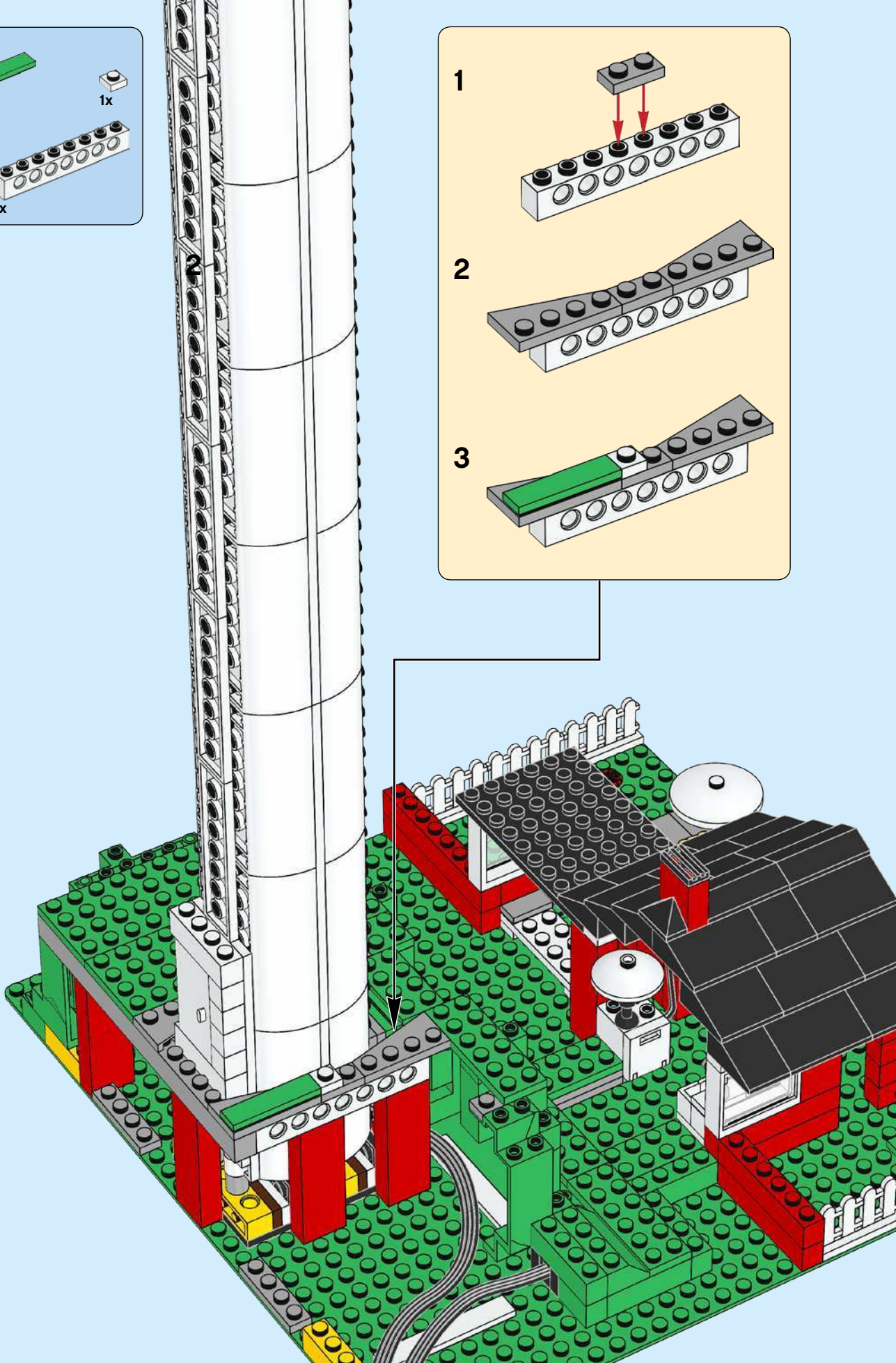
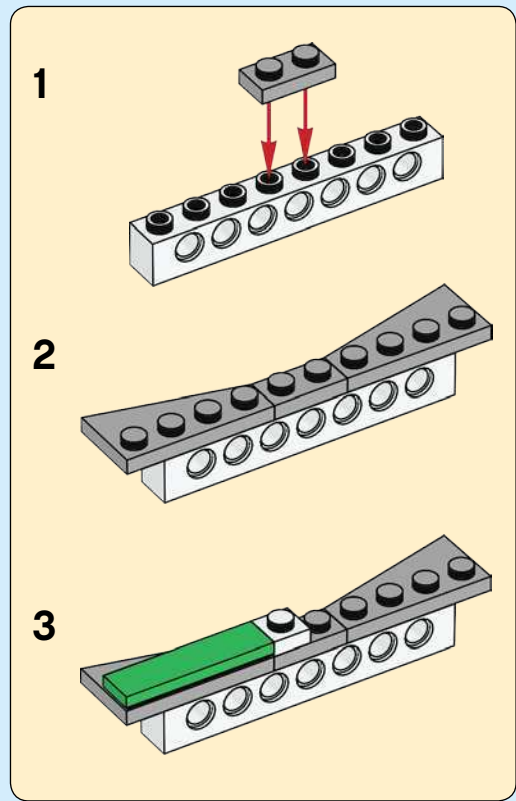

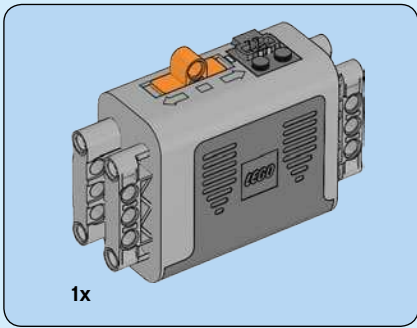

65

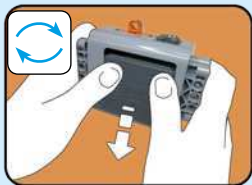
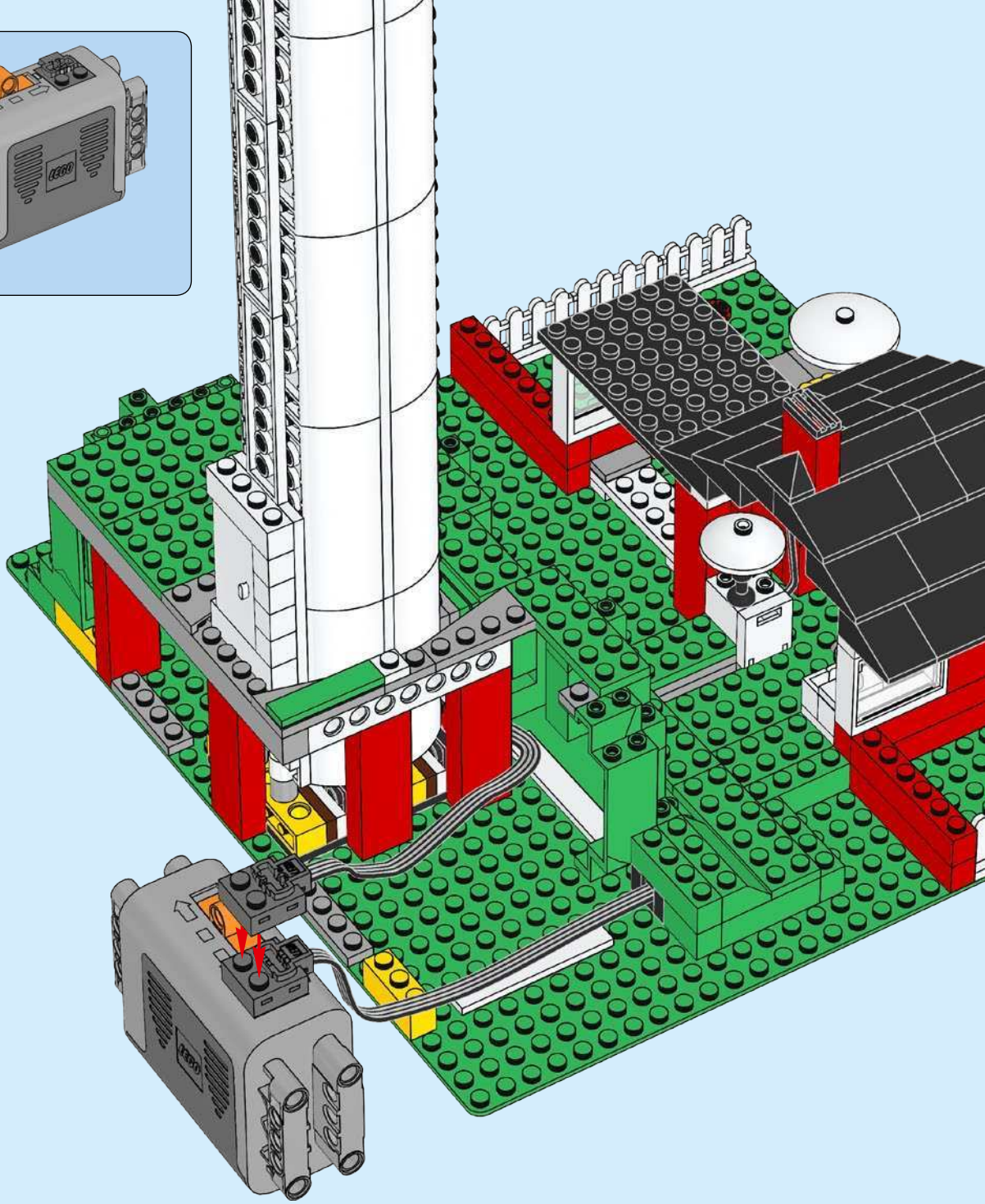

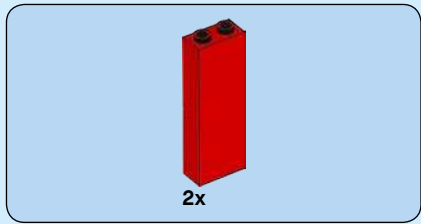

66

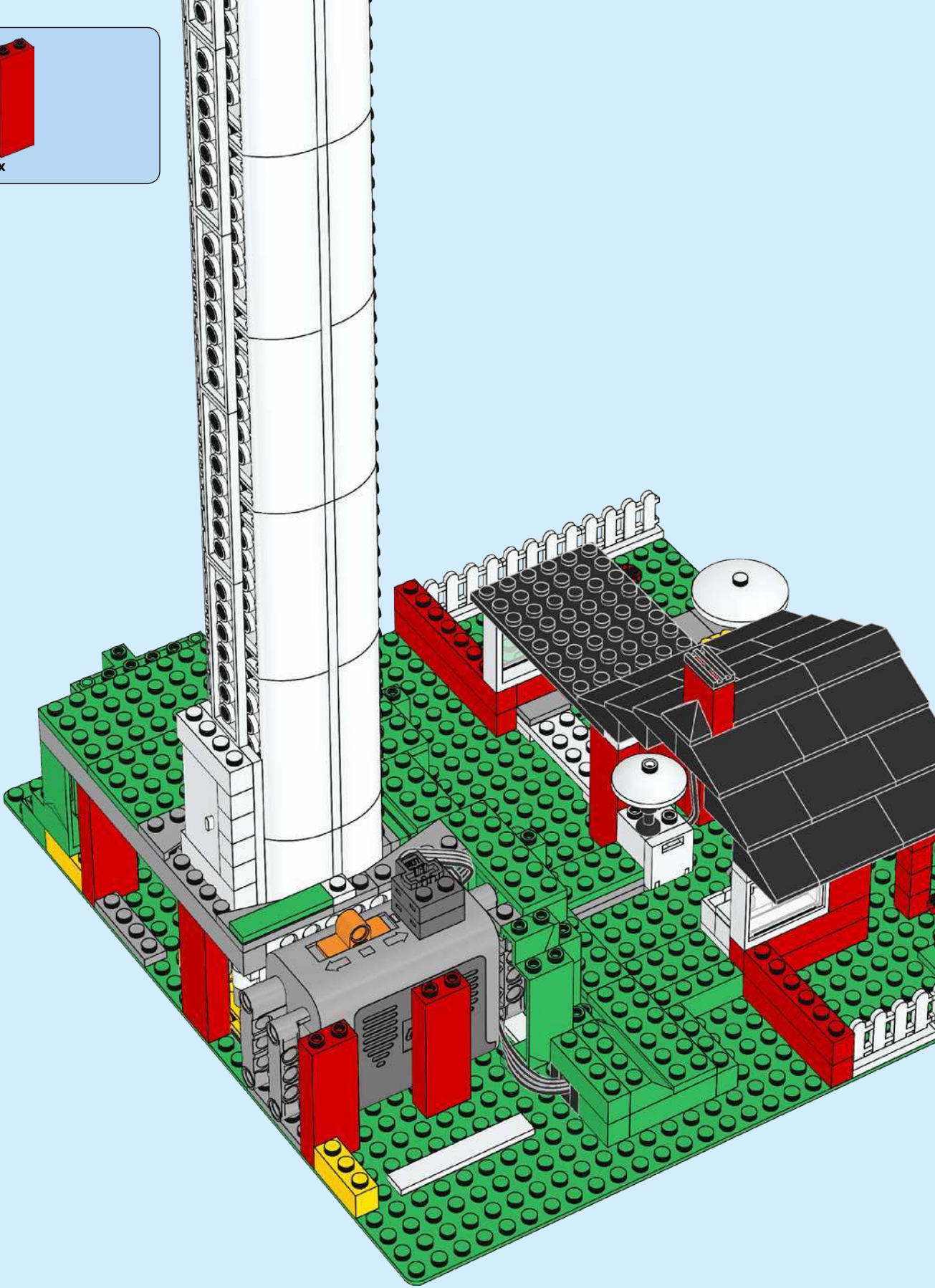

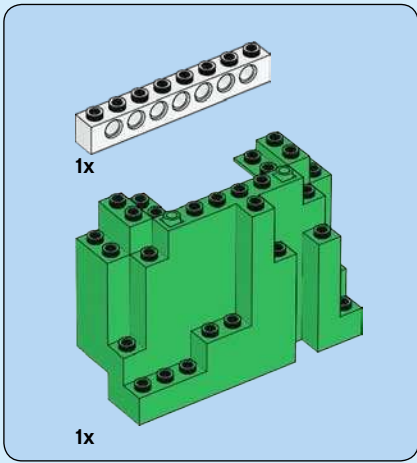

67

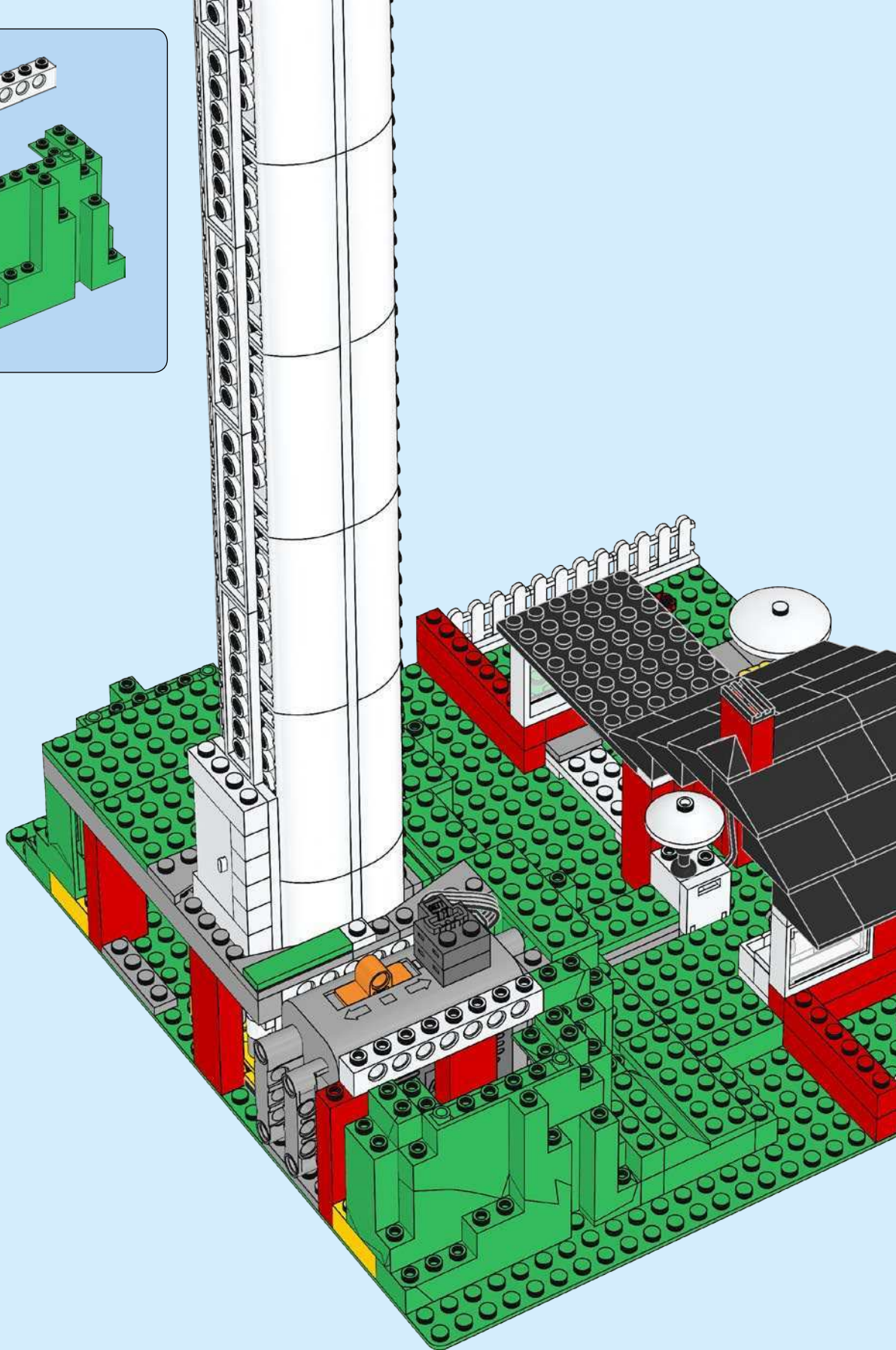

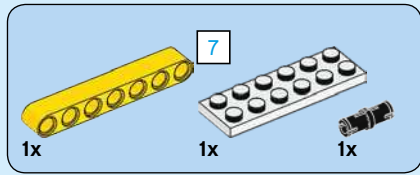

68

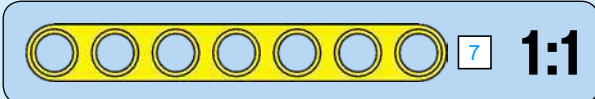
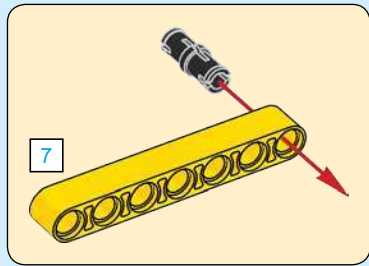
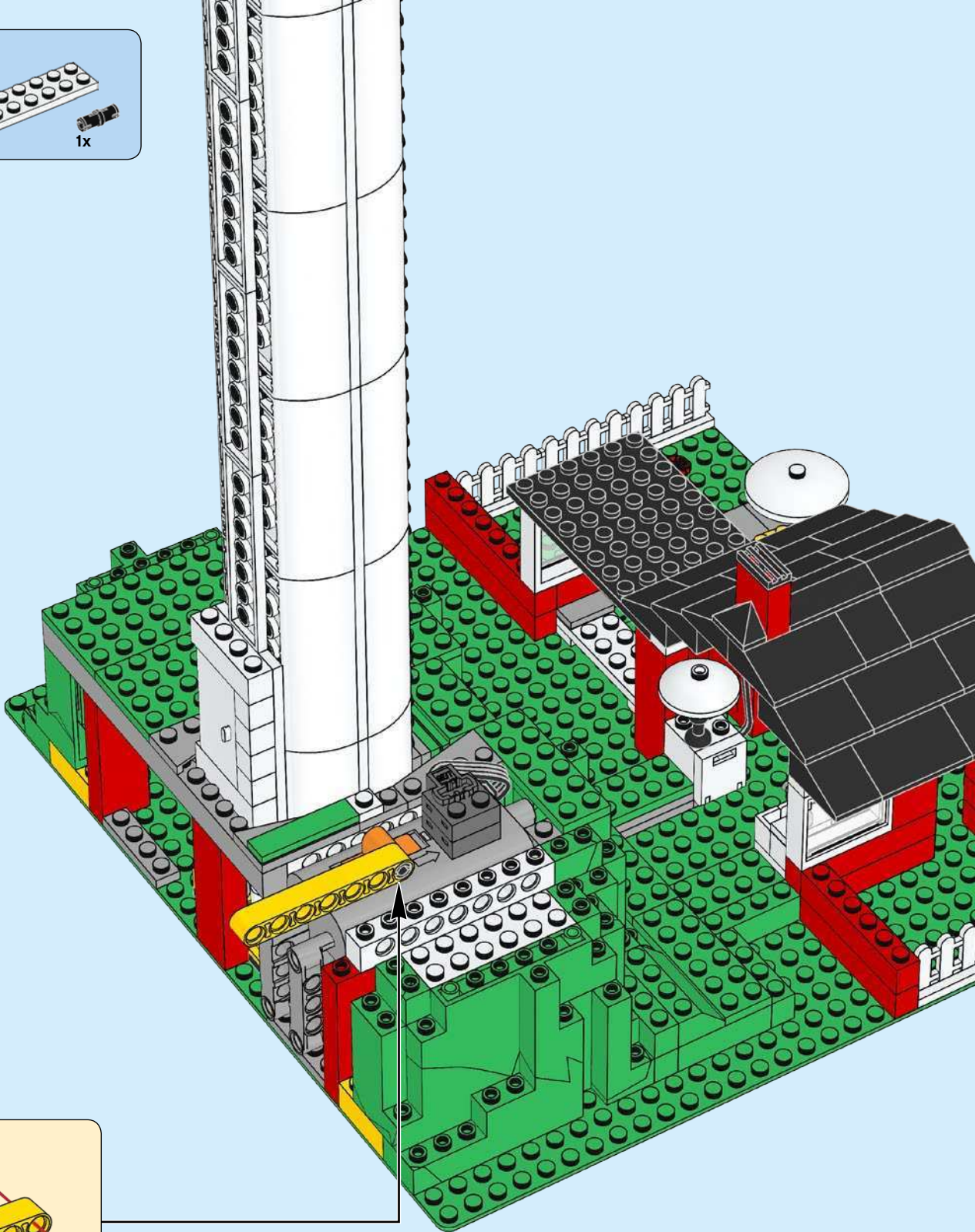

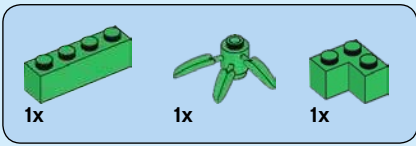

69

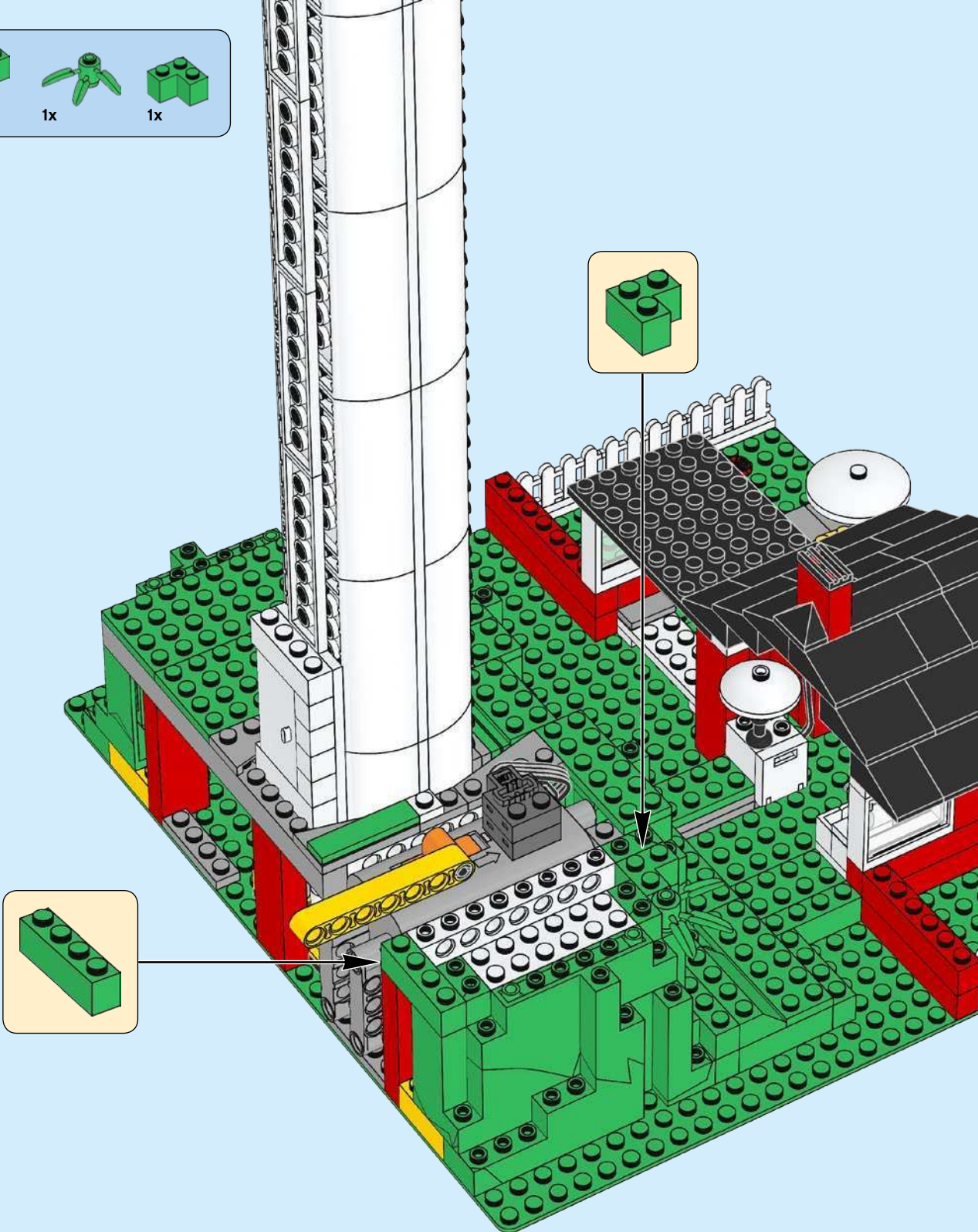

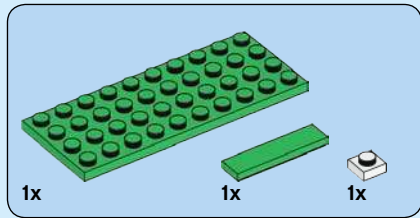

70

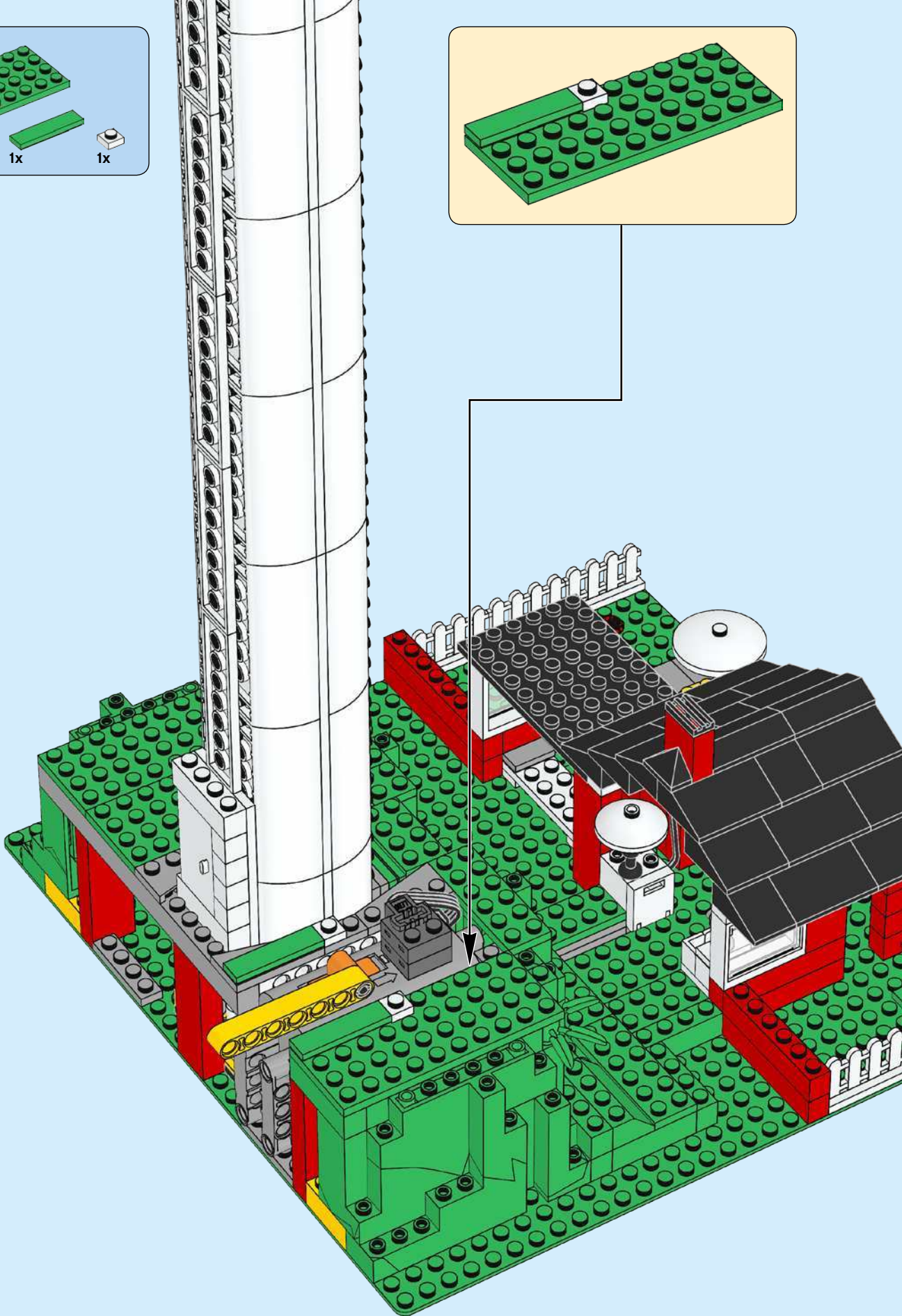
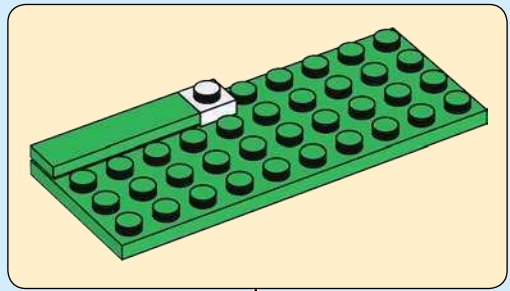

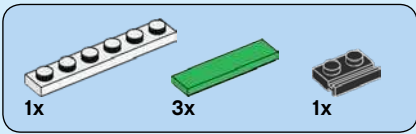

71

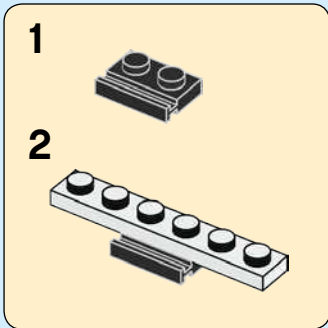
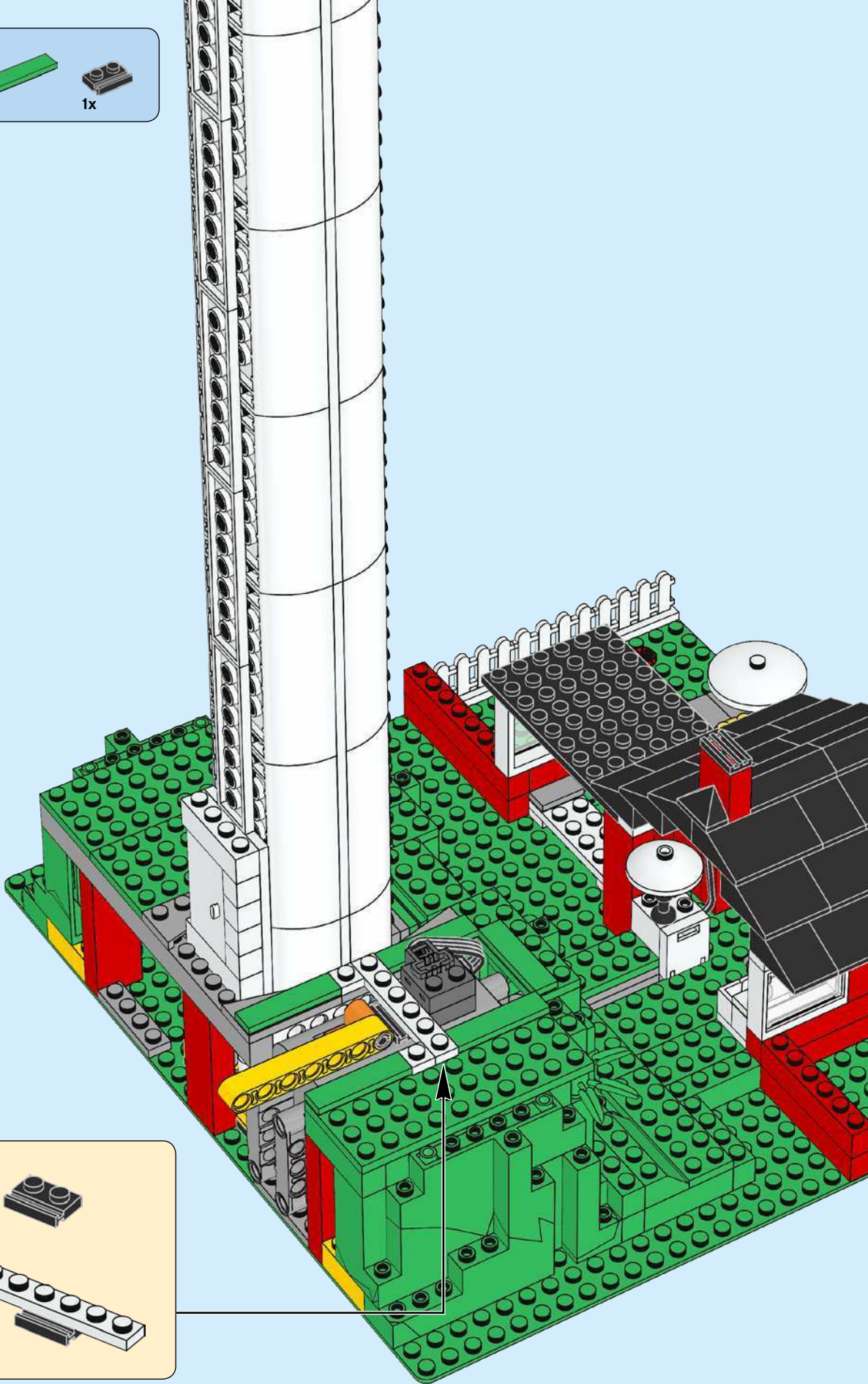

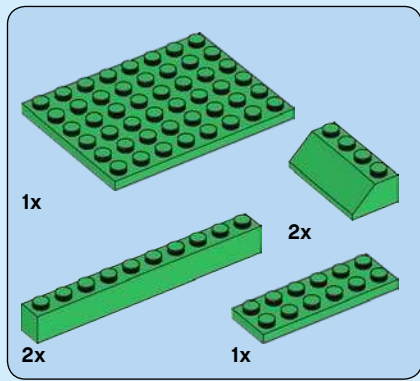

72

1

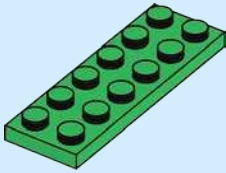

2

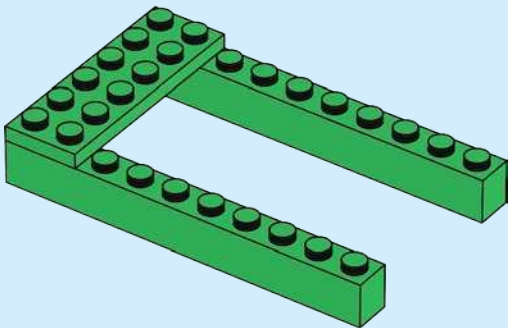

3

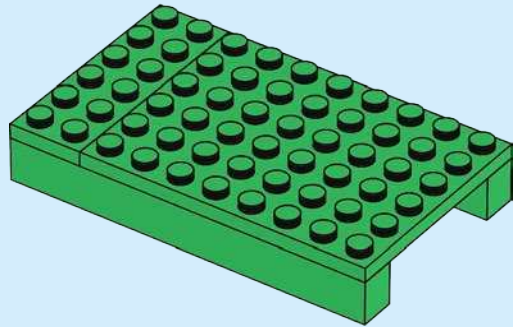

4

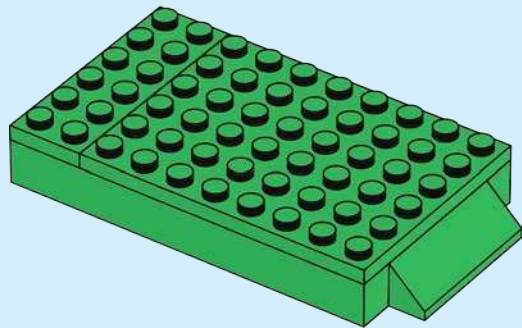

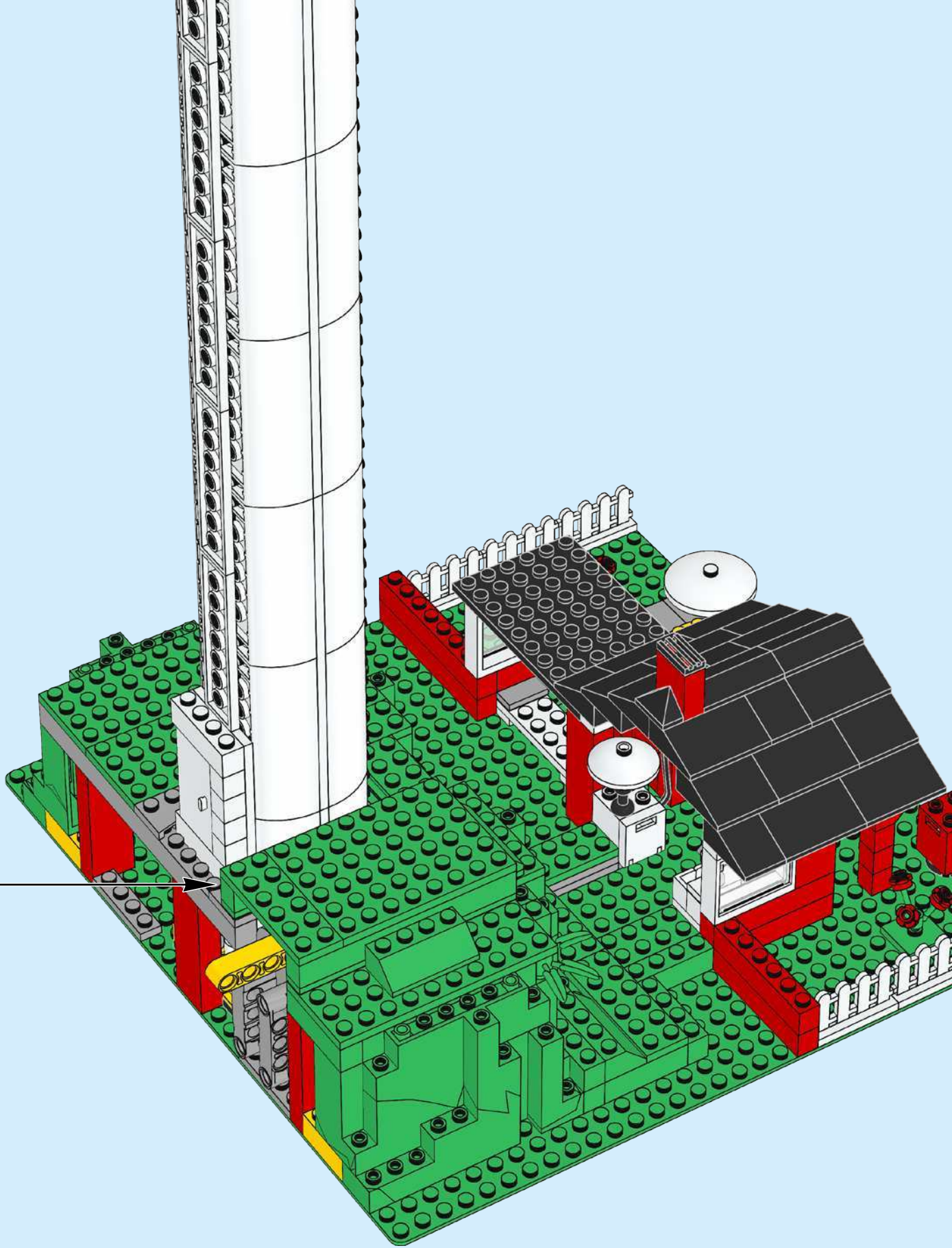

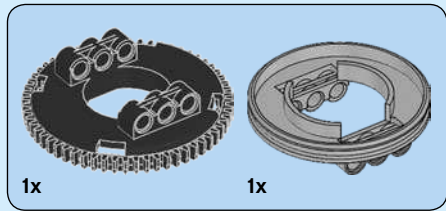

73

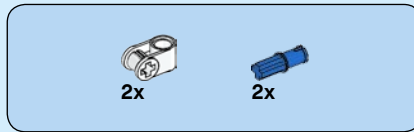
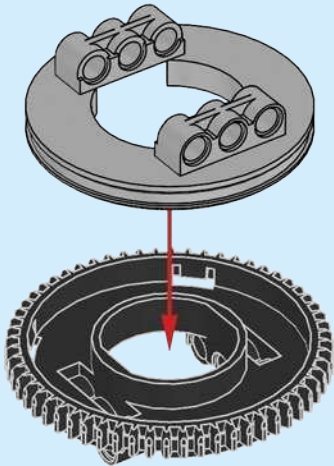

74

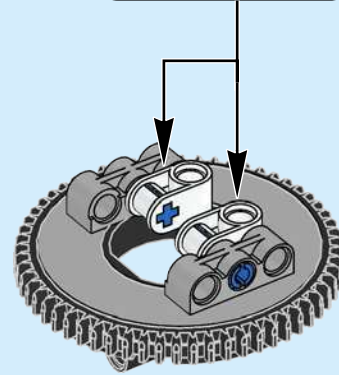
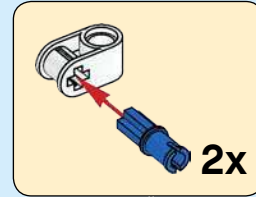

75

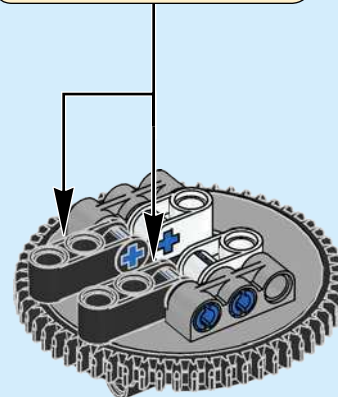
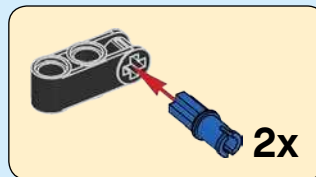



76

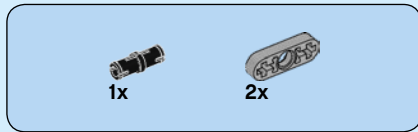
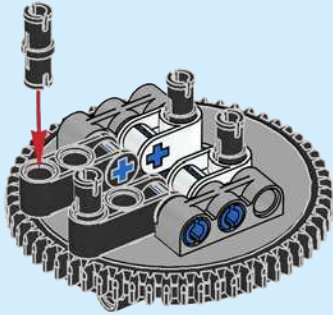

77

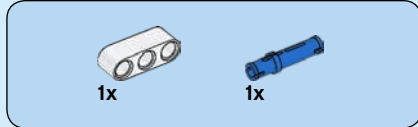
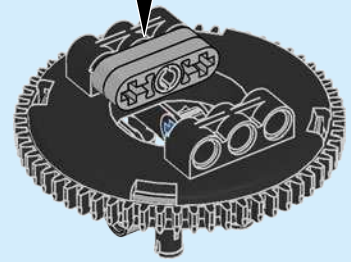
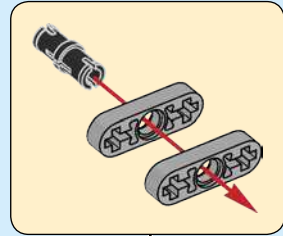
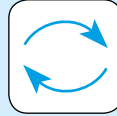

78

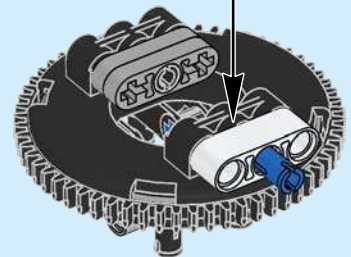
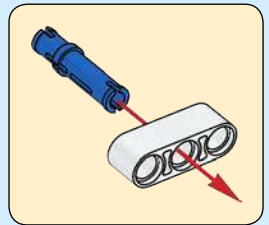

79

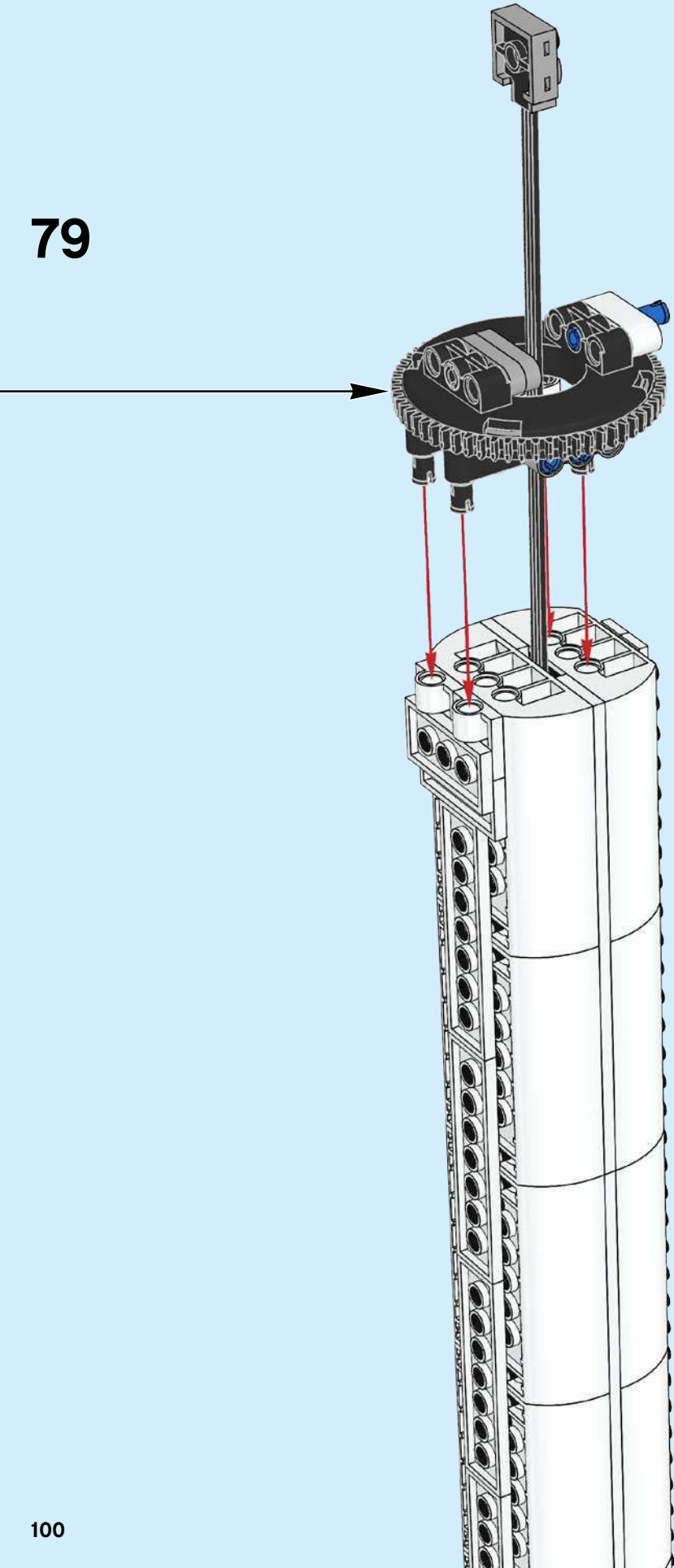

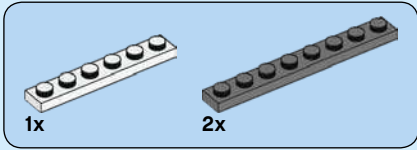
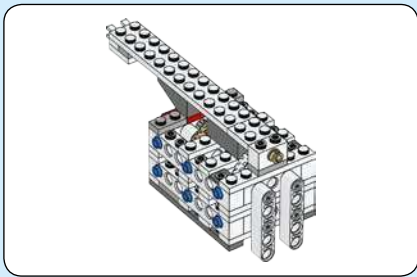

80

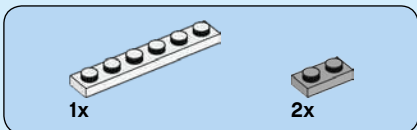
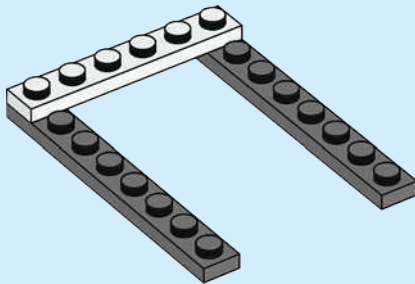

81

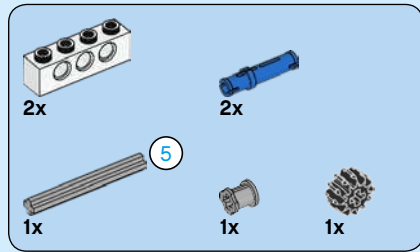
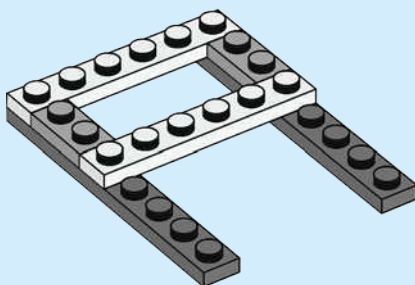

82

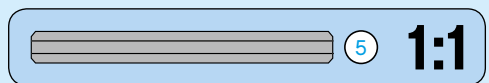
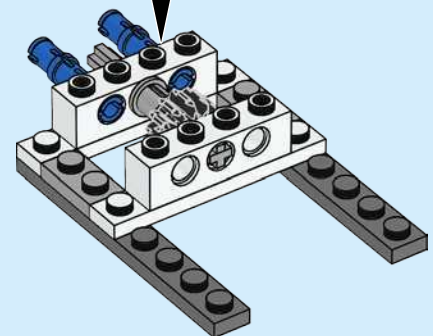
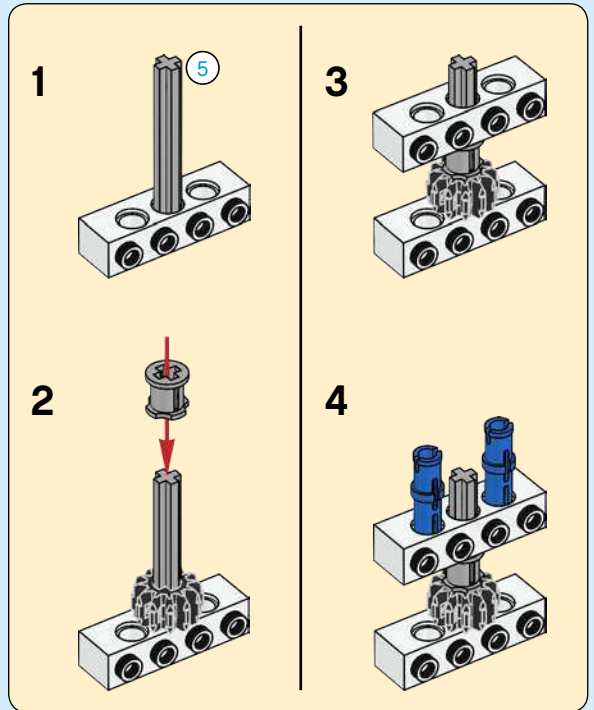

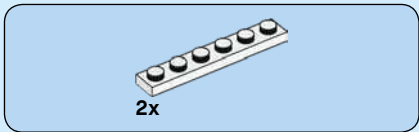

83

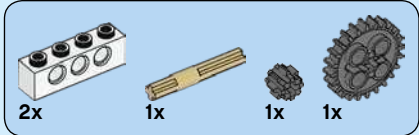
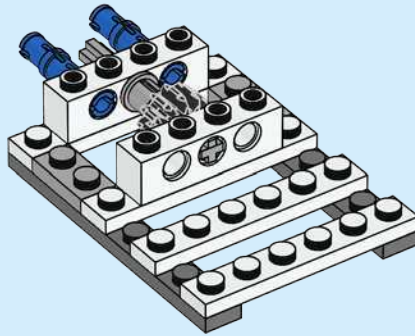

84

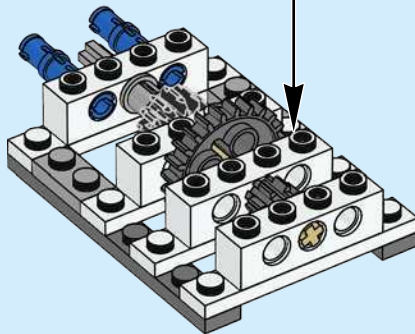
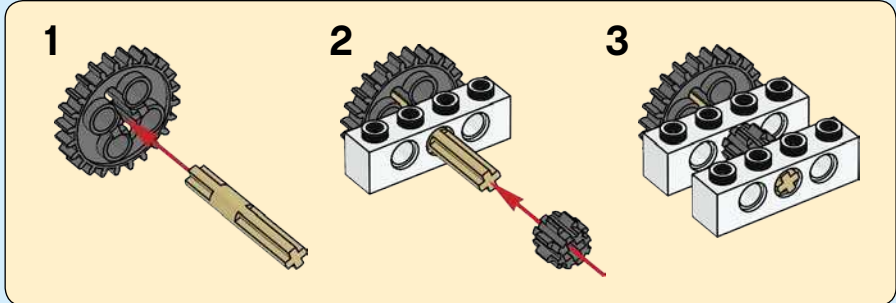

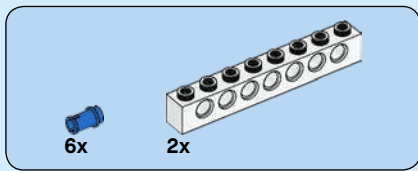

85

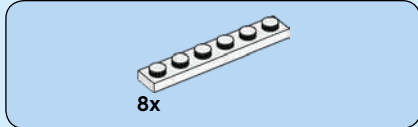
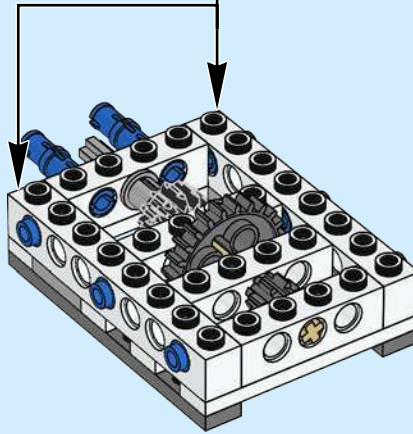
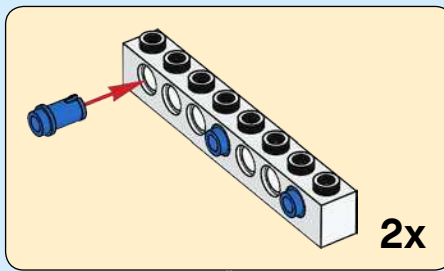

86

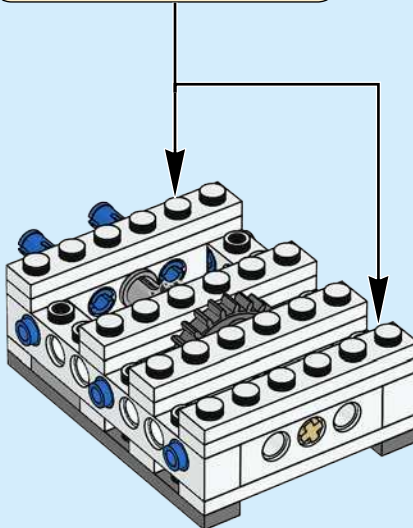
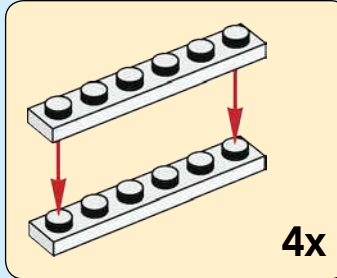

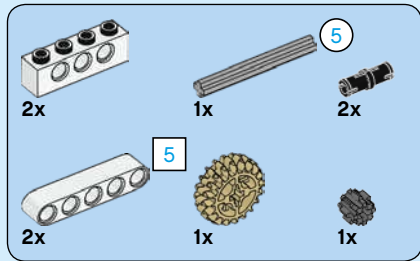

87

1

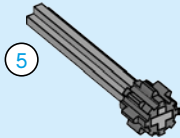

2

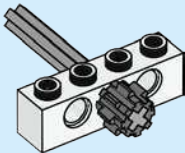

3

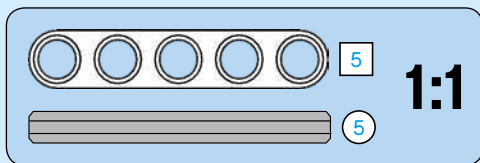
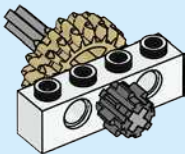

4

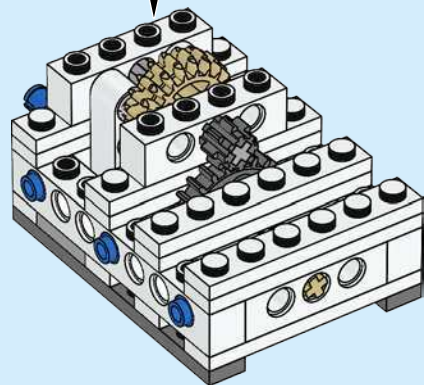
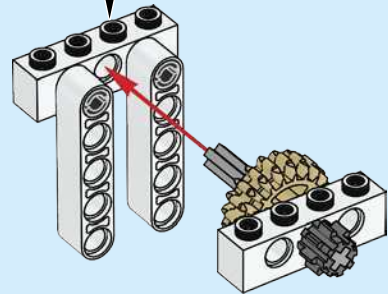
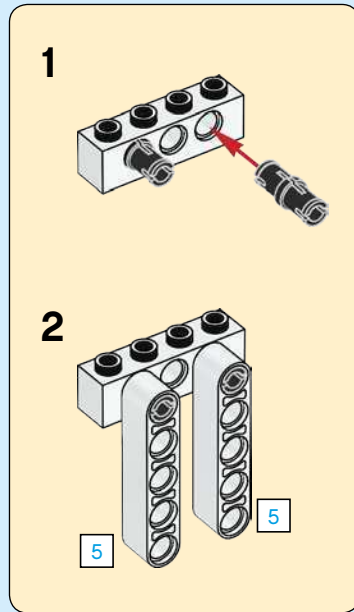

88

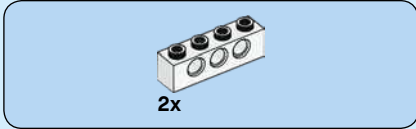
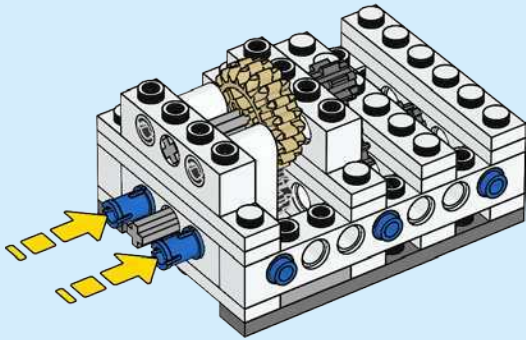

89

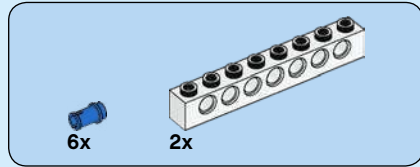
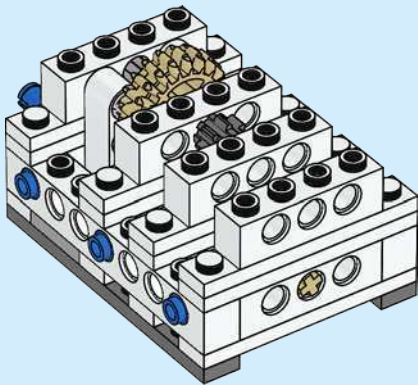

90

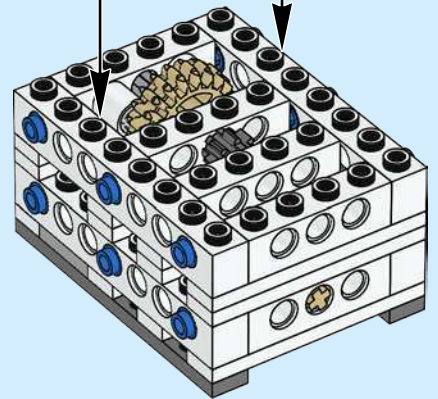
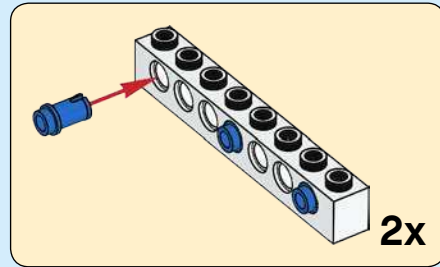

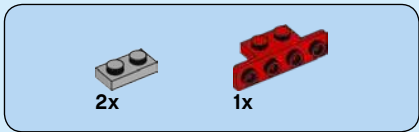

91

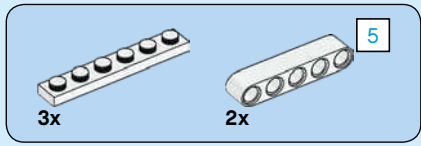
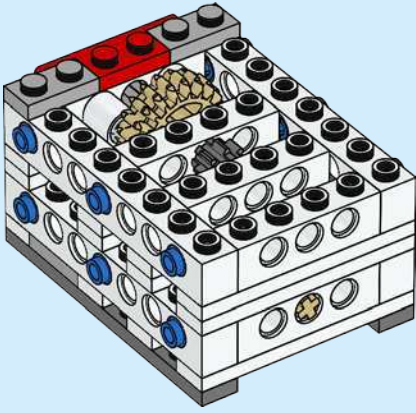

93

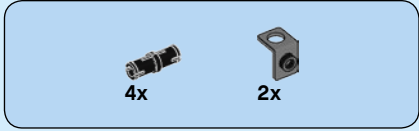
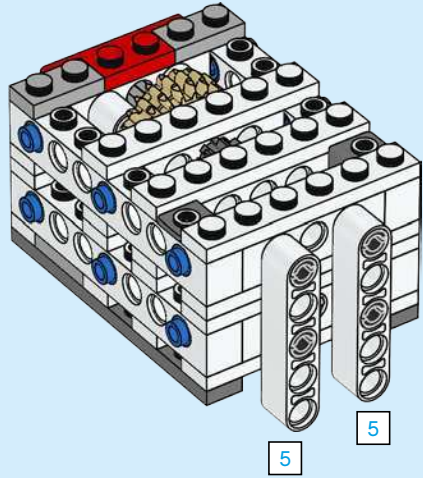

92

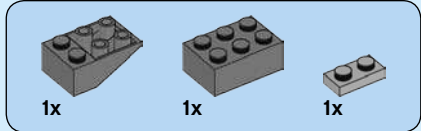
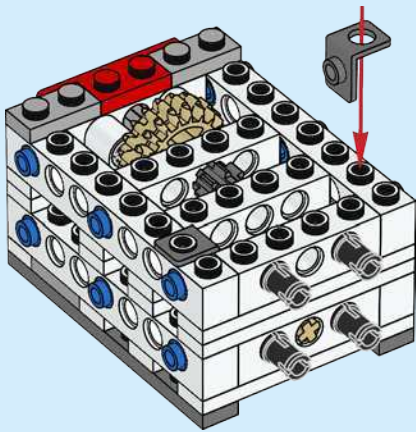

94

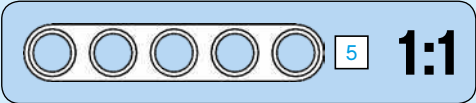
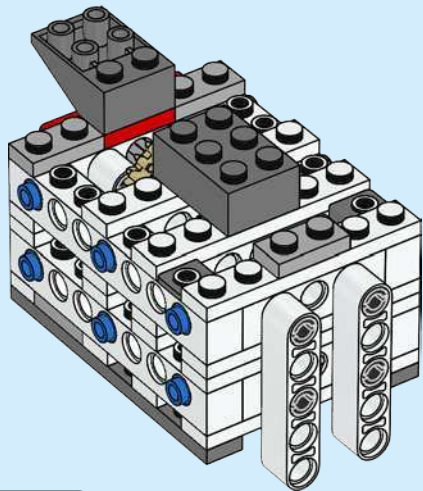

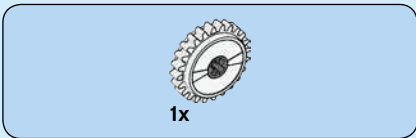

95

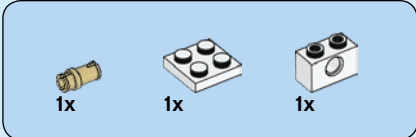
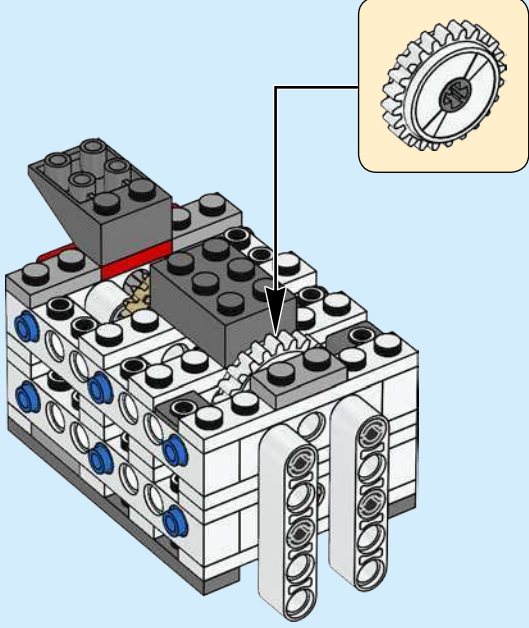

96

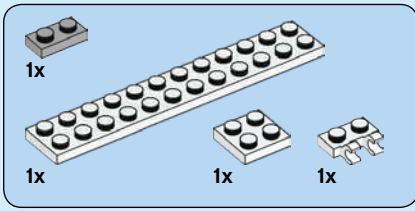
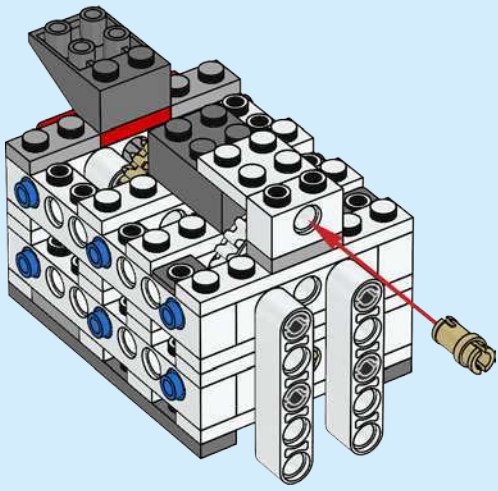

97

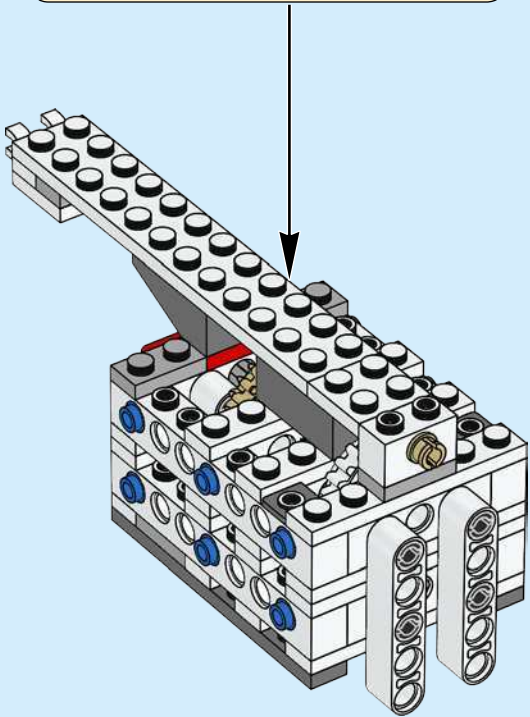
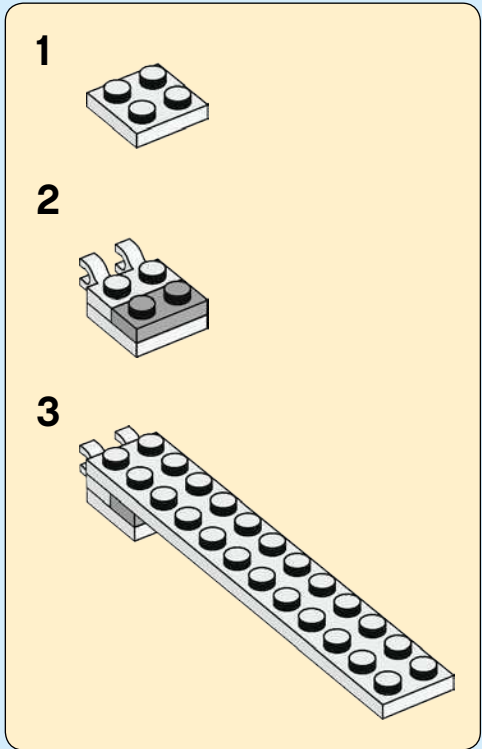

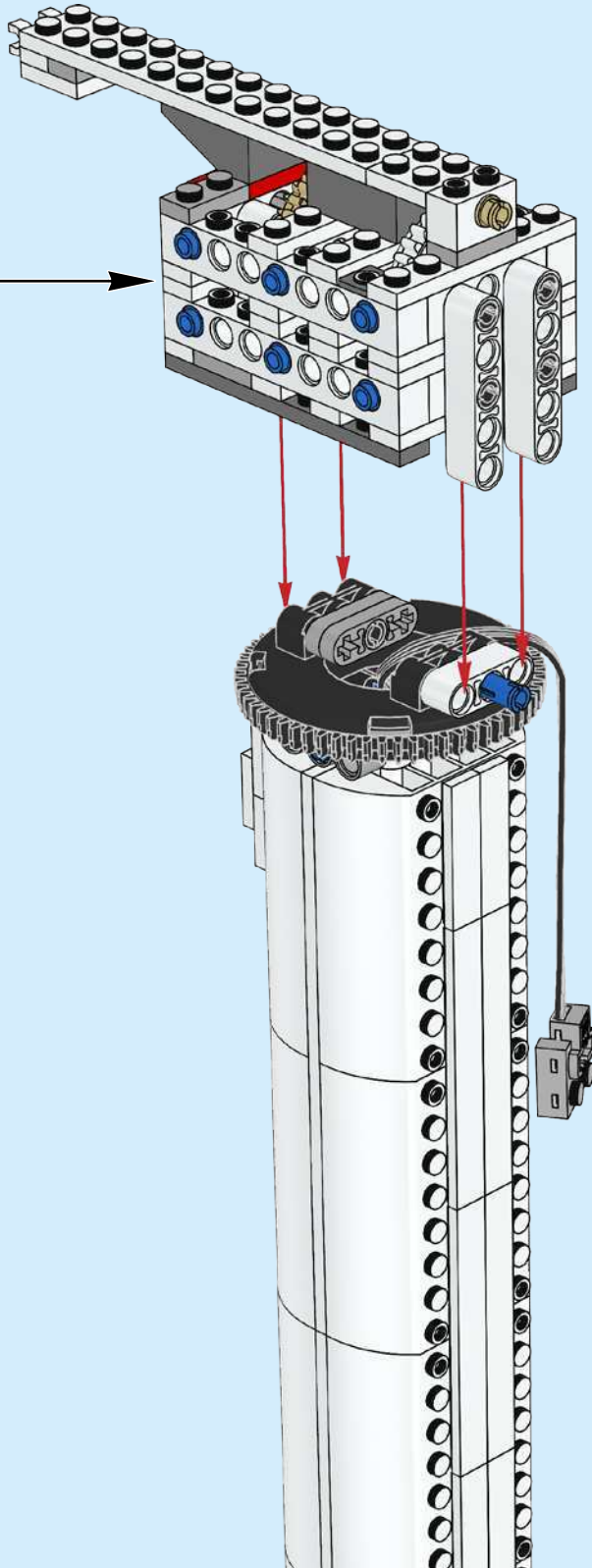
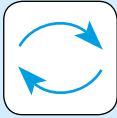

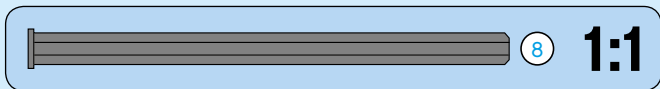
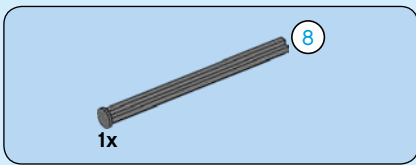

99

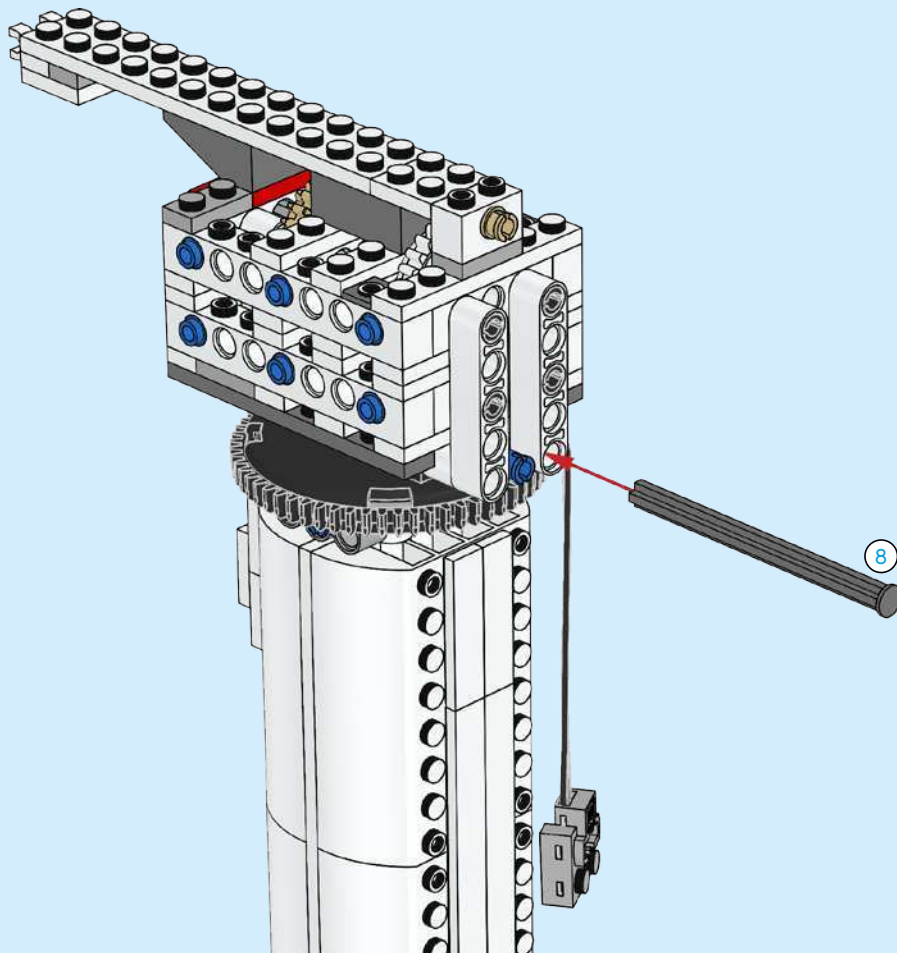
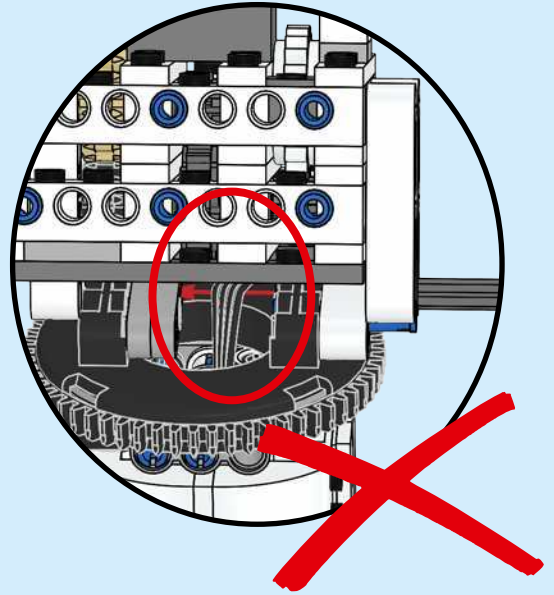
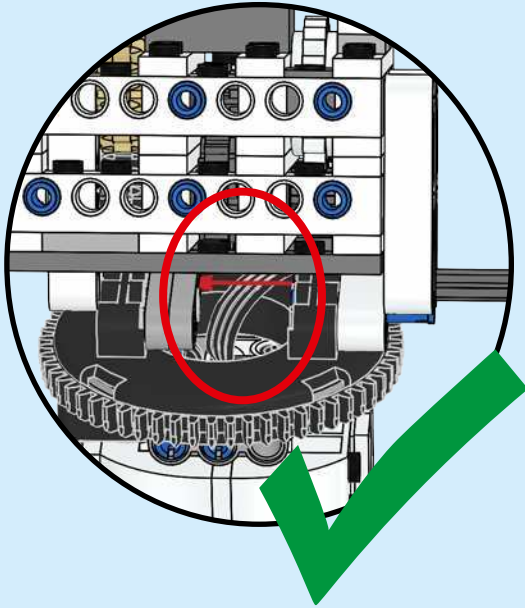

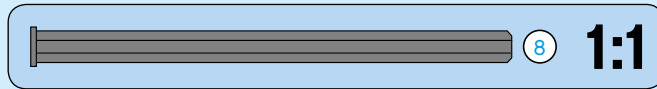
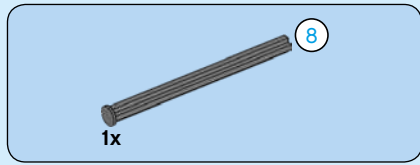

100

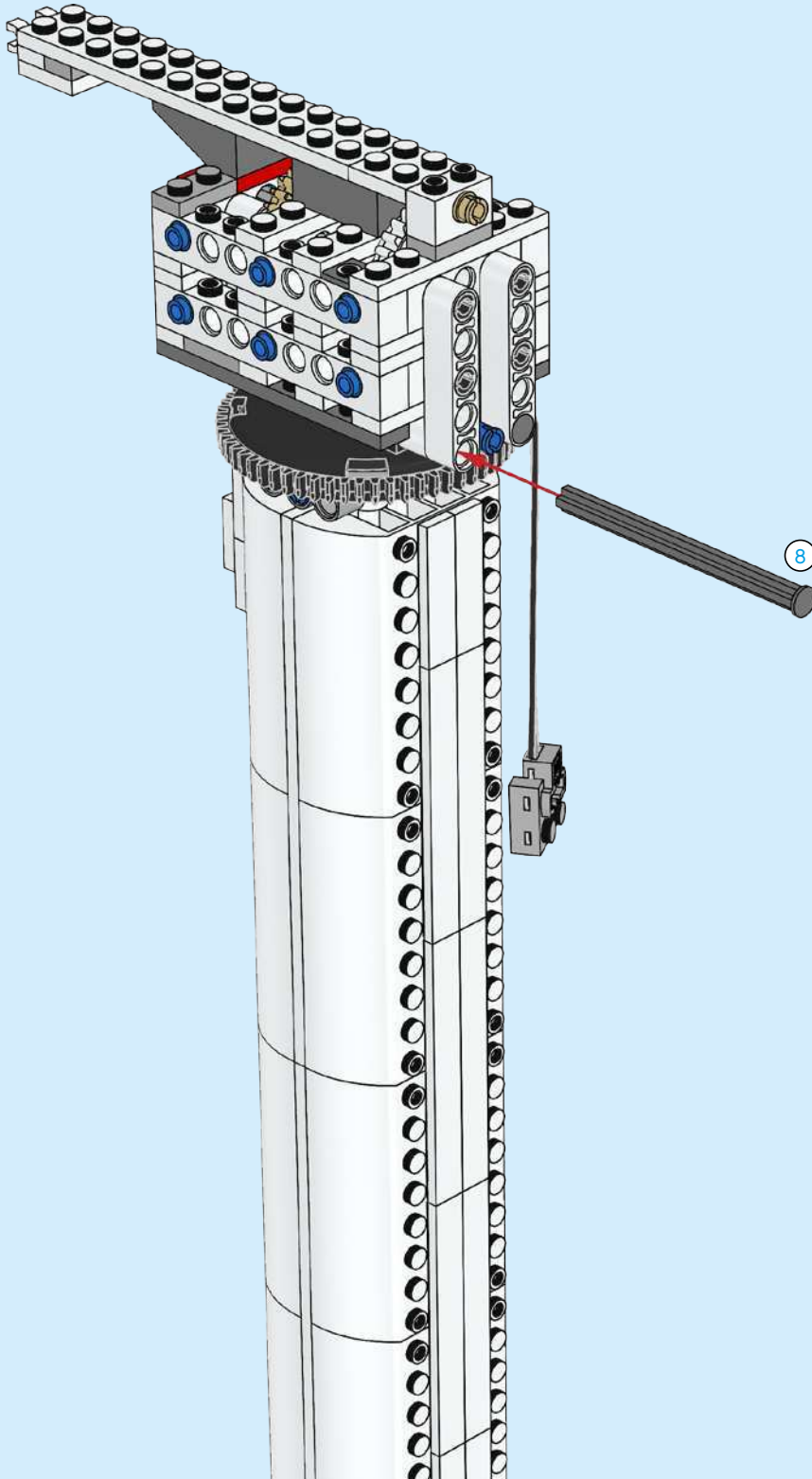

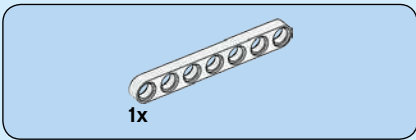

101

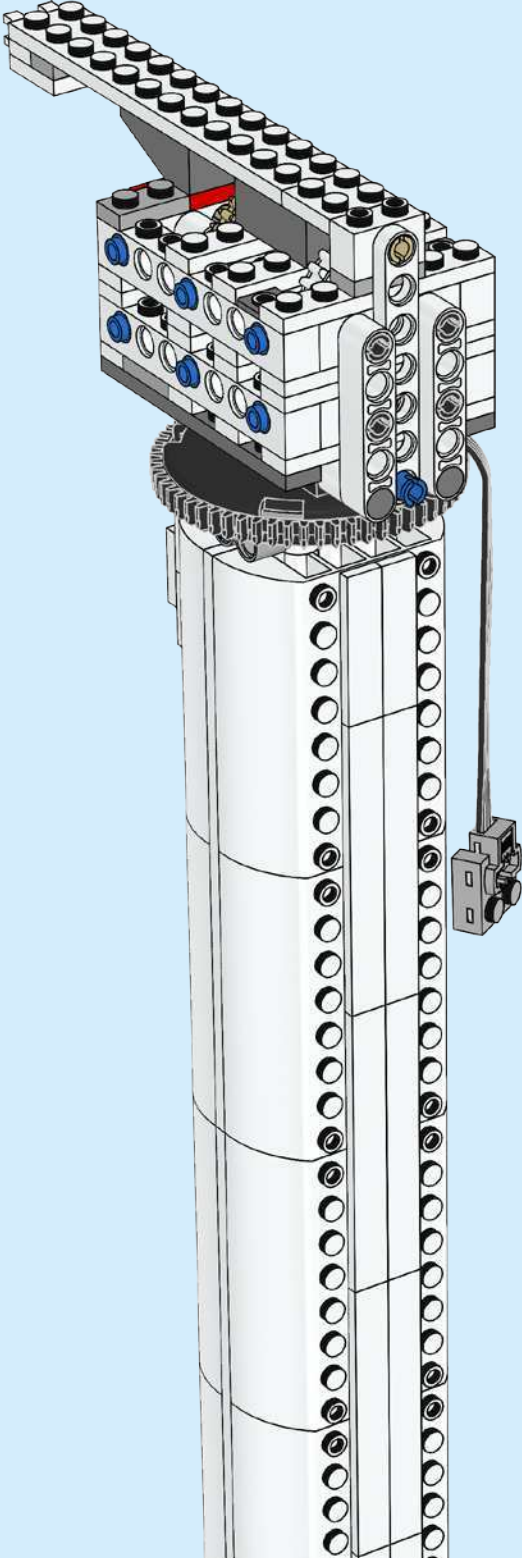

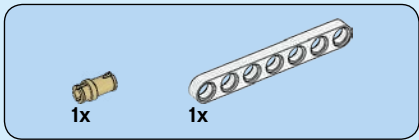

102

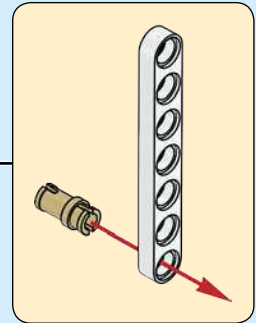
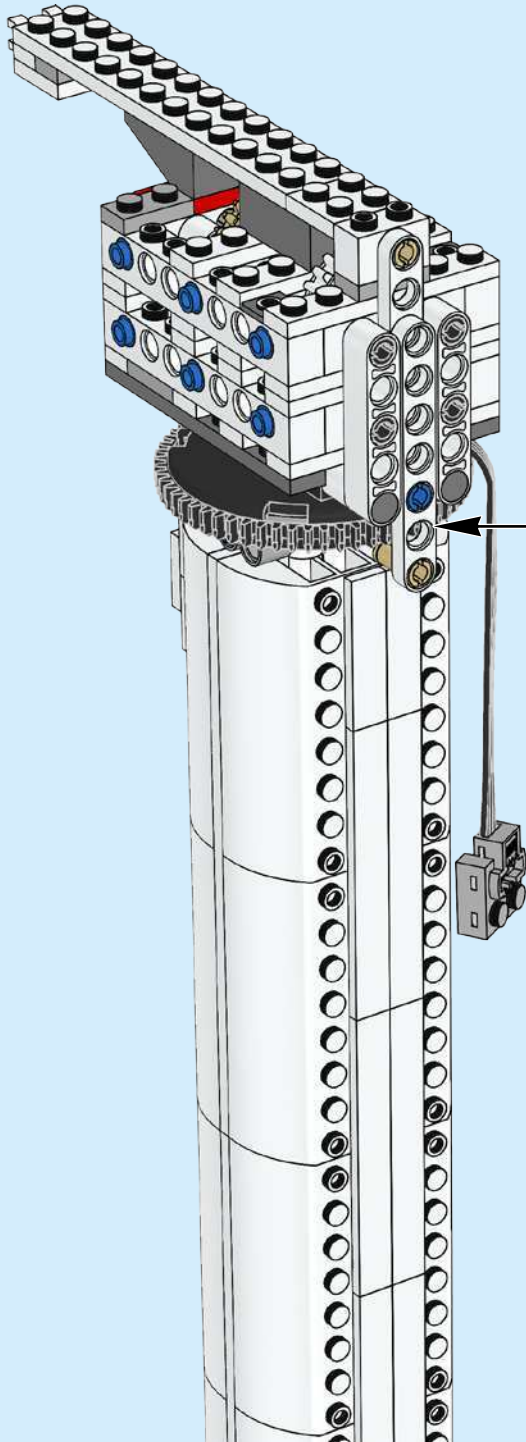

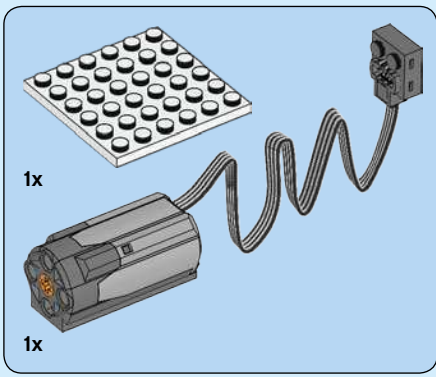

103

1

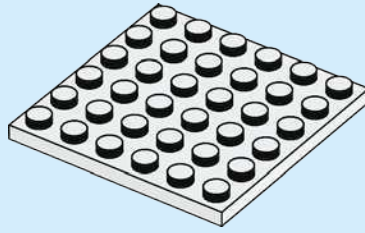

2

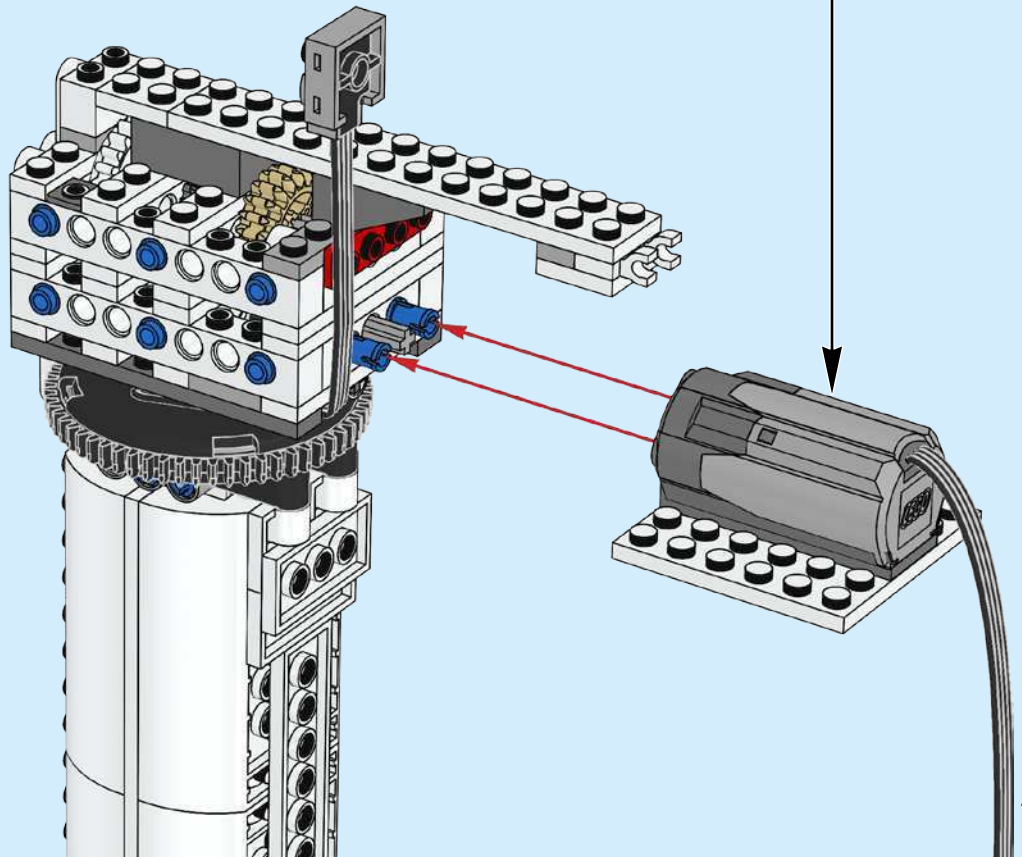
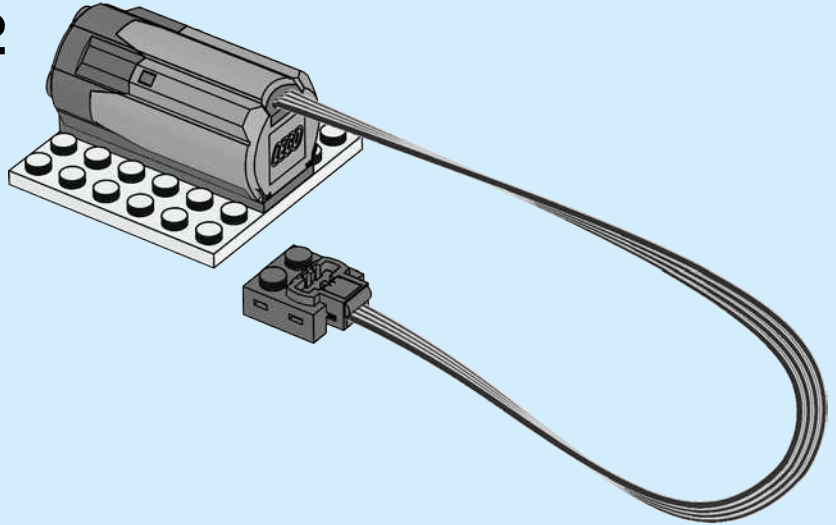

The nacelle within the model contains a generator to convert the energy captured by the blades to electricity.

104

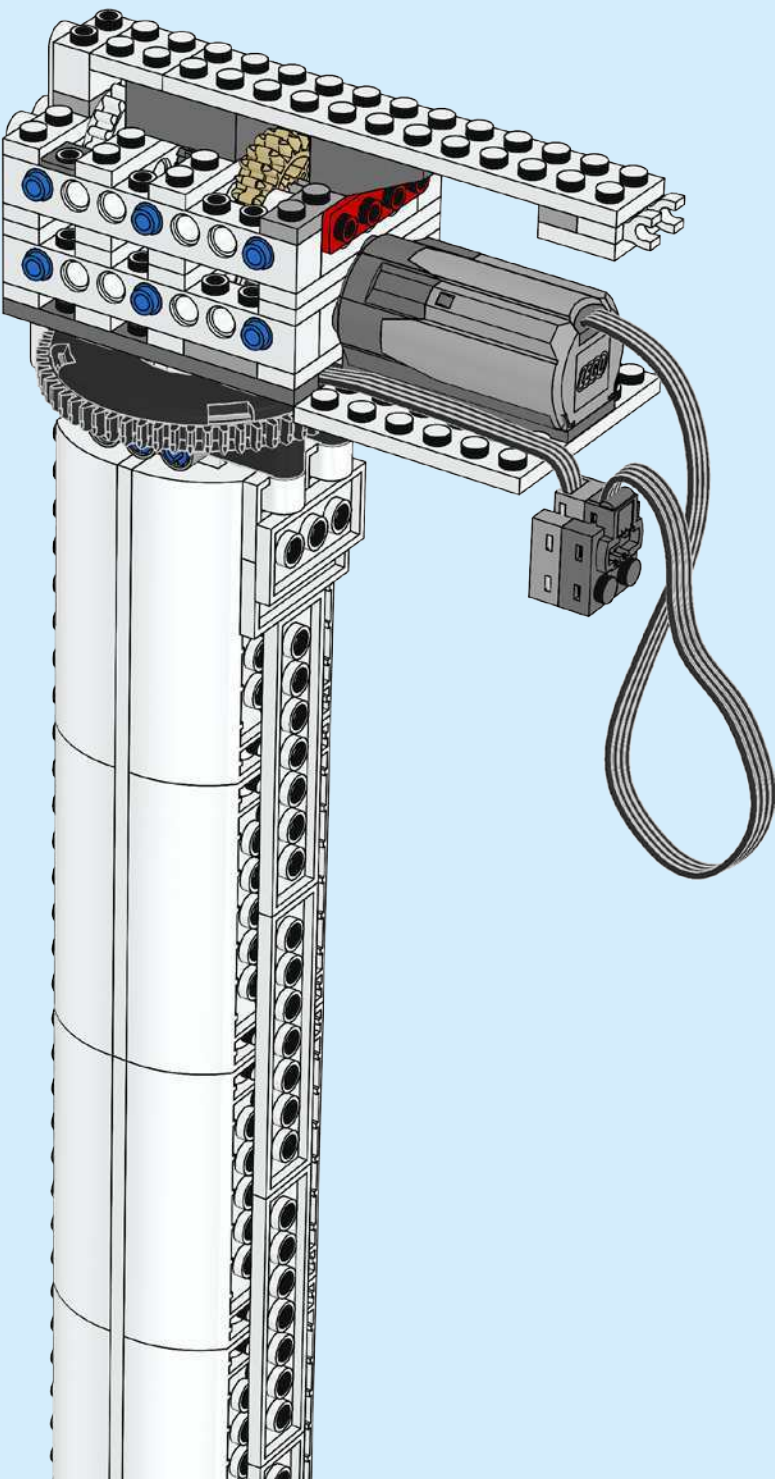

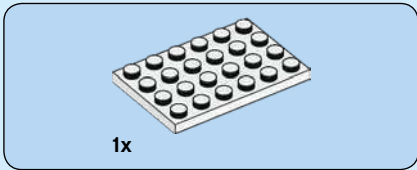

105

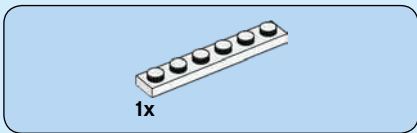
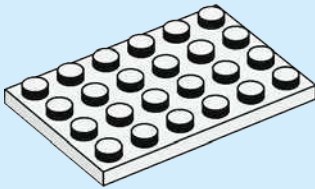

106

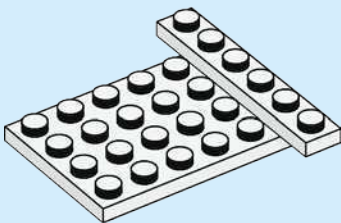

107

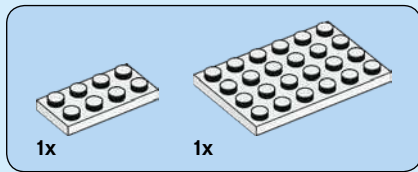
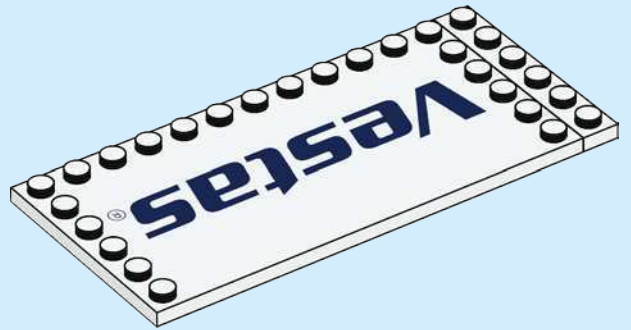

108

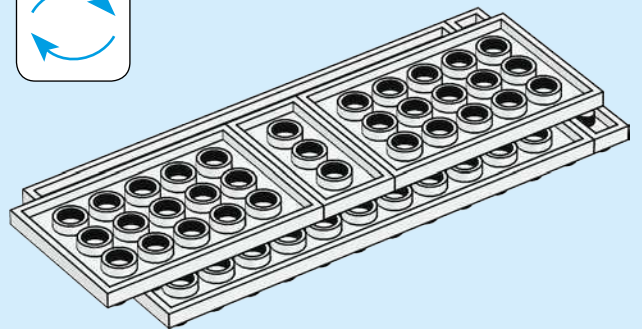
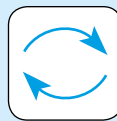

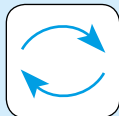
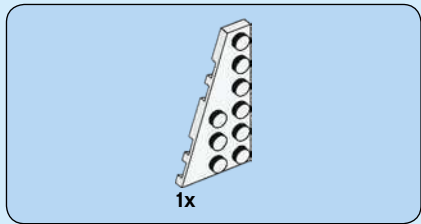

109

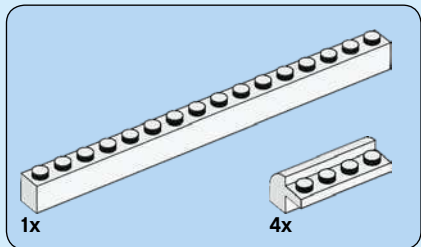

110

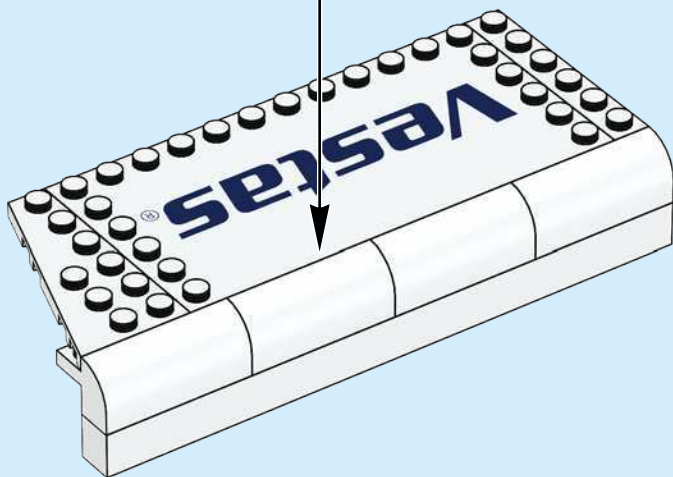
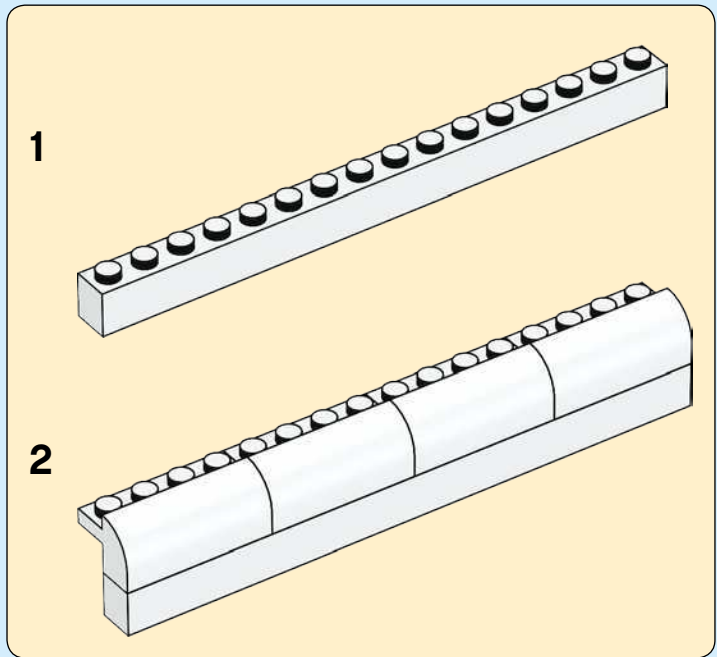

111

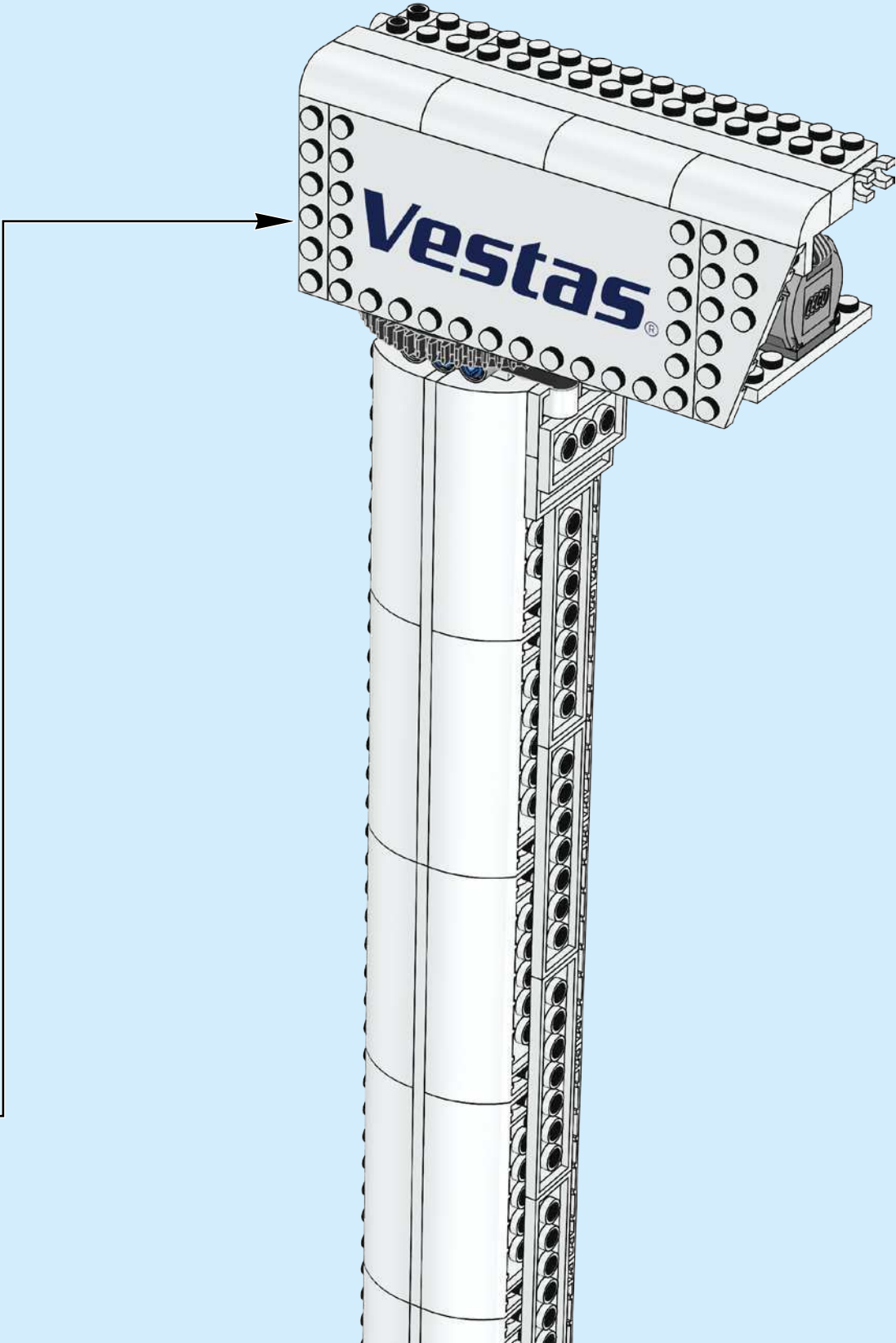

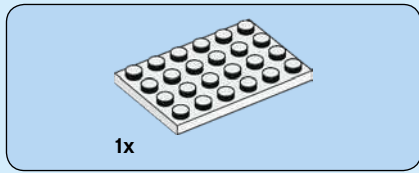

112

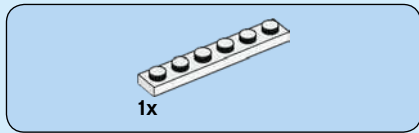
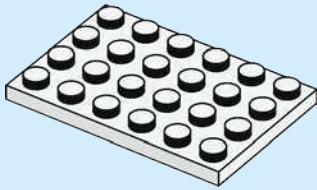

113

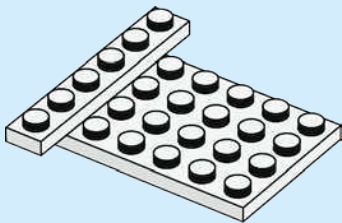

114

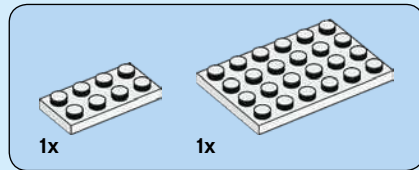
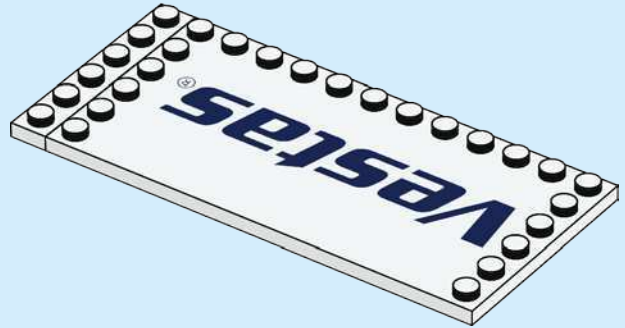

115

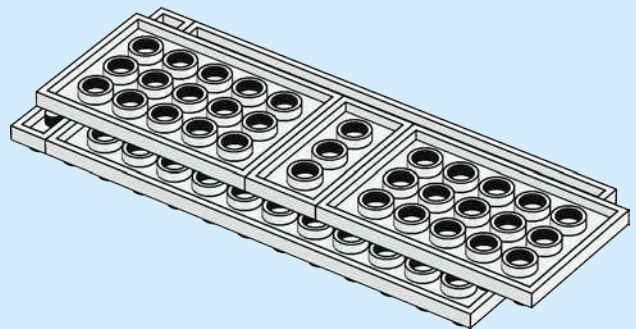
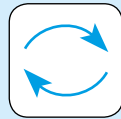

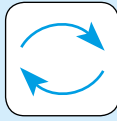
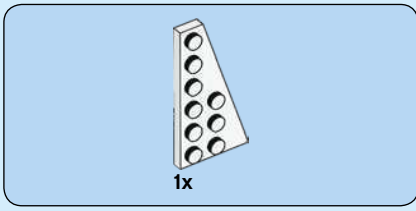

116

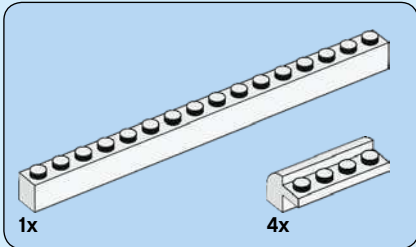
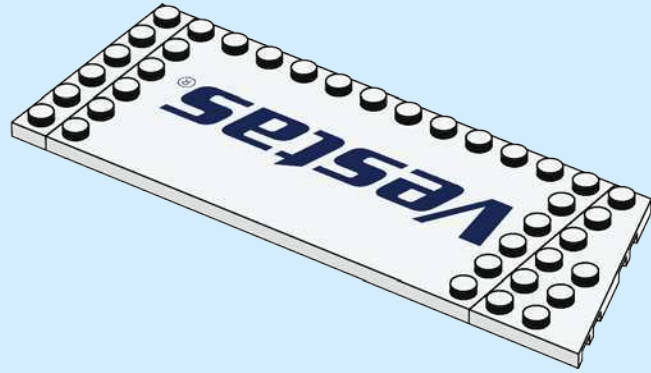

117

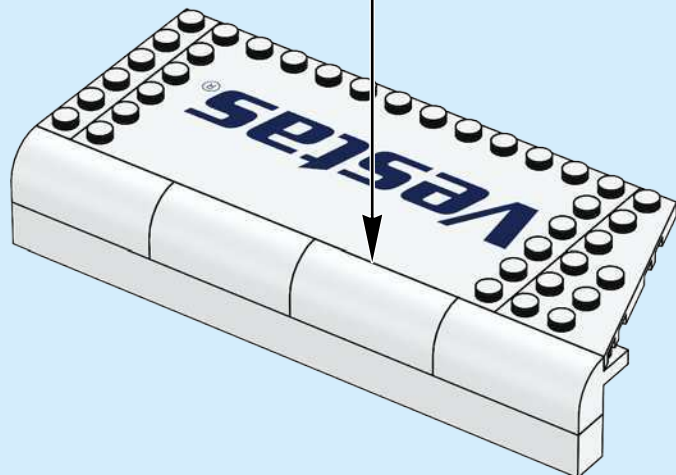
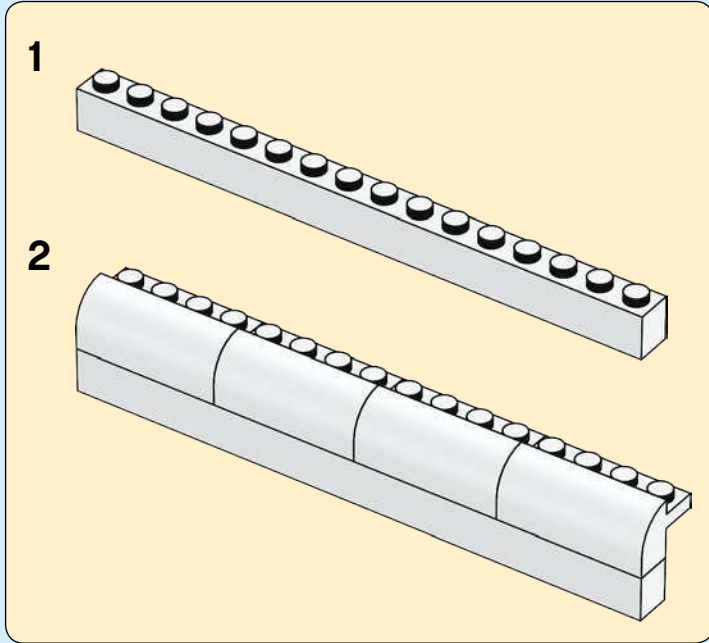

118

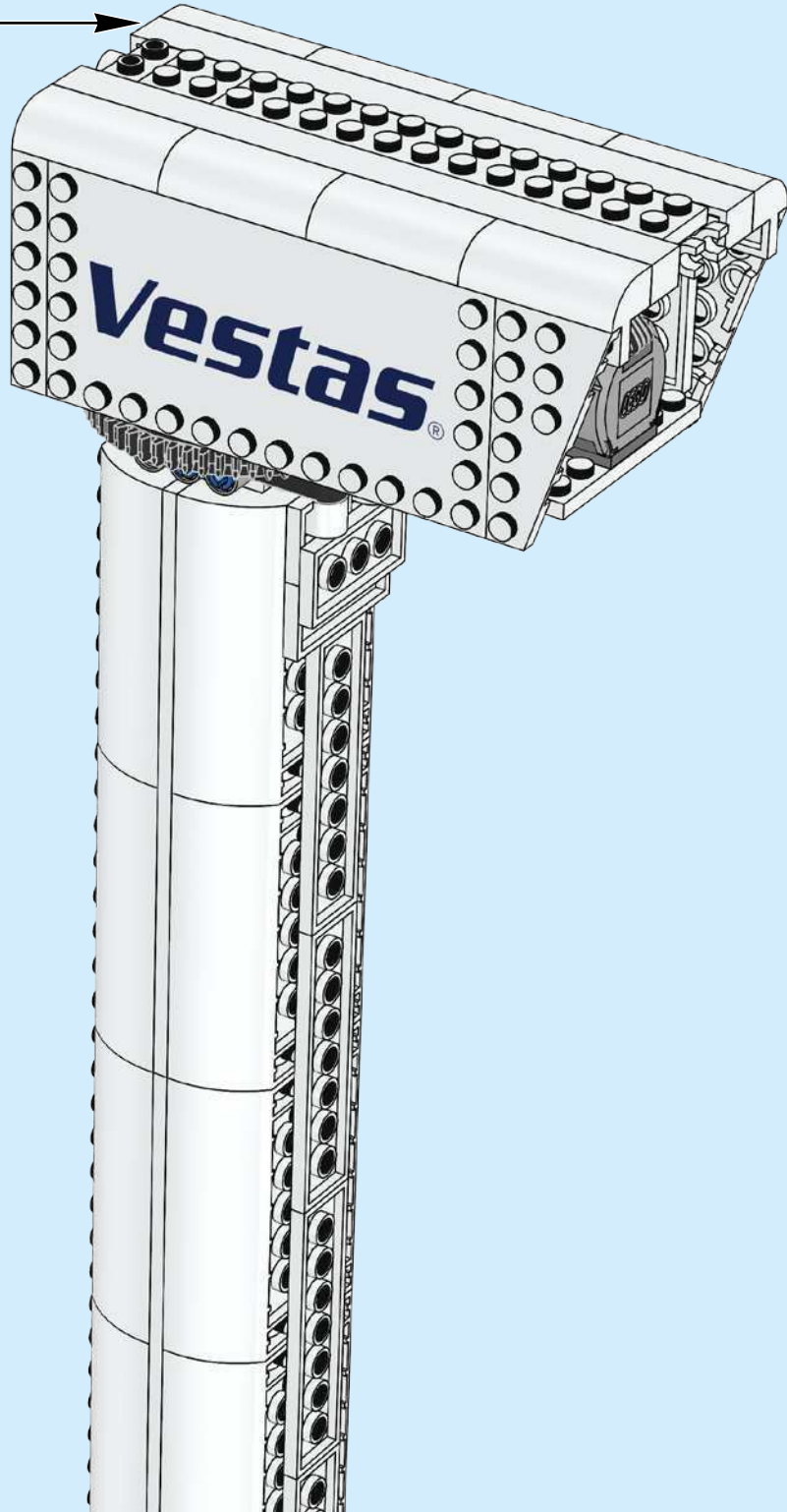

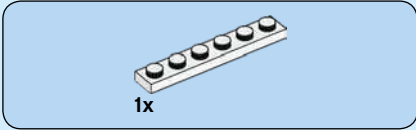
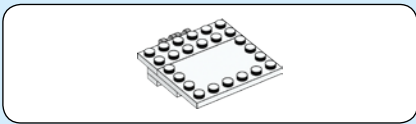

119

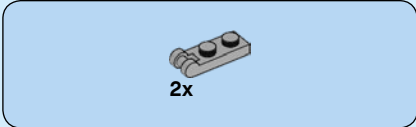
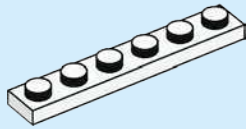

120

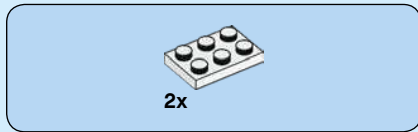
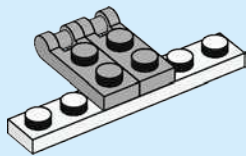

121

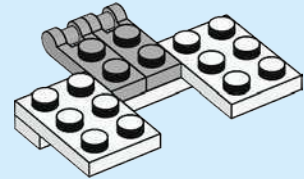

122

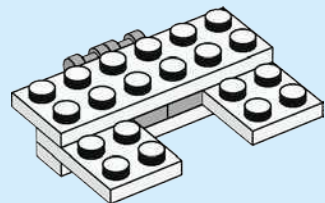

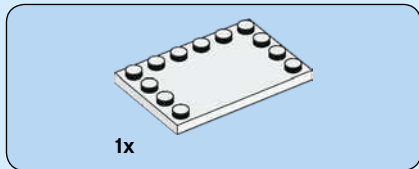

123

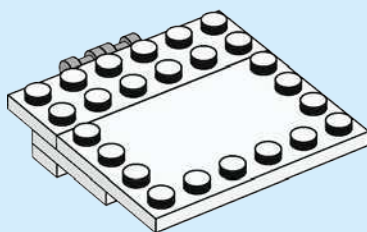

124

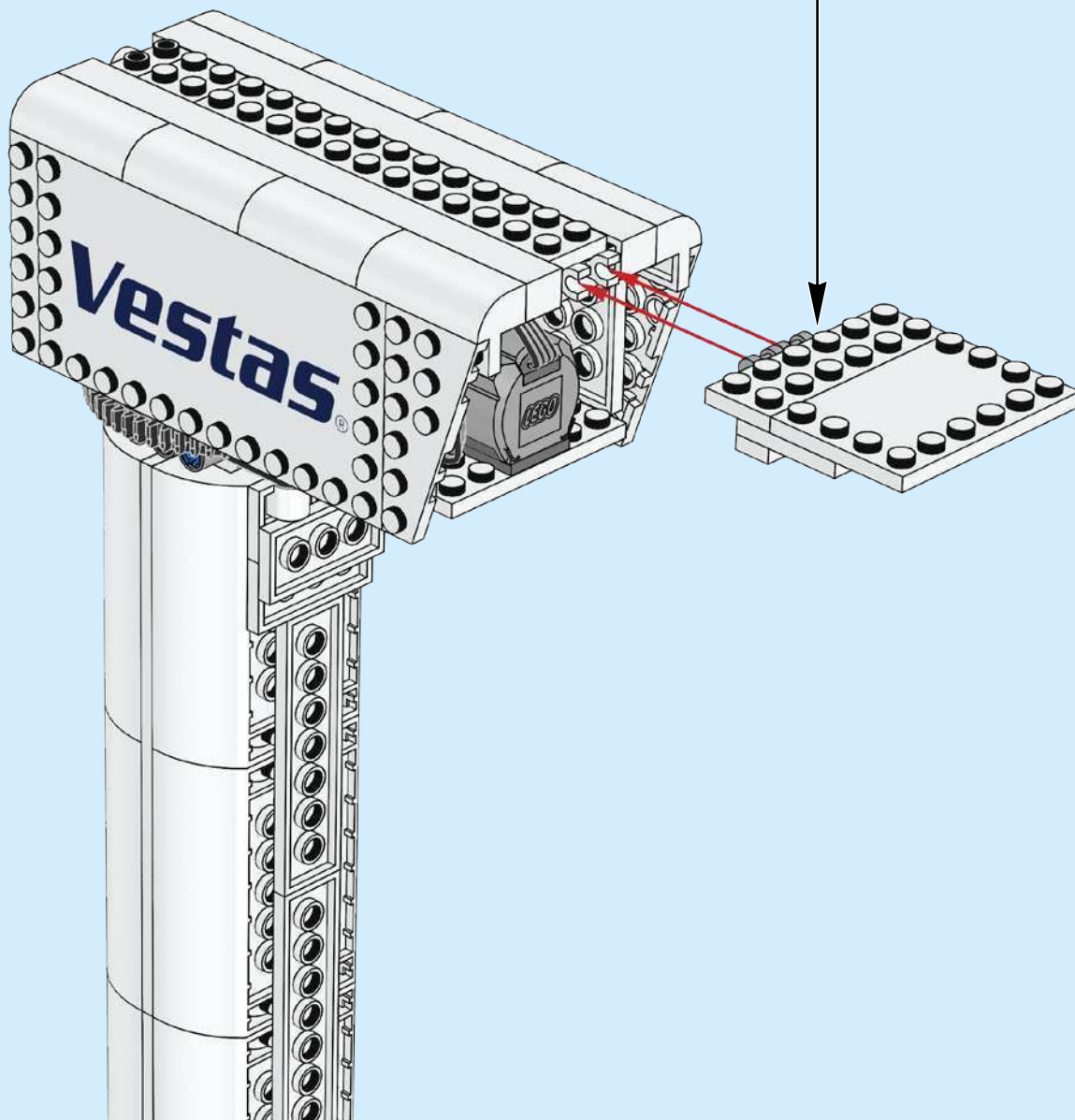

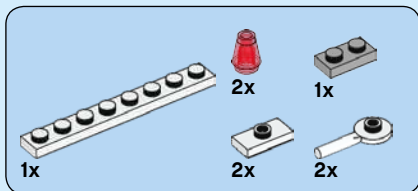

125

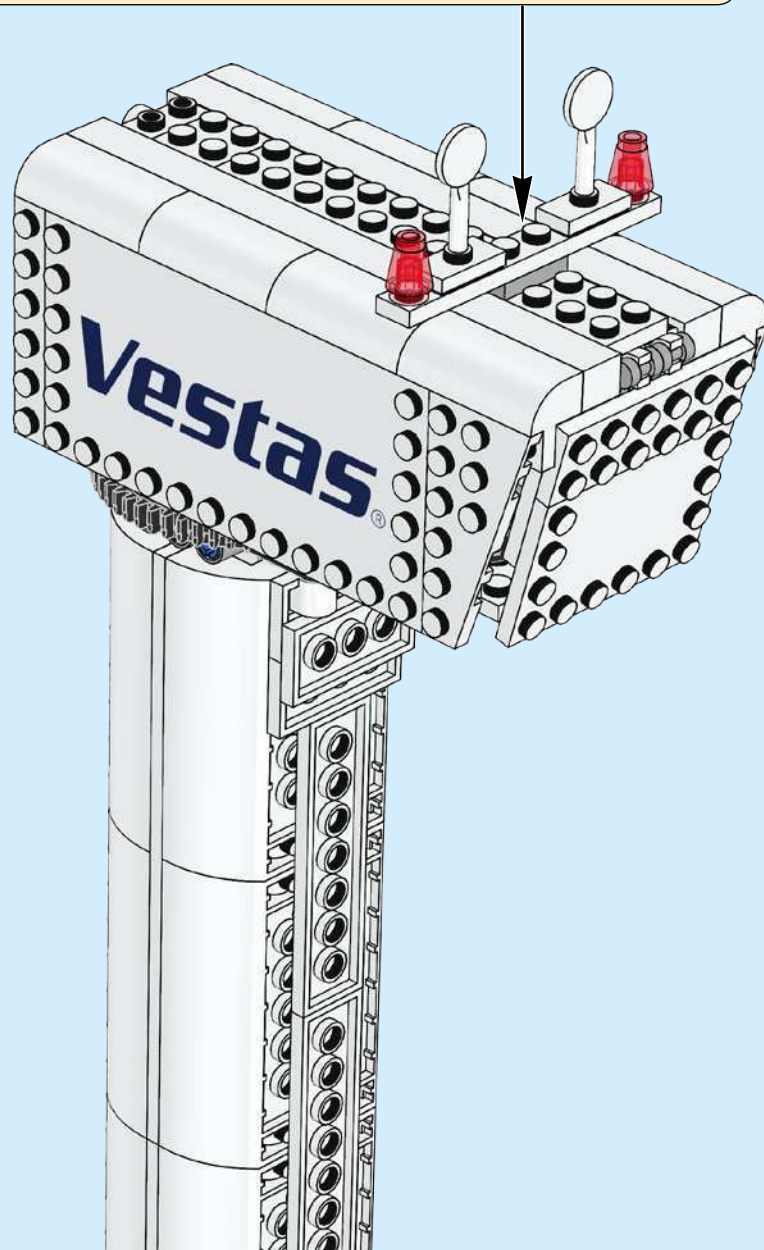
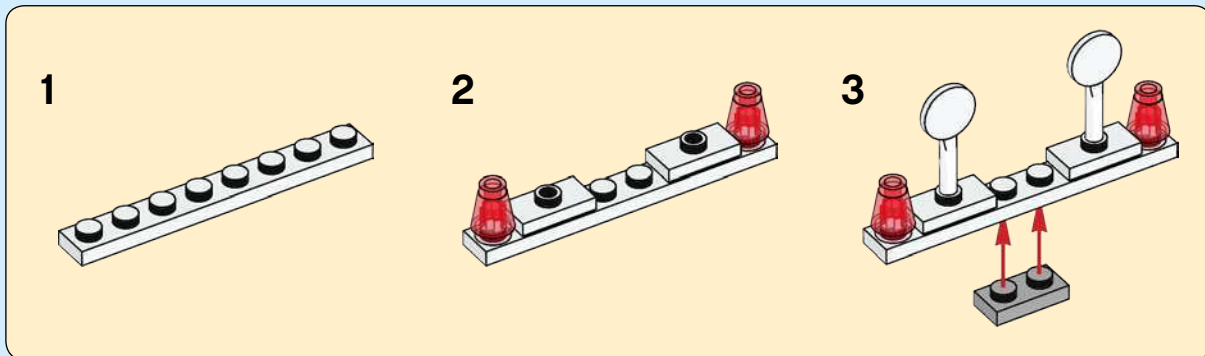

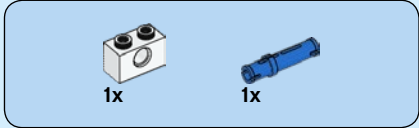
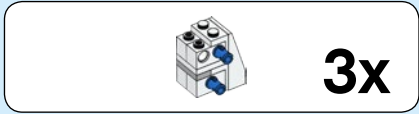
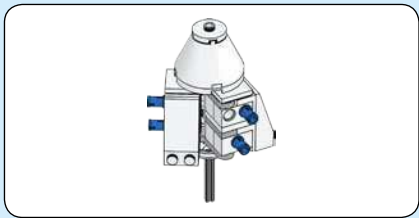

126

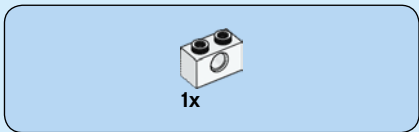
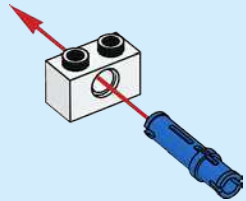

127

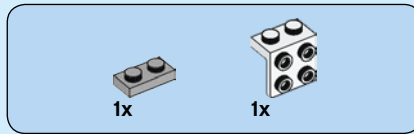
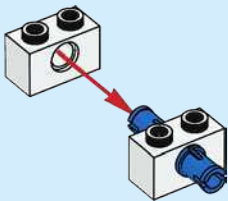

128

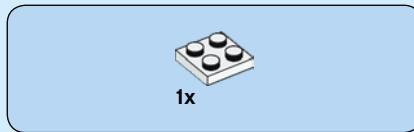
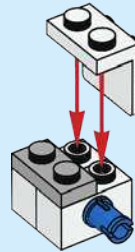

129

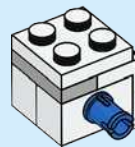

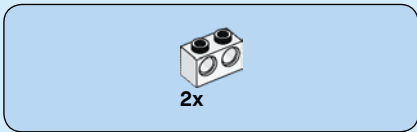

130

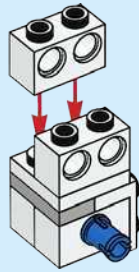

131

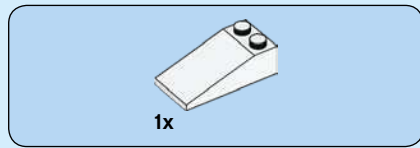
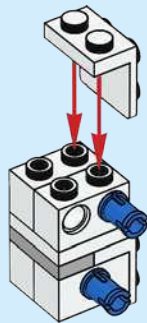

132

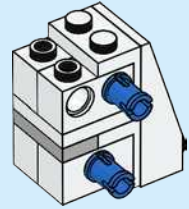

3x

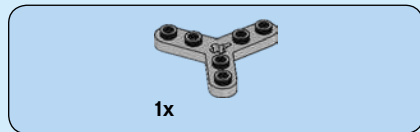

133

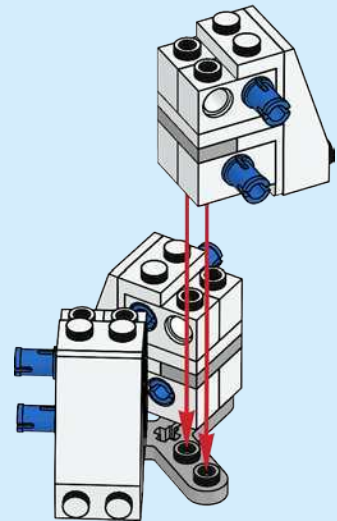

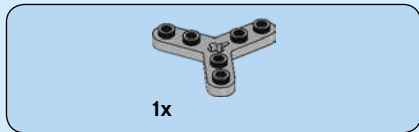

134

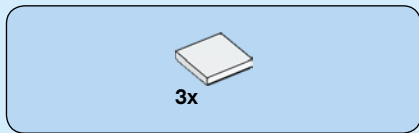
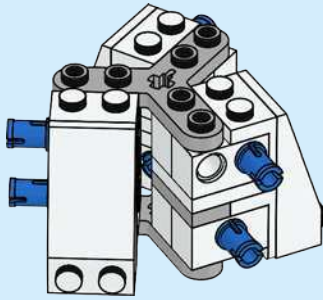
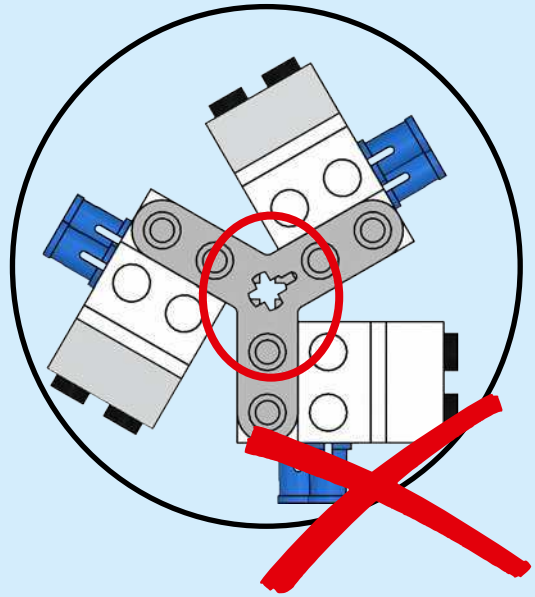
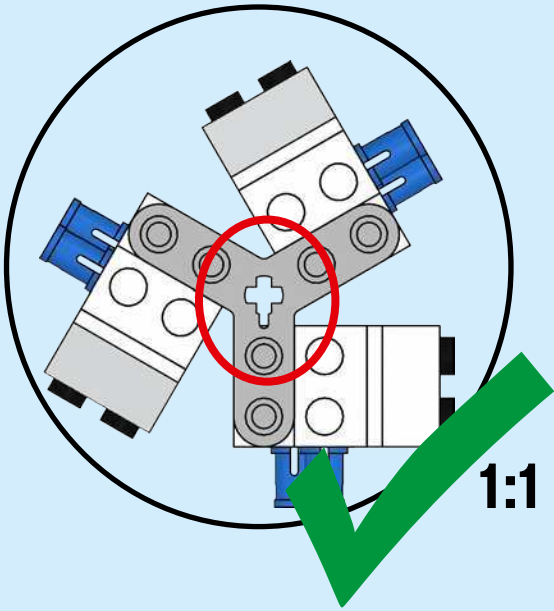

135

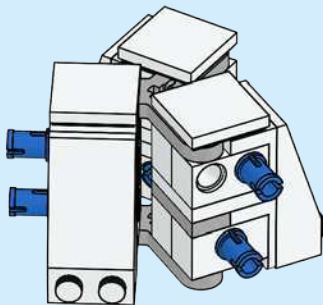

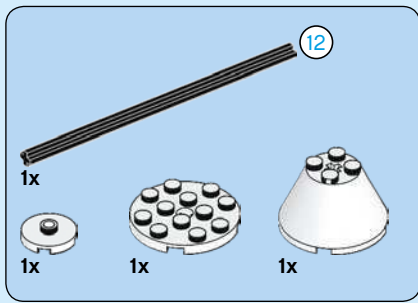

136

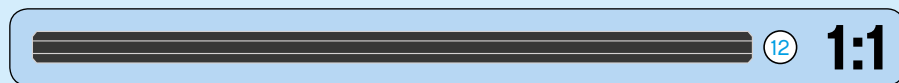
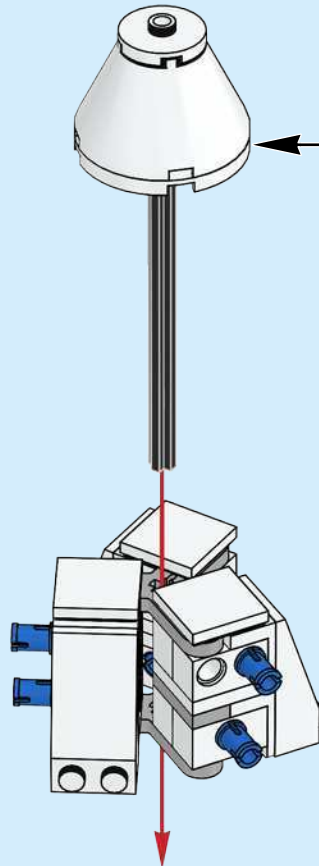
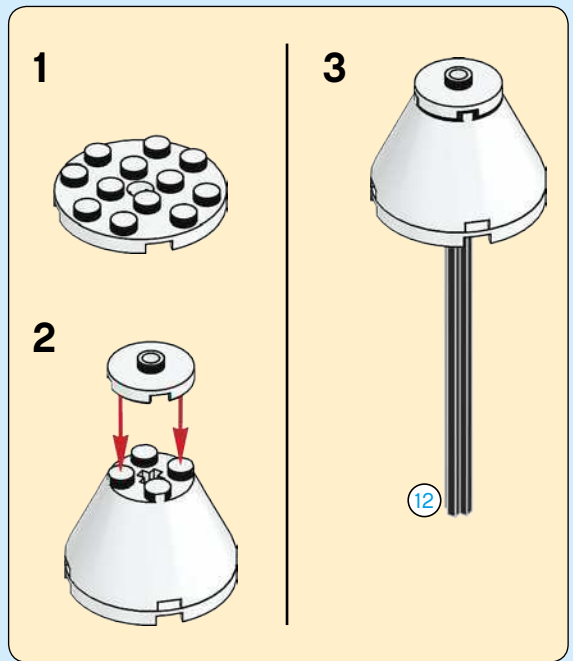

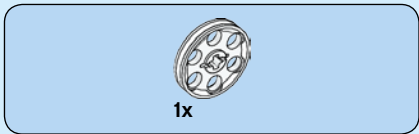

137

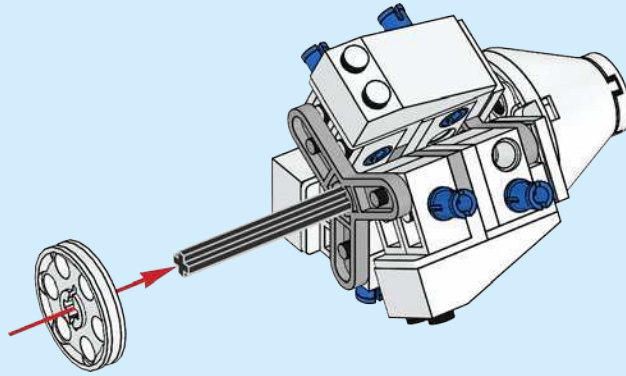
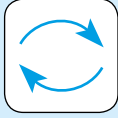

138

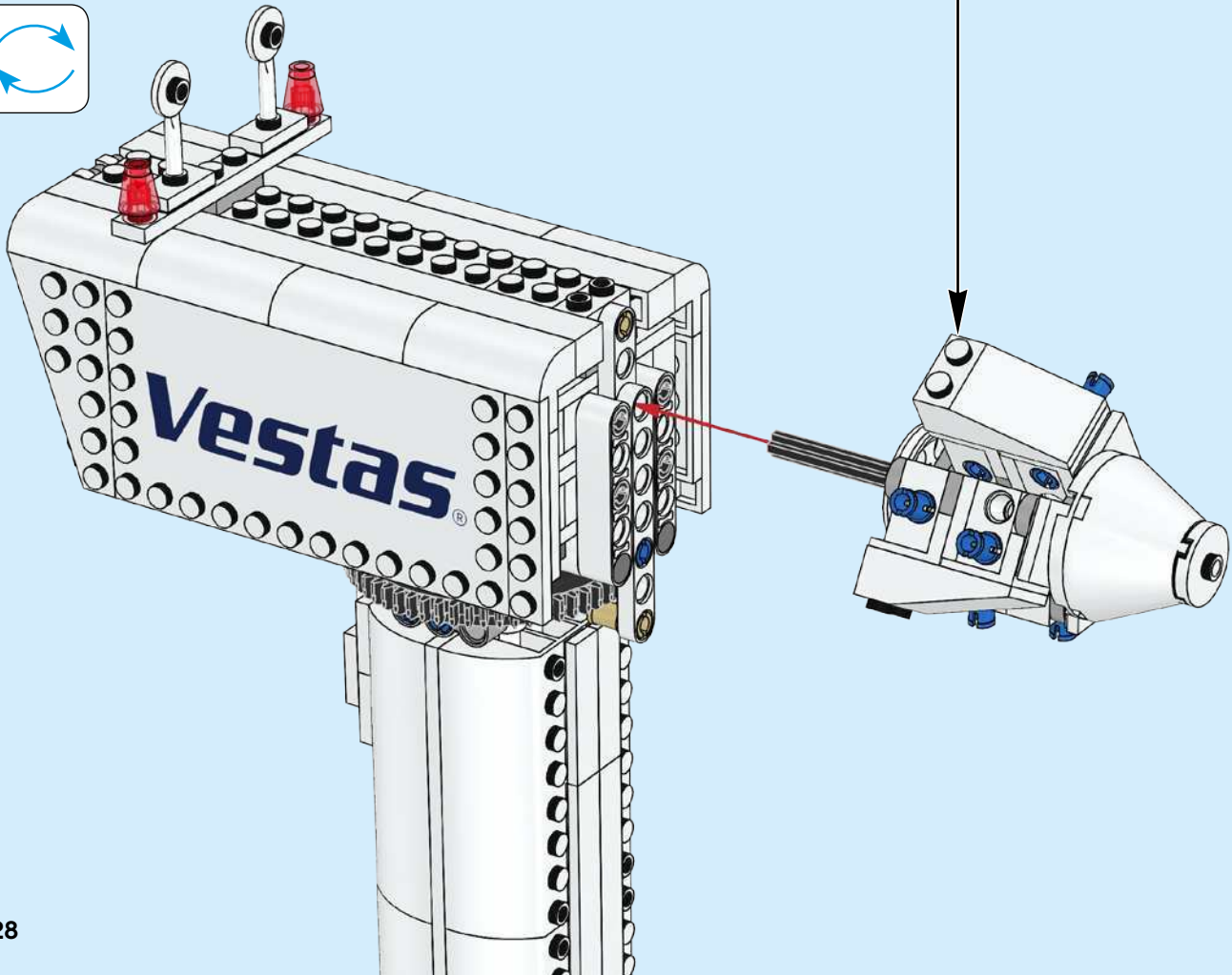

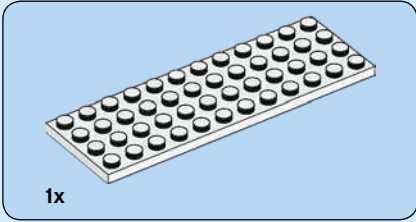
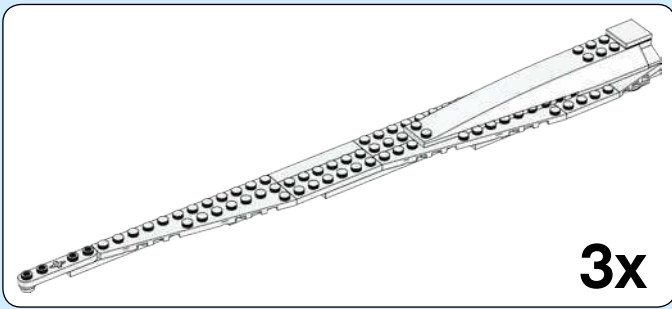

139

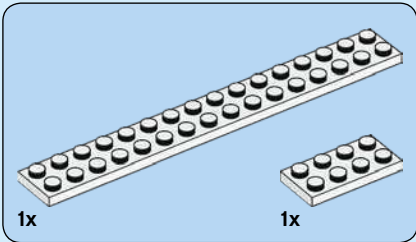
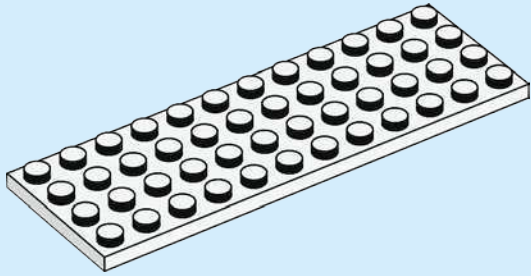

140

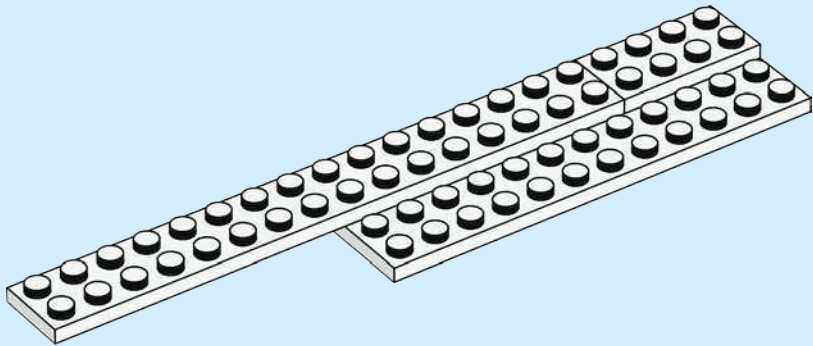

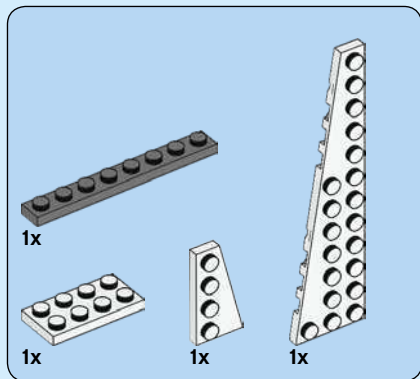

141

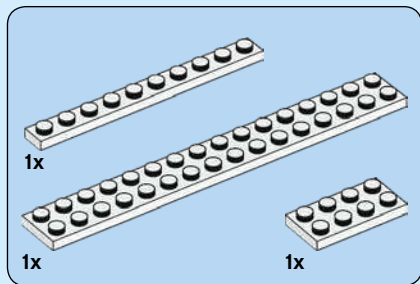
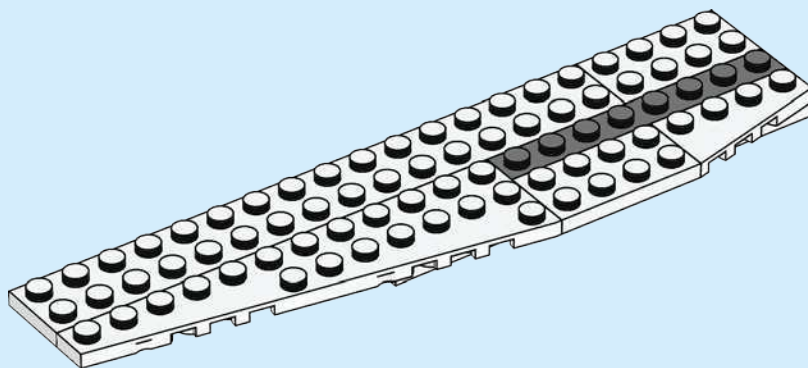

142

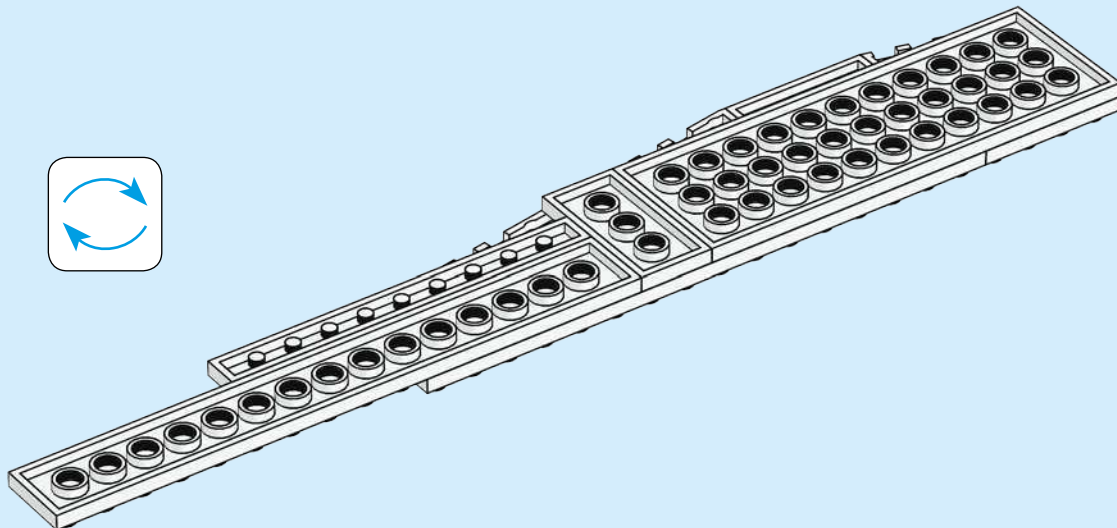
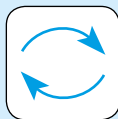

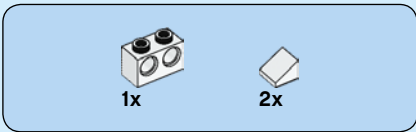

143

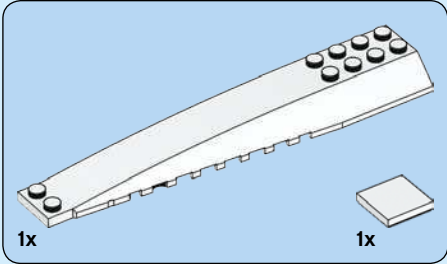
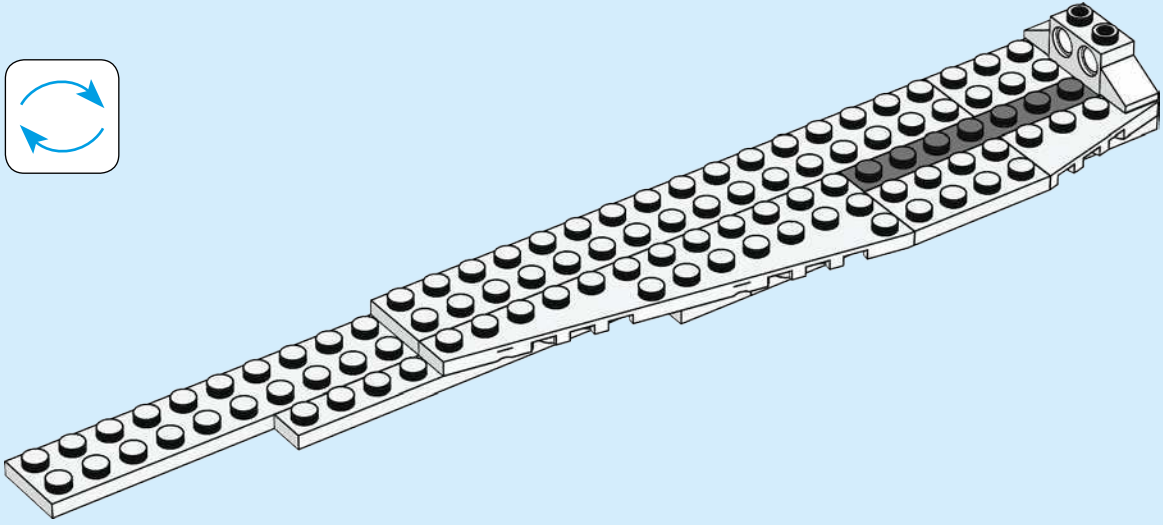
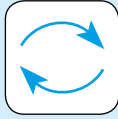

144

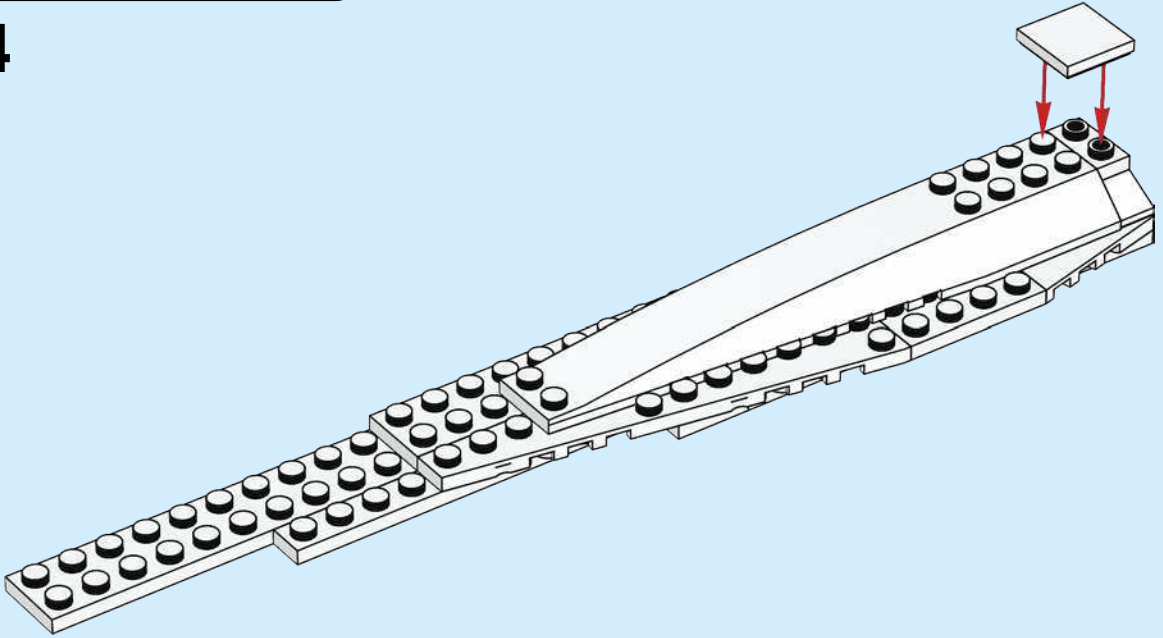

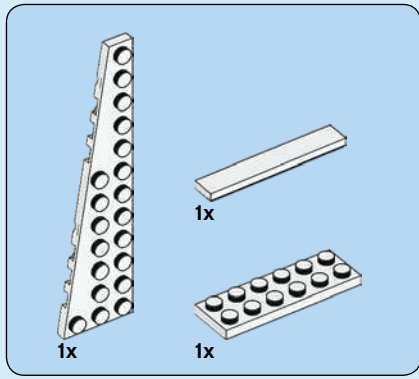

145

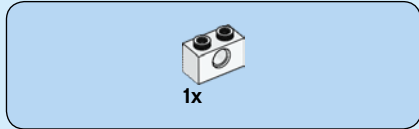
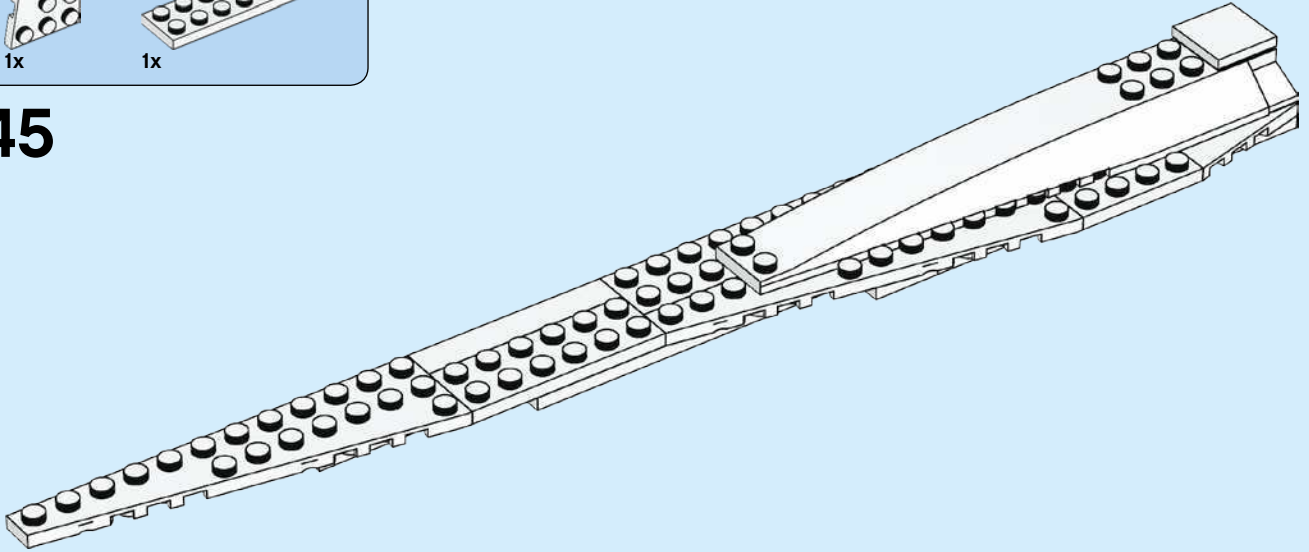

146

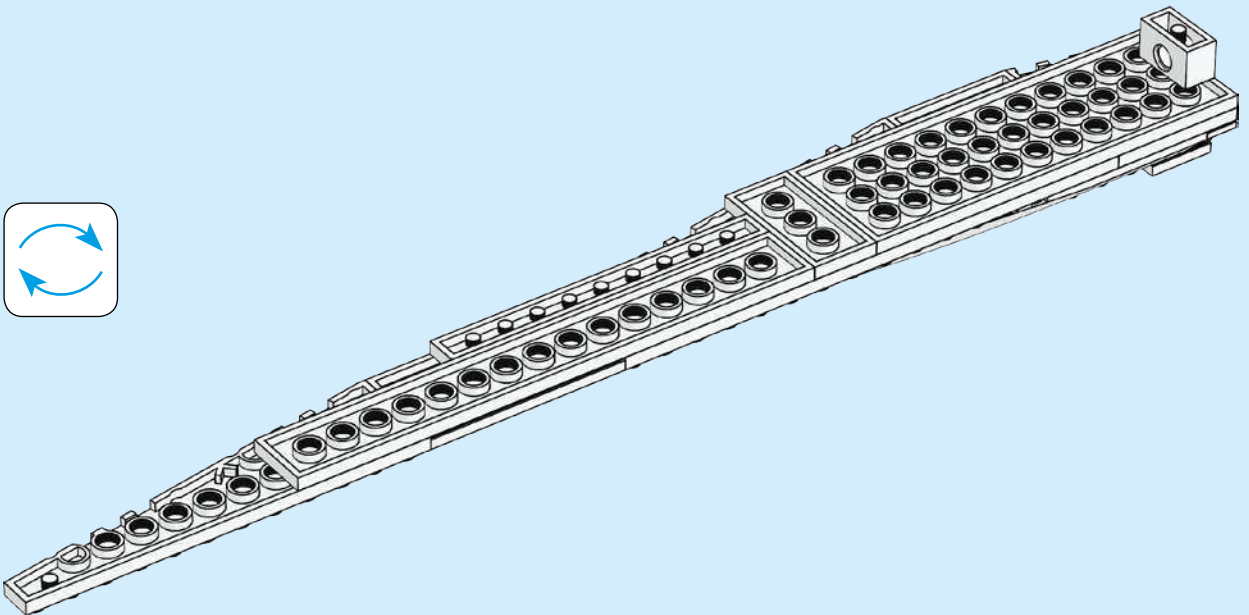
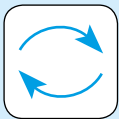

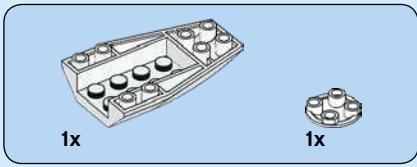

147

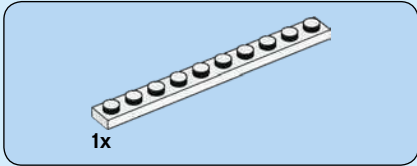
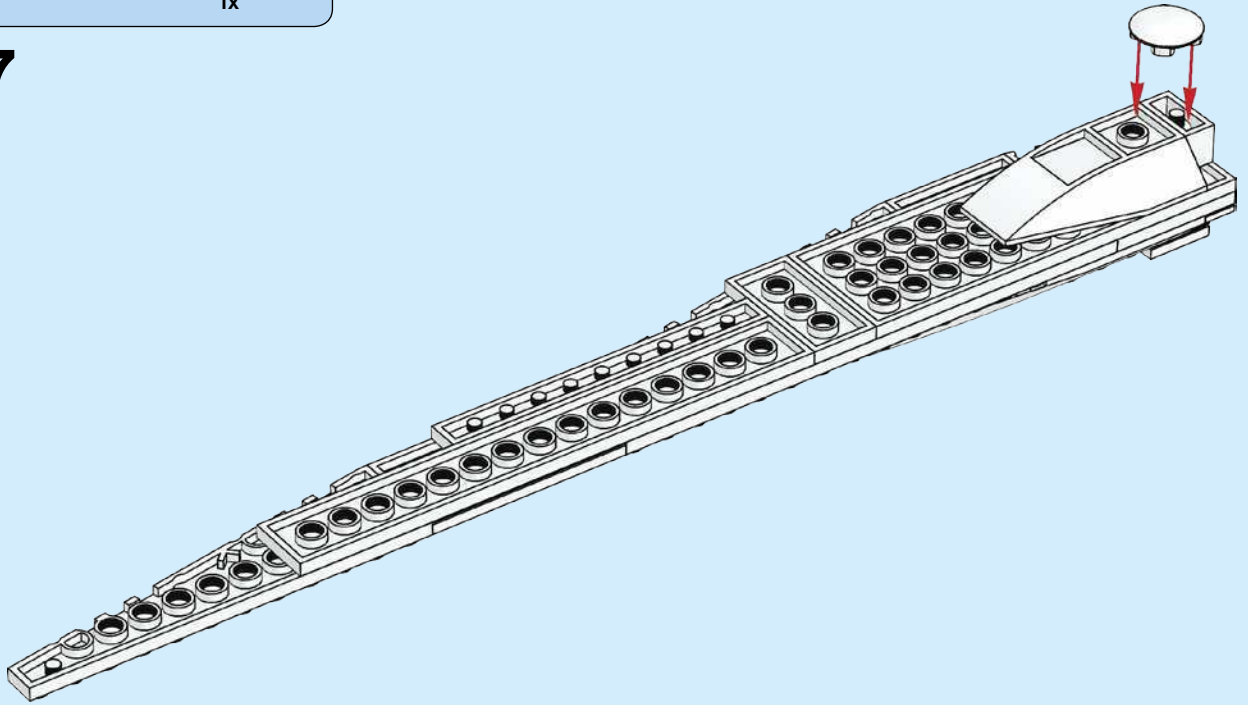

148

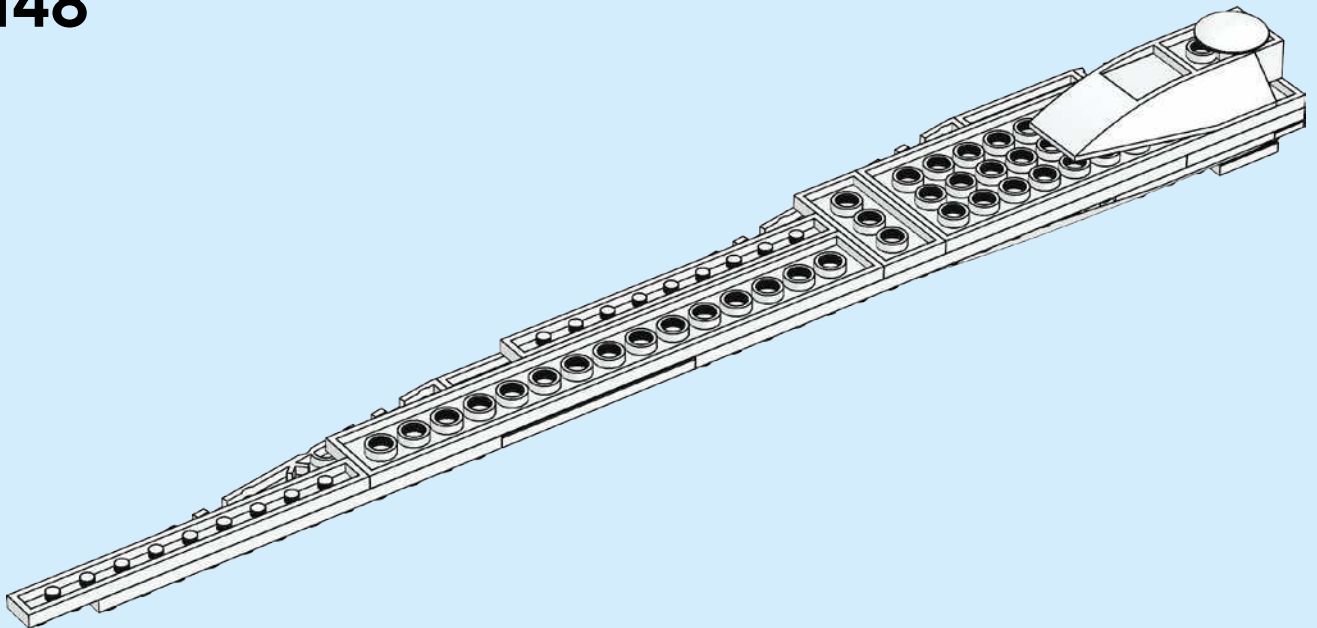

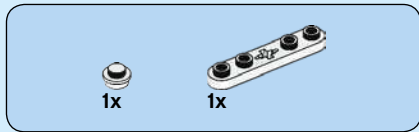

149

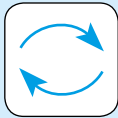
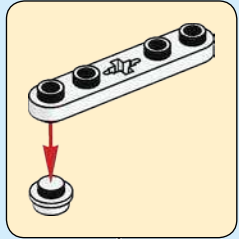
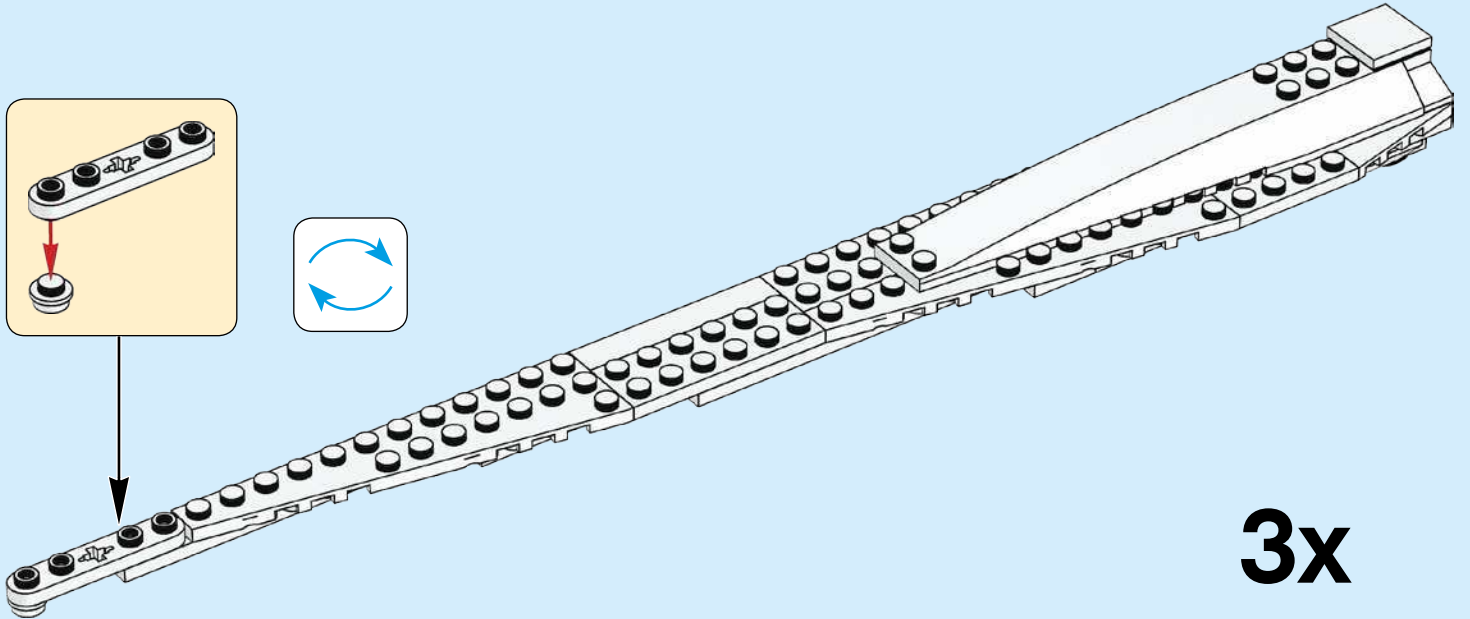

150

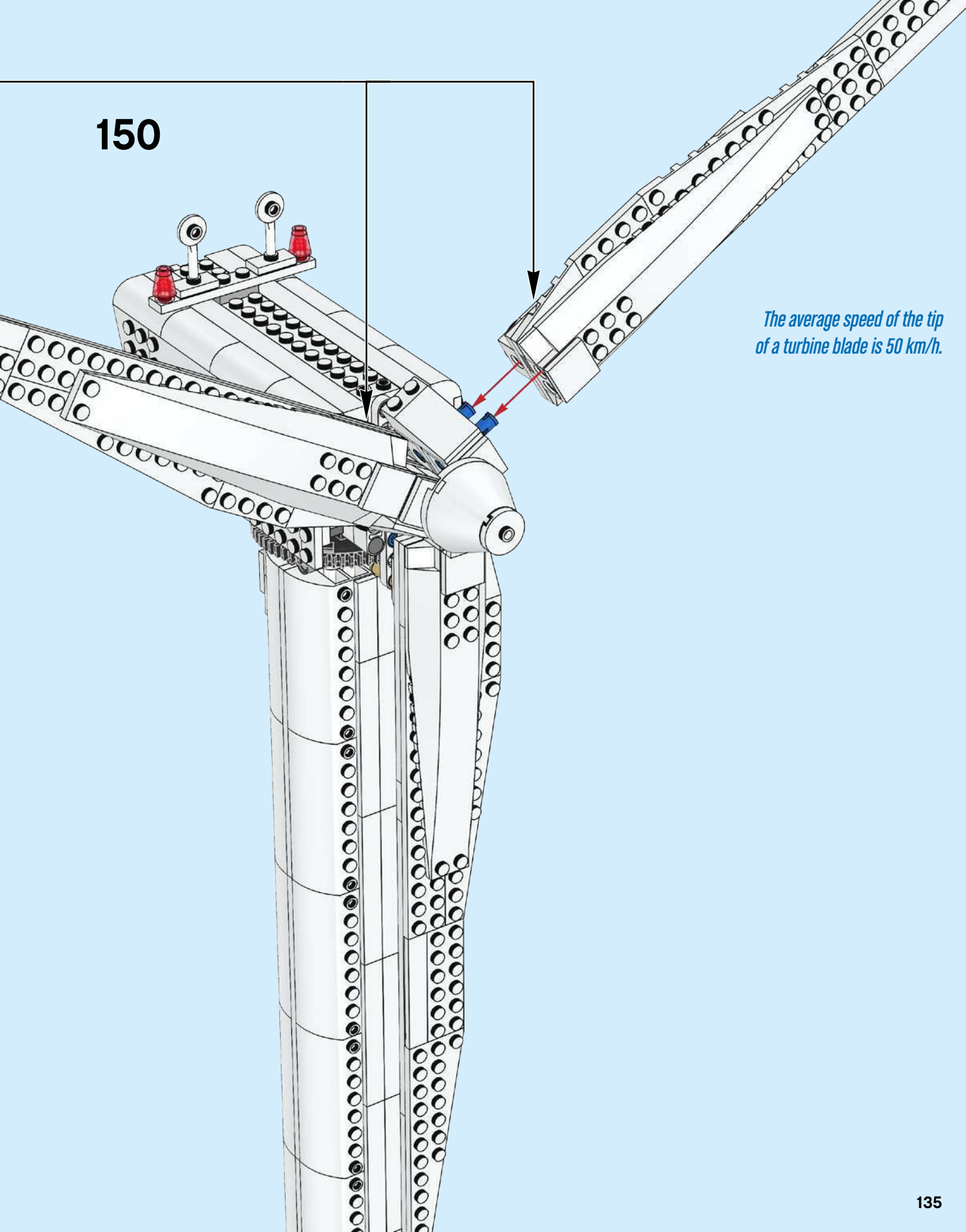

*The average speed of the tip
of a turbine blade is 50 km/h.*

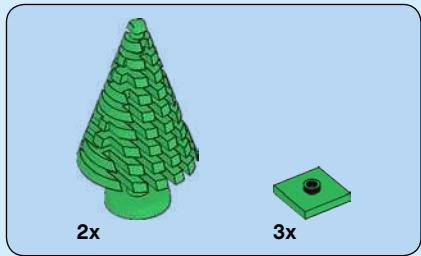

151

The large spruce tree in this model is made of sustainably sourced plant-based plastic.

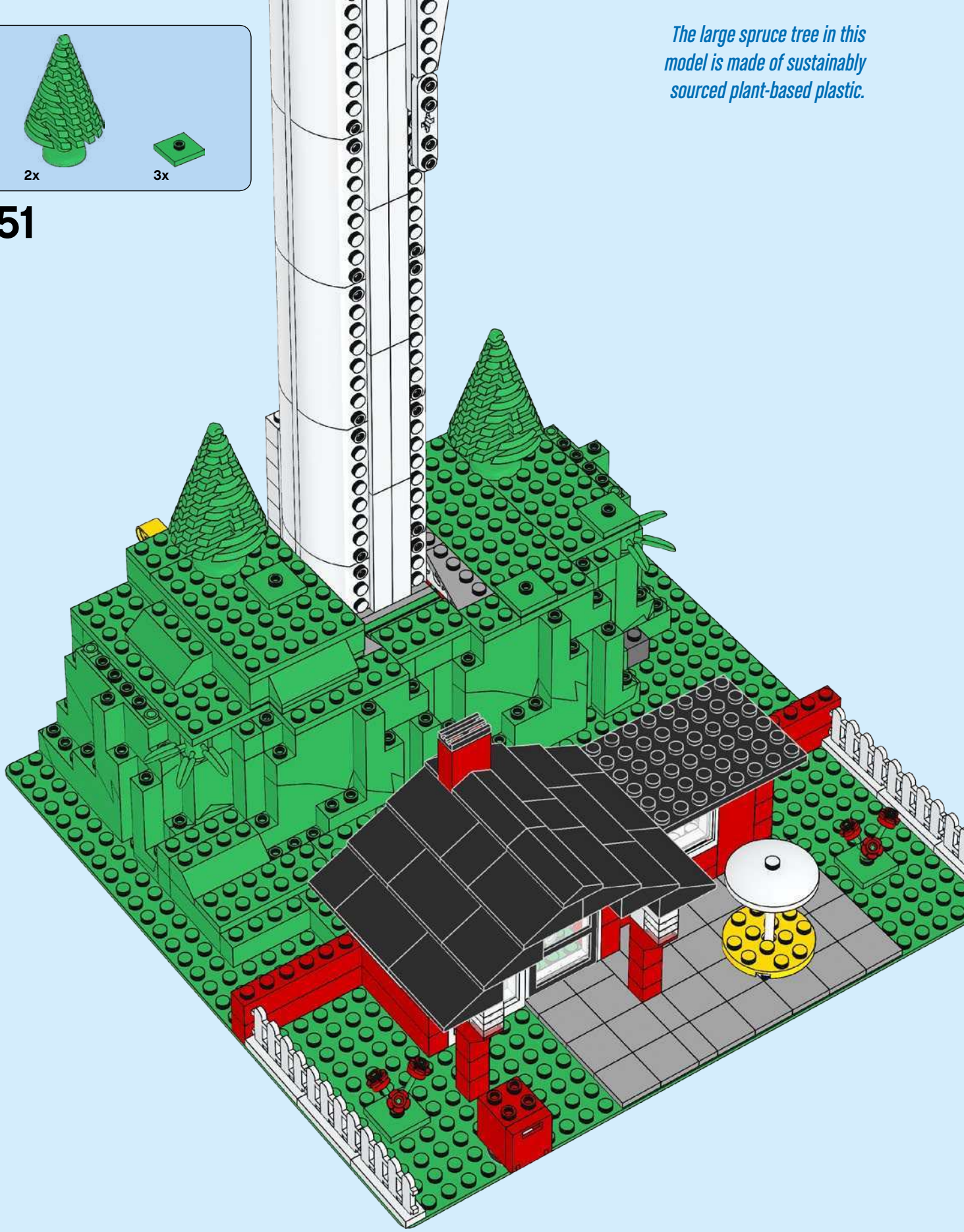

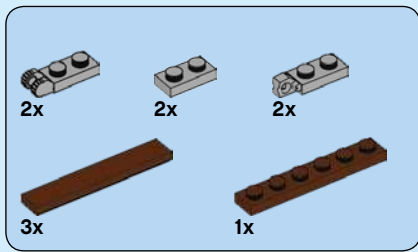

152

1

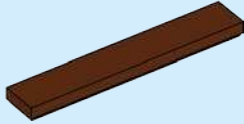

2

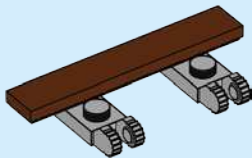

3

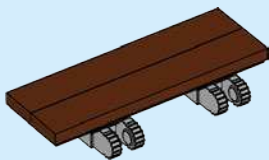

4

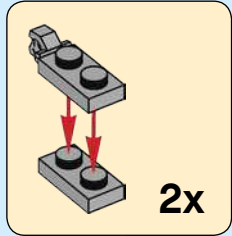
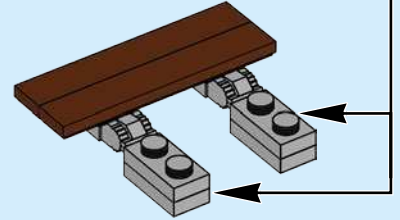

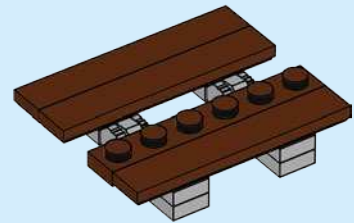

5

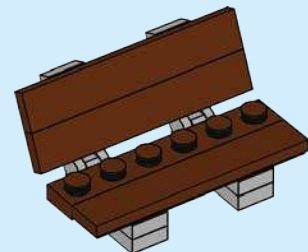

6

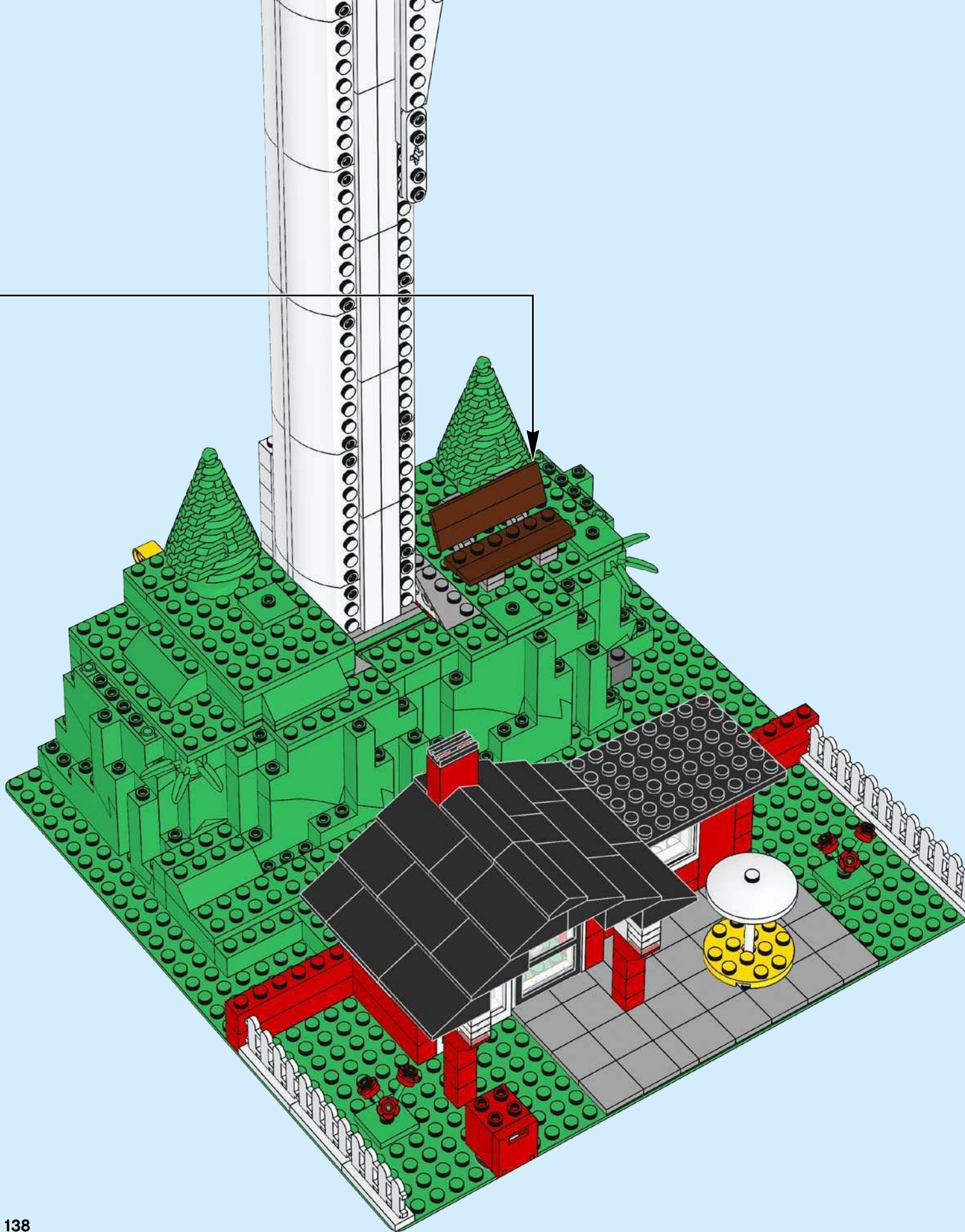



3x  9x 

153

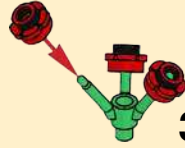
 3x

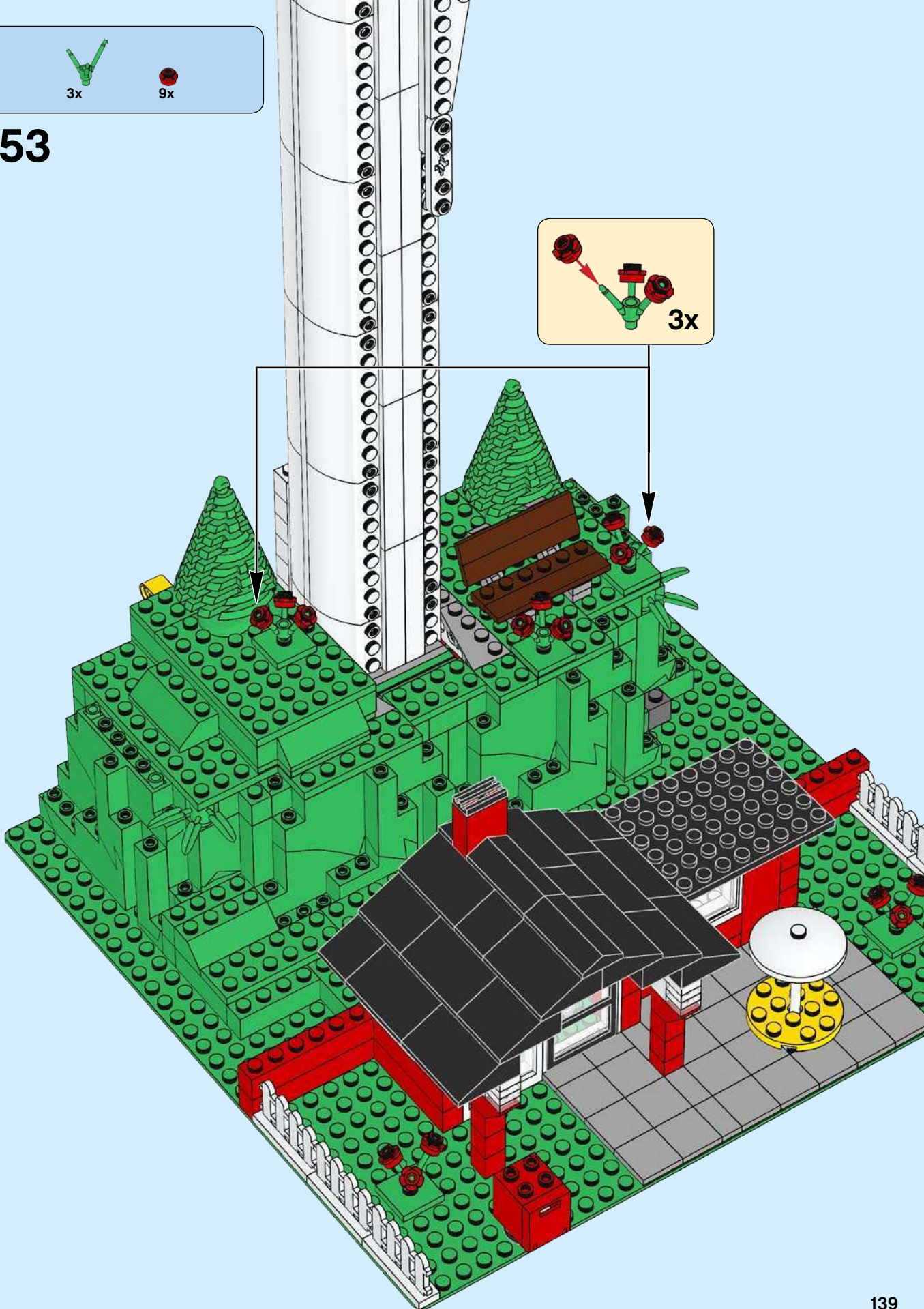

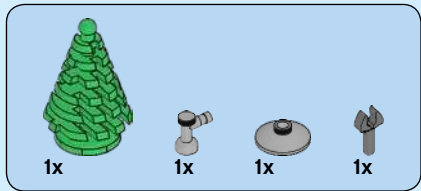

154

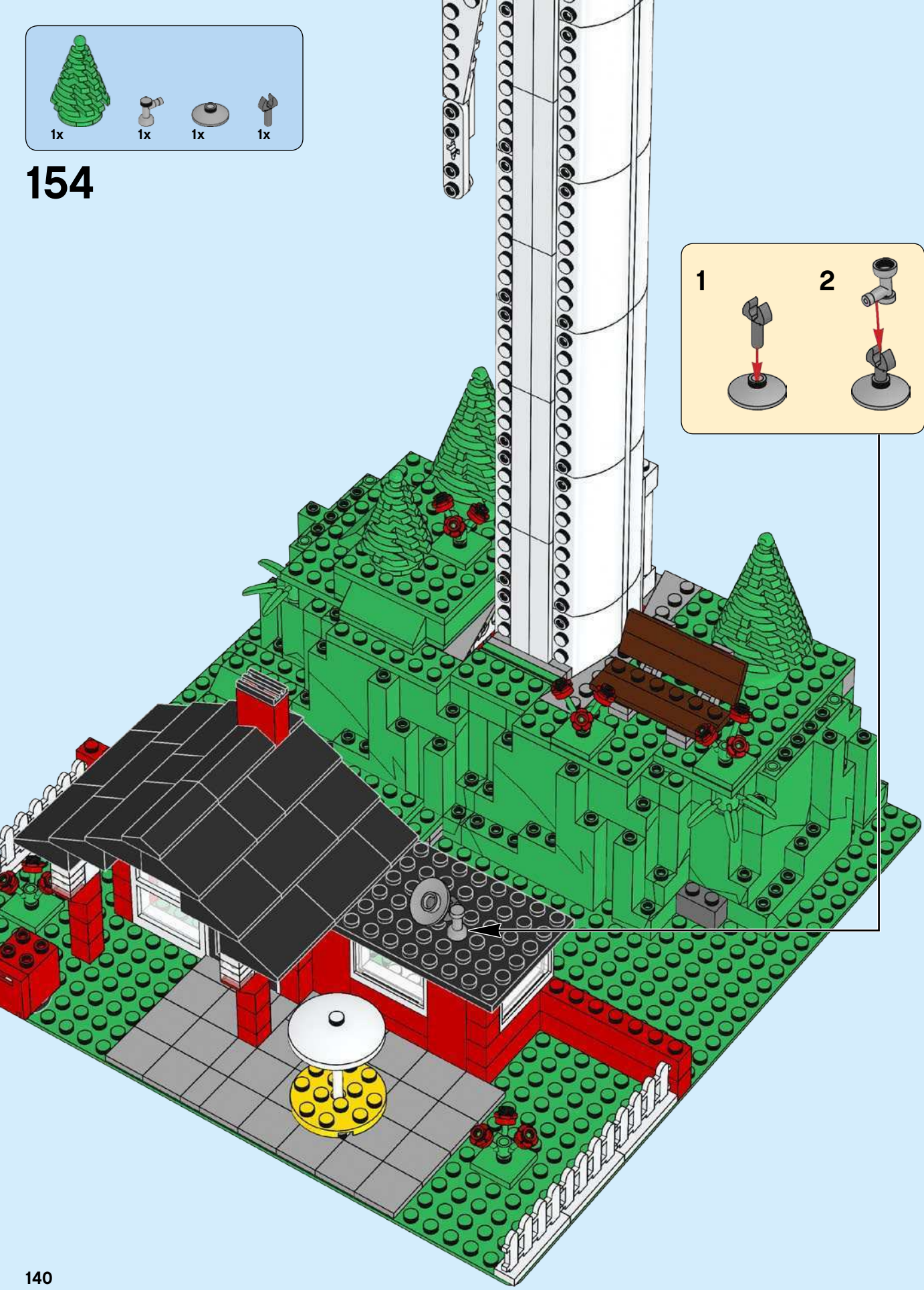

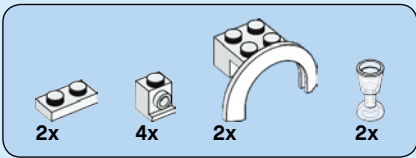

155

- 1
- 2
- 3

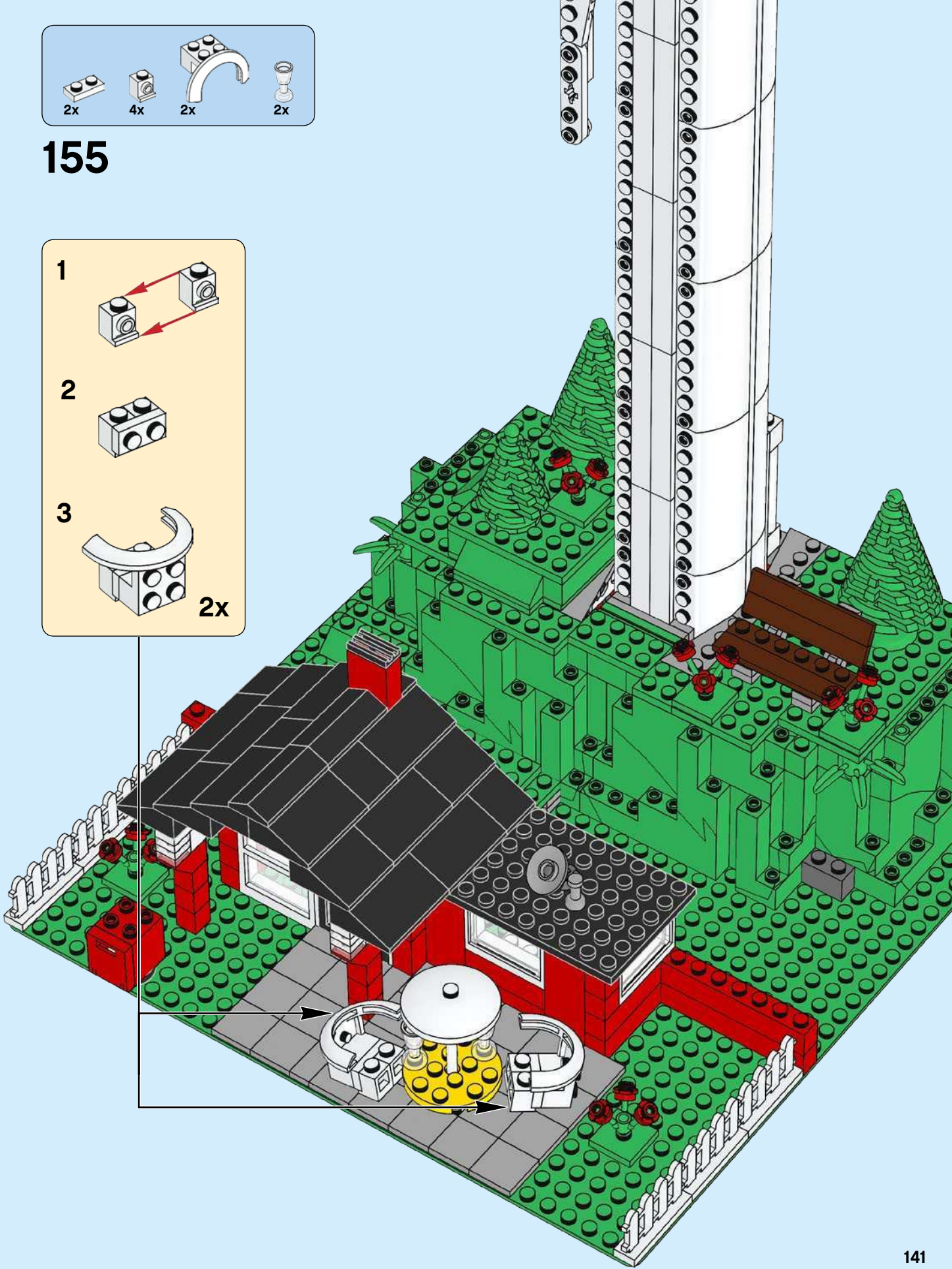

+80,000 tons of CO₂ can be saved every year in Europe with only one V112-3.45 MW® Vestas wind turbine, equivalent to the carbon consumption of 5 million trees.

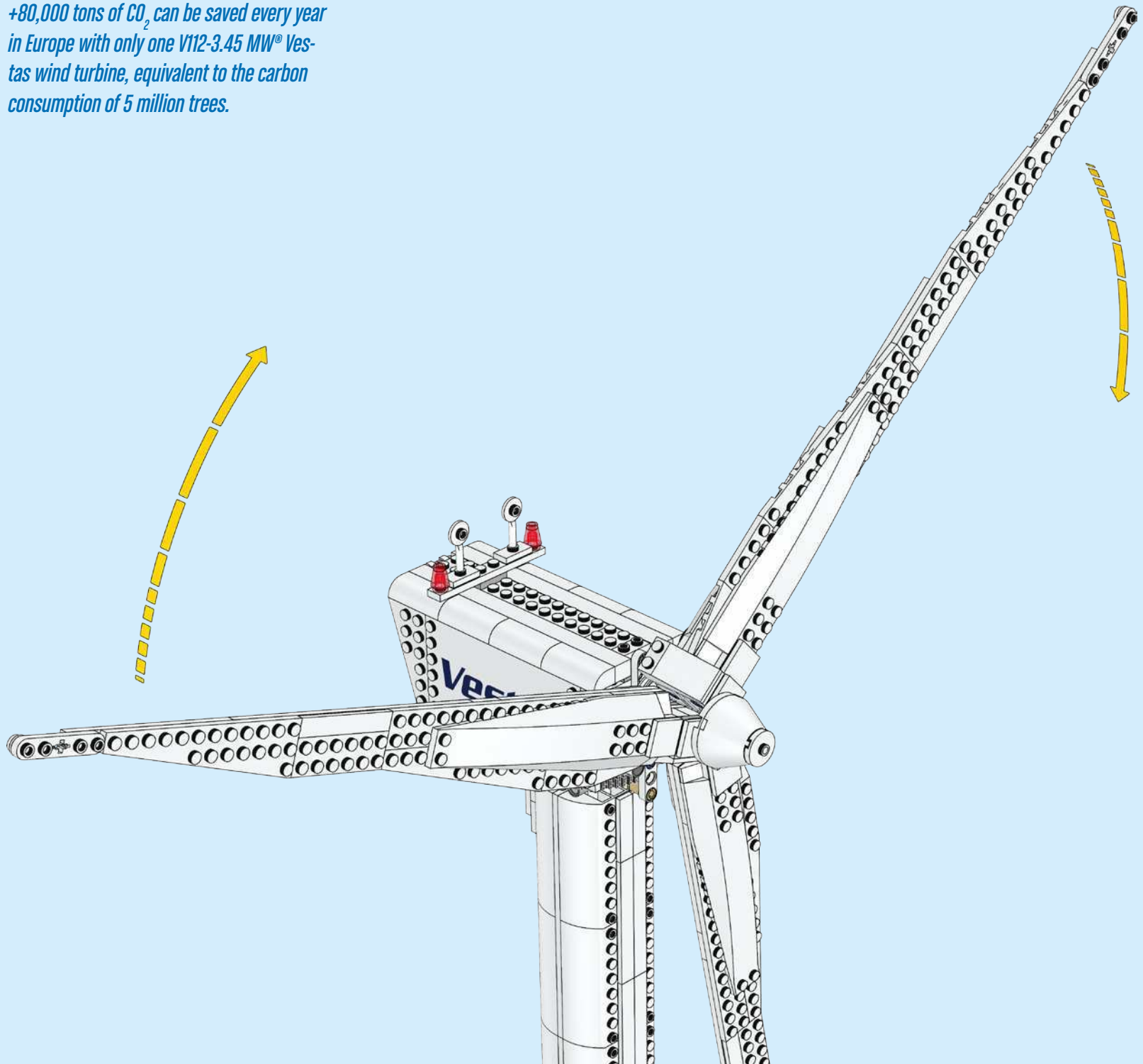

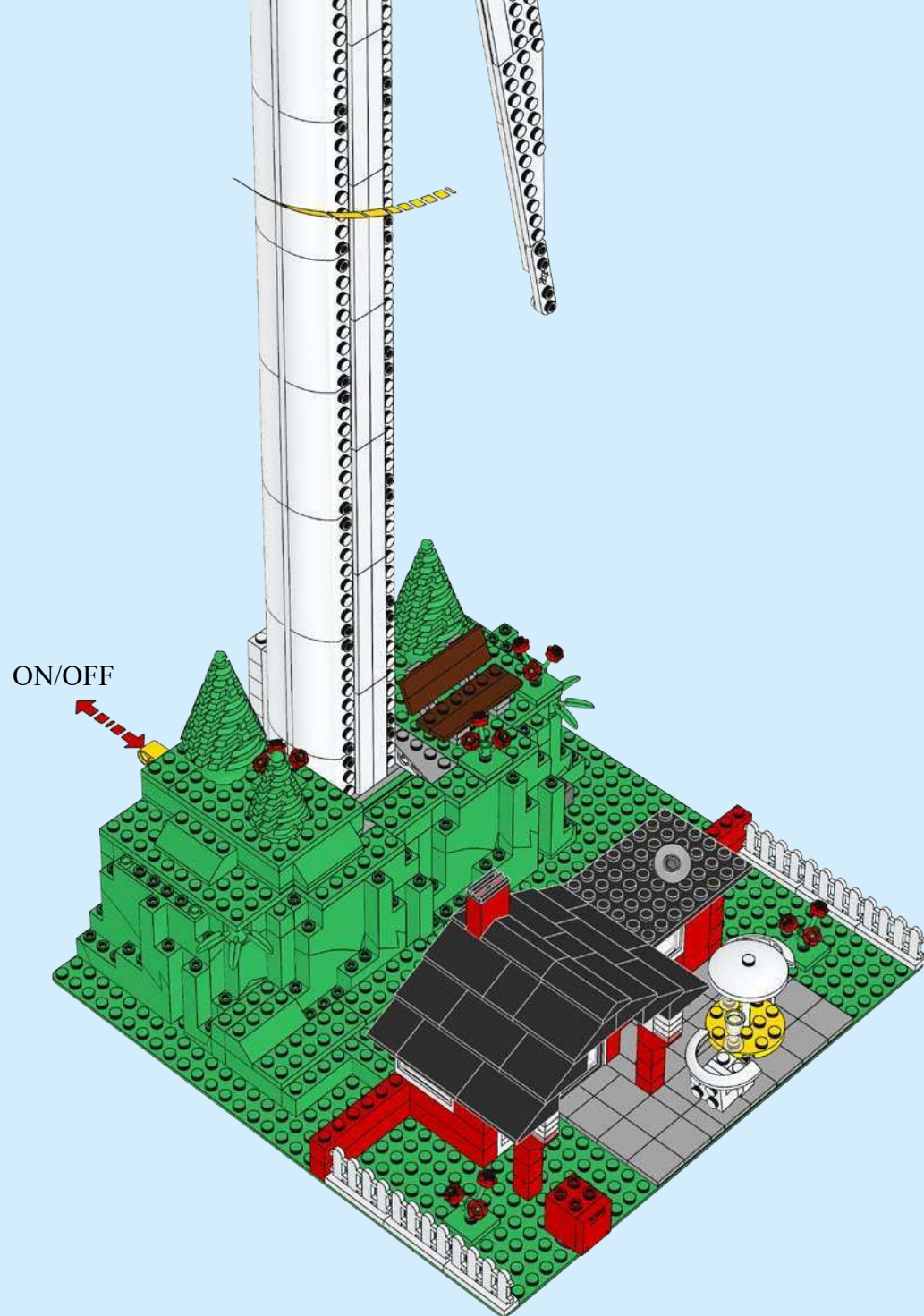

On/off
An/Aus
Marche/arrêt
On/off
Encendido/apagado
Ligado/Desligado
Be/ki
Leslēgt/izslēgt
开/关
Hidup/mati
Buka/Tutup



CREATOR™



[LEGO.com/creatorexpert](https://www.lego.com/creatorexpert)



EXPERT



10260

3x
614101



1x
6170419



6x
4504369



7x
302401



6x
407001



2x
654101



4x
300501



2x
623101



3x
4160857



2x
434601



2x
4173670



3x
4278271



1x
474001



1x
6093053



2x
614301



9x
3200001



2x
6146215



4x
6051511



10x
370001



7x
300401



2x
4521848



6x
366501



6x
6117940



1x
4506667



1x
4556152



1x
4287707



1x
4287708



6x
4208987



7x
302201



1x
300301



4x
302301



1x
306901



4x
6061024



2x
390001



1x
6173194



6x
306801



2x
4506668



1x
6198486



2x
434501



1x
4208160



1x
4179580



2x
4249112



6x
302101



6x
4259940



6x
4141607



2x
301001



7x
371001



2x
4143254



4x
243101



8x
370101



2x
6249999



2x
4558208



1x
4541956



1x
6250170



3x
4530590



1x
4515347



1x
396001



1x
6108662



3x
4527839



8x
608101



14x
302001



3x
4143000



4x
4249021



1x
329701



27x
366601



8x
663601



2x
6176554



9x
379501



3x
4261693



1x
4261565



7x
4582543



1x
346001



16x
416201



5x
303201

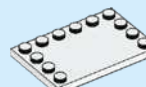

1x
4163986



9x
303401

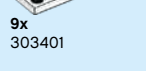

2x
4144012



8x
447701

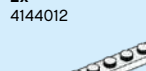

9x
6247197

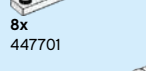

9x
6247198



1x
4503008



1x
244501



3x
4168072



2x
6250011



2x
246501



14x
4119227



3x
6192347

5

- 4x 4190219
- 1x 4521851
- 2x 6146217
- 4x 4143832
- 2x 366521
- 11x 4212414
- 1x 4261628
- 1x 6242131
- 1x 6089576
- 6x 301021
- 6x 300921
- 2x 300821
- 1x 303621
- 2x 306223
- 1x 459923
- 12x 4143005
- 5x 4613257
- 2x 6013938
- 1x 6084724
- 1x 4666999
- 15x 6206148
- 9x 300521
- 4x 4206482
- 1x 9566
- 13x 4514553
- 1x 407923
- 1x 317623
- 1x 4212411
- 2x 306224
- 1x 6154803
- 1x 4651443
- 1x 6112629
- 1x 4256320
- 1x 4632569
- 1x 306924
- 2x 362224
- 2x 6249535
- 1x 6192763
- 1x 4515349
- 2x 389424
- 1x 4495934
- 1x 73737
- 1x 6247194
- 1x 459926
- 6x 4504382
- 1x 4177431
- 1x 4517925
- 1x 6051508
- 1x 403226
- 42x 4121715
- 1x 452826
- 1x 249626
- 5x 241226
- 3x 302326
- 6x 4107761
- 2x 4173970
- 4x 4568644
- 4x 6092658
- 5x 6254808
- 1x 6253332
- 4x 329826
- 4x 416126
- 10x 329726
- 1x 379526
- 1x 303326
- 1x 6030875
- 1x 6109283
- 1x 6096955
- 1x 370826
- 2x 4529155
- 1x 4211366
- 1x 4244627
- 2x 4211803
- 26x 4211413
- 1x 4211387
- 2x 4211804
- 2x 4515369
- 4x 6183784
- 2x 4211566
- 2x 4211613
- 15x 4211445
- 2x 4211639
- 2x 4262978
- 1x 6109285
- 2x 4211732
- 2x 4211735
- 4x 4211764
- 1x 4211512
- 22x 4211398
- 6x 4211414
- 2x 4211503
- 1x 4211622
- 1x 4255629

5

12

7



1x
6245192



2x
6249854



2x
4162916



3x
4211204



4x
4221590



2x
6166107



2x
6245250



6x
6252041



1x
6256058



3x
6253734



1x
4614195



2x
6172226



2x
6240212



1x
6240515



1x
6238674

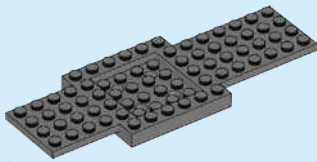

1x
6249995



2x
6012451



1x
4289542



2x
4210469



1x
6133119



2x
4211105



1x
4211064

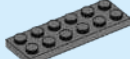

1x
4211002

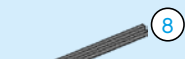

2x
4499858



5x
4210998



1x
6093516



1x
6104570



5x
6135278



5x
4565321



1x
302228



2x
4114348



5x
4112838



9x
243128



3x
4141737

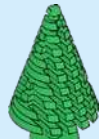

2x
347128



2x
302028



6x
379528



2x
6249998



1x
4507311



2x
6247196

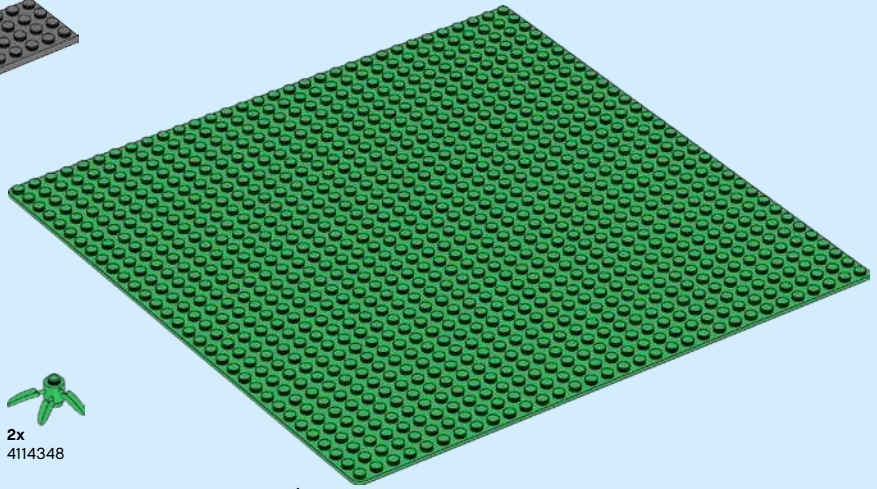

1x
4219692

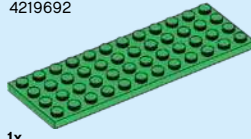

1x
4279059



3x
4125281



3x
300328



1x
243528

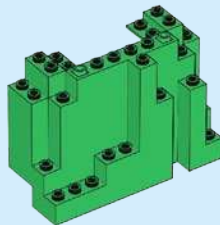

4x
6247195

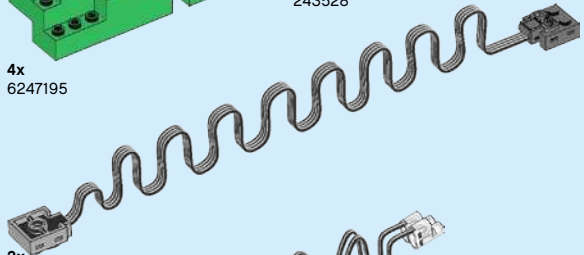

2x
6209890

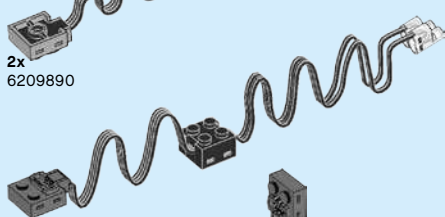

1x
6234560

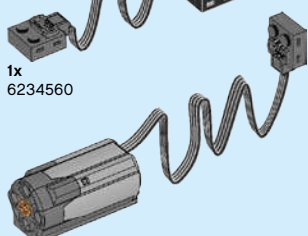

1x
6209881

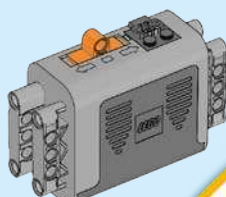

1x
6257768

Customer Service
Kundenservice
Service Consommateurs
Servicio Al Consumidor

LEGO.com/service or dial



: 00800 5346 5555

: 1-800-422-5346

WIN

GO TO WWW.LEGO.COM/PRODUCTFEEDBACK
AND GIVE US YOUR SHORT **FEEDBACK**
ABOUT THIS LEGO® SET FOR A CHANCE
TO WIN A COOL LEGO PRIZE.

Terms & Conditions apply



LEGO.com/productfeedback

GEWINNE

Erzähle uns auf
www.LEGO.com/productfeedback

etwas über die Erfahrungen, die du mit
diesem LEGO® Set gemacht hast, und
sichere dir die Chance auf einen coolen
LEGO Preis!

Es gelten die Teilnahmebedingungen

GAGNE

Rends-toi sur
www.LEGO.com/productfeedback

et donne-nous quelques commentaires
sur ce produit LEGO® pour avoir une
chance de gagner un prix LEGO !

Voir Conditions Générales

GANAN

Visita
www.LEGO.com/productfeedback

y envíanos tu opinión acerca de este
set LEGO®. ¡Participarás en el sorteo
de un premio LEGO!

Términos y Condiciones aplicables

获取奖品

登录
www.LEGO.com/productfeedback

给出关于此乐高®套装的简短反馈，
就有机会获得炫酷乐高奖品

《条款及条件》适用

경품 당첨 기회

www.LEGO.com/productfeedback

페이지로 이동하여 이 레고® 세트에 대한
간략한 피드백을 보내 주시고 멋진 레고
경품을 탈 수 있는 기회도 잡으십시오

약관 적용

ЗАПОЛНИ АНКЕТУ И ПОЛУЧИ ПРИЗ

Перейди по ссылке
www.LEGO.com/productfeedback

ответь всего на несколько вопросов
об этом наборе LEGO®, и у тебя появ-
ится шанс выиграть замечательный
приз от компании LEGO.

Применяются Условия и правила
участия