



BRICK 'HEADZ

41621



Harry Potter



[LEGO.com/brickheadz](https://www.LEGO.com/brickheadz)

RON WEASLEY™

60



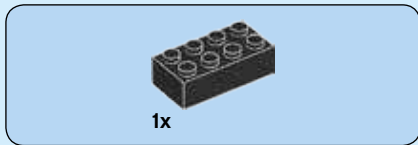

1

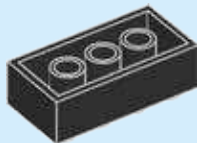



1x



2x

2

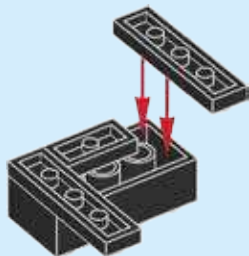

4



2x



1x

3

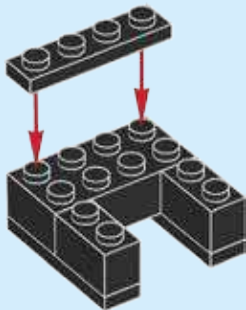
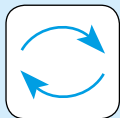



1x

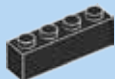

1x

4

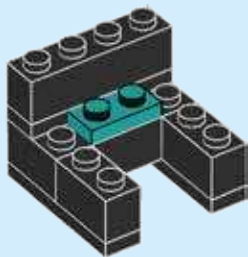

6

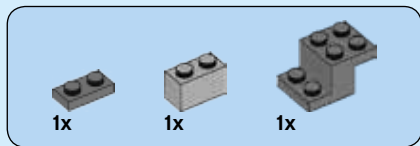

5

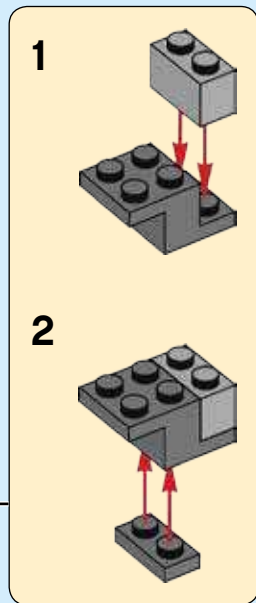
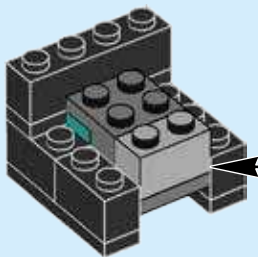



2x

6

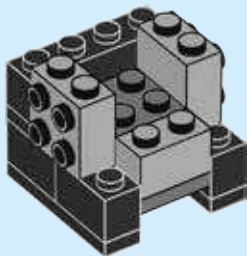

8



7

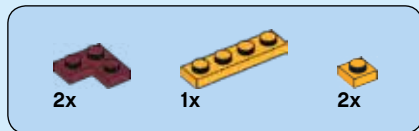
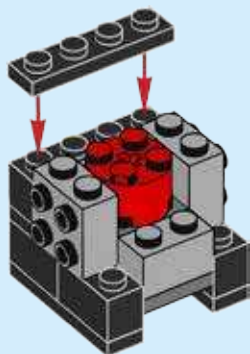

8

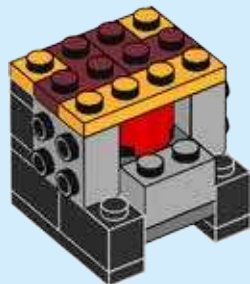



2x



1x

9



10



1x



2x



2x

10



1x



2x

11

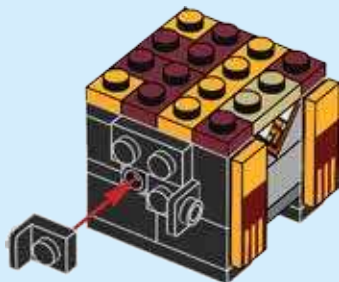



1x



2x

12

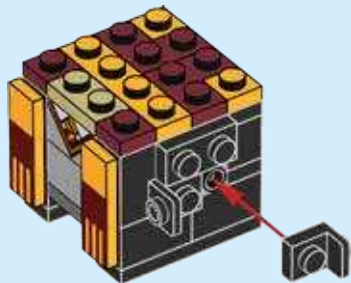
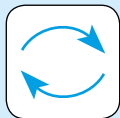

12



13

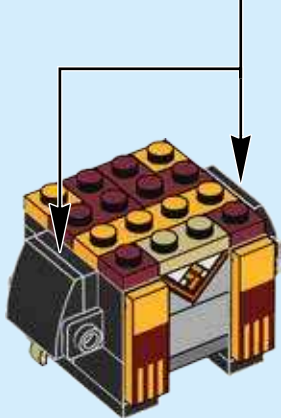
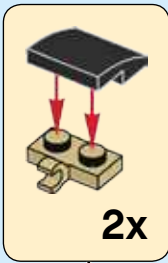
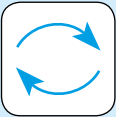



6x

14

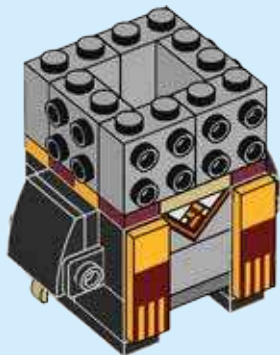

14



15

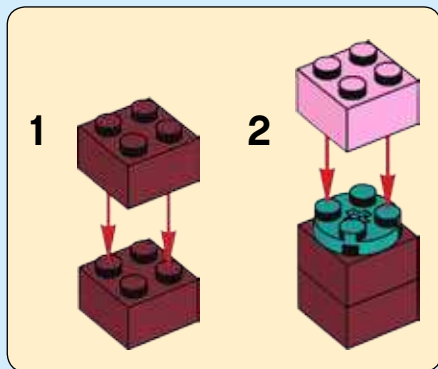



6x

16

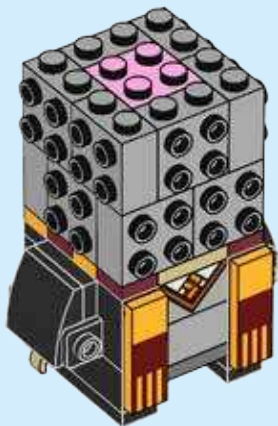

16



1x



2x

17

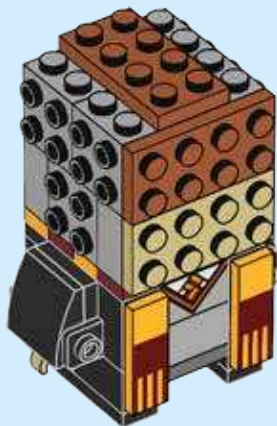



1x



1x

18

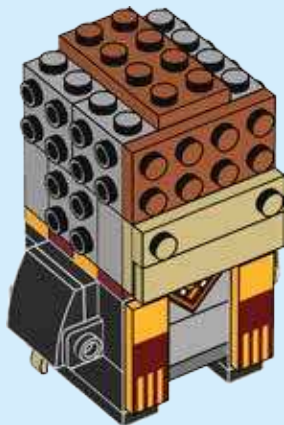



1x



1x



2x

19

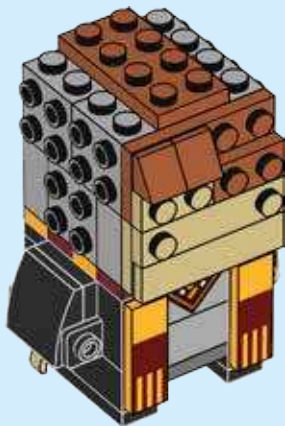



1x



2x



2x

20

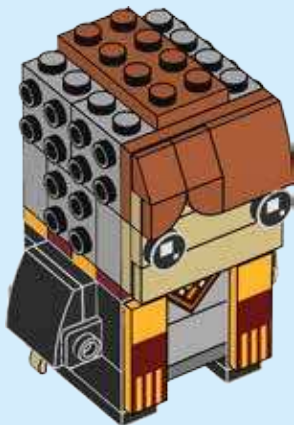

20



1x



1x



2x

21

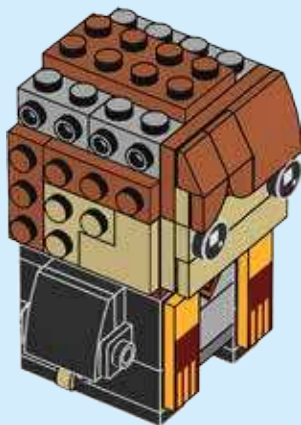



1x



2x



1x



1x

22

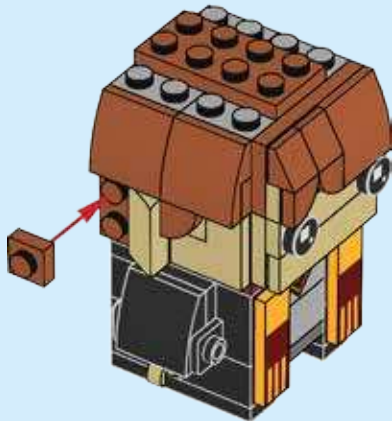

22



23

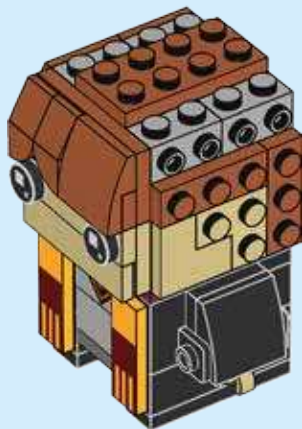
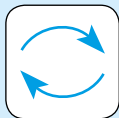



1x



2x



1x



1x

24

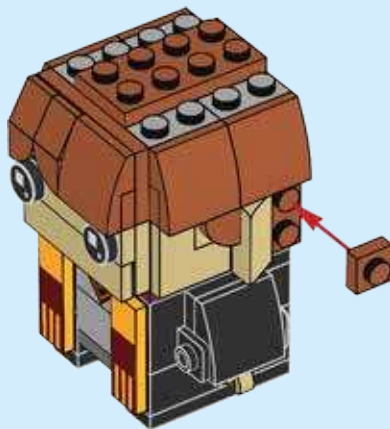



2x

25

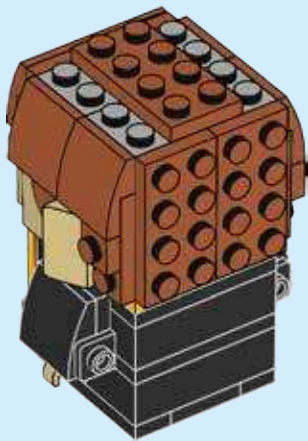
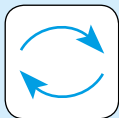



1x

26

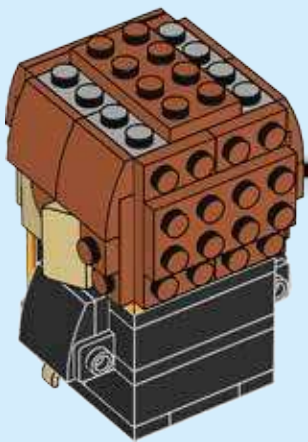

26



4x

27

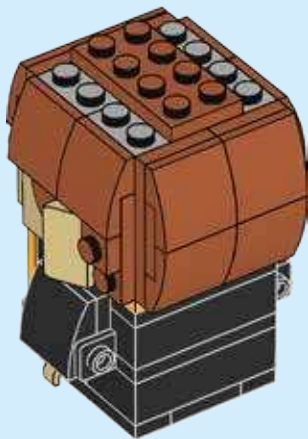



2x



2x

28

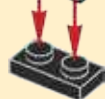
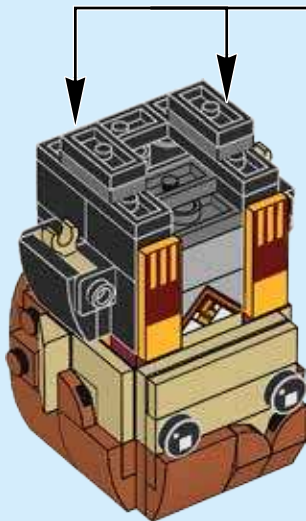
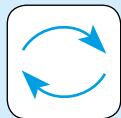

2x



29

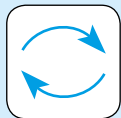

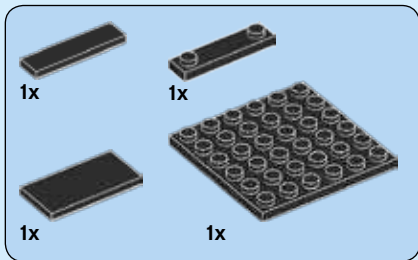

30

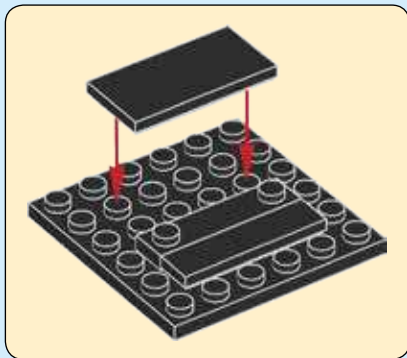

30

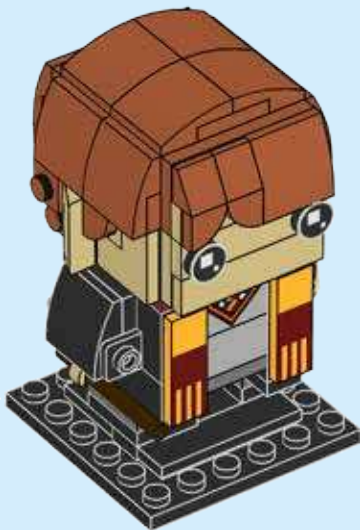



BRICK HEADZ

Harry Potter

41615

41615

41616

41621

41621



49 HARRY POTTER™



50 HEDWIG™



51 HERMIONE GRANGER™



60 RON WEASLEY™



61 ALBUS DUMBLEDORE™



WIN

GO TO WWW.LEGO.COM/PRODUCTFEEDBACK AND
GIVE US YOUR SHORT **FEEDBACK** ABOUT THIS
LEGO® SET FOR A CHANCE TO WIN
A COOL LEGO PRIZE.

Terms & Conditions apply

LEGO.com/productfeedback

GEWINNE

Erzähle uns auf
www.LEGO.com/productfeedback

etwas über die Erfahrungen, die du
mit diesem LEGO® Set gemacht hast,
und sichere dir die Chance auf einen
coolen LEGO Preis!

Es gelten die Teilnahmebedingungen

GAGNE

Rends-toi sur
www.LEGO.com/productfeedback

et donne-nous quelques commen-
taires sur ce produit LEGO® pour
avoir une chance de gagner un
prix LEGO !

Voir Conditions Générales

GANAN

Visita
www.LEGO.com/productfeedback

y envíanos tu opinión acerca de este
set LEGO®. ¡Participarás en el sorteo
de un premio LEGO!

Términos y Condiciones aplicables

获取奖品

登录
www.LEGO.com/productfeedback

给出关于此乐高®套装的简短反馈，
就有机会获得炫酷乐高奖品

《条款及条件》适用

LEGO and the LEGO logo are trademarks of the LEGO Group. ©2018 The LEGO Group.

© 2018 WBEI
Publishing Rights © J.K.R.
TM J.K.R. & WBEI

6247392