



# NEXO KNIGHTS



 [LEGO.com/nexoknights](http://LEGO.com/nexoknights)

70319



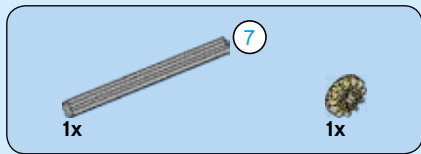

# 31

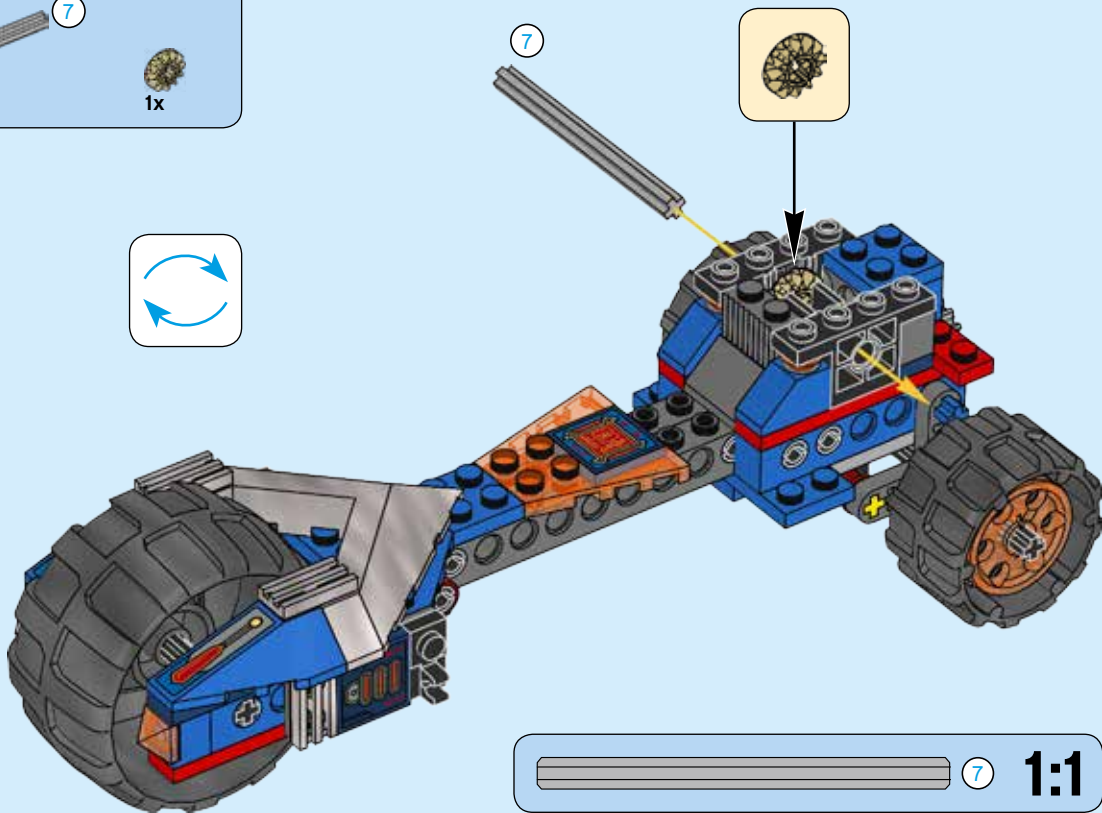
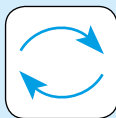



2x

# 32

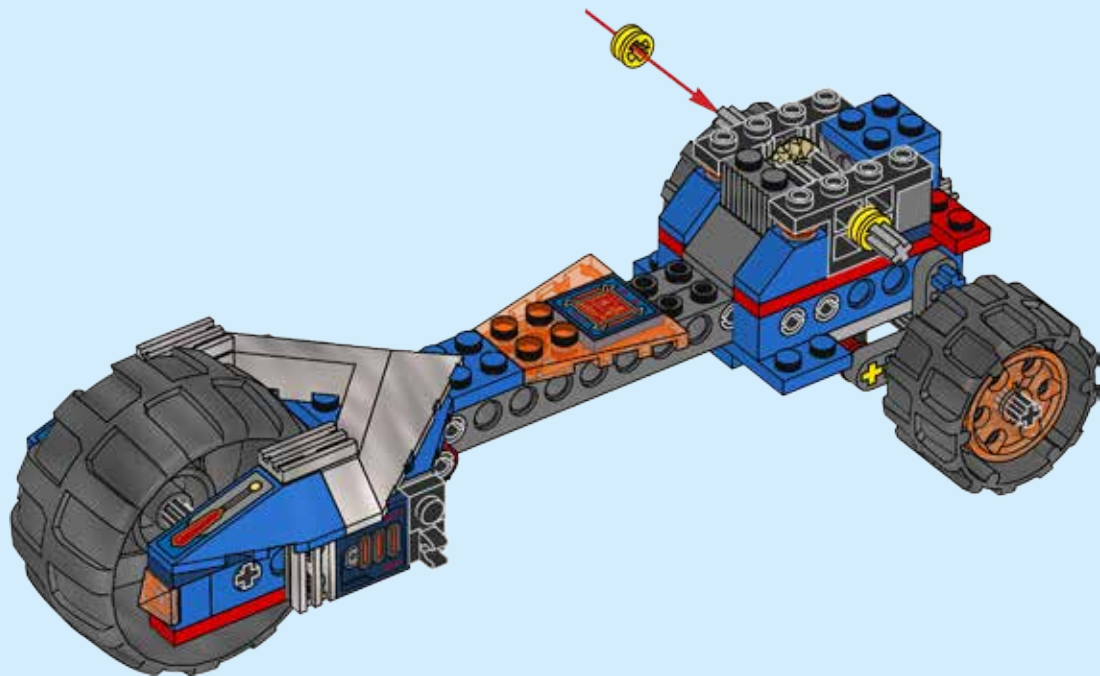

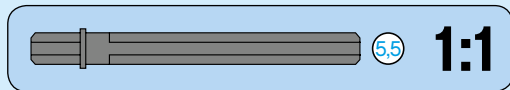
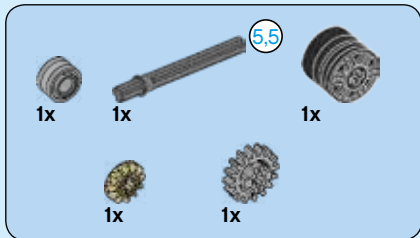

# 33

## 1

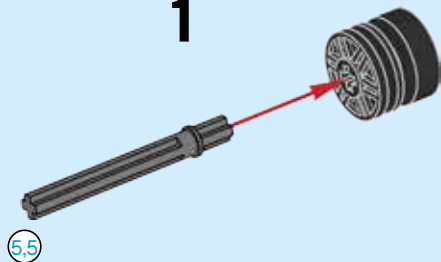

## 2

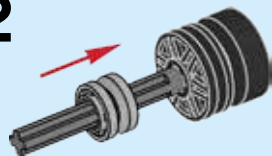

## 3

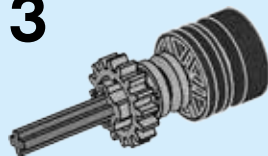

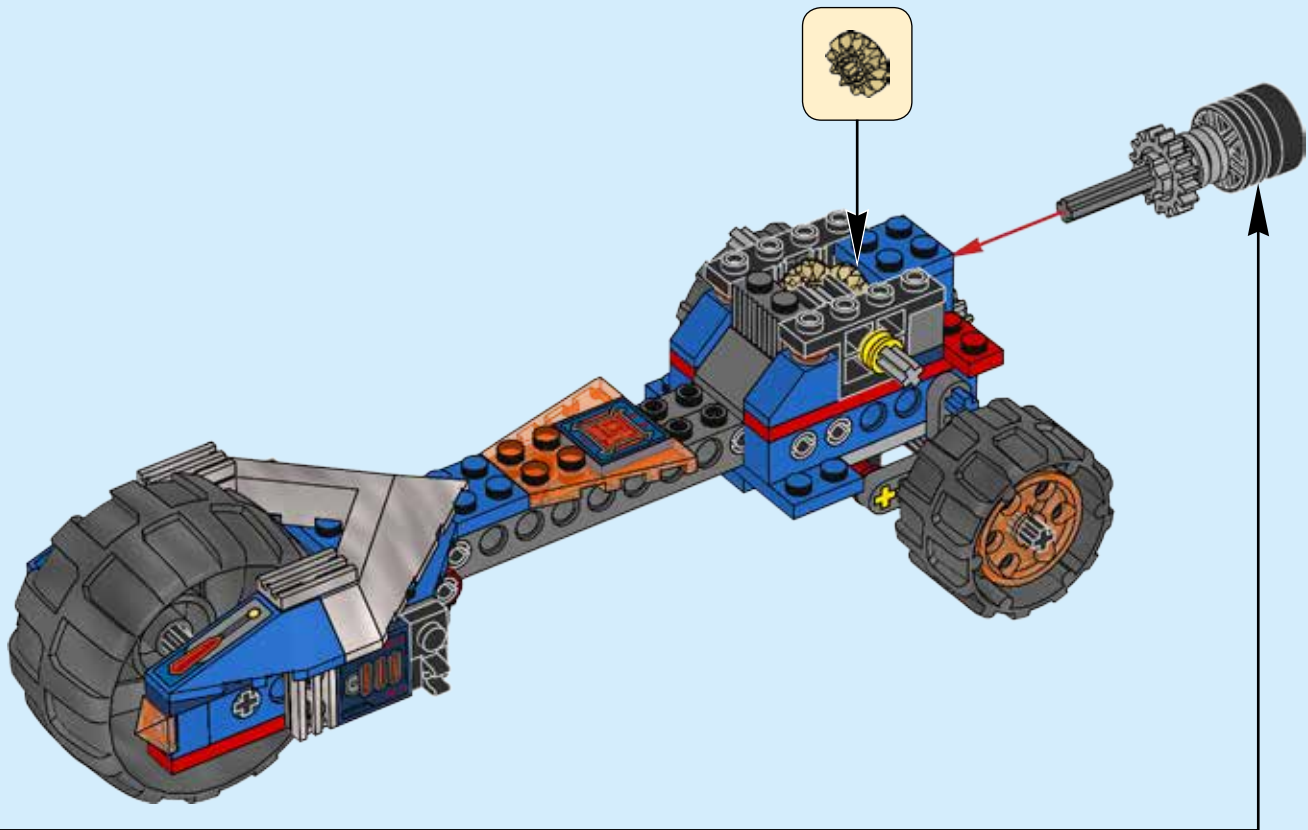

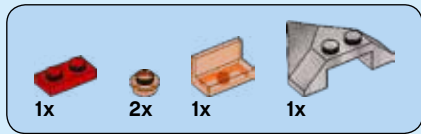

34

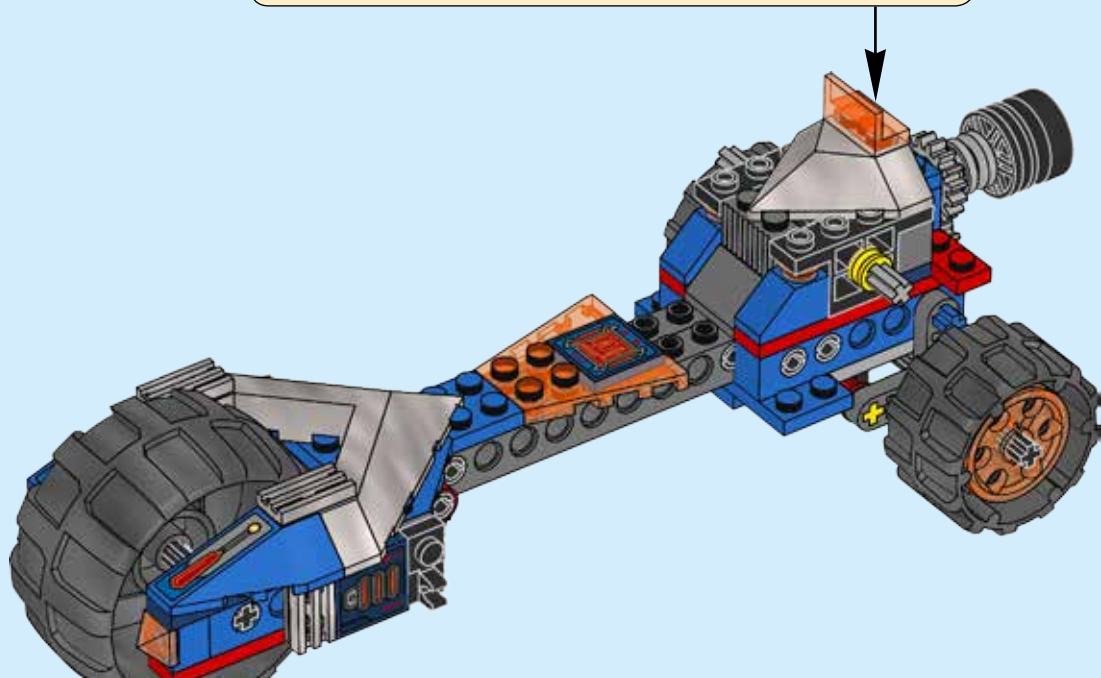

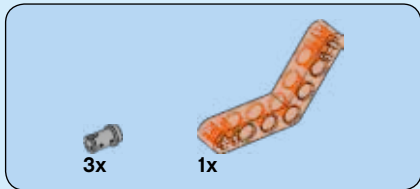

35

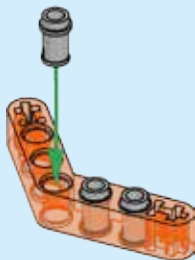

36

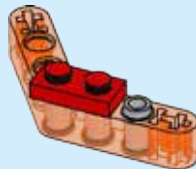



1x

# 37

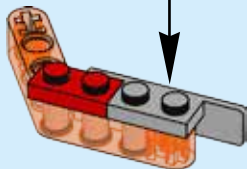
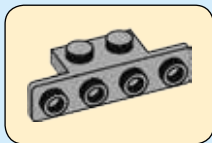

1x

# 38

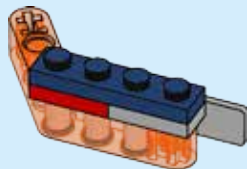



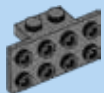

1x

# 39

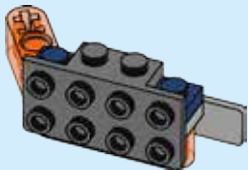

1x

# 40

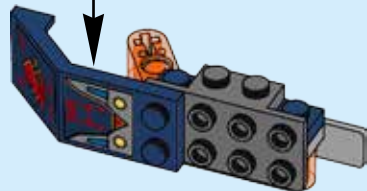
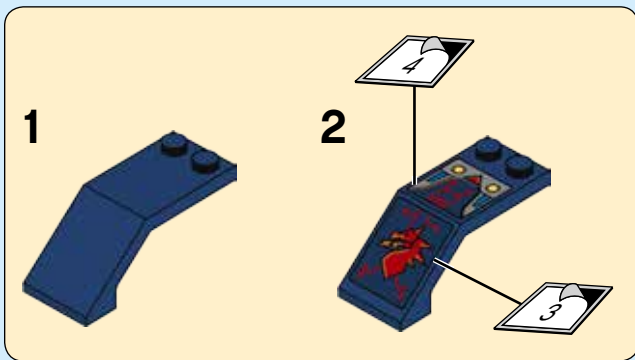



41

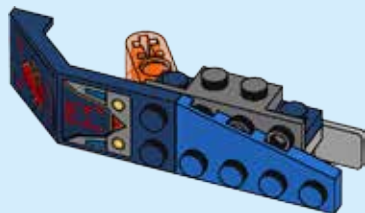

42

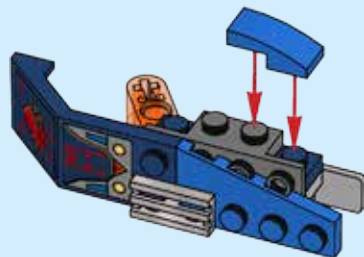

43

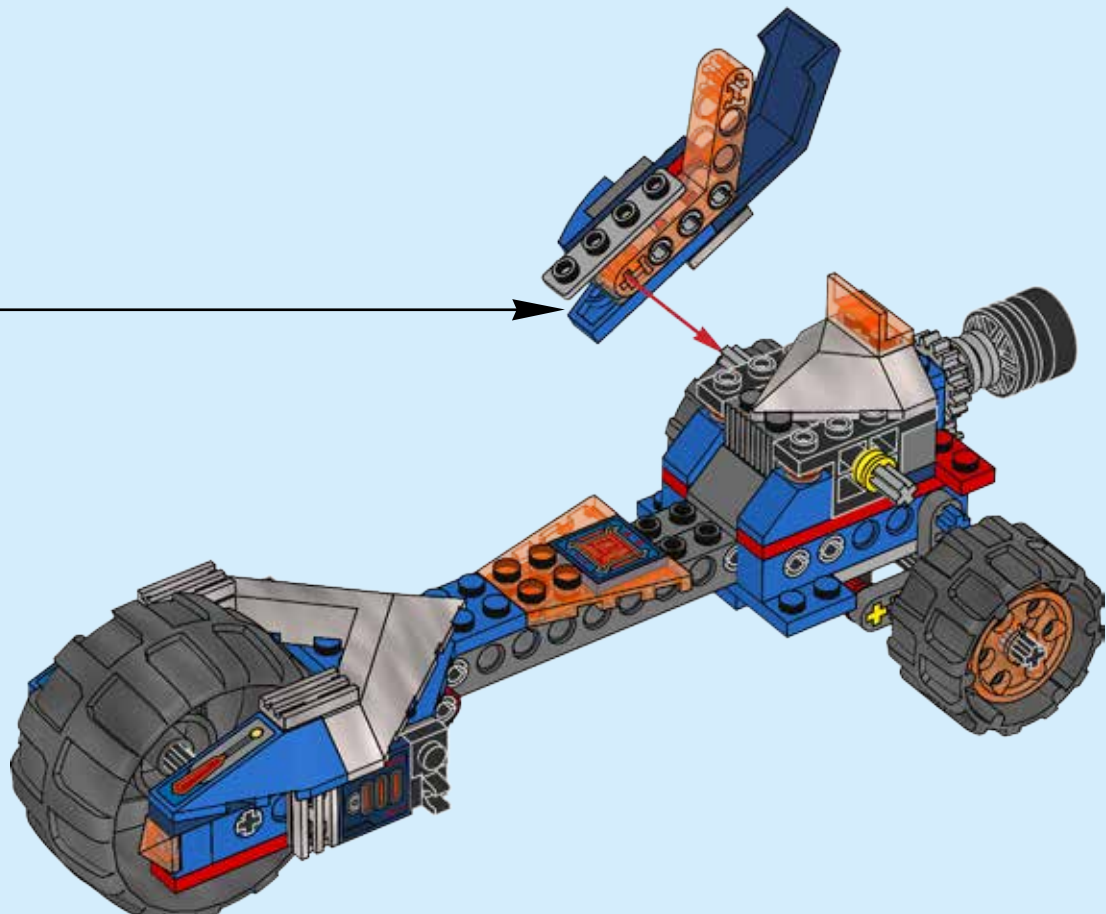

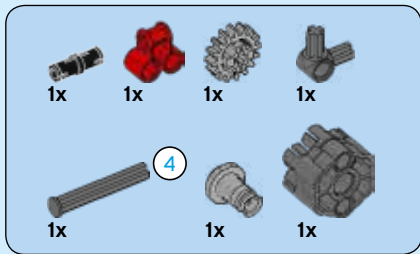

# 44

## 1

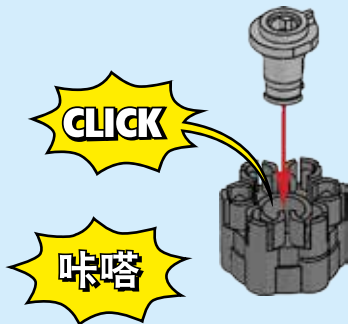

## 2

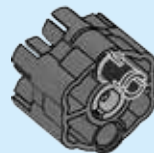
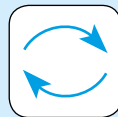

## 3



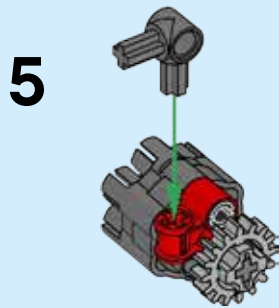
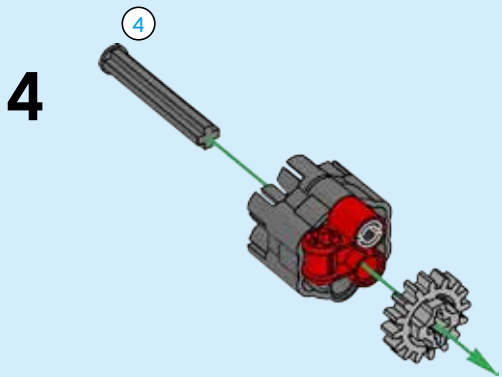
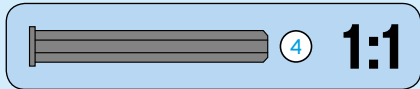

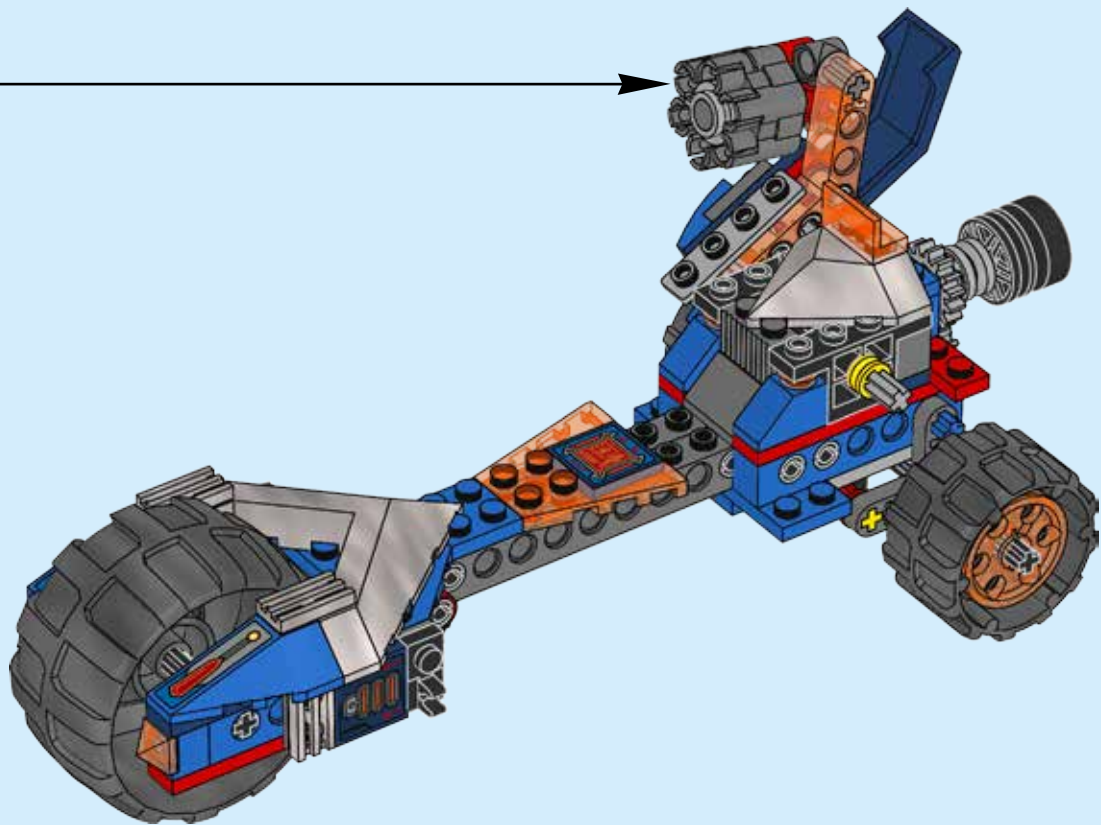

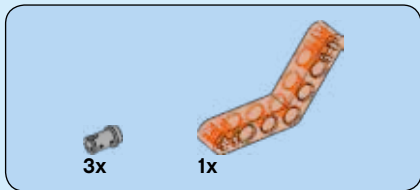

45

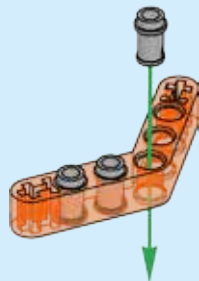

46

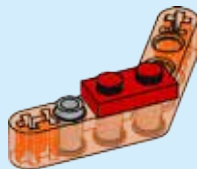



1x

# 47

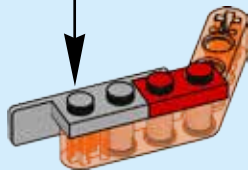
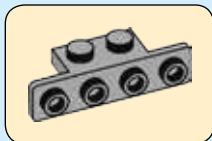

1x

# 48

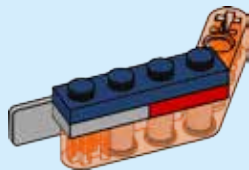



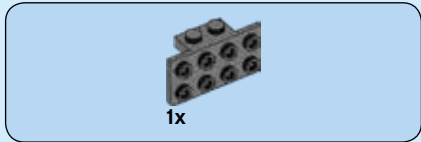

49

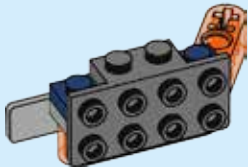

50

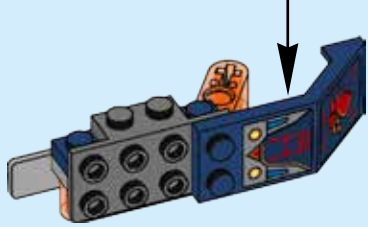
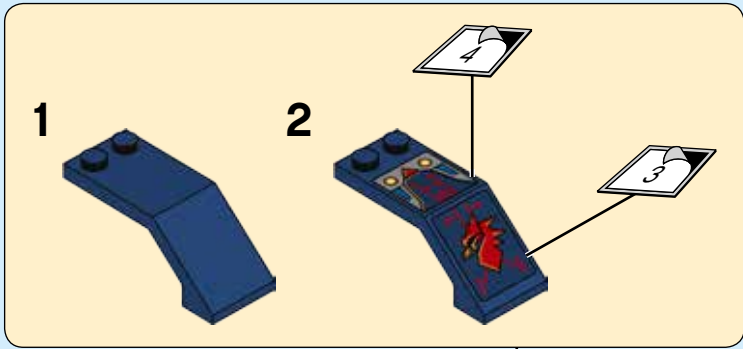



1x

# 51

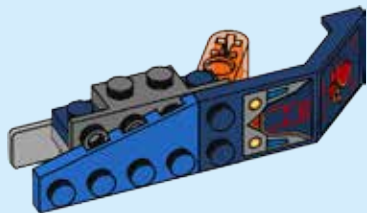

1x



1x

# 52

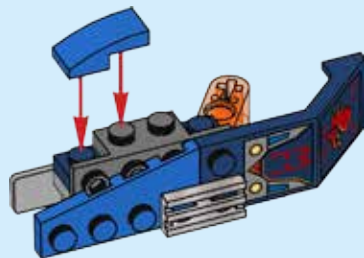

53

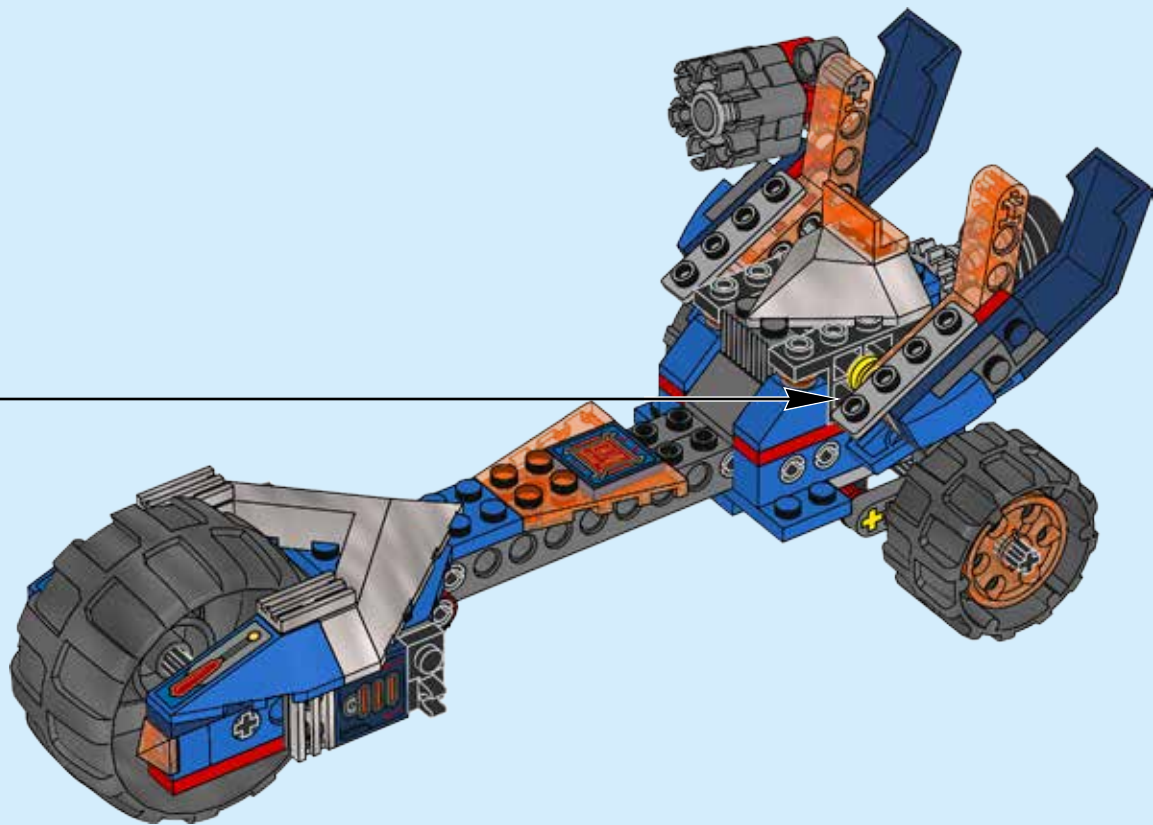

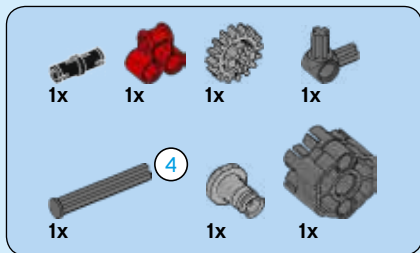

# 54

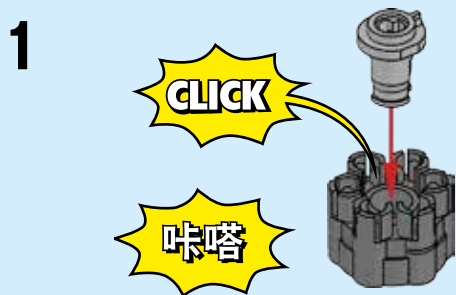

2

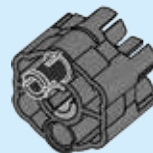
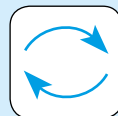

3

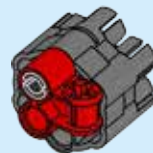

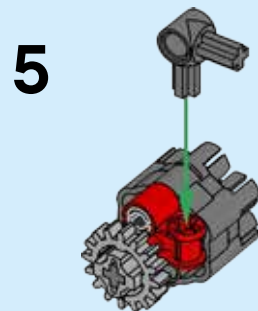
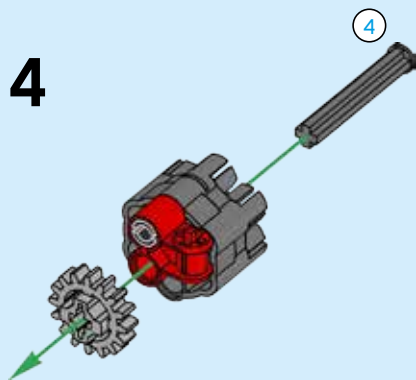
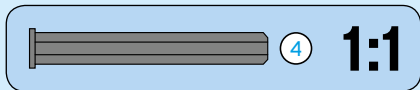

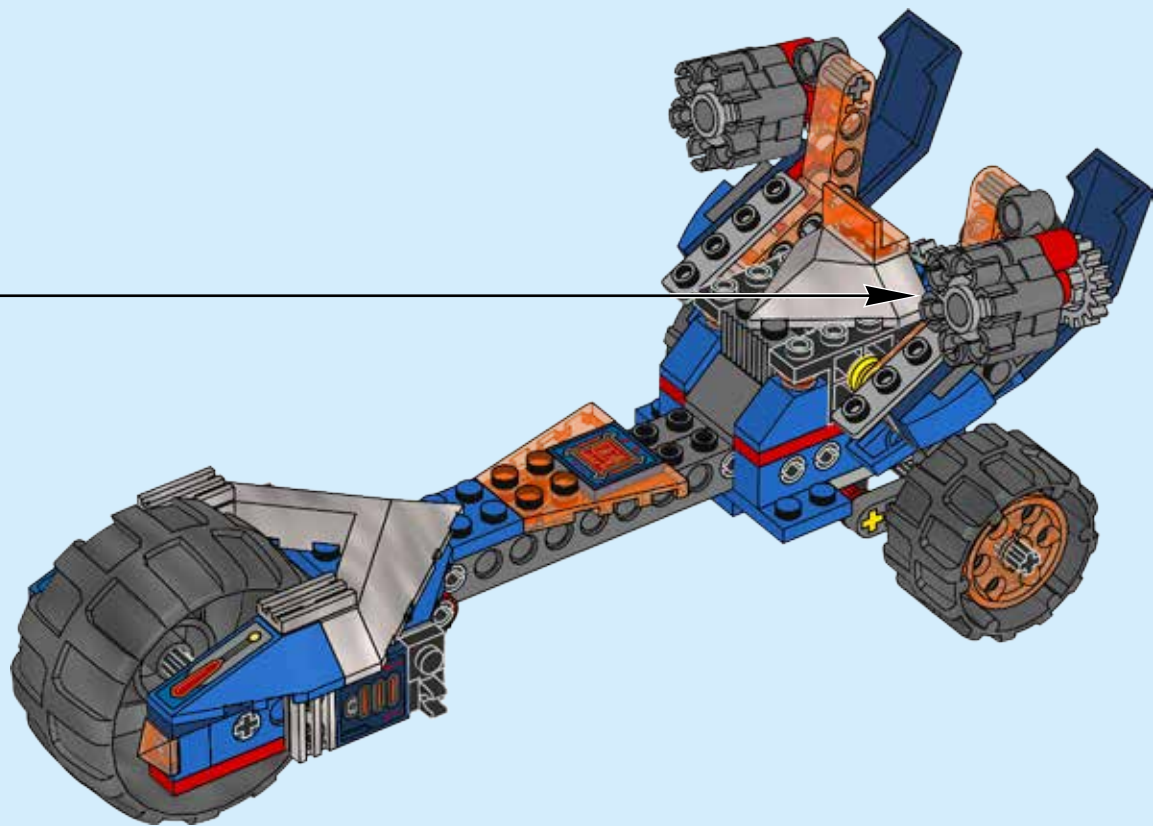

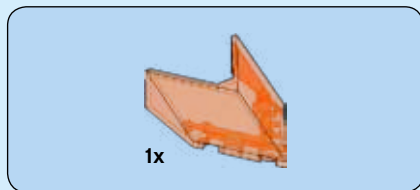

55

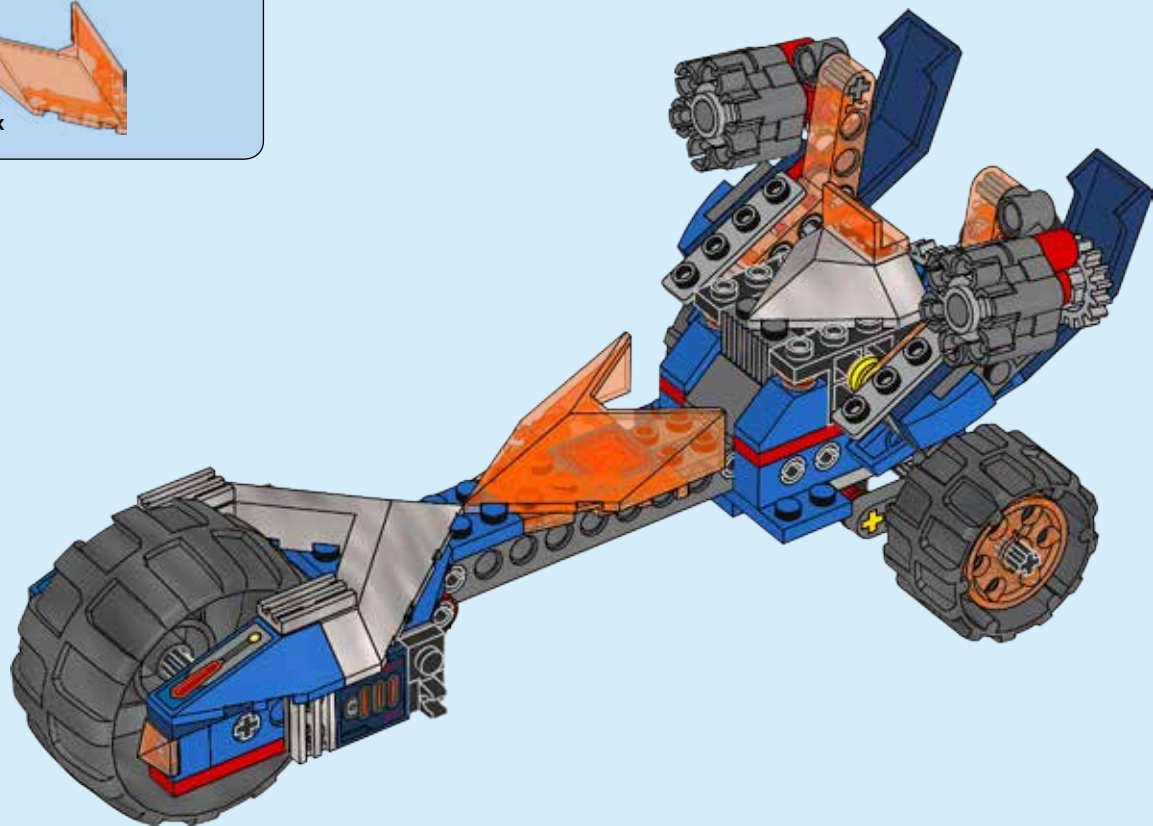



24x



# 56





57

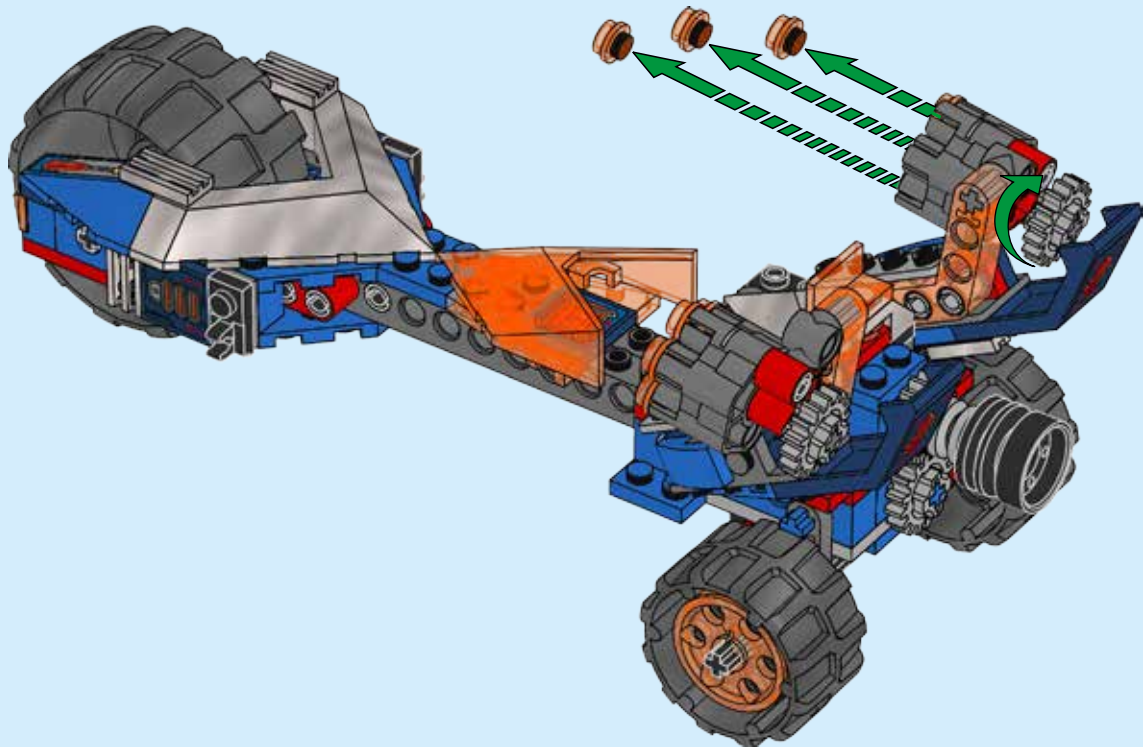
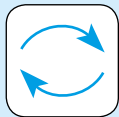

58

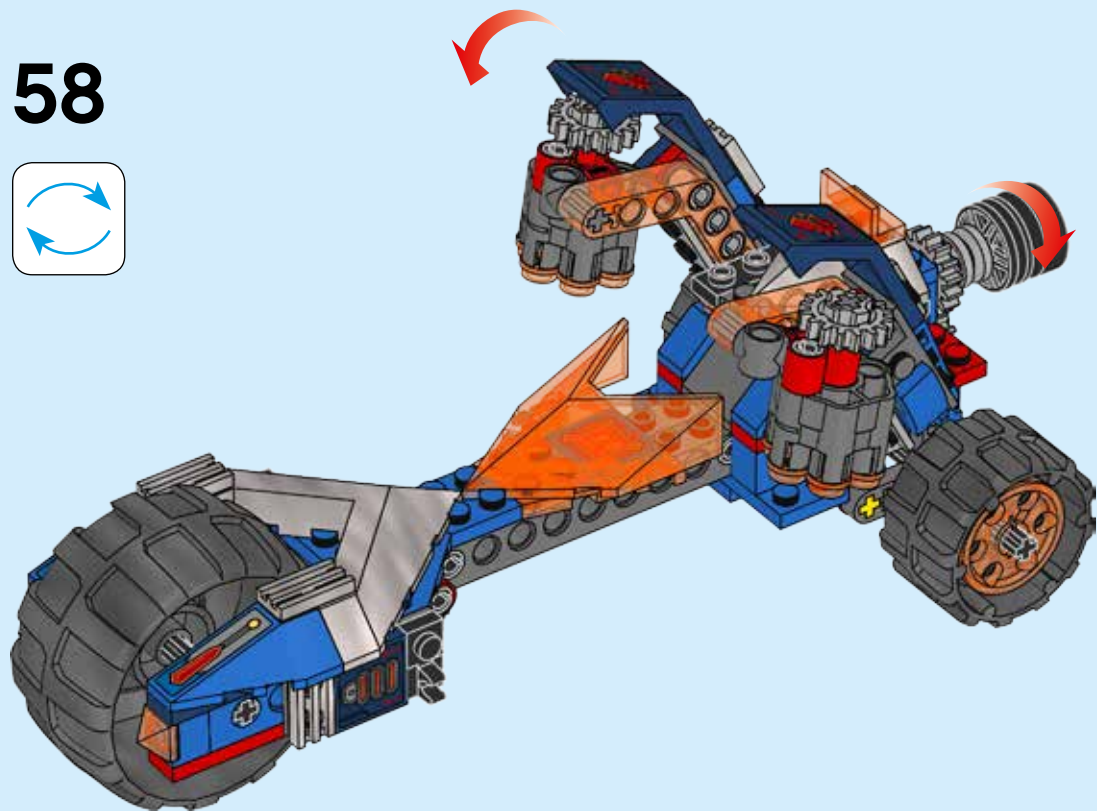
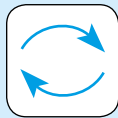

59

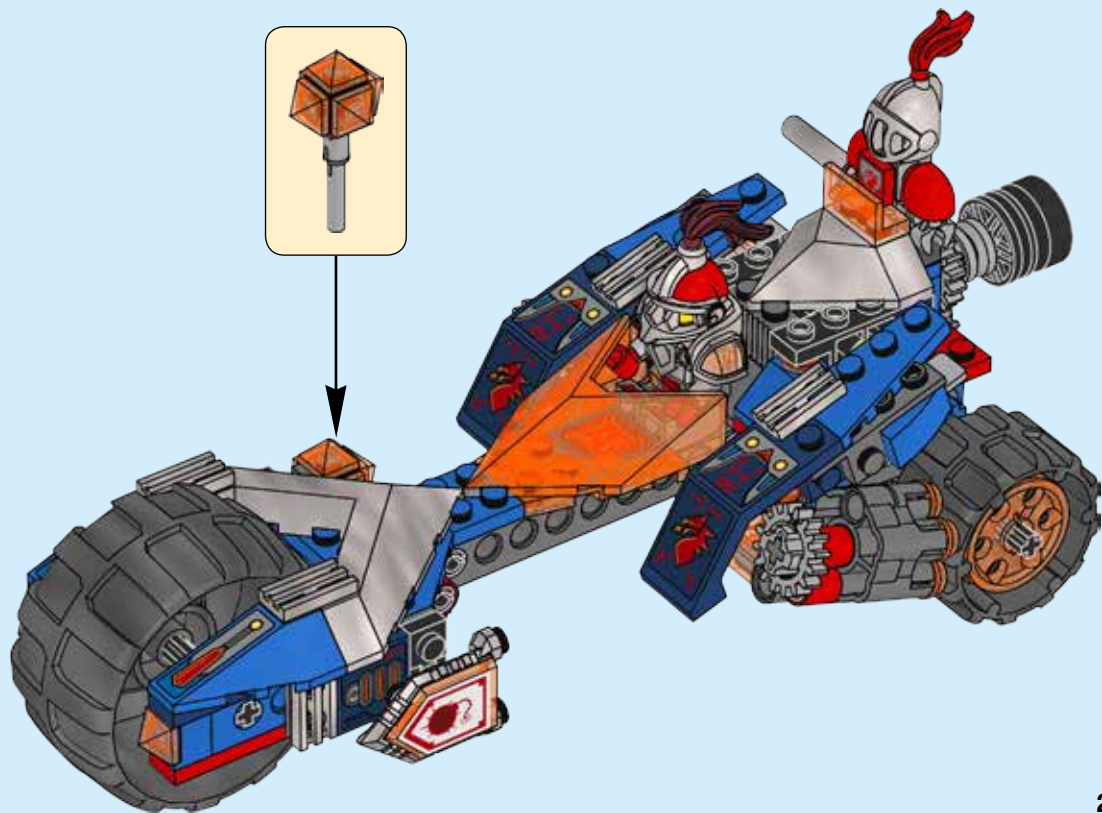



2x  
4565452



2x  
6129170



1x  
6129763



1x  
6125422



4x  
4227155



1x  
4540552



1x  
4298617



1x  
6102138



4x  
302321



2x  
4128594

**28**



2x  
4153718



5x  
366621



1x  
6124855



1x  
6129794



2x  
407023



1x  
4161330



1x  
4160867



3x  
4206482



2x  
6055065



2x  
370023



2x  
4121936



2x  
302223



1x  
4622179



1x  
4622180



2x  
241923



4x  
389423



2x  
379523



4x  
4239601



1x  
6124848



1x  
403224



1x  
6130008



14x  
4121715



1x  
4226000



1x  
370626



2x  
4598528



1x  
370826

5

6

12



2x  
4233487



1x  
4517737



1x  
6133716



1x  
4500902



28x  
3005747



7x  
6127035



1x  
6127431



1x  
6131739



2x  
6124680



1x  
6124831



1x  
6129592



2x  
6102900



3x  
4205004



5x  
4502089



2x  
6130061



2x  
4542590



6x  
4211483



1x  
4211758



1x  
6129994



2x  
6097090



4x  
4640536



1x  
4520320



2x  
6014615



1x  
4243797



1x  
4211805



1x  
6134219



1x  
6129791



1x  
6124857



1x  
4210700



2x  
6005331



1x  
4210636



2x  
4210659



1x  
4211054



2x  
6100488



2x  
6100488



2x  
6100488



2x  
6100488



4x  
6118832



2x  
6083620



1x  
4213607



1x  
4508553



1x  
6129662



1x  
6125711



1x  
6128617



1x  
6128617



1x  
6128617



1x  
6128617



1x  
6125244



6x  
4619636



1x  
6129534



1x  
6129534



1x  
6020190



1x  
6129453



1x  
6129453



2x  
4611882



1x  
6131743



2x  
6125856



2x  
6122170



2x  
6122170



2x  
6122170



1x  
6120917



1x  
6120917



**Customer Service**

**Kundenservice**

**Service Consommateurs**

**Servicio Al Consumidor**

**LEGO.com/service or dial**



**: 00800 5346 5555**

**: 1-800-422-5346**



# NEXO KNIGHTS™



DOWNLOAD  
THE FREE APP



LEGO® NEXO KNIGHTS™: MERLOK 2.0



1



2



3

DOWNLOAD THE FREE APP/KOSTENLOSE APP HERUNTERLADEN/TÉLÉCHARGE L'APPLI GRATUITE  
DESCARGA LA APP GRATIS/DESCARREGA A APP GRÁTIS/TÖLTSD LE AZ INGYENES APPOT!/下载免费 APP

DEVICE CHECK:/GERÄT PRÜFEN;/VERIFICATION DE COMPATIBILITÉ :  
COMPRUEBA TU DISPOSITIVO:/VERIFICAÇÃO DO DISPOSITIVO;/ESZKÖZELLENŐRZÉS:/设备检查:

[LEGO.com/devicecheck](http://LEGO.com/devicecheck)



# NEXO KNIGHTS

## SCANNING TIPS

Scanning Tips / Tipps zum Scannen / Conseils de scannage / Consejos para escanear  
Dicas para o scan / Beolvasási tippek / 扫描秘诀





# NEXO KNIGHTS™



## LEGOLAND



DOWNLOAD THE FREE APP://KOSTENLOS  
APP HERUNTERLADEN;/TELECHARGE L'APPLI  
GRATUITE ;/DESCARGA LA APP GRATIS;/  
DESCARREGA A APP GRATIS;/TÖLTSD LE AZ  
INGYENES APPTI;/ 下载免费 APP:

LEGO® NEXO KNIGHTS™: MERLOK 2.0

ALL MATERIALS MIGHT NOT BE AVAILABLE IN ALL MARKETS./  
MÖGLICHERWEISE IST NICHT DAS GANZE MATERIAL IN ALLEN  
MÄRKTEN VERFÜGBAR./CERTAINS PRODUITS PEUVENT NE PAS  
ÊTRE DISPONIBLES SUR CERTAINS MARCHÉS./CIERTOS MATERIALES  
PODRÍAN NO ESTAR DISPONIBLES EN TODOS LOS MERCADOS./OS  
MATERIAIS PODERÃO NÃO ESTAR TODOS DISPONÍVEIS EM TODOS  
OS MERCADOS./ELKÉPZELHETŐ, HOGY BIZONYOS KIEGÉSZÍTŐK A TE  
ORSZÁGODBAN NEM ELÉRHETŐEK./部分内容可能不适用于某些国家/地区

LEGO.COM/NEXOKNIGHTS



**LEGO** NEXO KNIGHTS™





# NEXO KNIGHTS







# club™

1



[LEGO.com/club](http://LEGO.com/club)

2



3

