

ELVES

41075

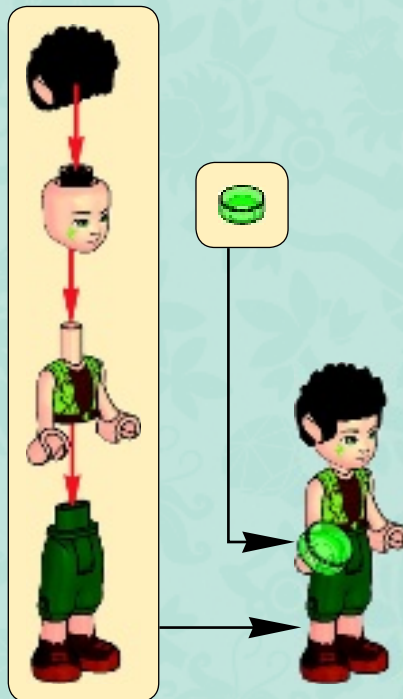

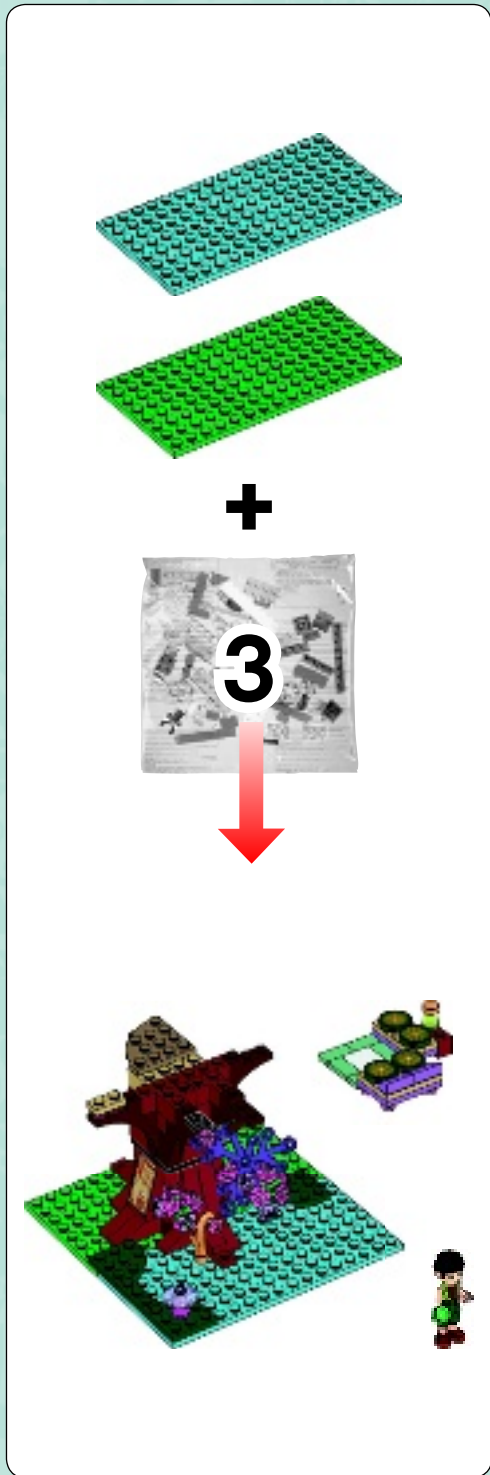

1x 1x 4x 6x

50





1x



1x



1x

51

1



2



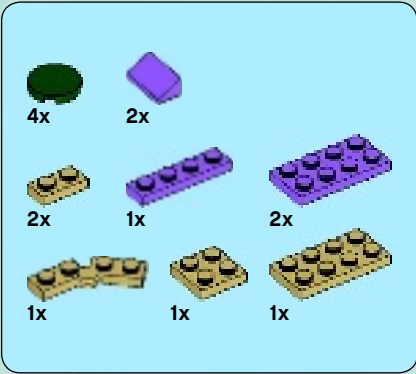

52

1

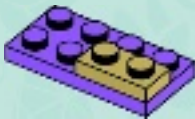

2



3



4



5



6



7

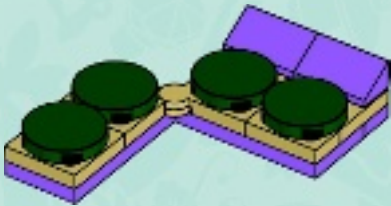

8

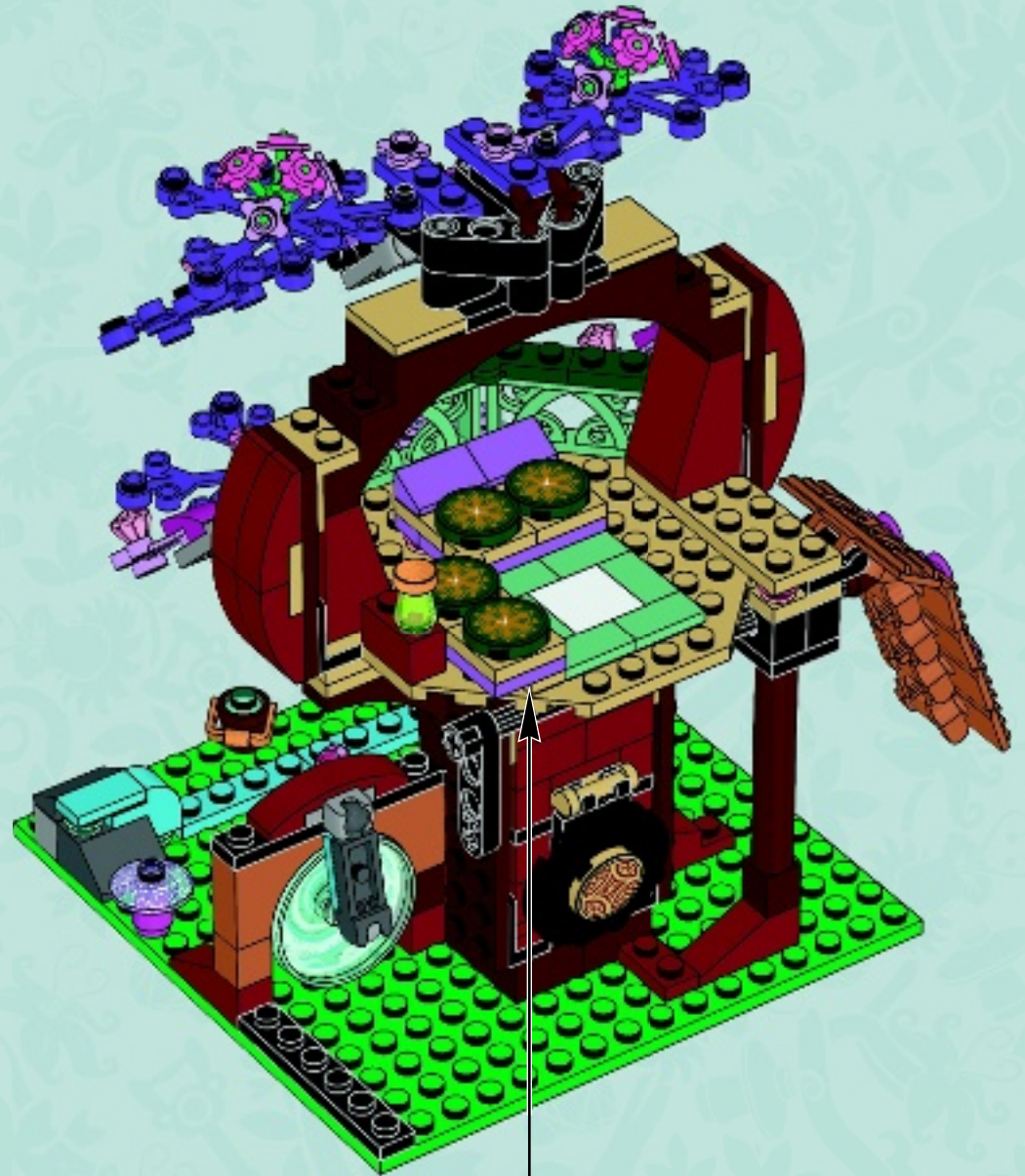
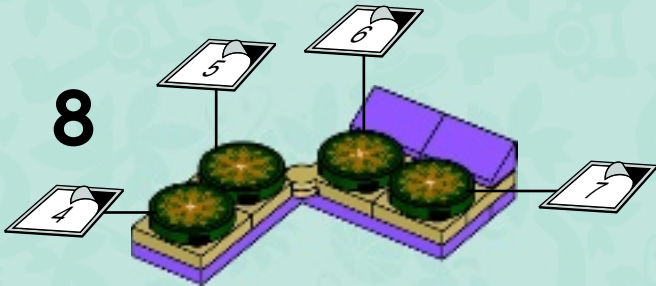

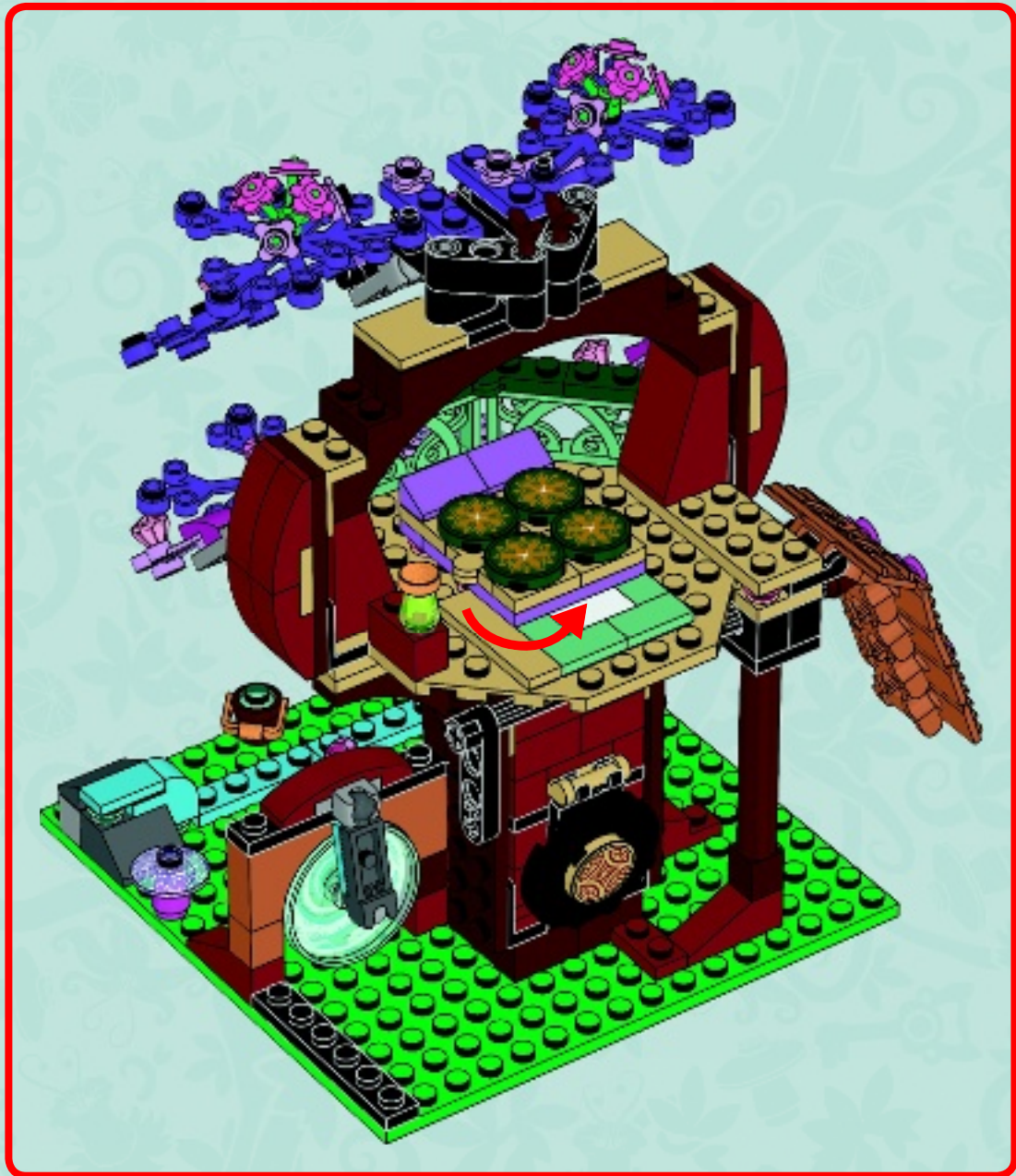

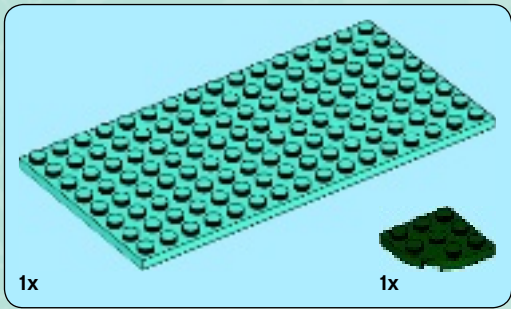

1

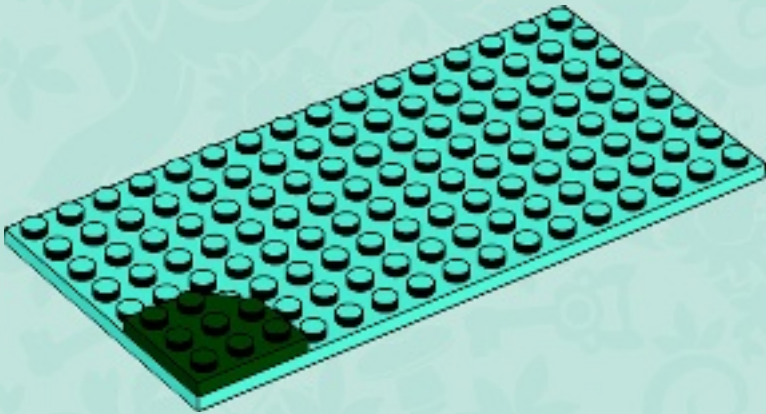

2

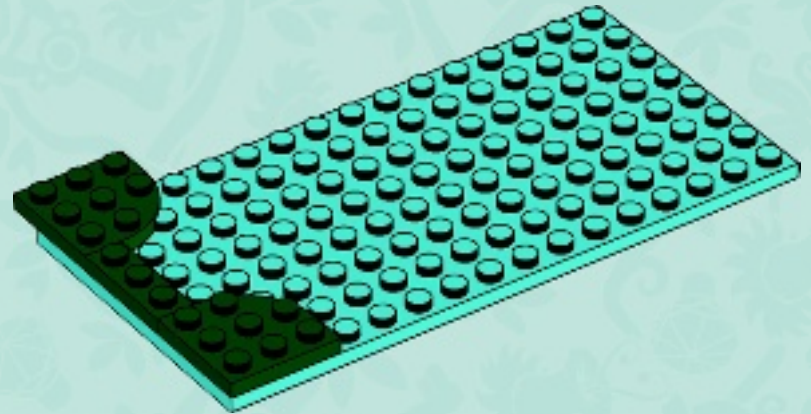

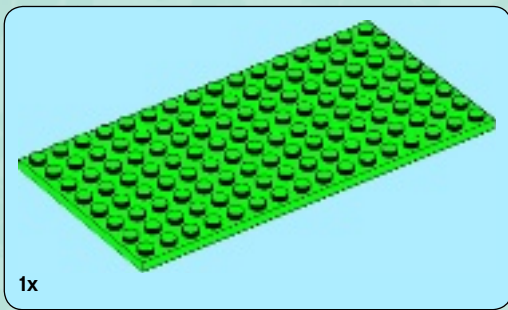

3

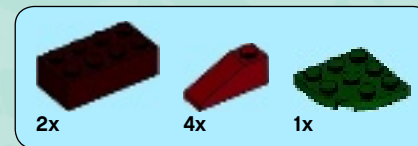
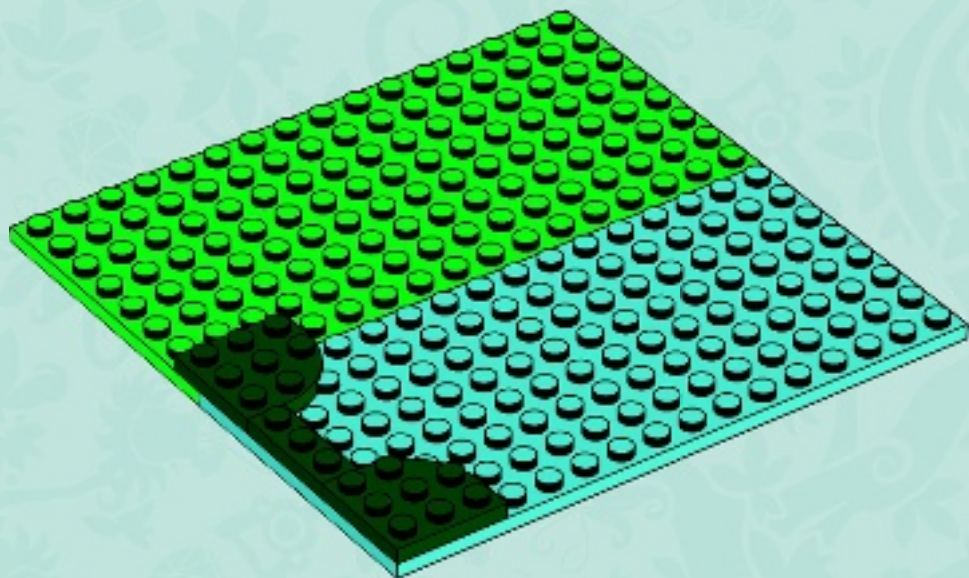

4

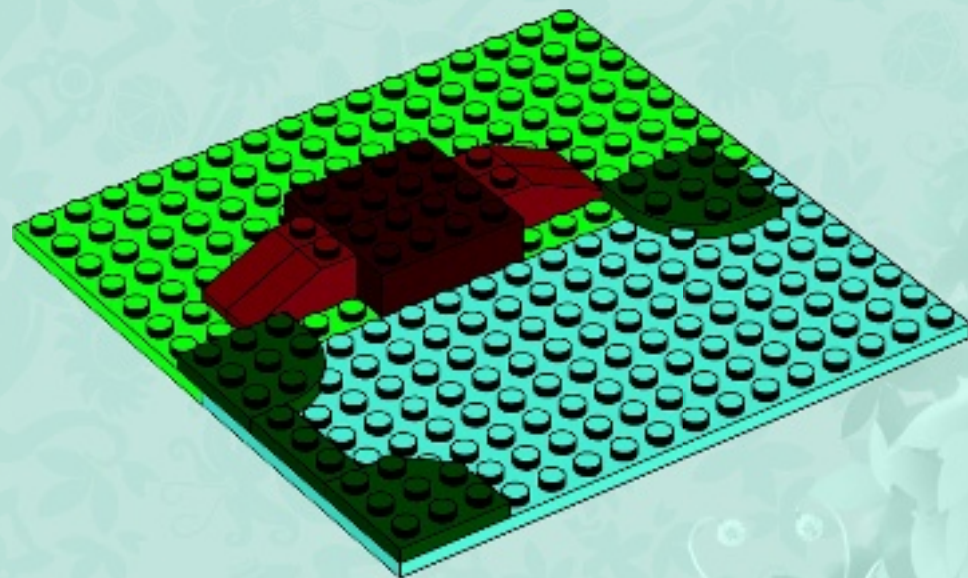

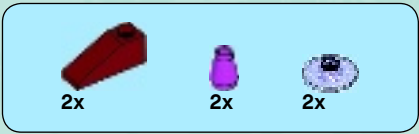

5

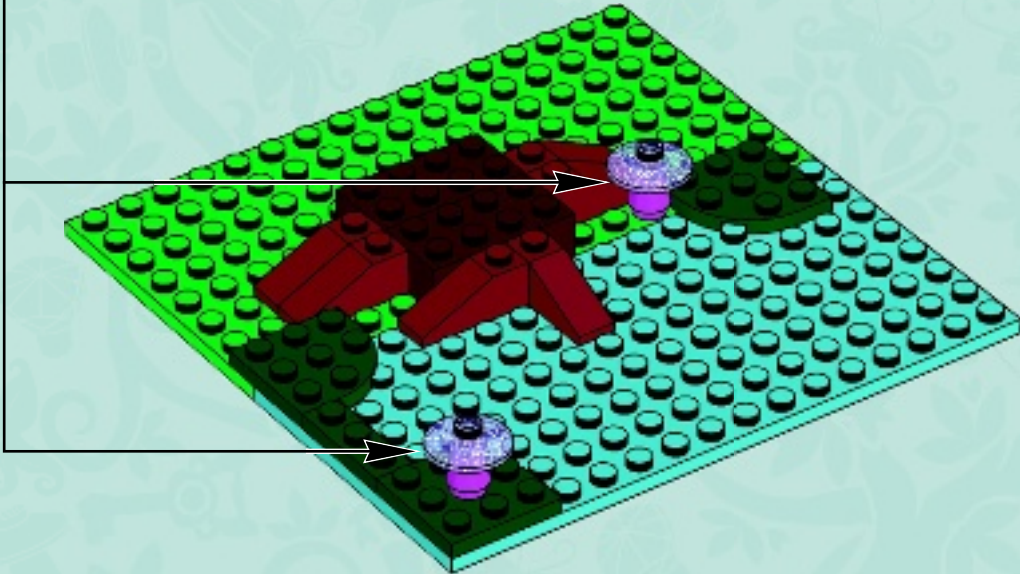

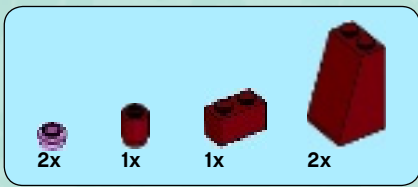

6

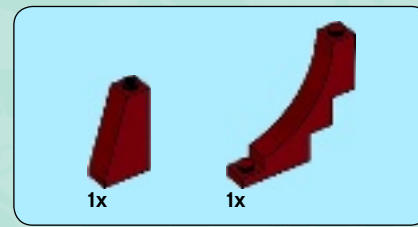
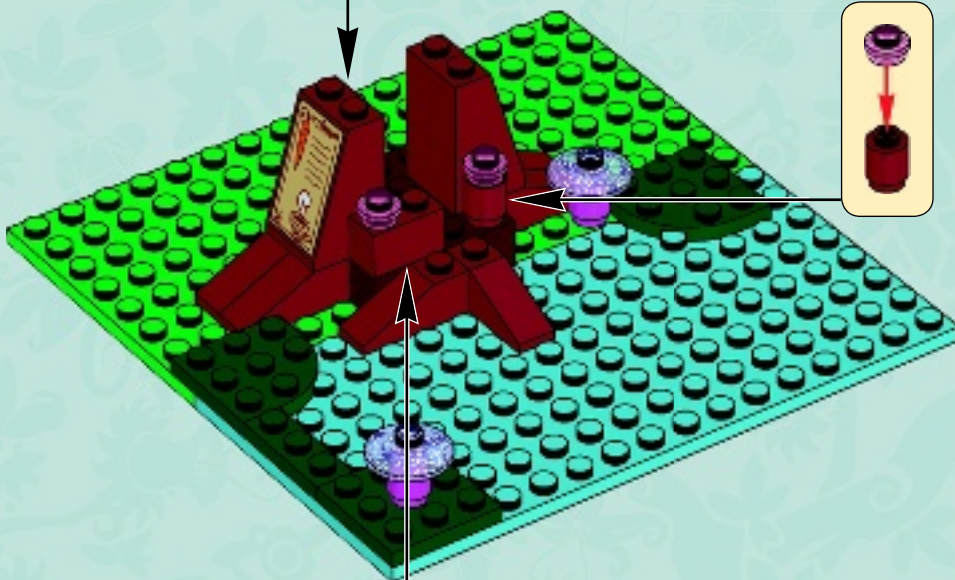

7





8

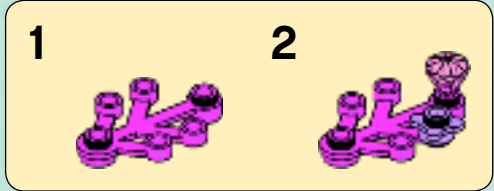
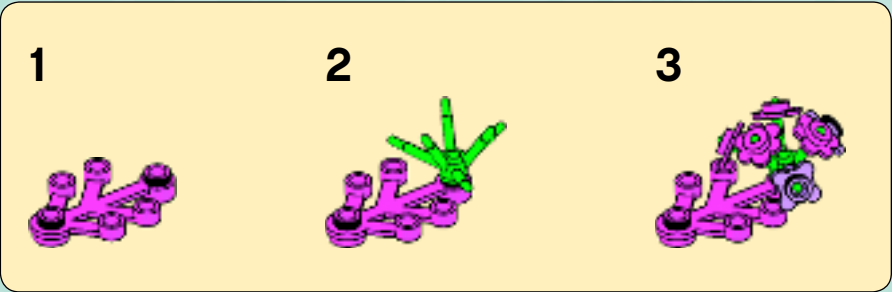



9

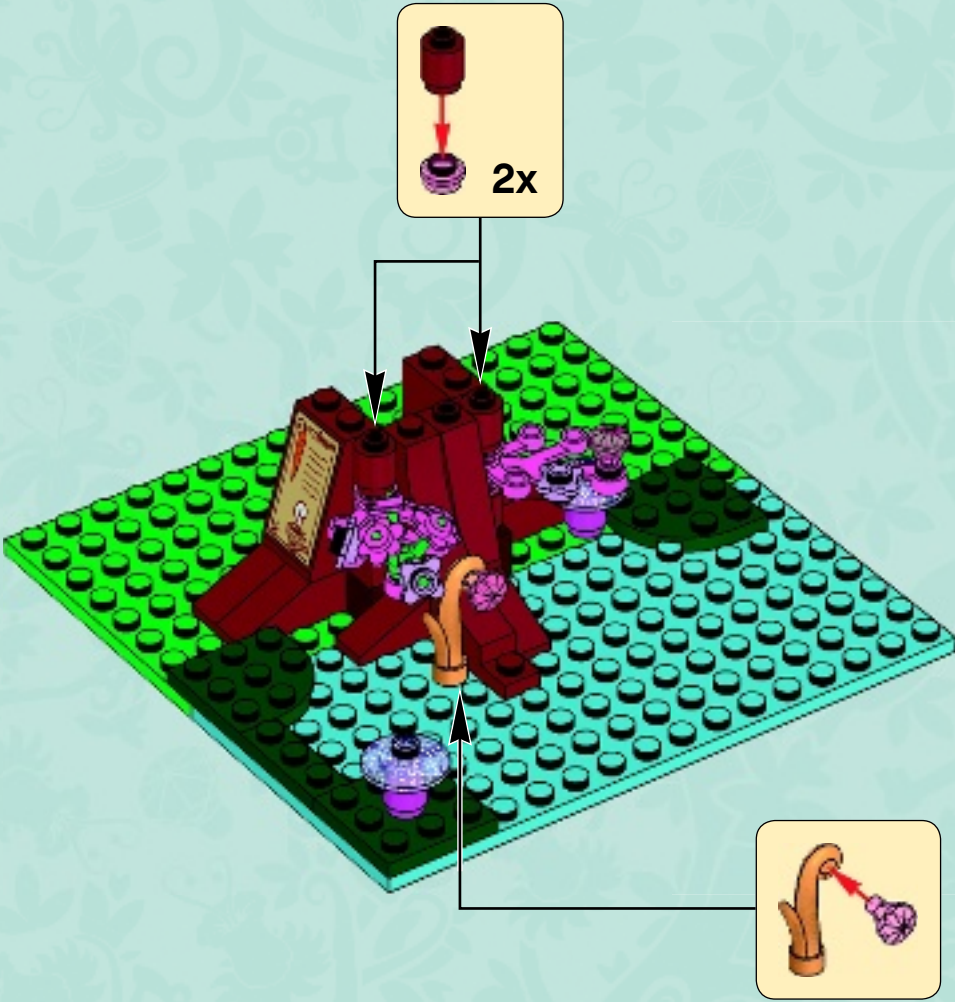

10

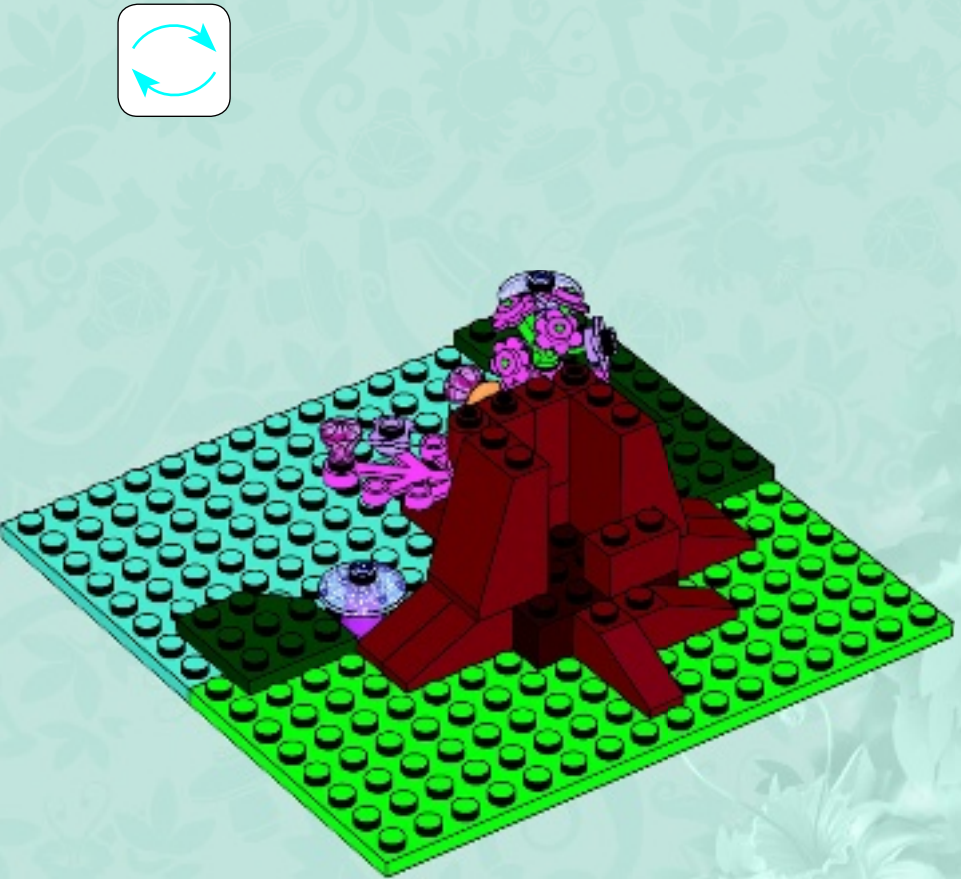

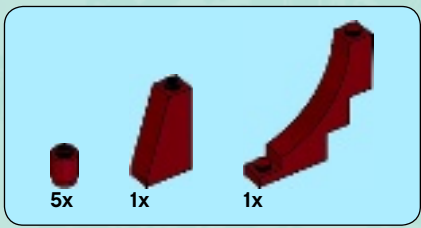

11

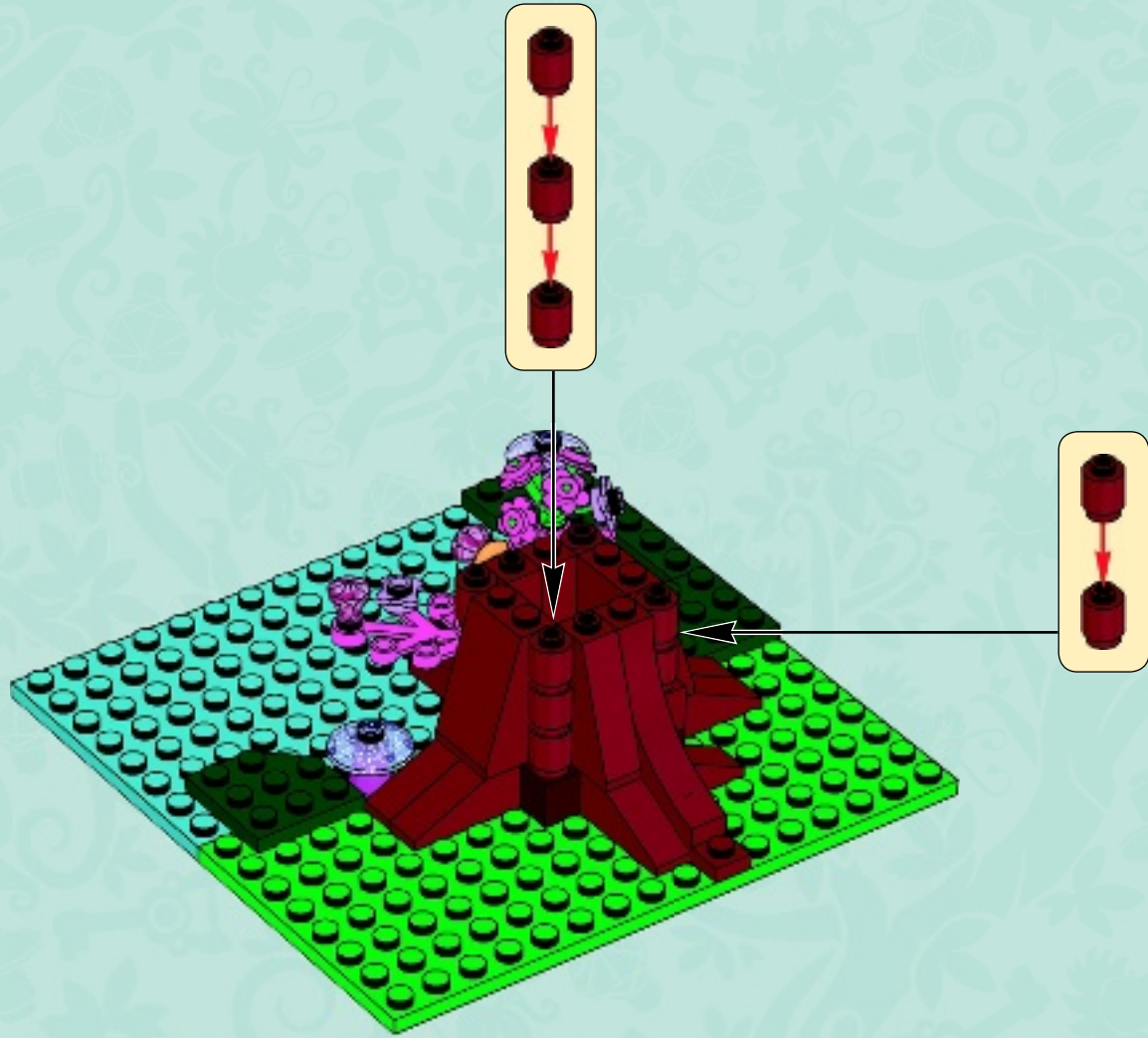

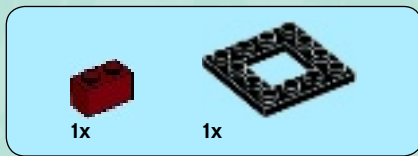

12

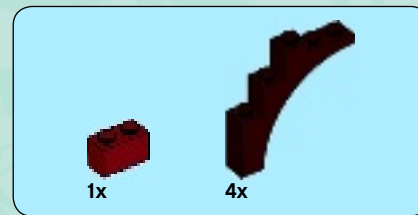

13

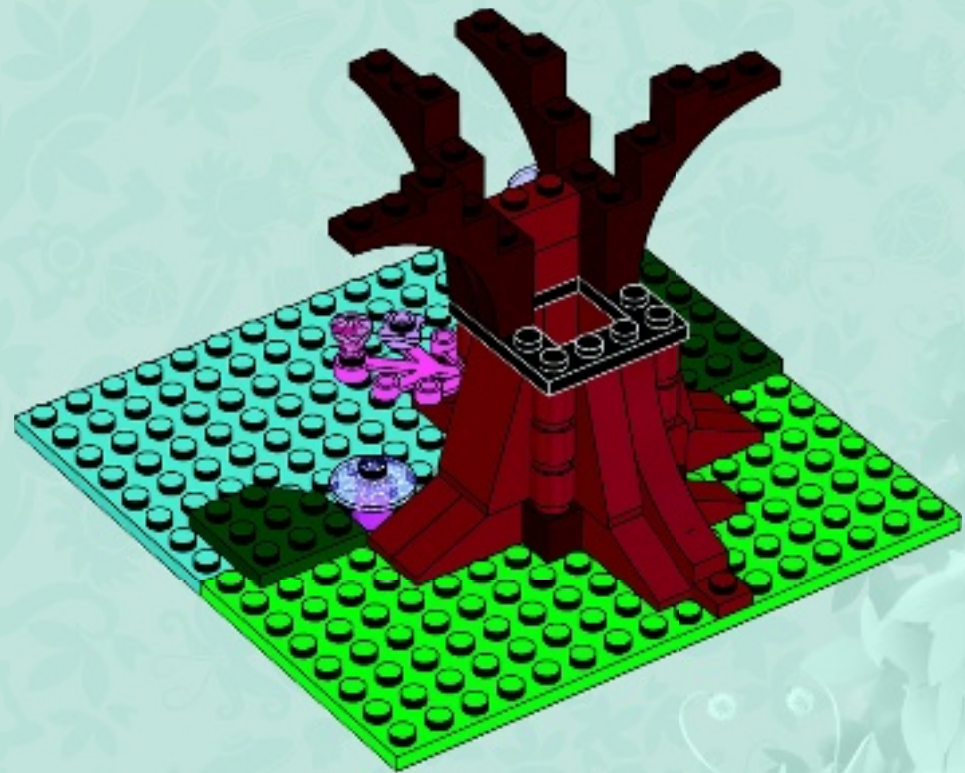



4x

14

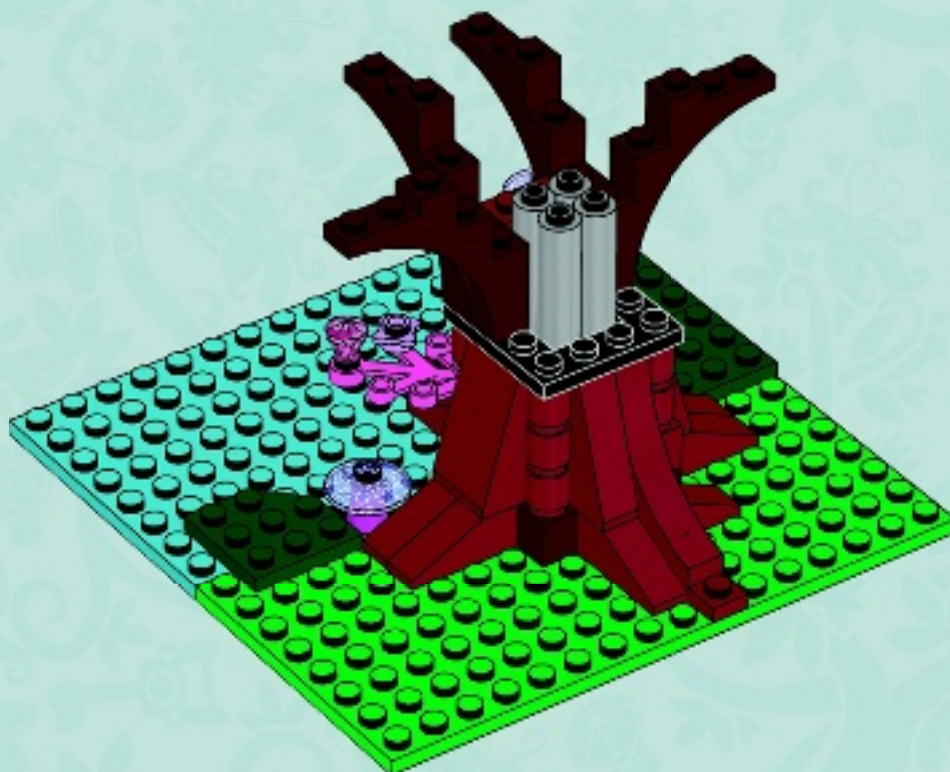



15

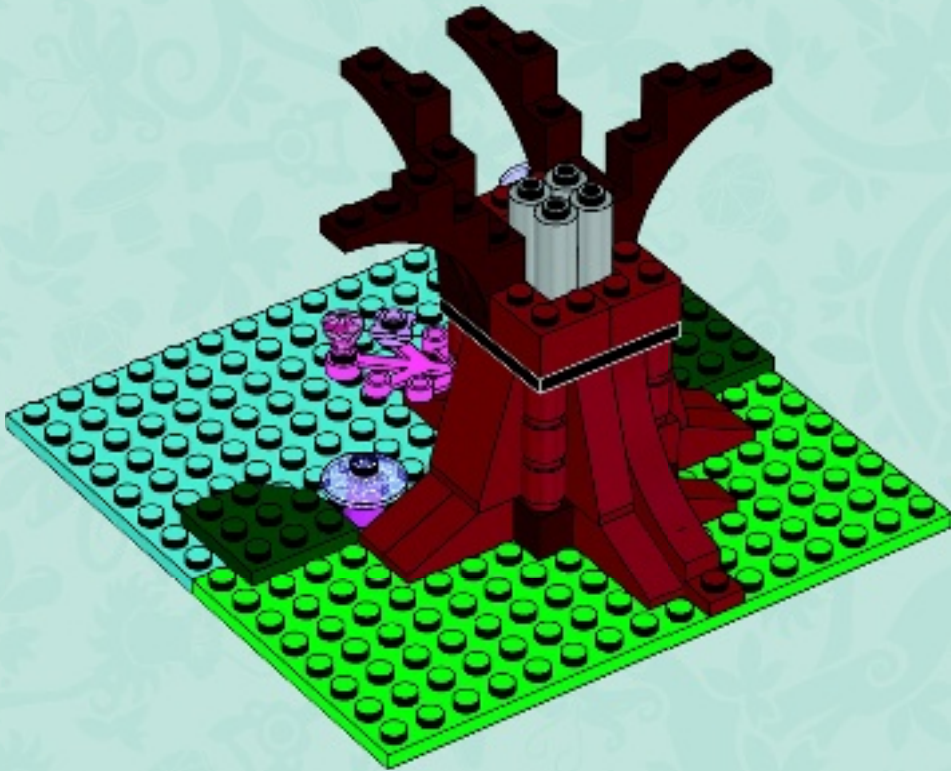

16

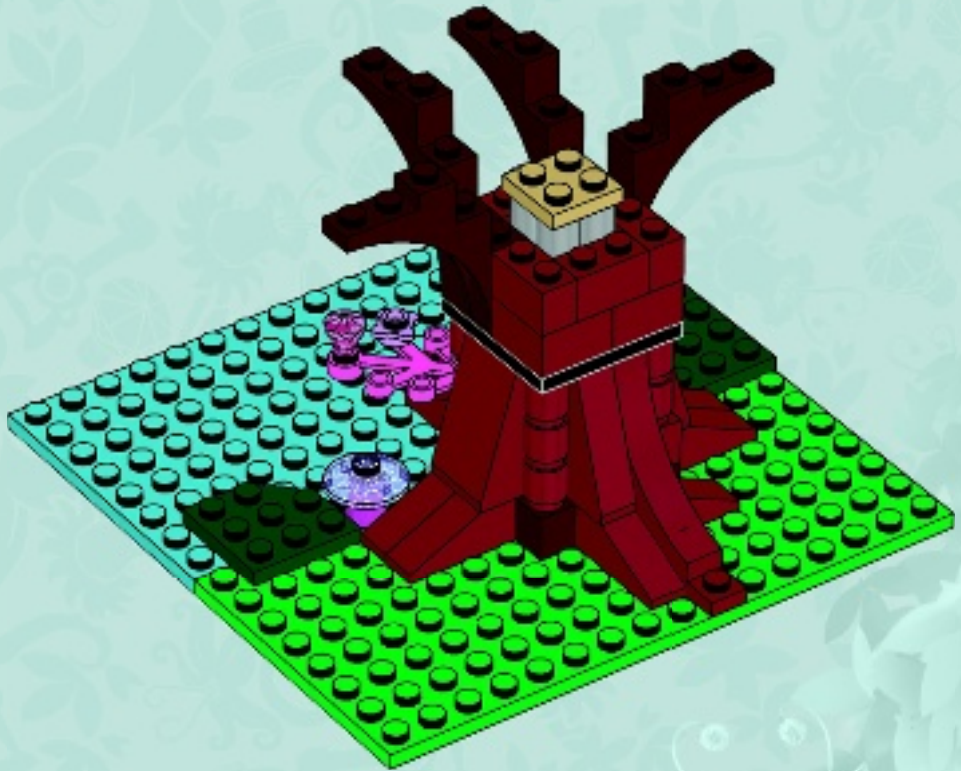



17

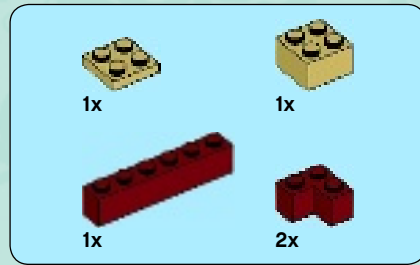
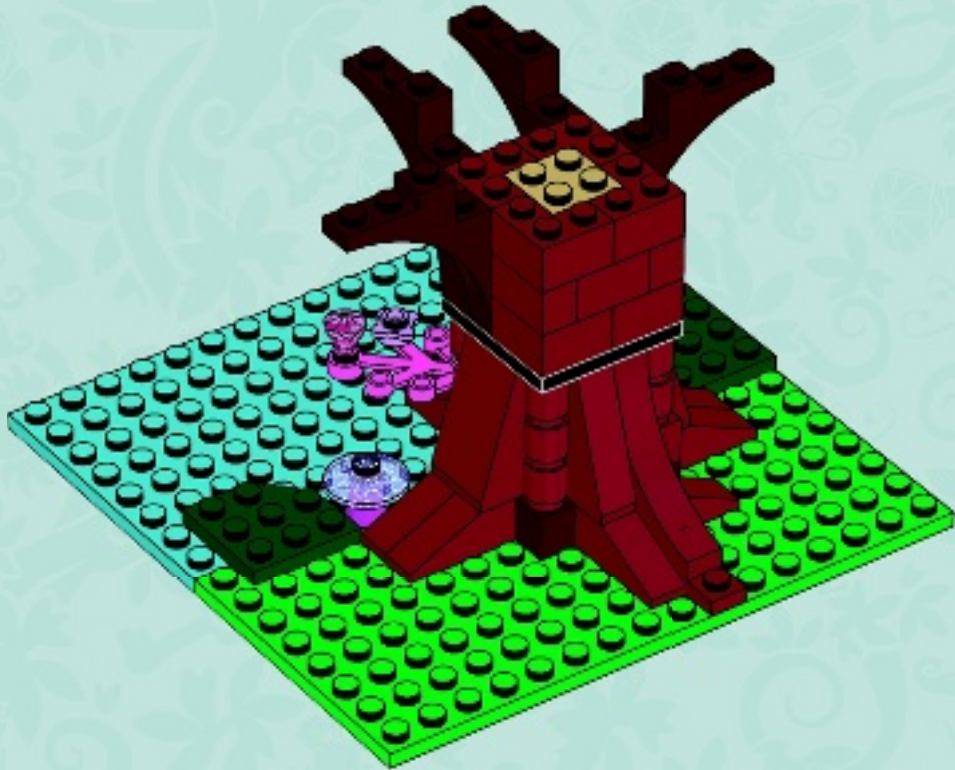

18

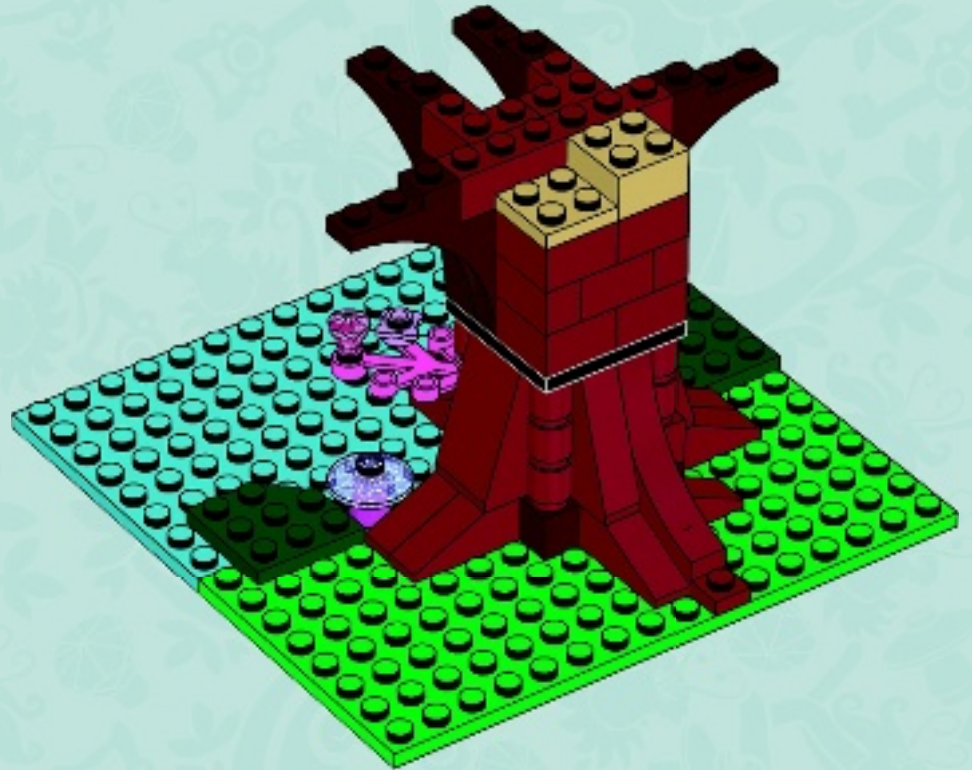

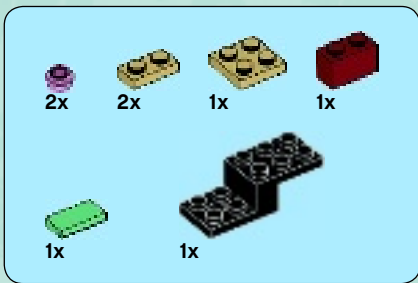

19

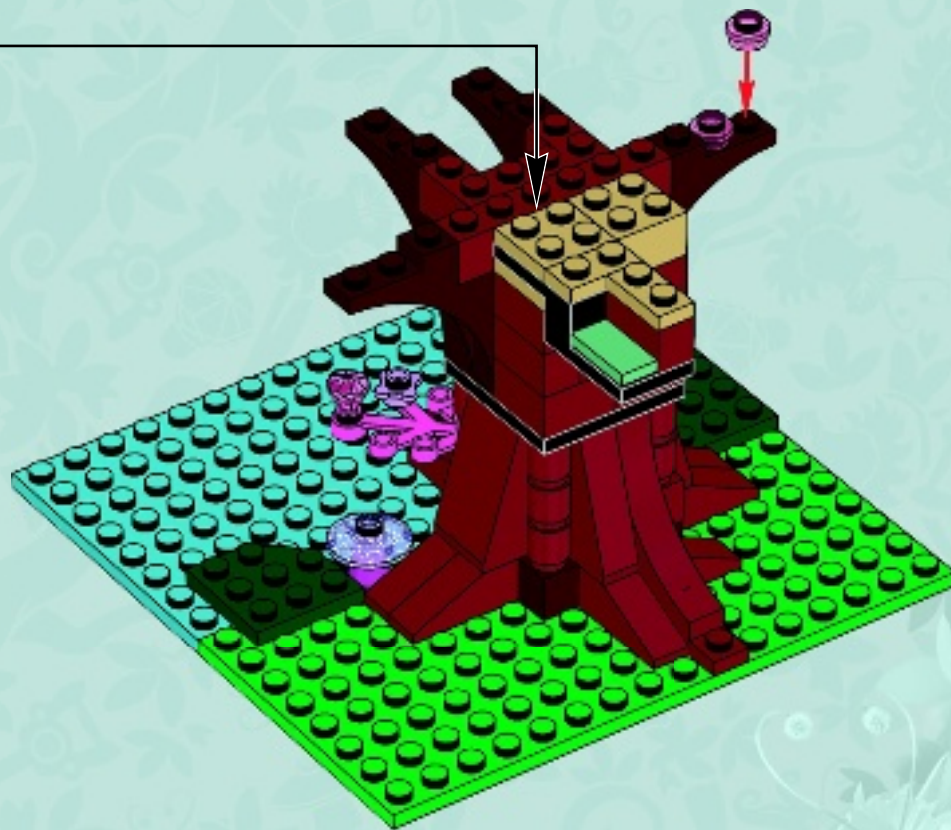
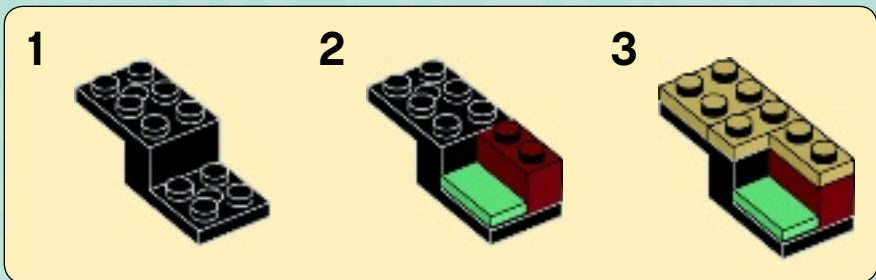



20

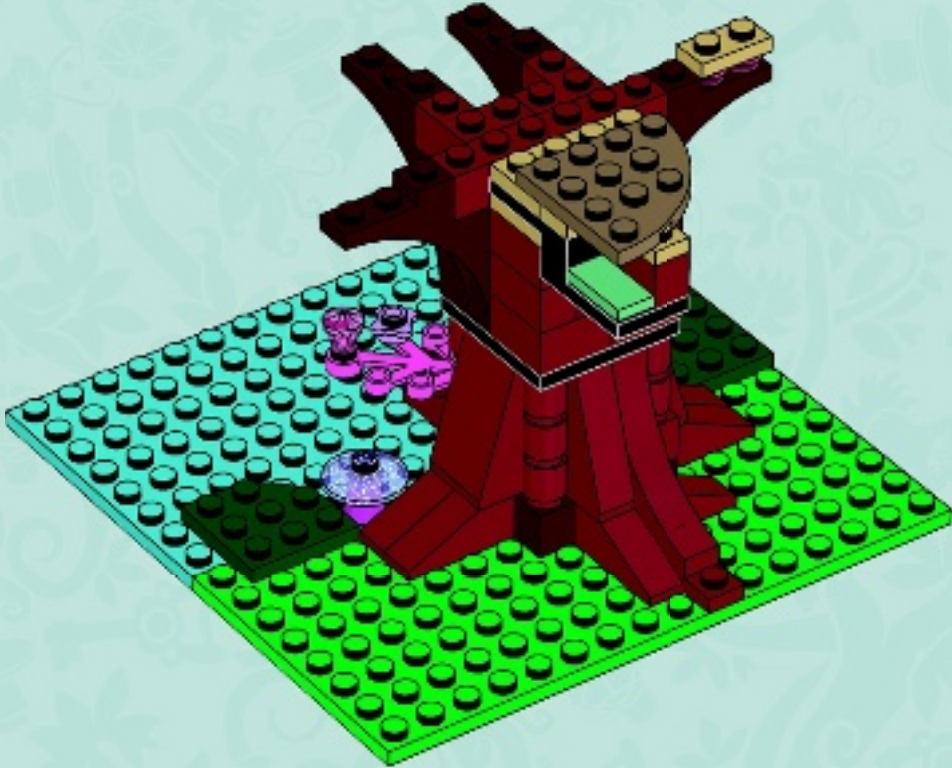

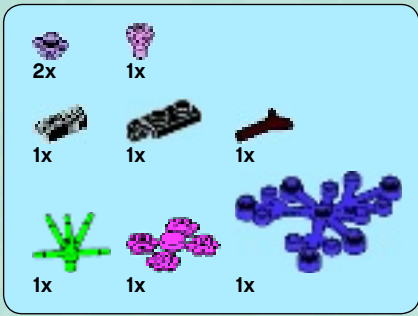

21

1



2



3



4



5

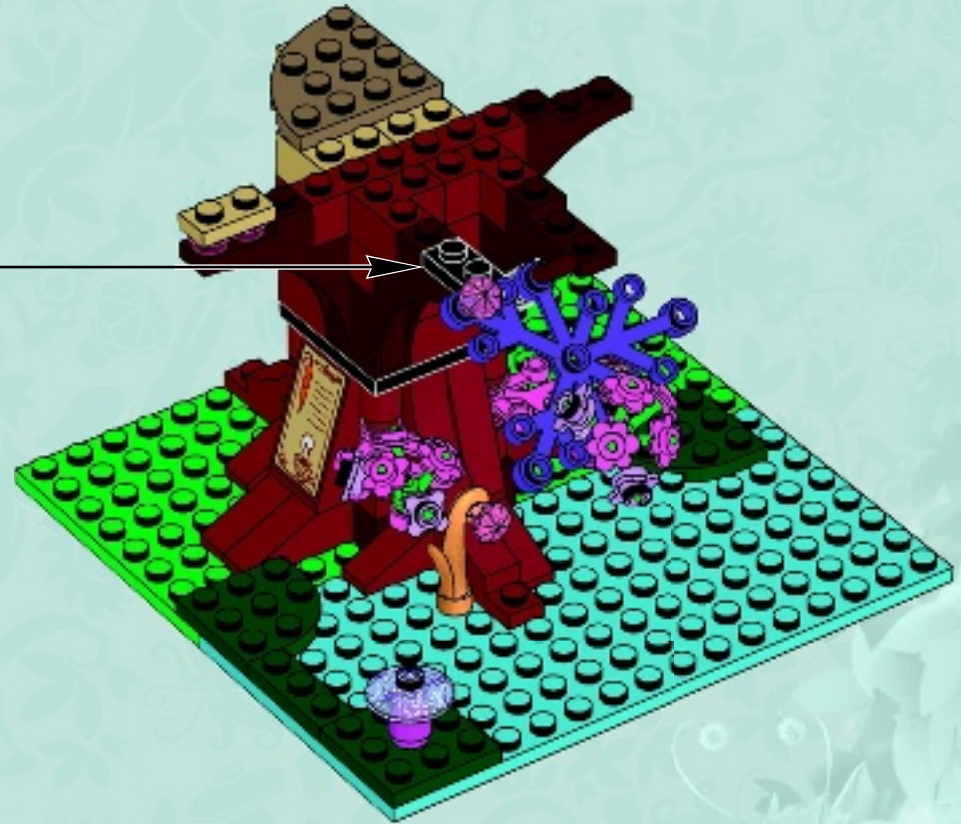
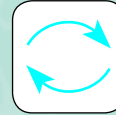

4



1x

1x



1

2x

2x

1x

2



2x

2x

3

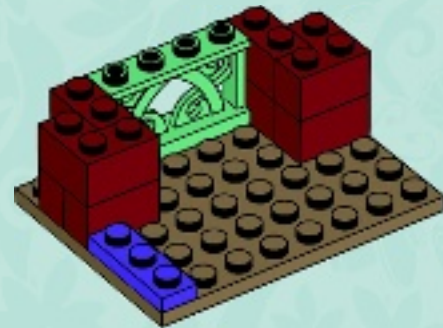

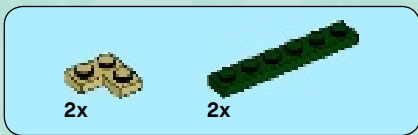

4

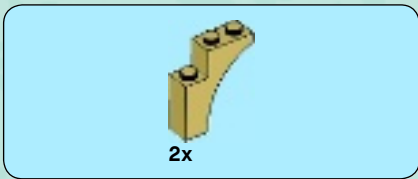

5

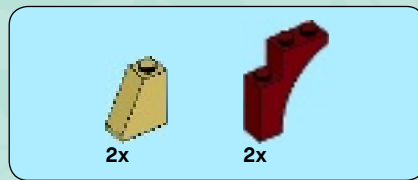

6

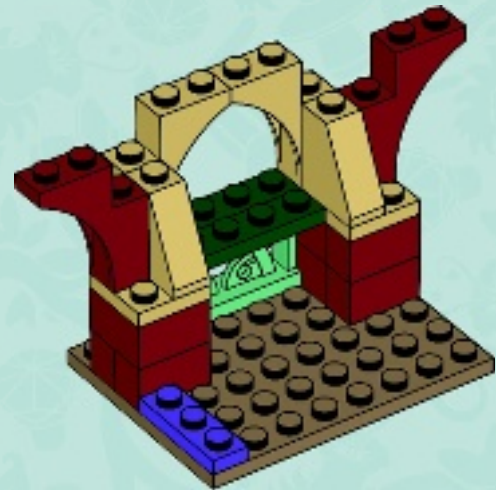



10



11



12

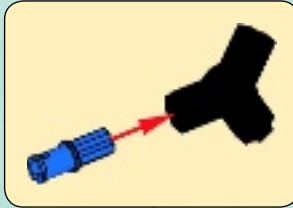

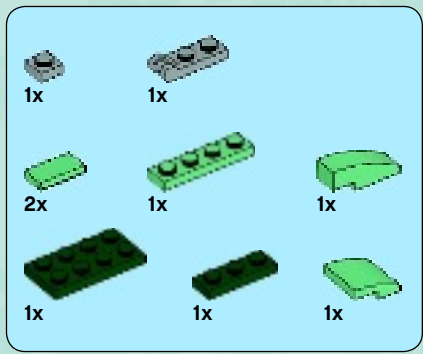

13

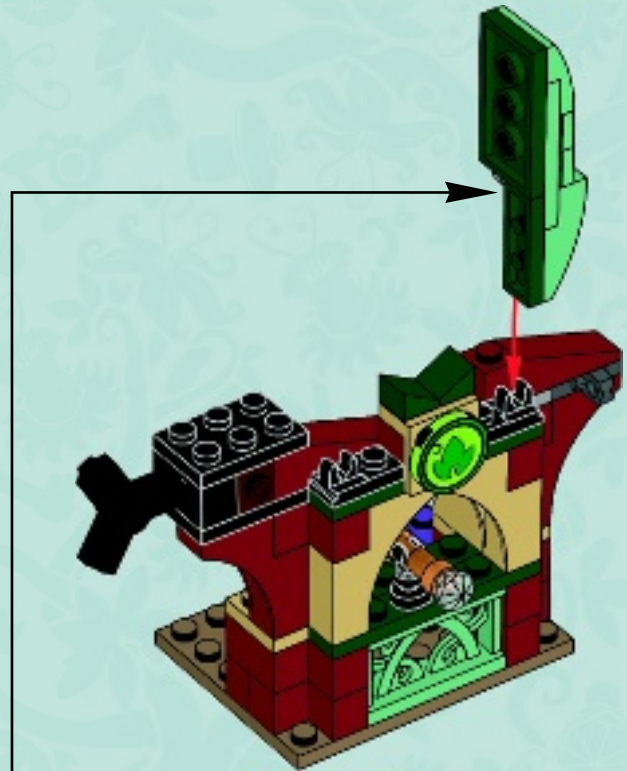
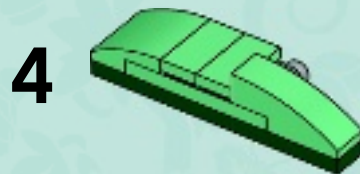
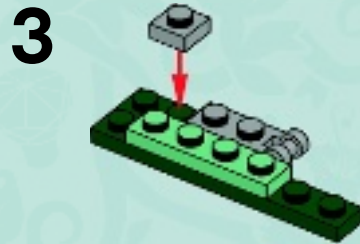
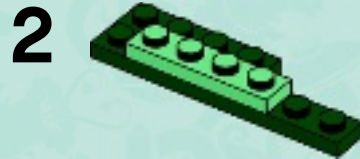
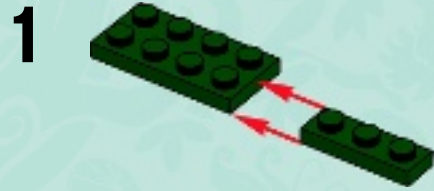

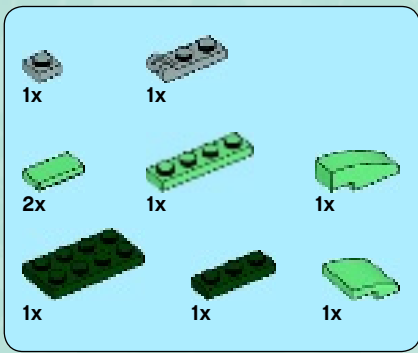

14

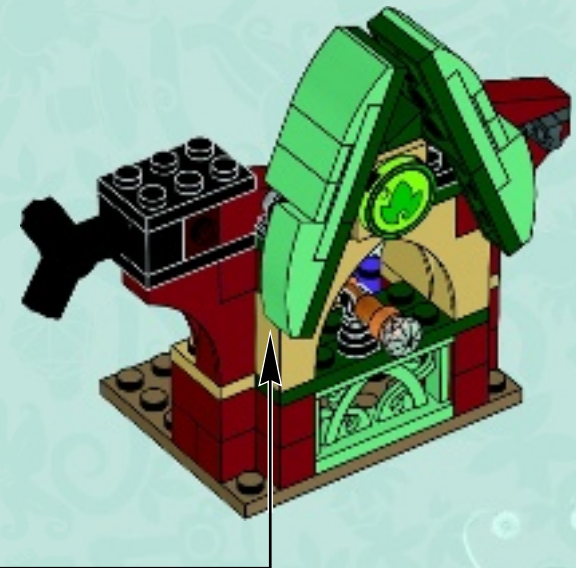
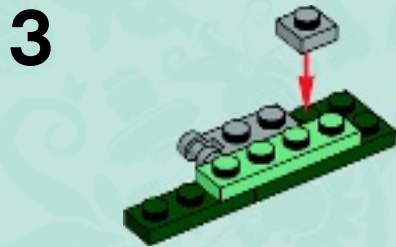
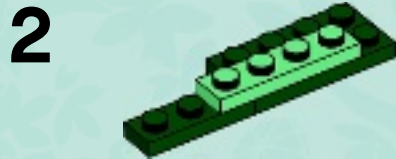
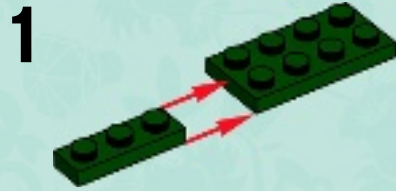

22

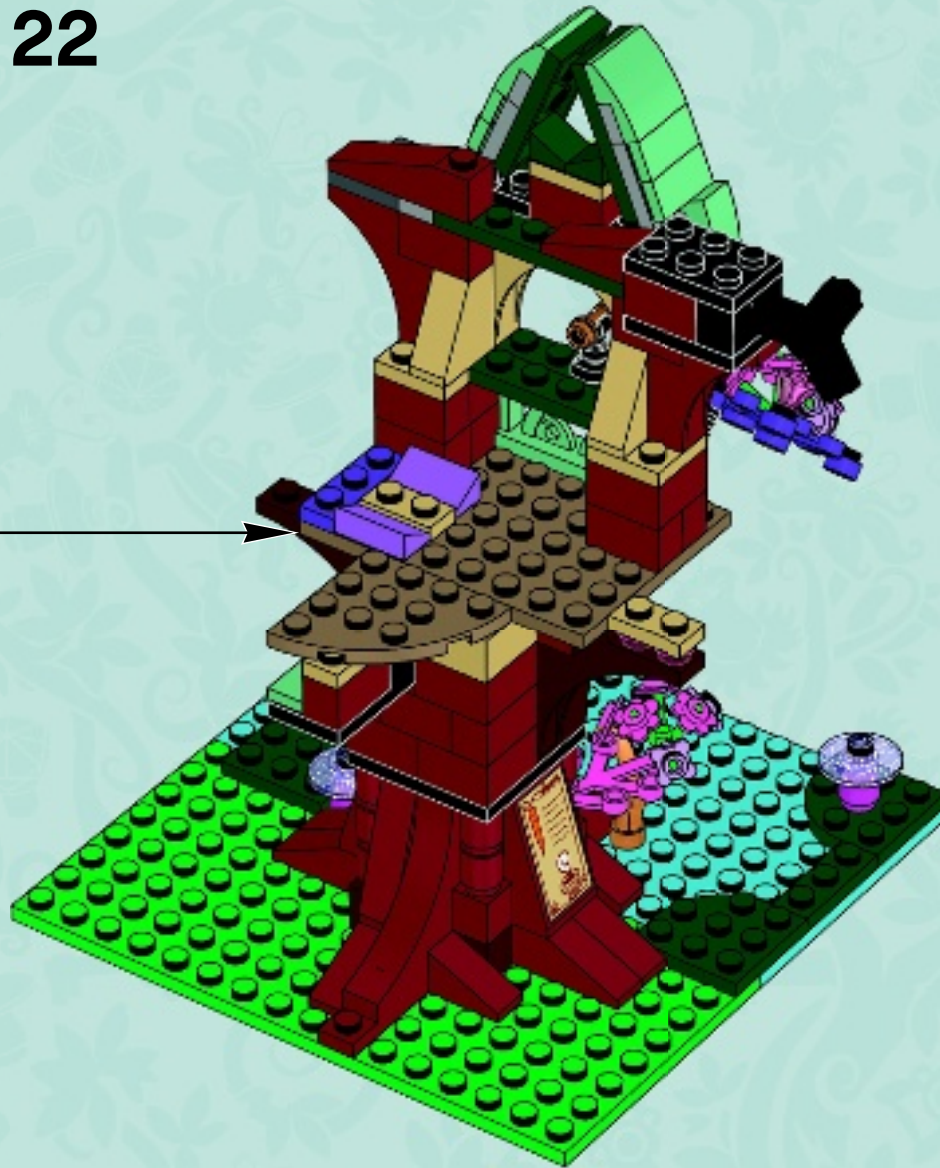
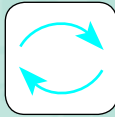



23

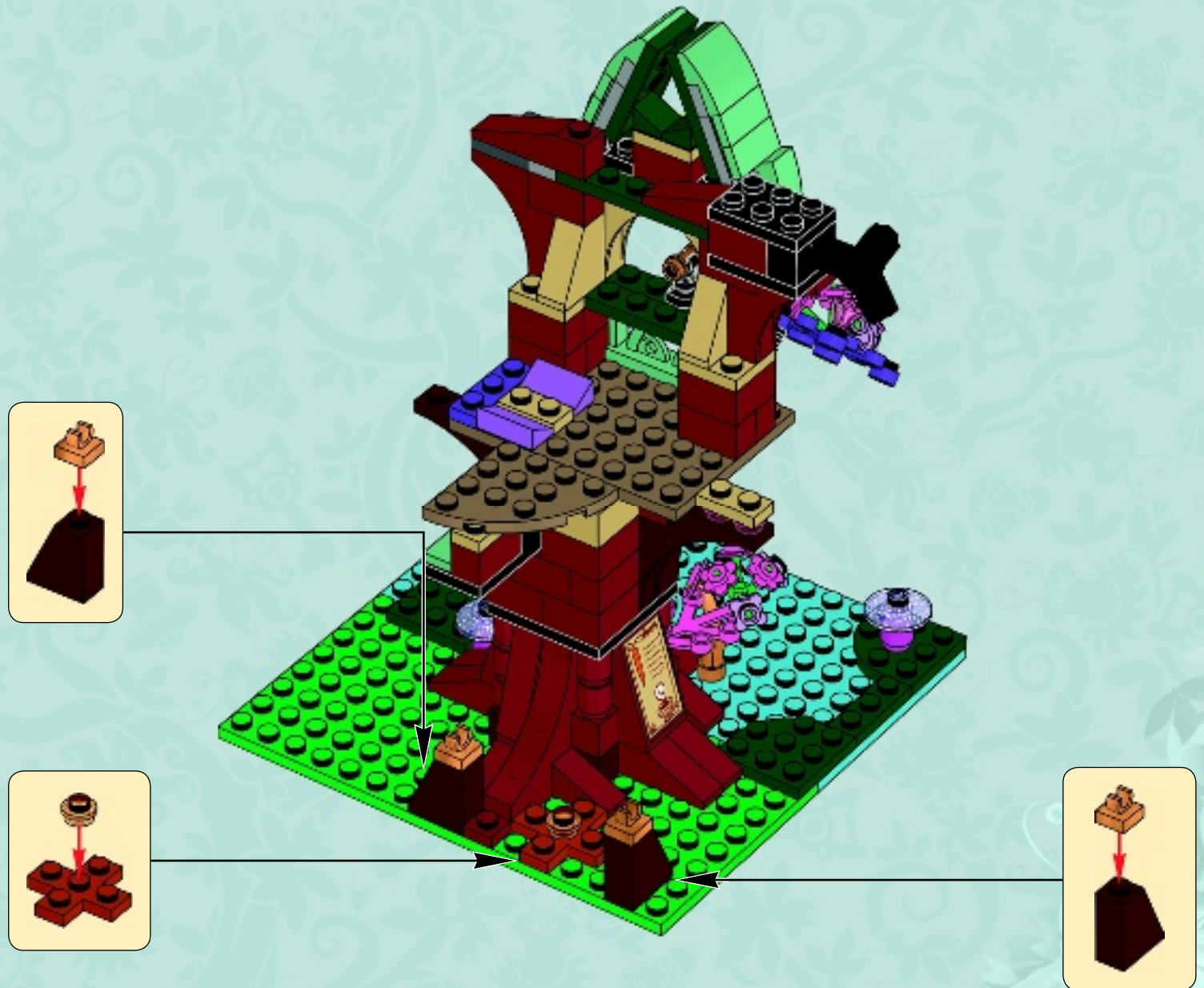

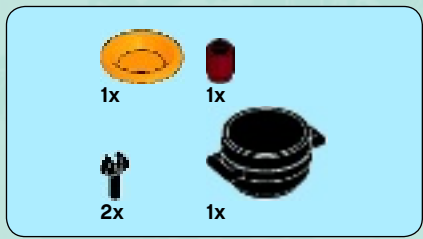

24

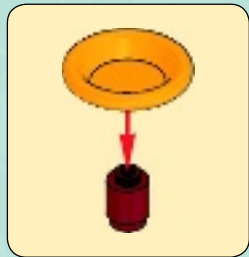
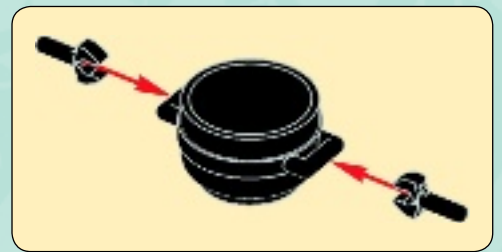

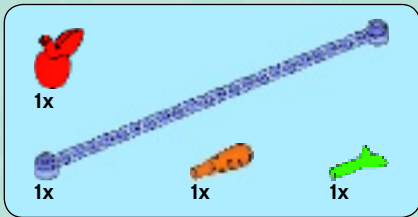

25

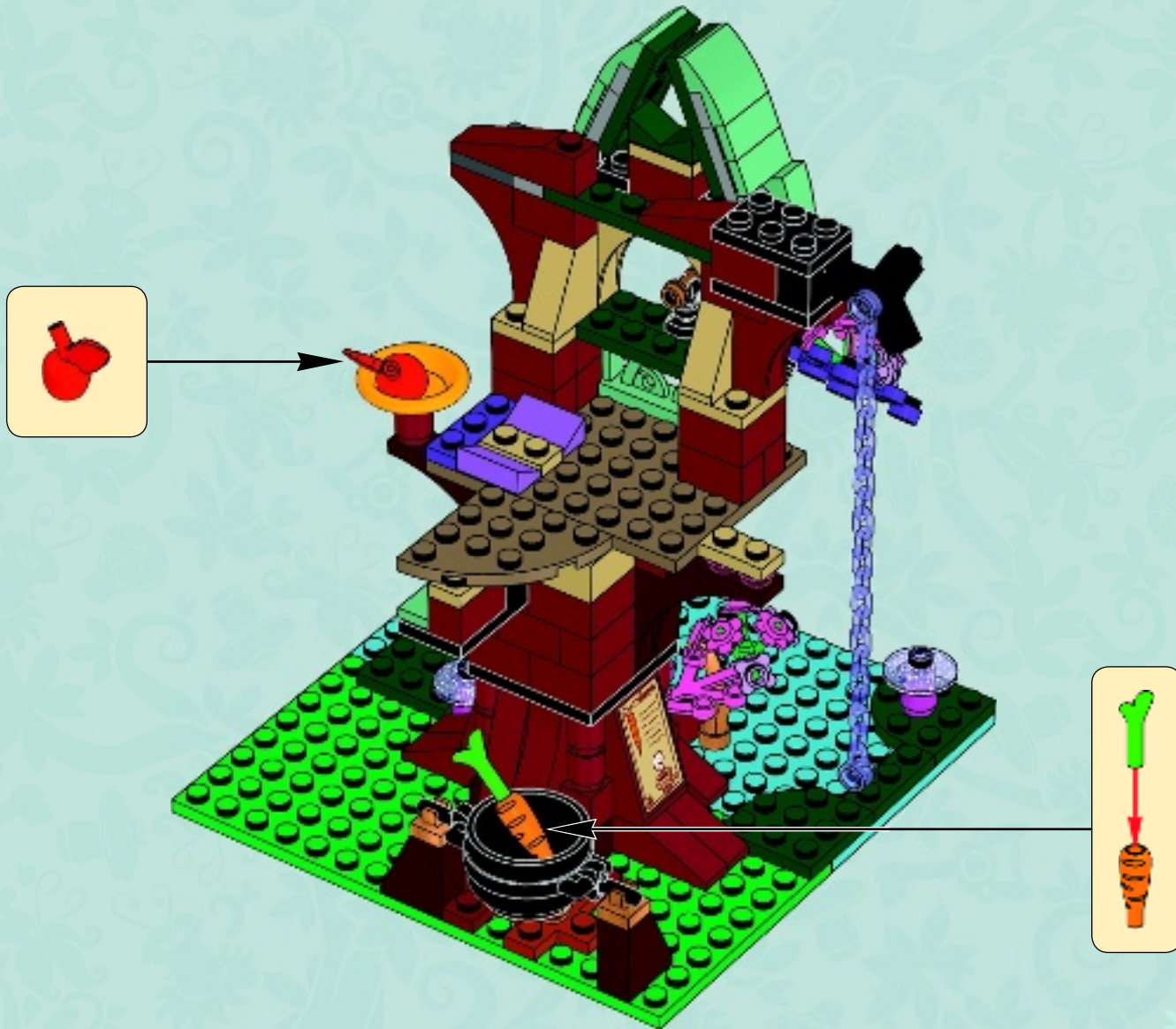

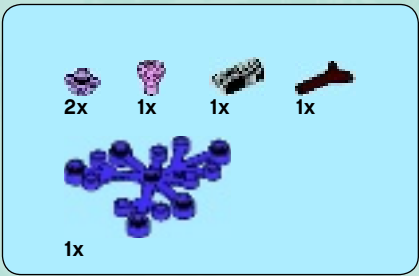

26

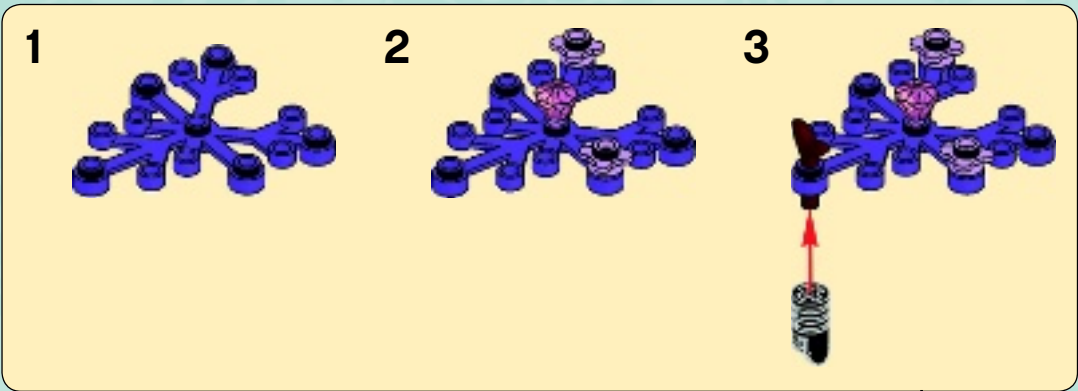

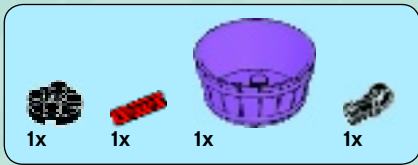

27

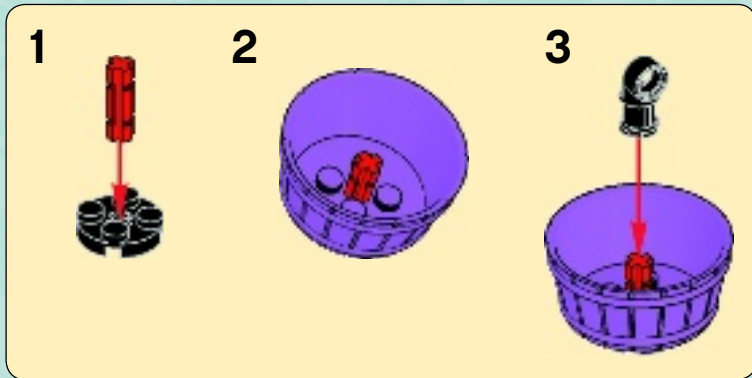

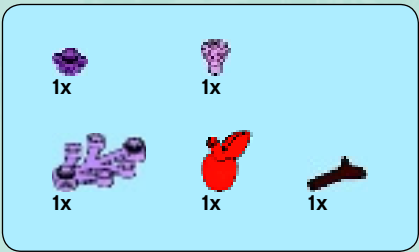

28

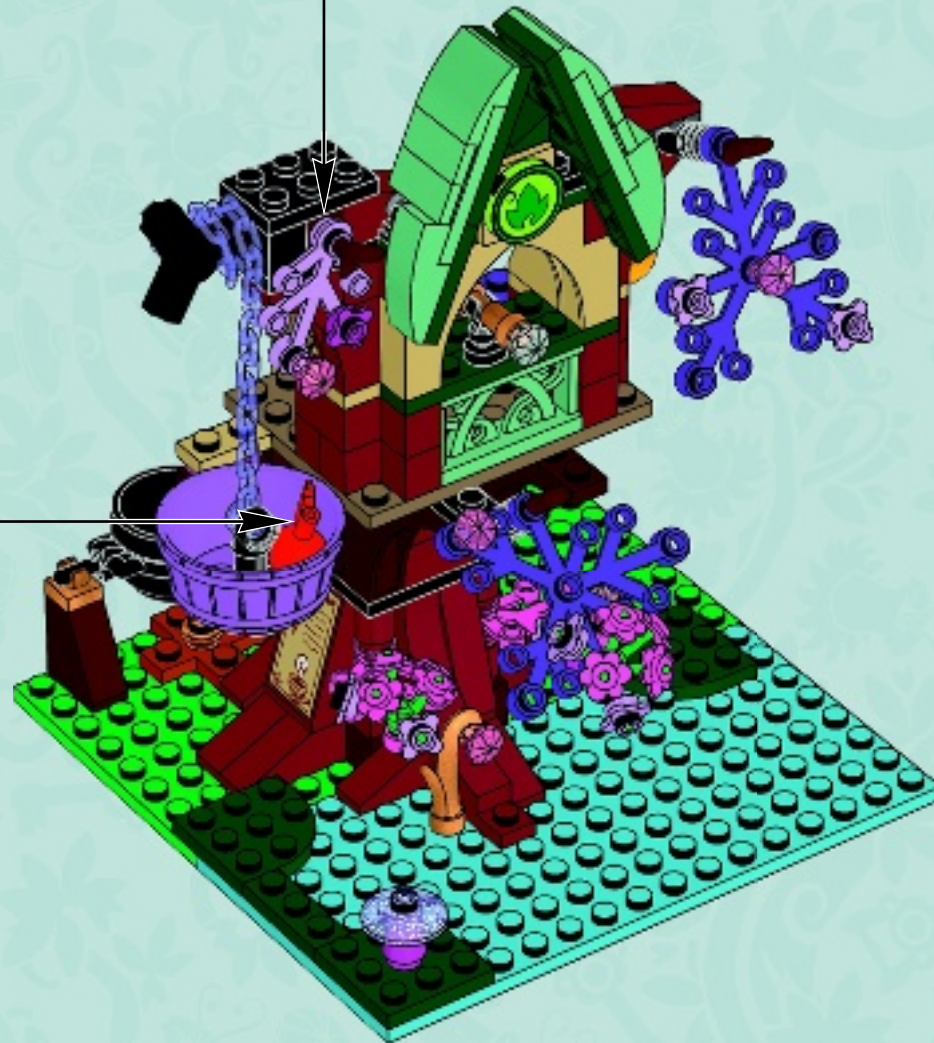
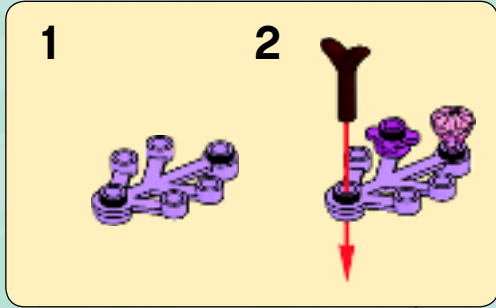

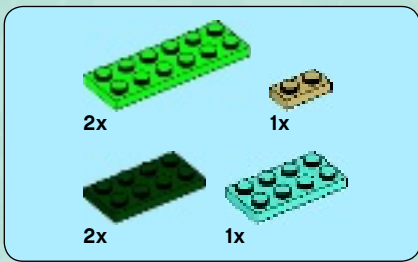

29





53

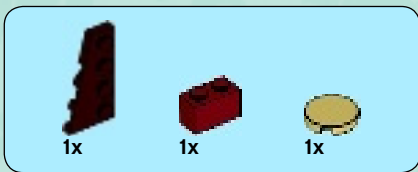

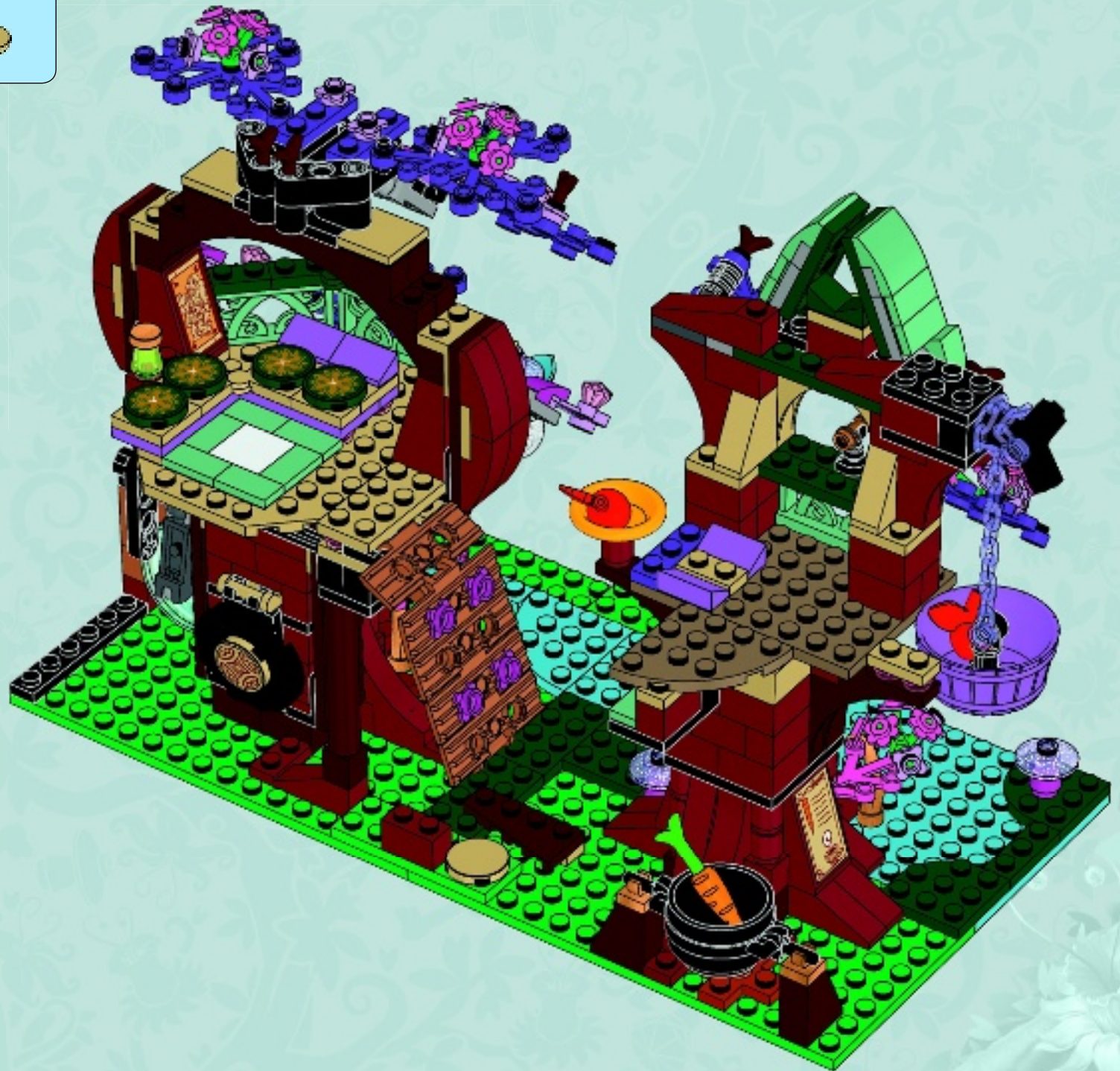
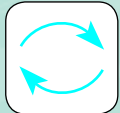

54



2x  1x 

55

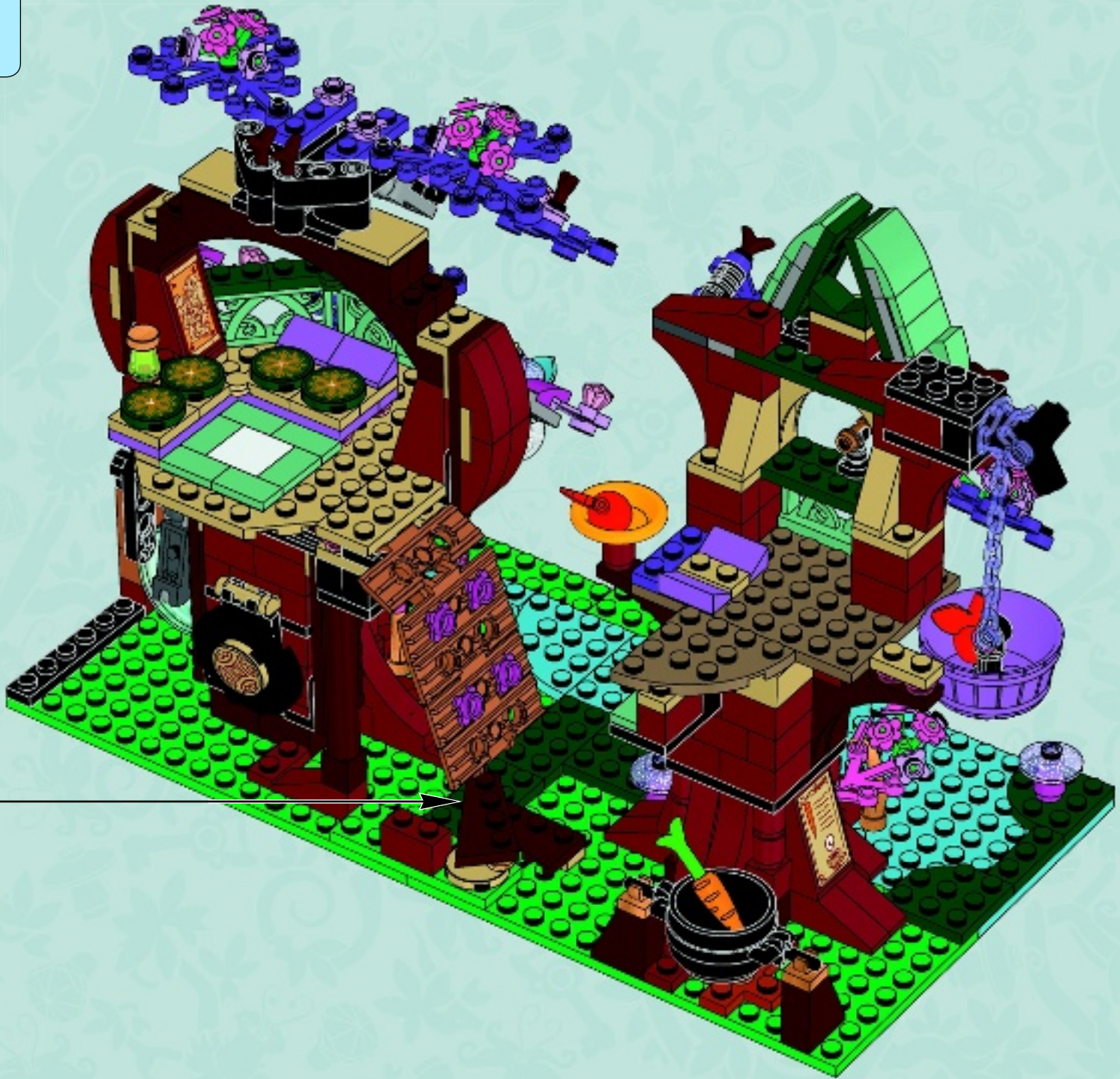



56

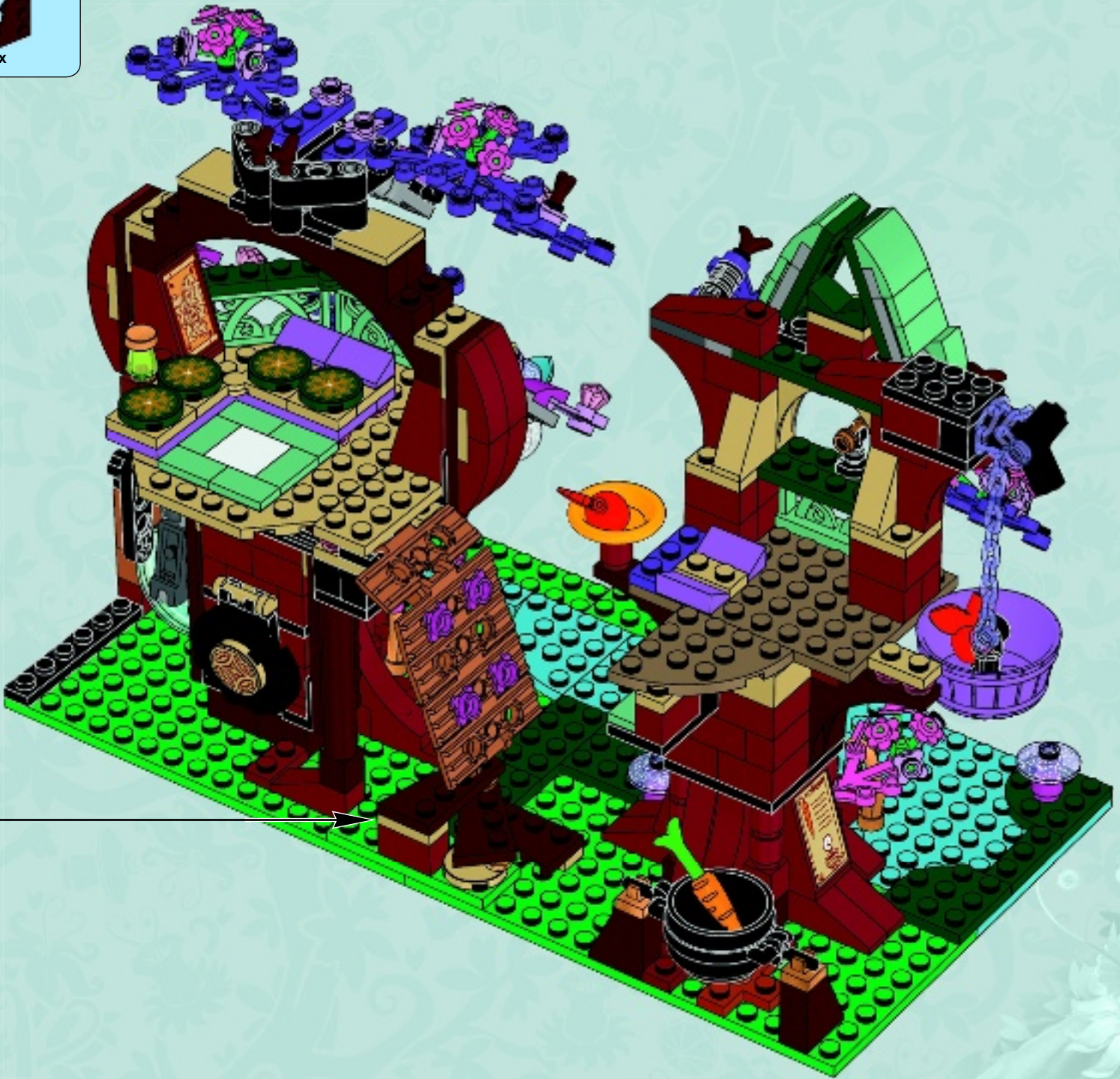

1x  3x 

57

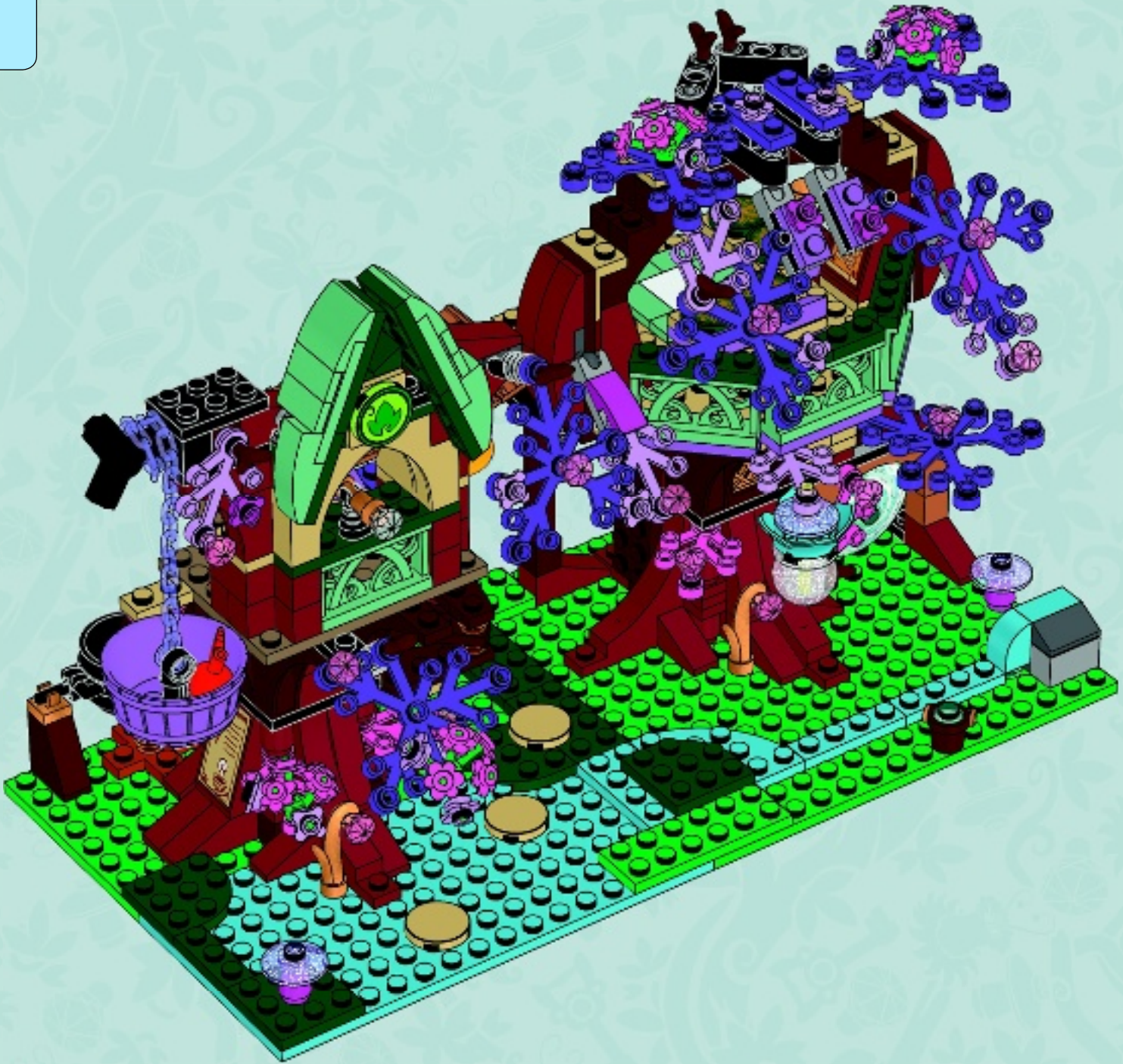





3x
614301



1x
306801



1x
4119410



1x
4114306



1x
4624086



2x
4626200



1x
4114322



2x
6058093



12x
4113917



7x
4114084



2x
4185177



4x
4114077



3x
4550324



3x
4114309



1x
371026



2x
302126

42



1x
4113993



1x
4114324



5x
6117975



1x
4217562



5x
6066344

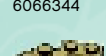

1x
6102772



2x
6054438



1x
4142865



4x
4143005



1x
4206482



2x
6039194



3x
370026



2x
302126



1x
371026



1x
302026



1x
366626



1x
6058118



1x
447726



2x
4598528



4x
4569733



4x
6000650



1x
4225201



2x
4535739



1x
4183043



2x
4258354



1x
403226



1x
6038453



1x
4525078

2x
4289538

2x
4143372



2x
4142822



2x
4120017



1x
4143466



1x
4107136



1x
4660886



1x
370826



2x
379528



4x
6097232



1x
4119479



1x
6062215



1x
4248937



1x
4646864



5x
4163917



1x
6110077



1x
4646860



1x
4124054



1x
6103249



1x
4654448



1x
6093747



14x
4599535



13x
4129917



1x
6104413



7x
6078932

3x
6003007

2x
6070763



1x
6107429



1x
6097525



4x
6093752



1x
6109383



1x
6106043



1x
6102301



1x
4251796



1x
4570451



2x
4504375



2x
6013102



3x
6013975

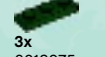

4x
4586057



4x
4245566



4x
6092771



4x
6001836



1x
6103241



2x
6102779



2x
6080431



2x
6100237



11x
4616578



2x
6100234



4x
6097680



24x
4539102



16x
4541379



6x
6052777



1x
4541528



11x
4539099

2x
4590811



Customer Service
Kundenservice
Service Consommateurs
Servicio Al Consumidor
LEGO.com/service or dial

: 00800 5346 5555
: 1-800-422-5346



ELVES

the land of
Elvendale
completing the quest

Desertlands



Red Mountain

The great mountain of Silad

Windy Beach

Blue Water Bay

Sparkle Rock

Leaflands

The Izdus Ocean

Leaf High Hill

Island

 LEGO.com/elves