

1518

Sisyphus

1324 pieces

A custom model design by
Jason Allemann

jkbrickworks.com

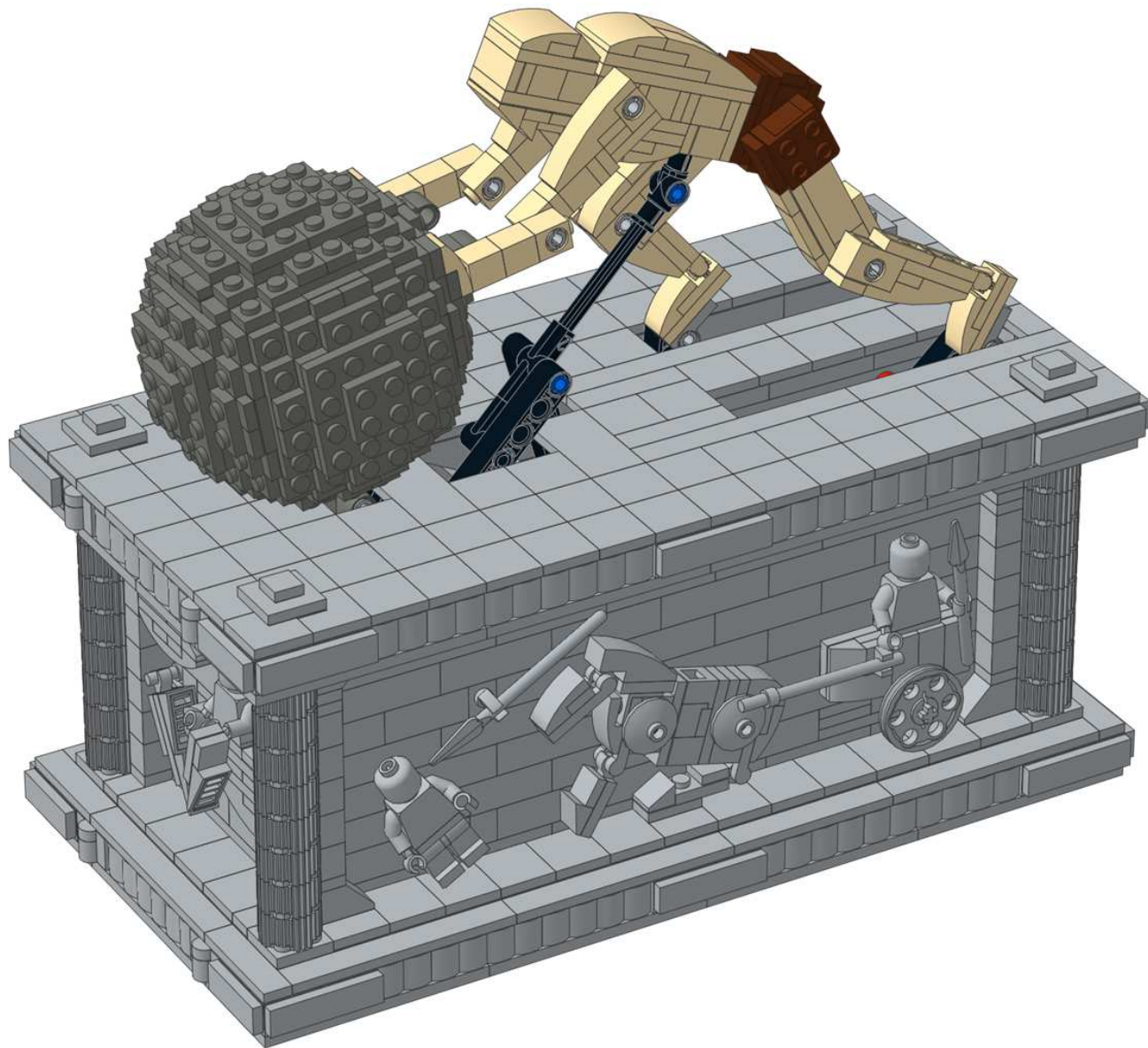

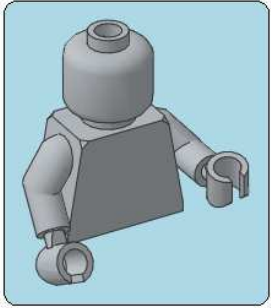

x2

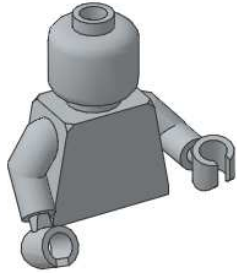
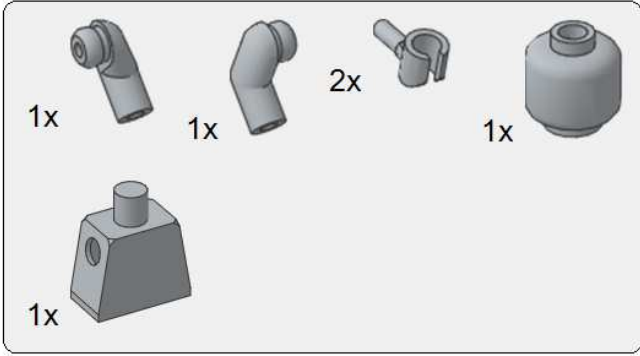

x2

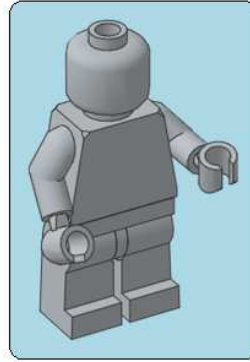

x5

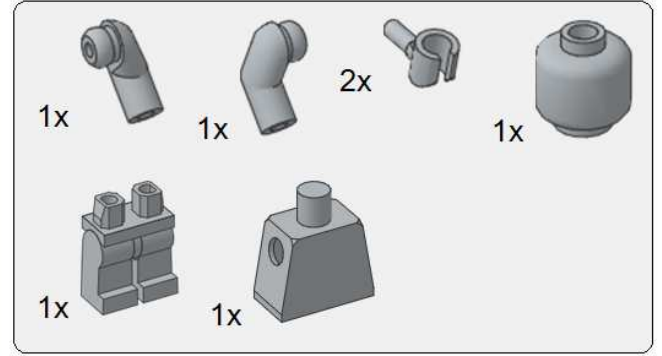

x5

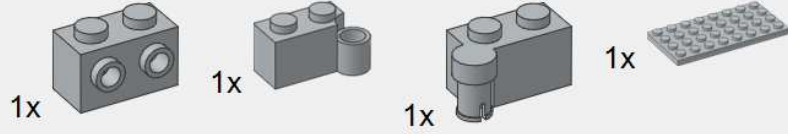
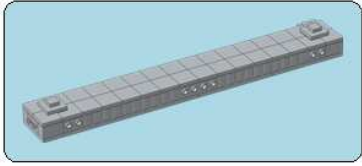

1

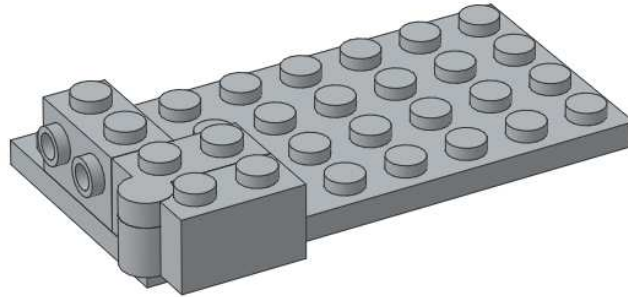

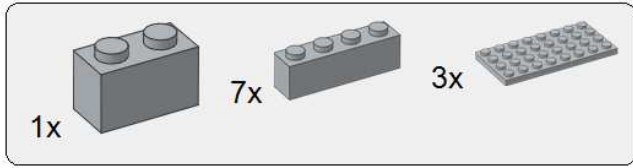

2

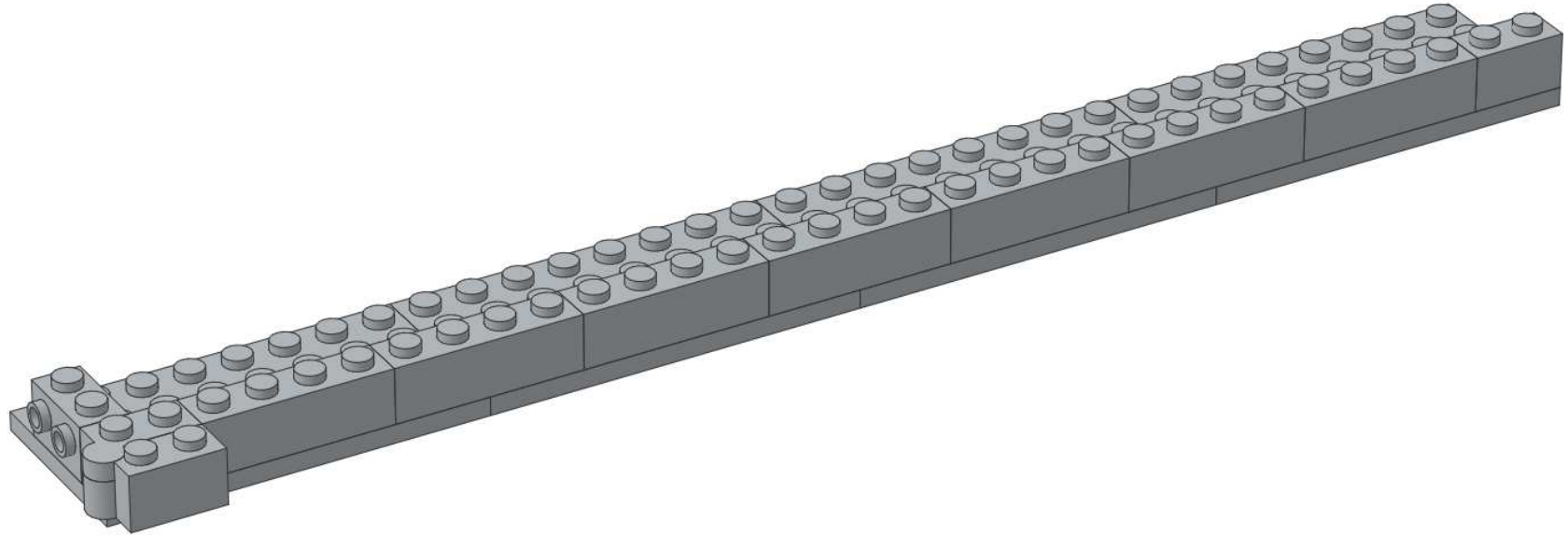

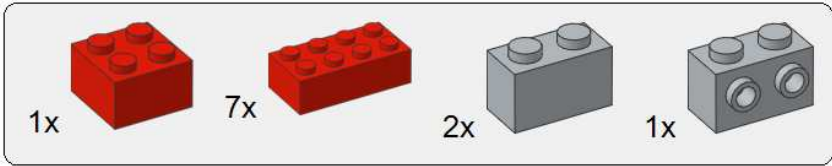

3

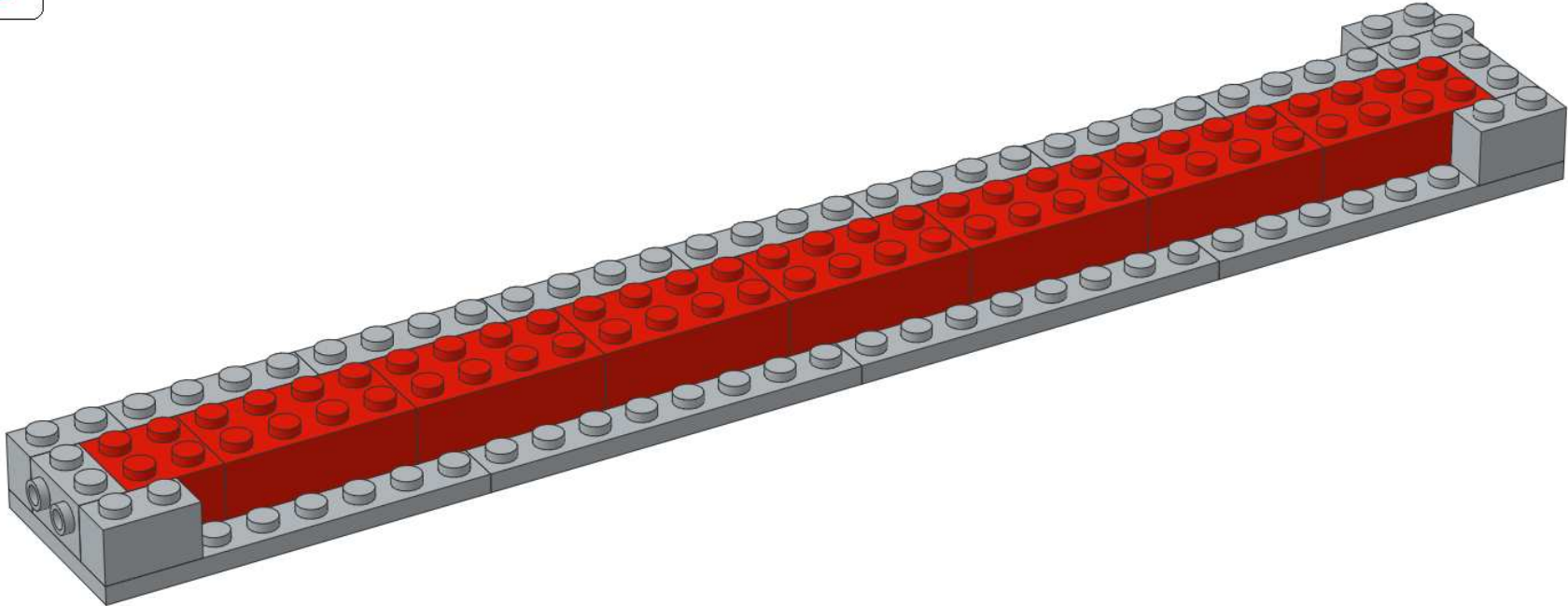

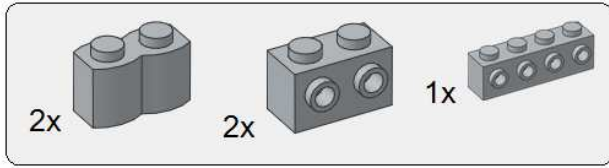

4

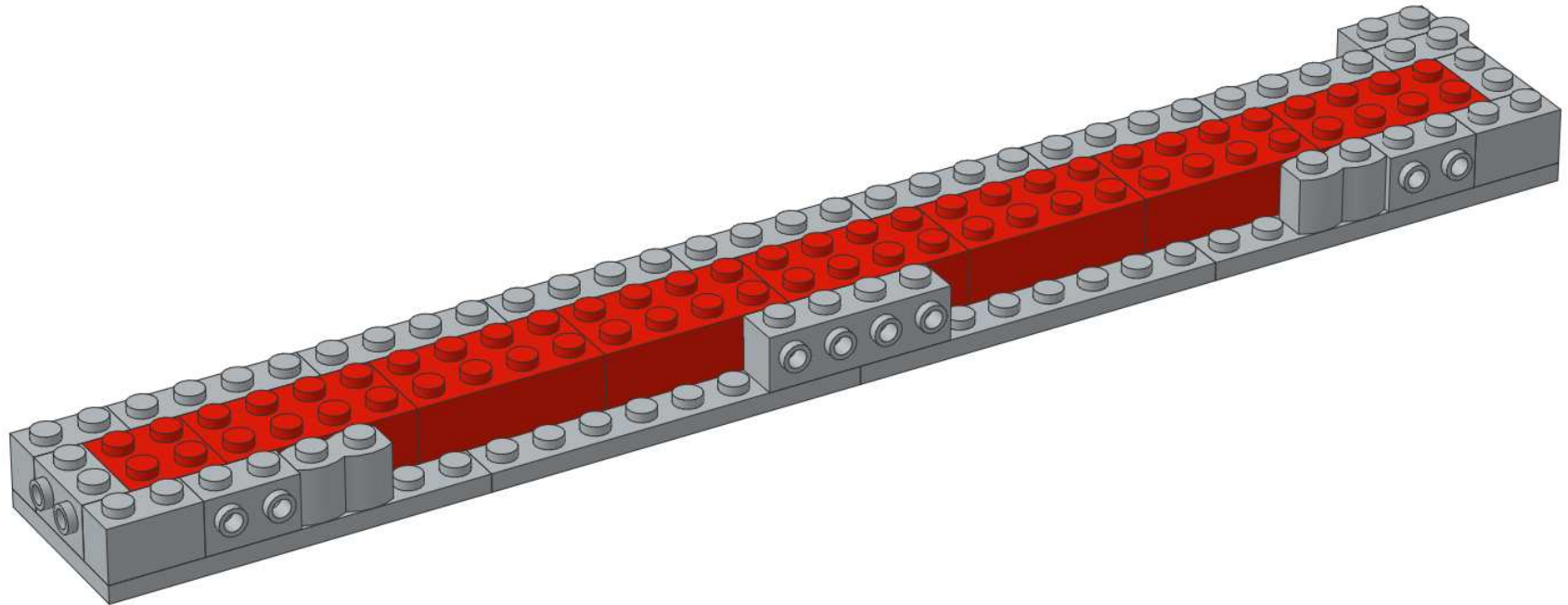

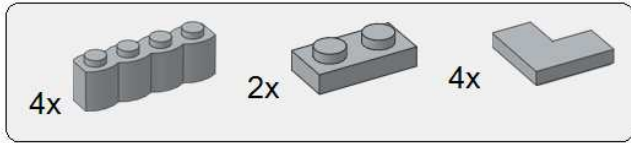

5

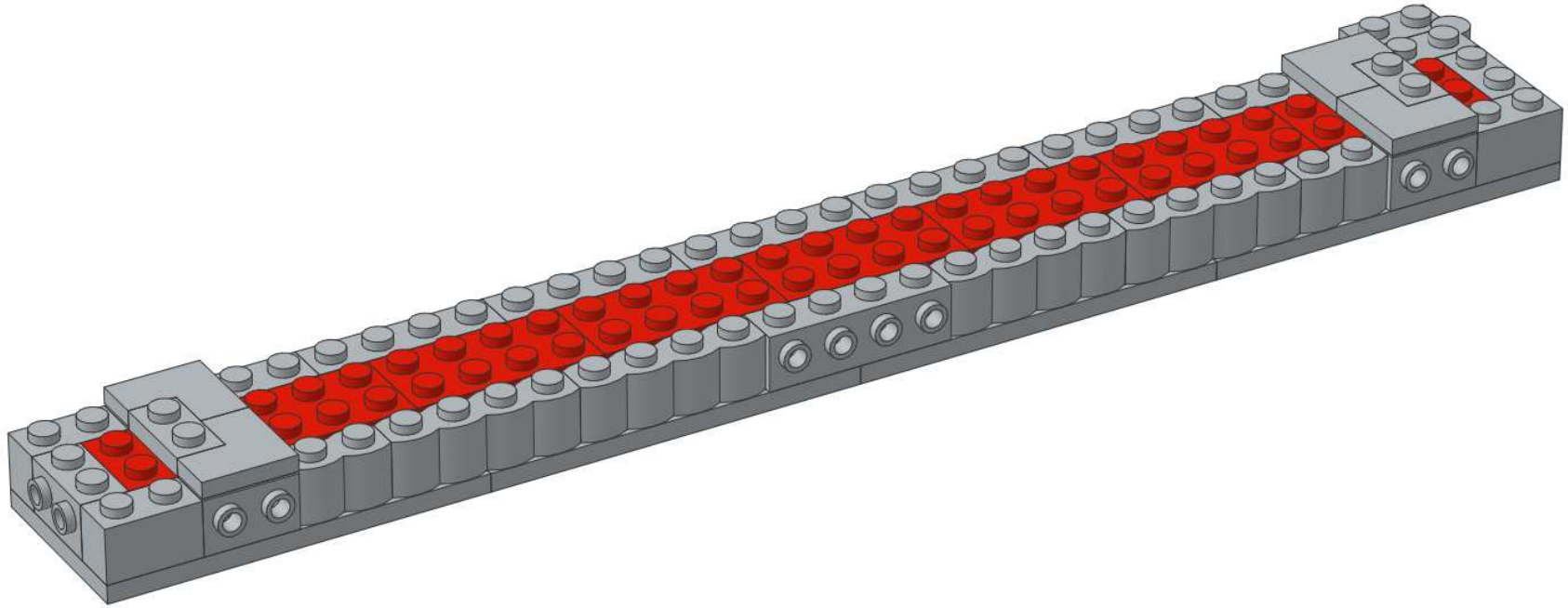

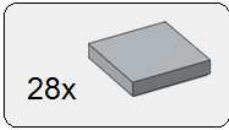

6

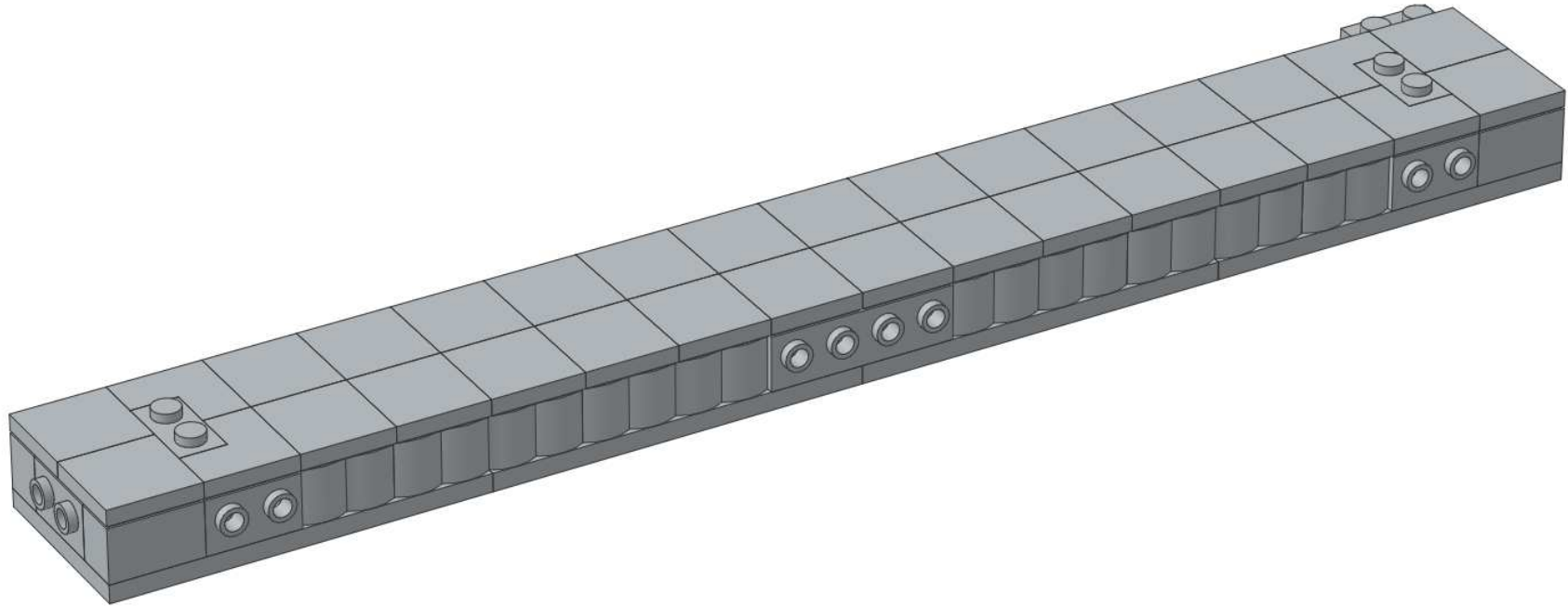

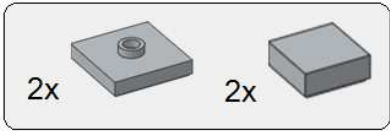

7

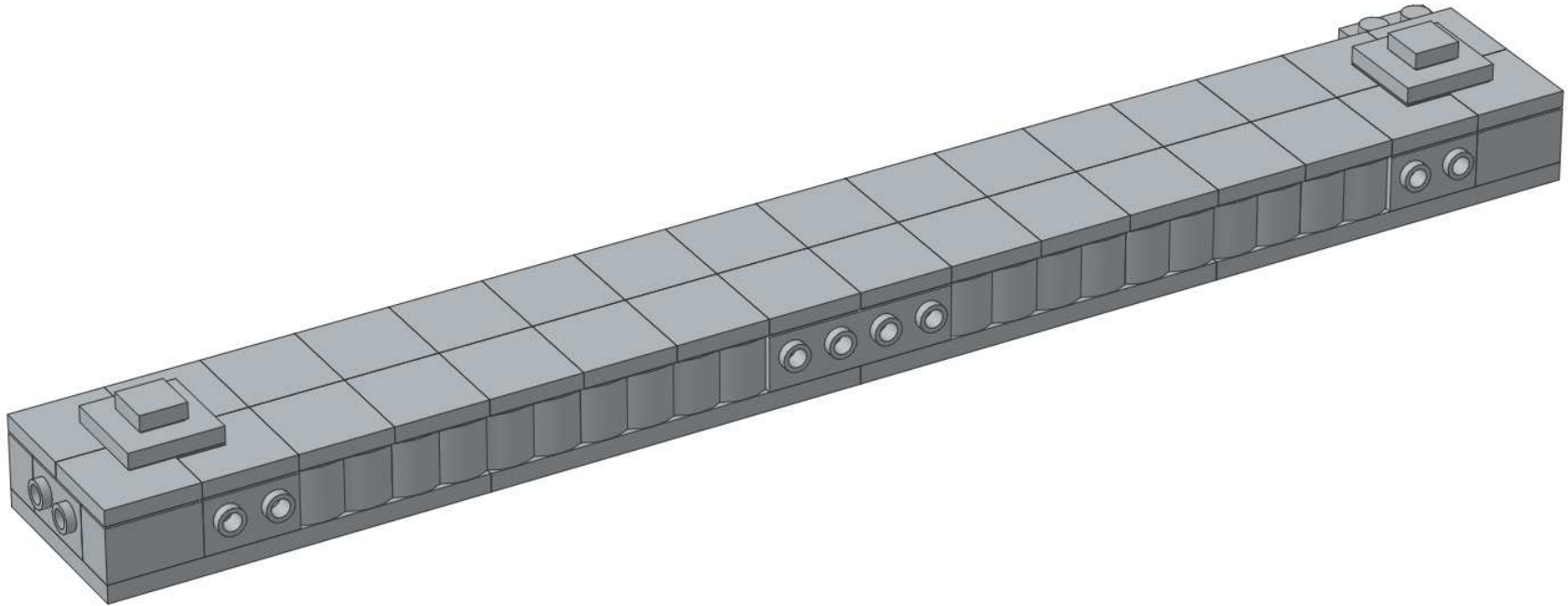



8

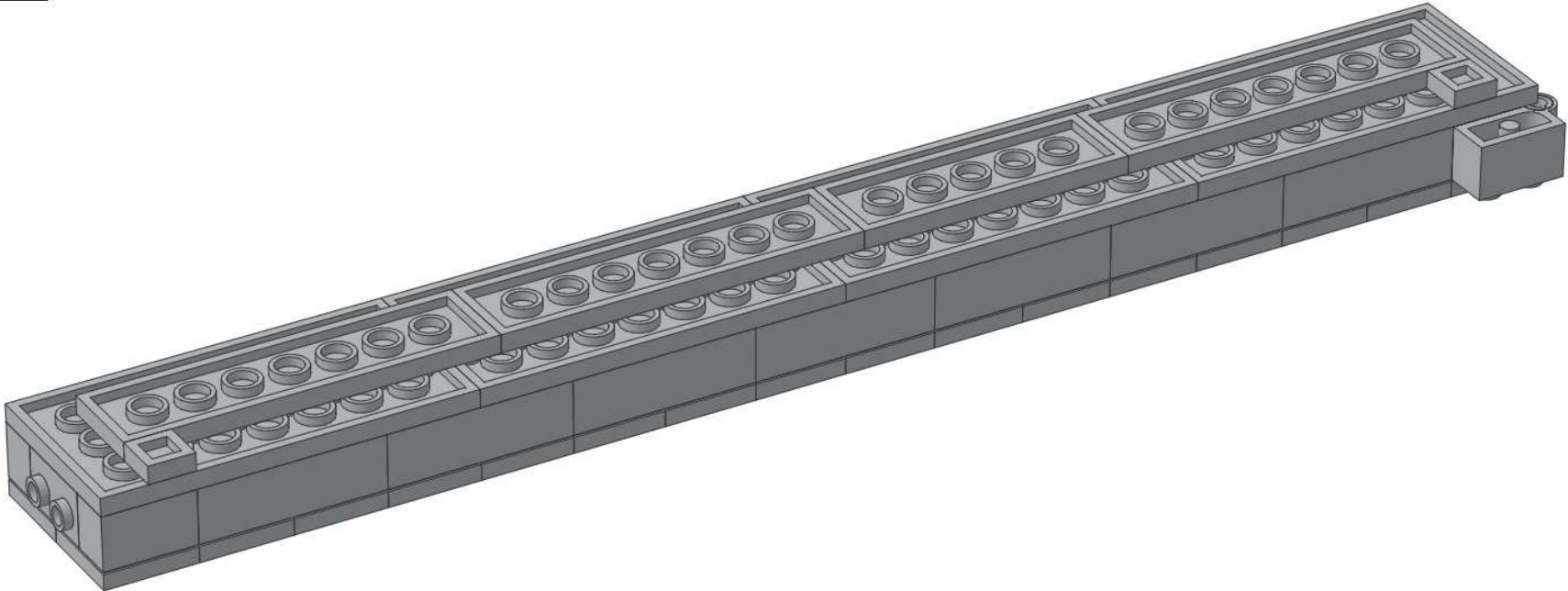

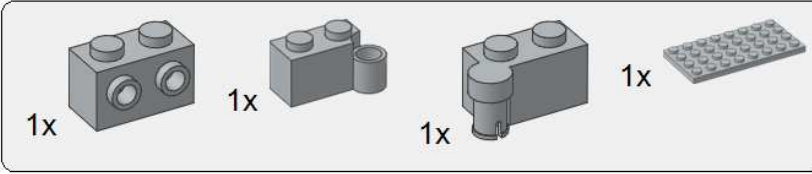
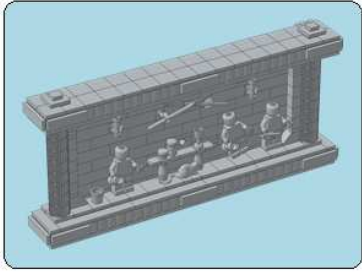

1

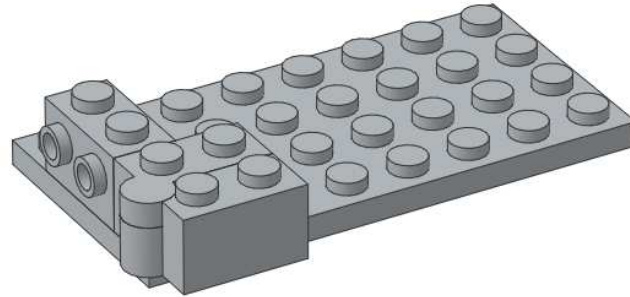

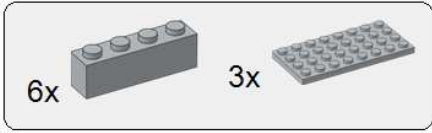

2

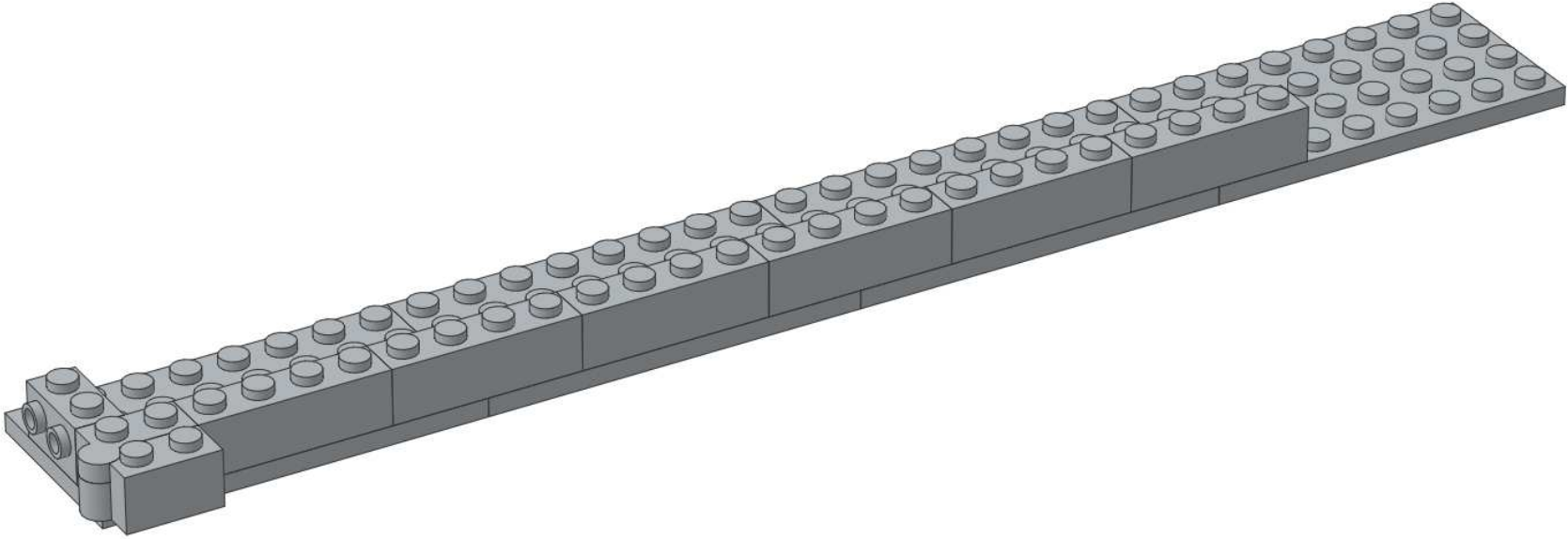

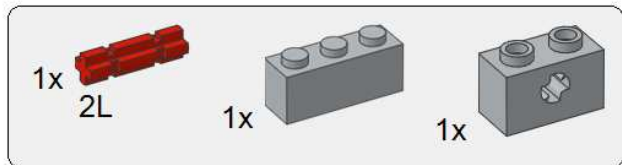

3

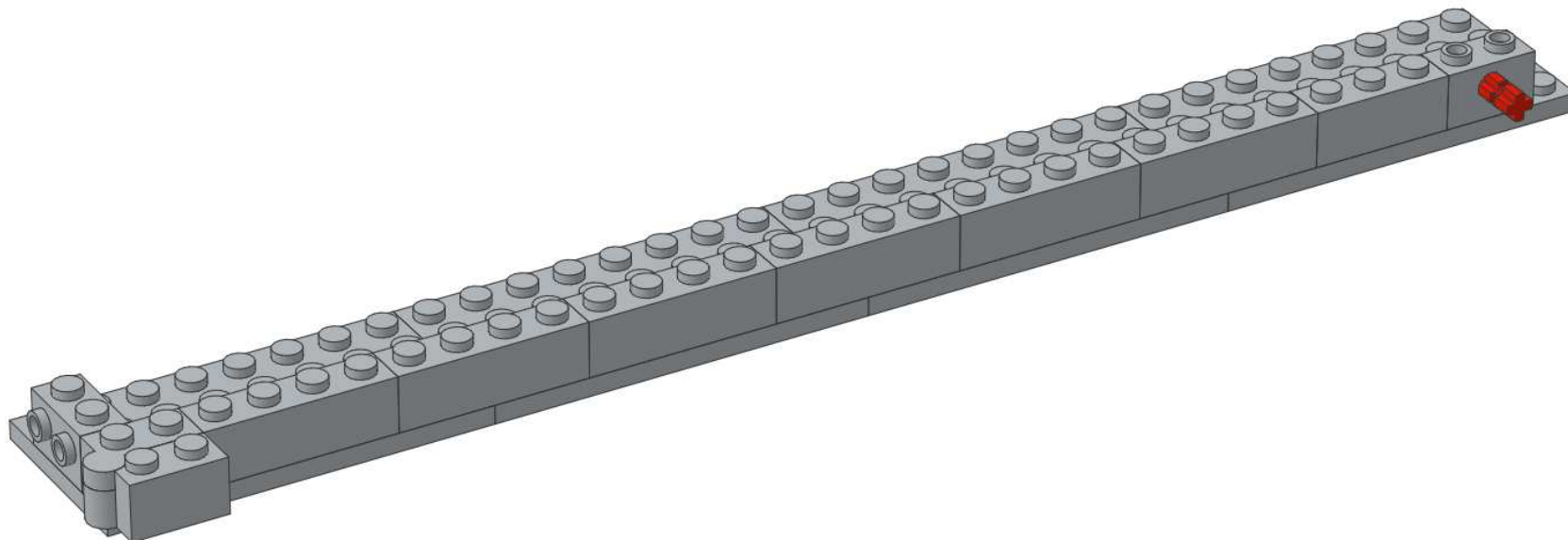

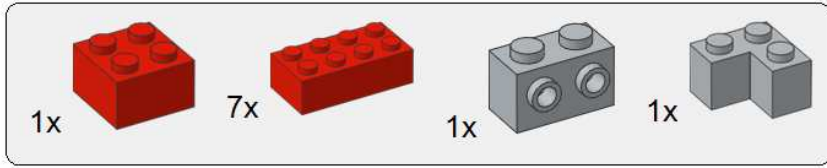

4

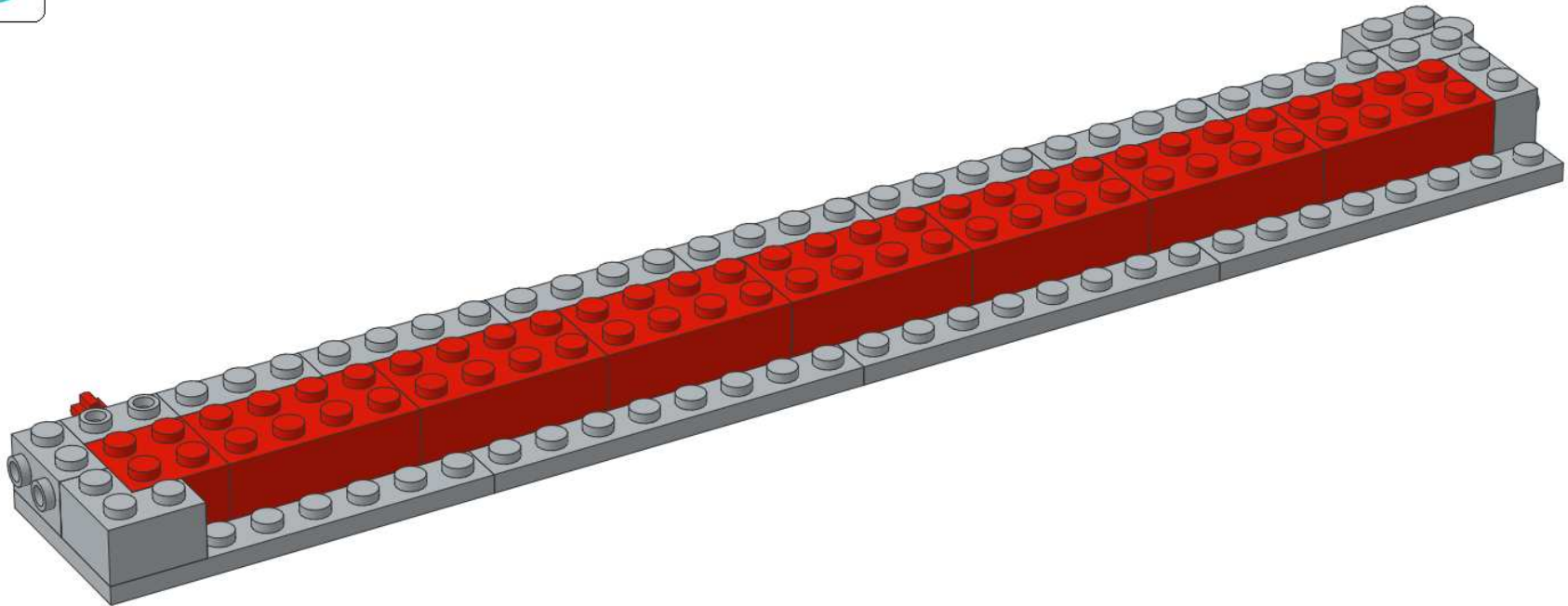

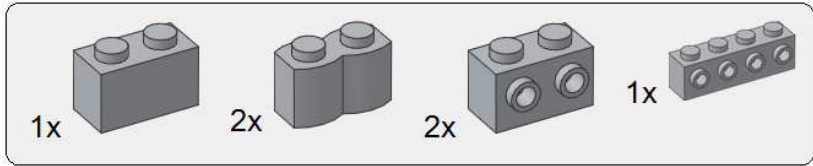

5

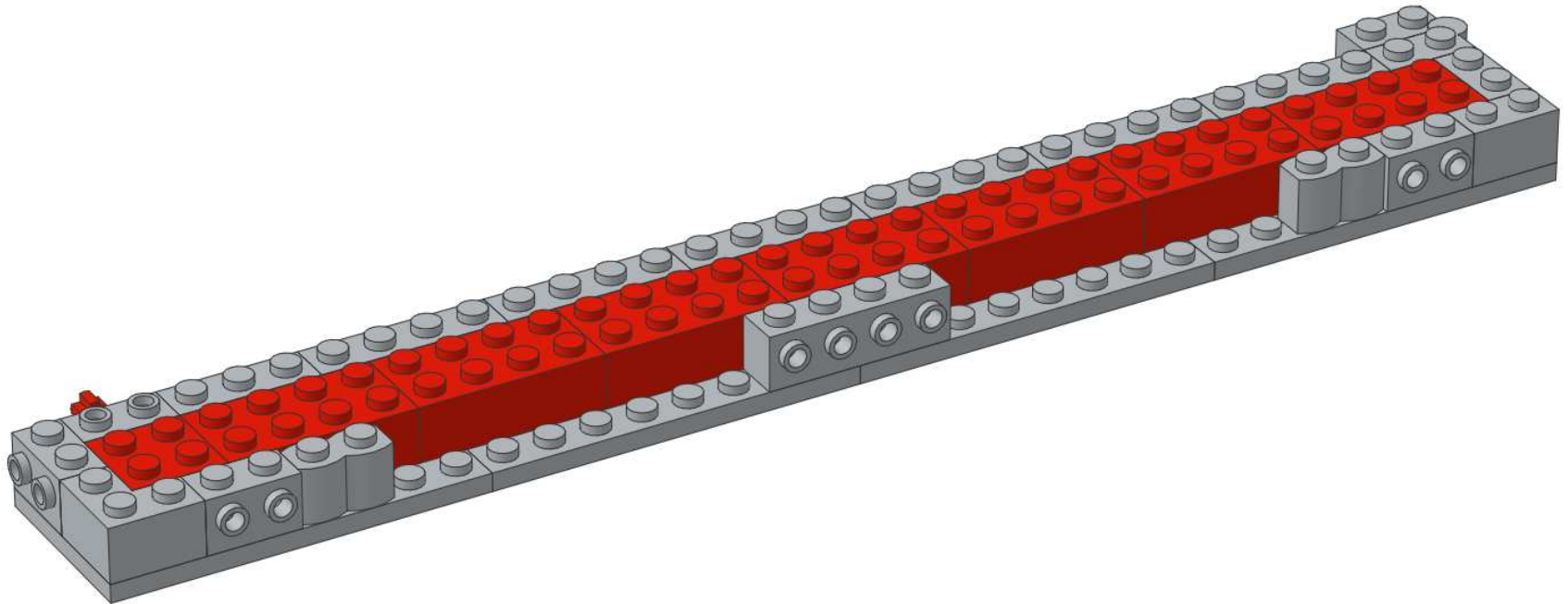

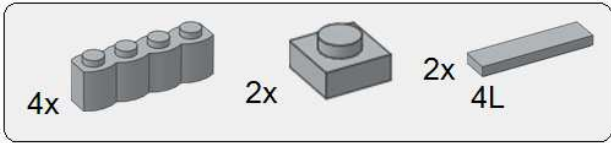

6

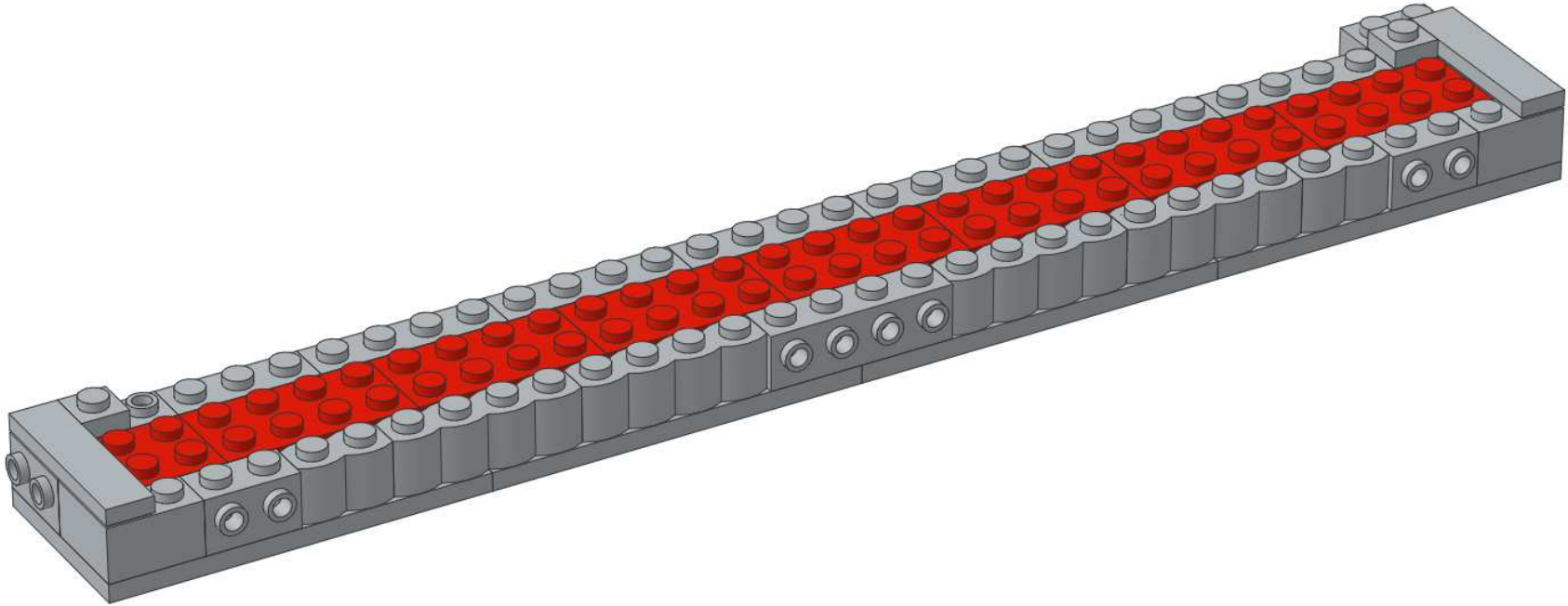



7

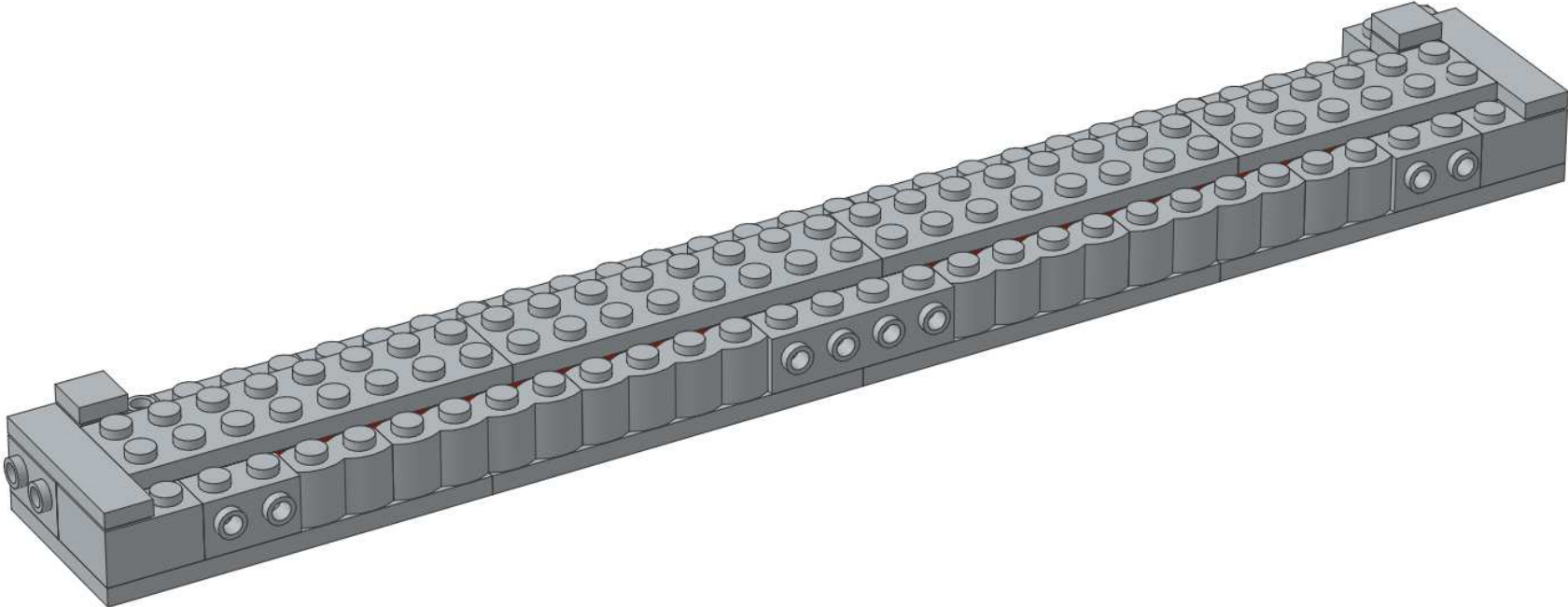

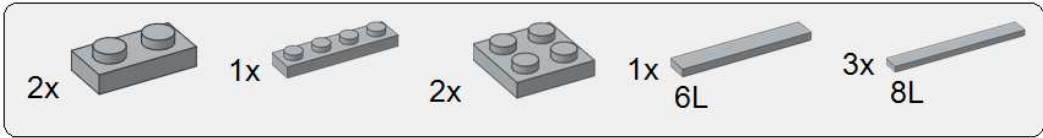

8

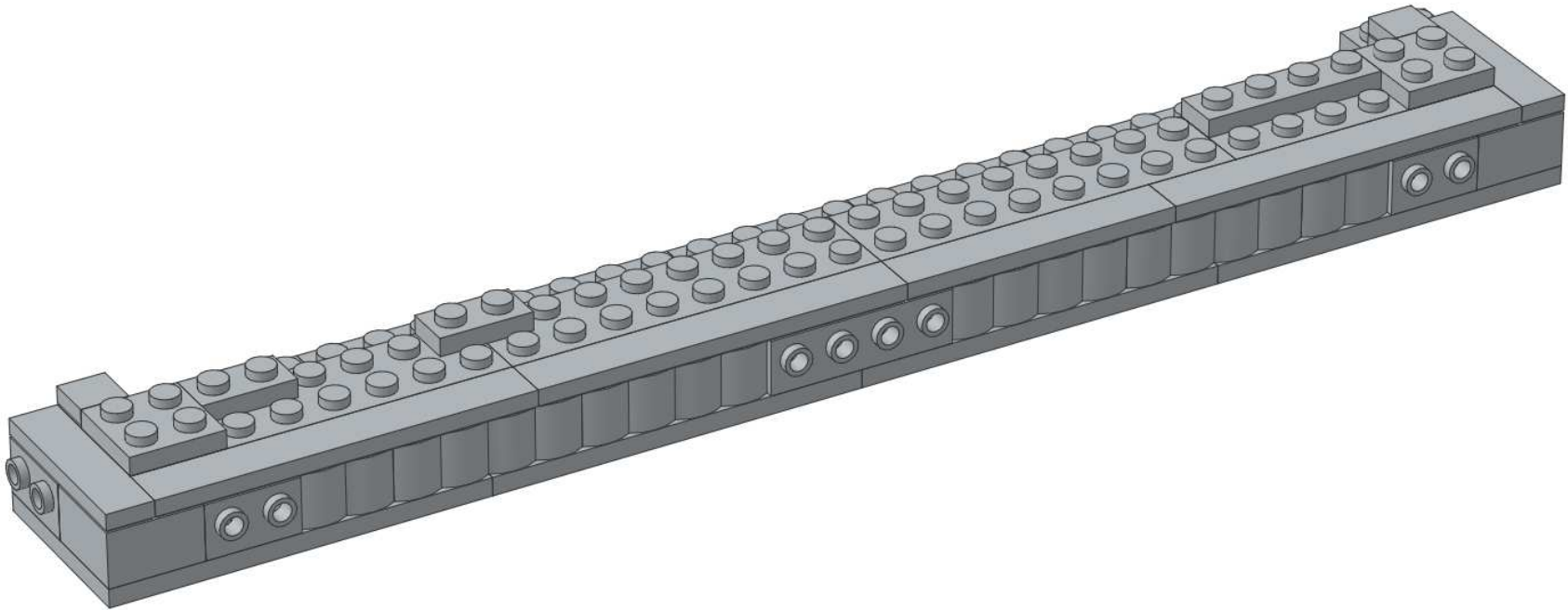

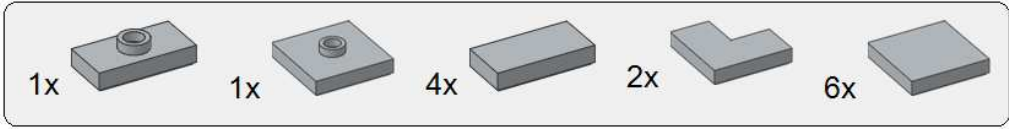

9

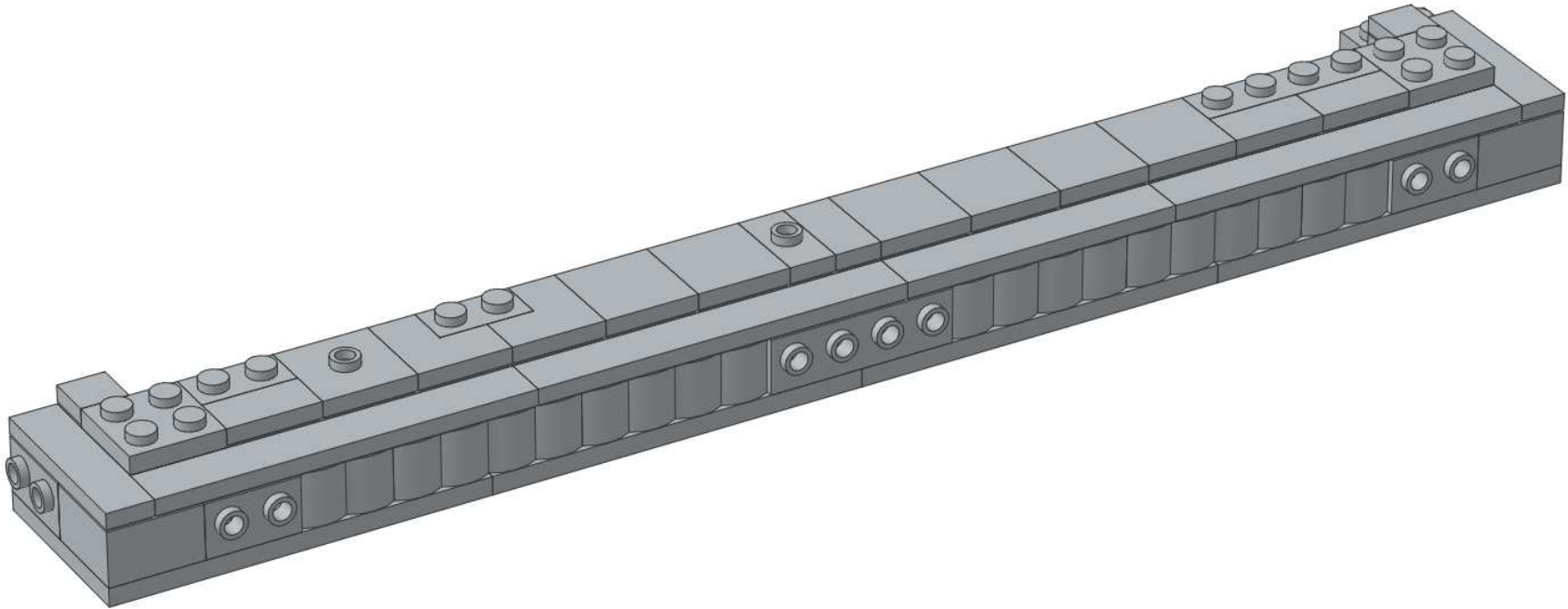

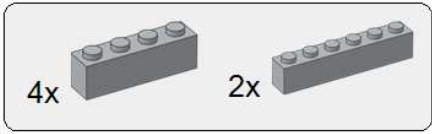

10

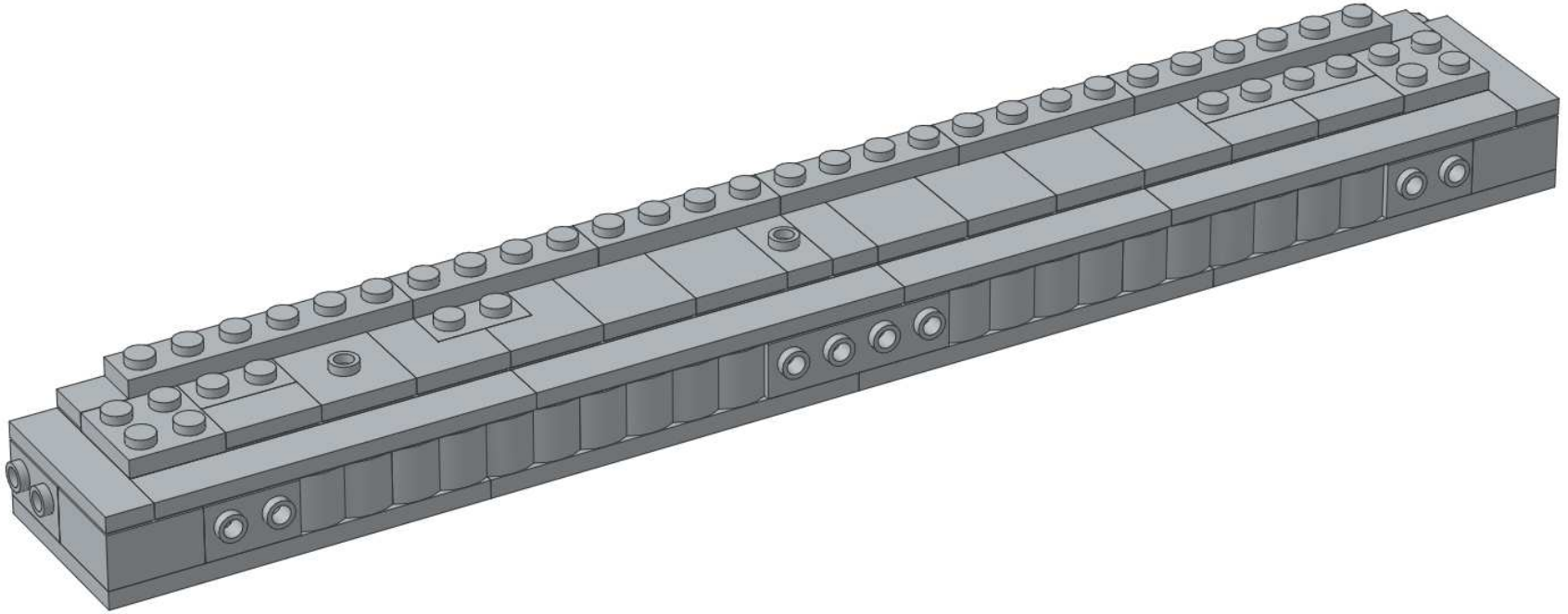

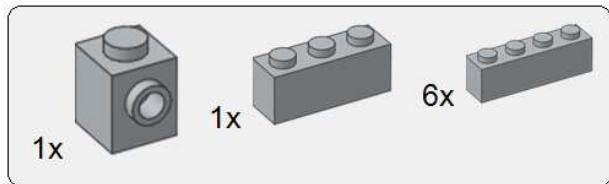

11

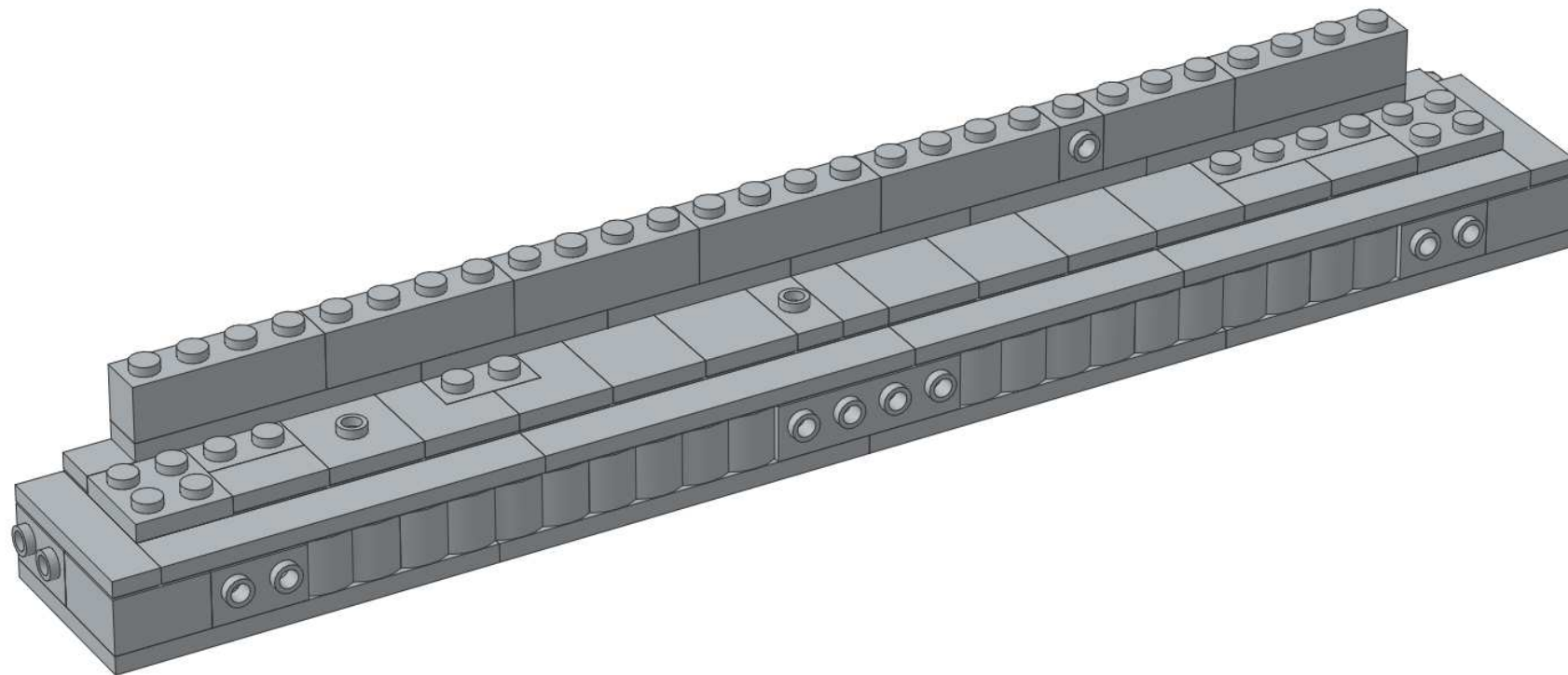

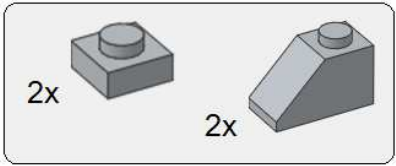

12

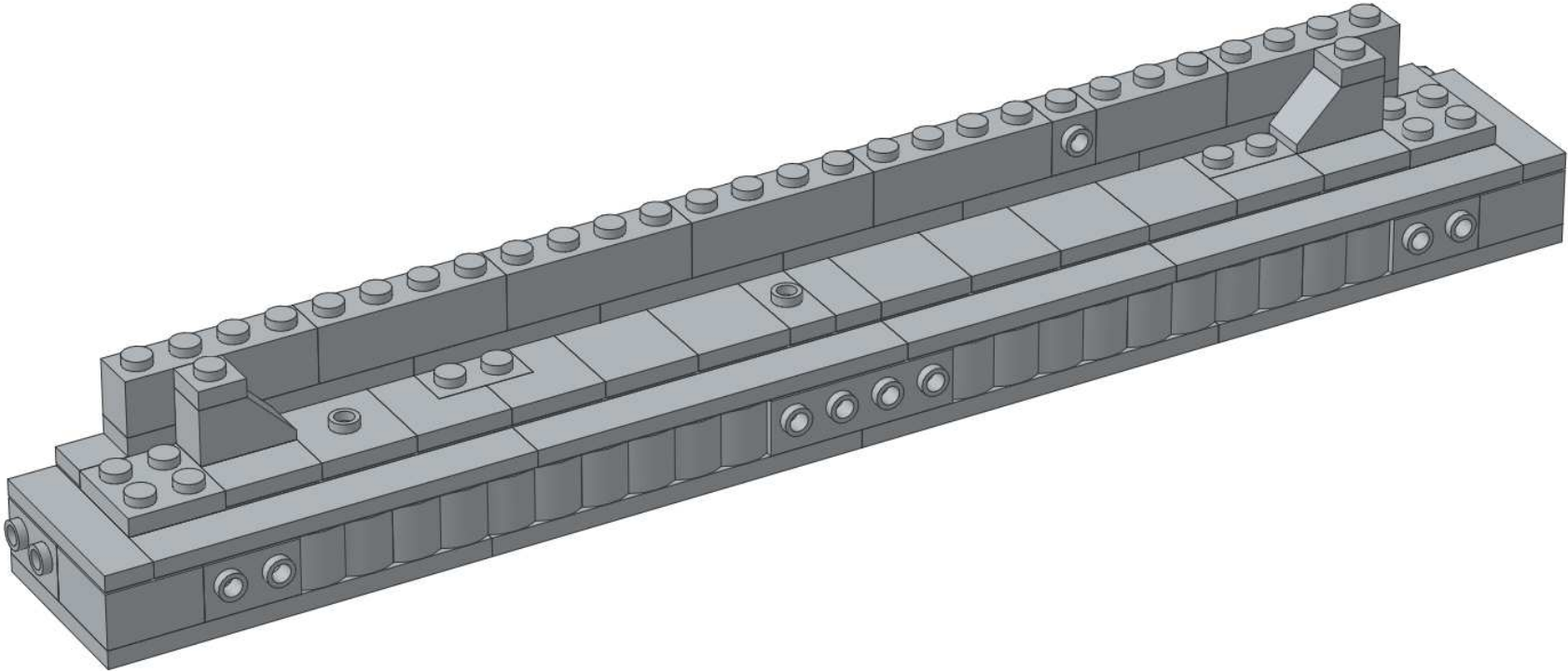

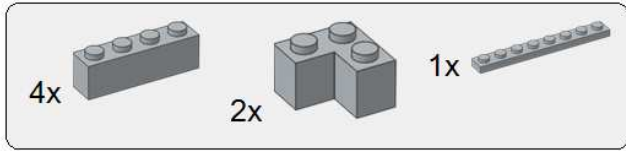

13

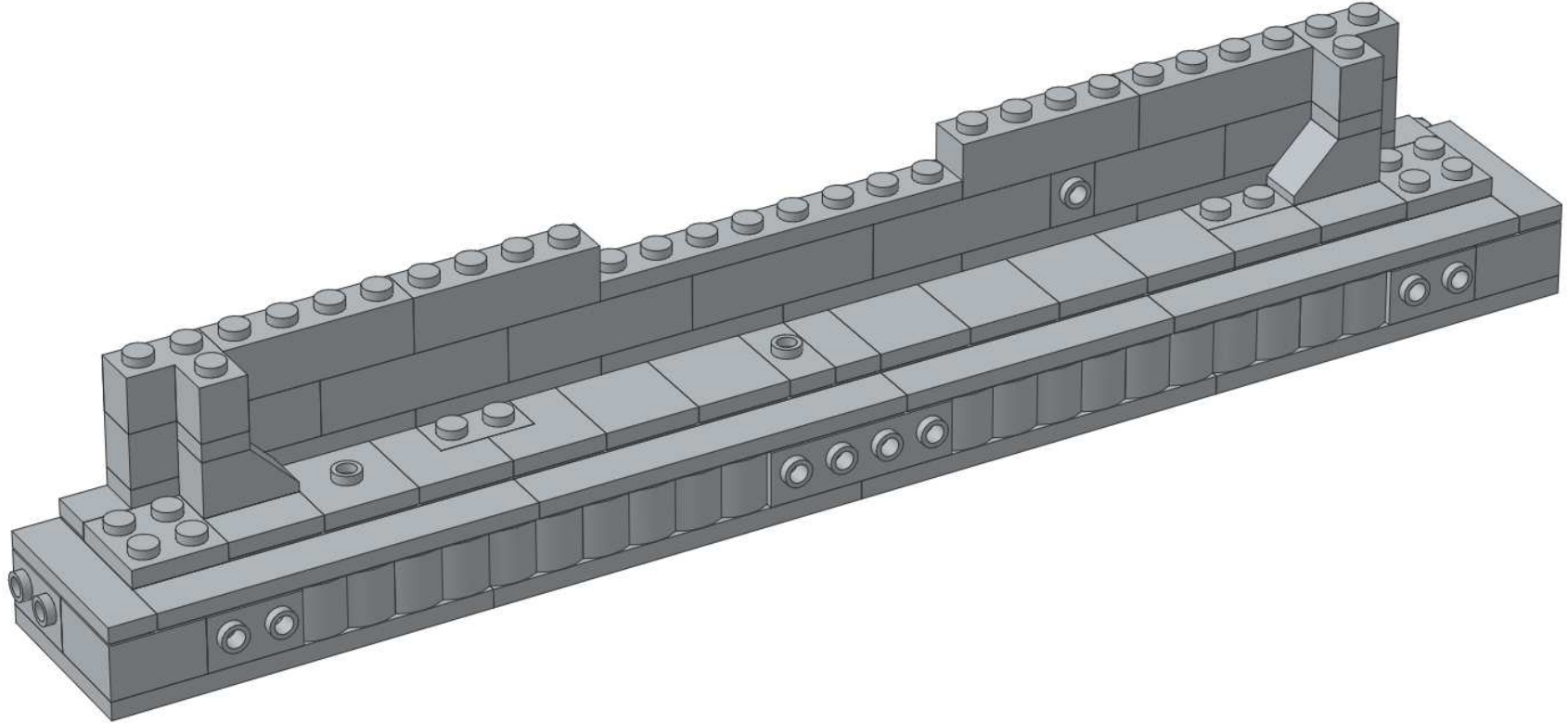

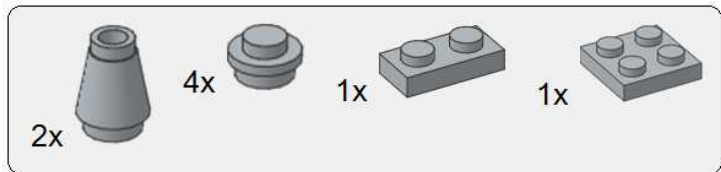

14

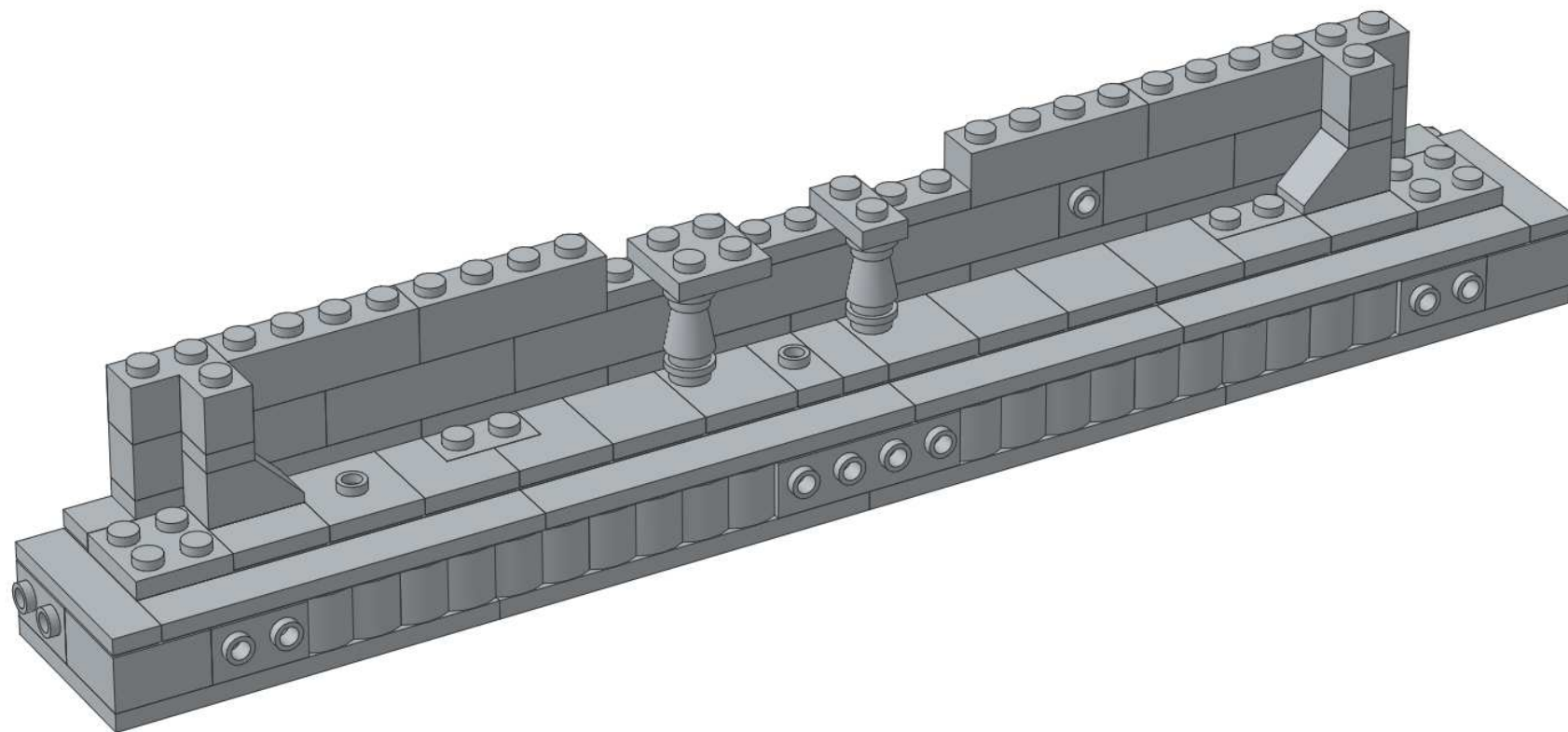

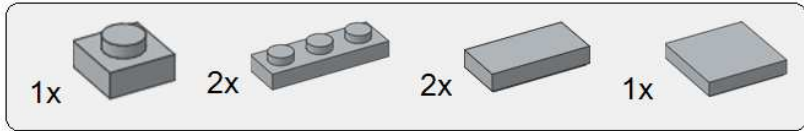

15

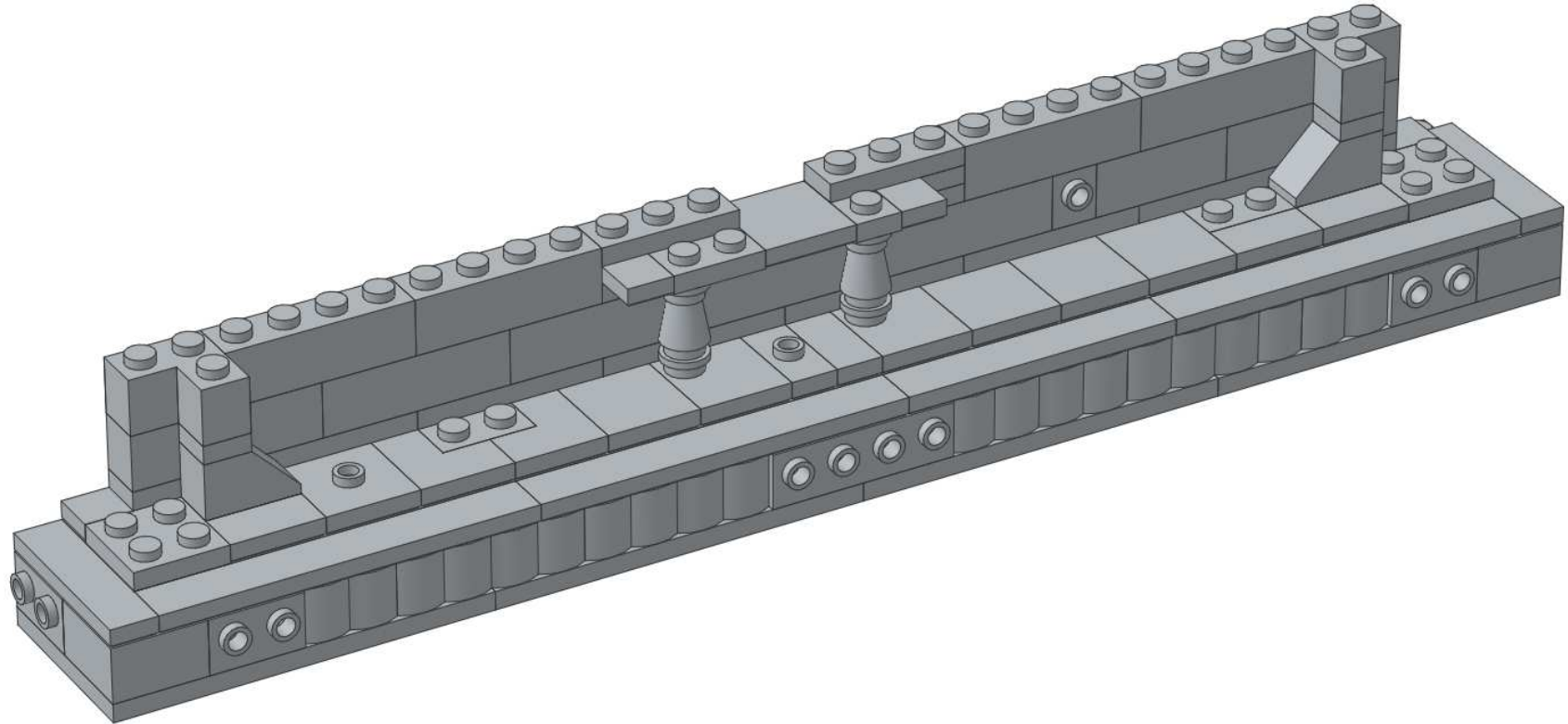

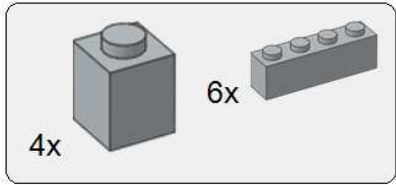

16

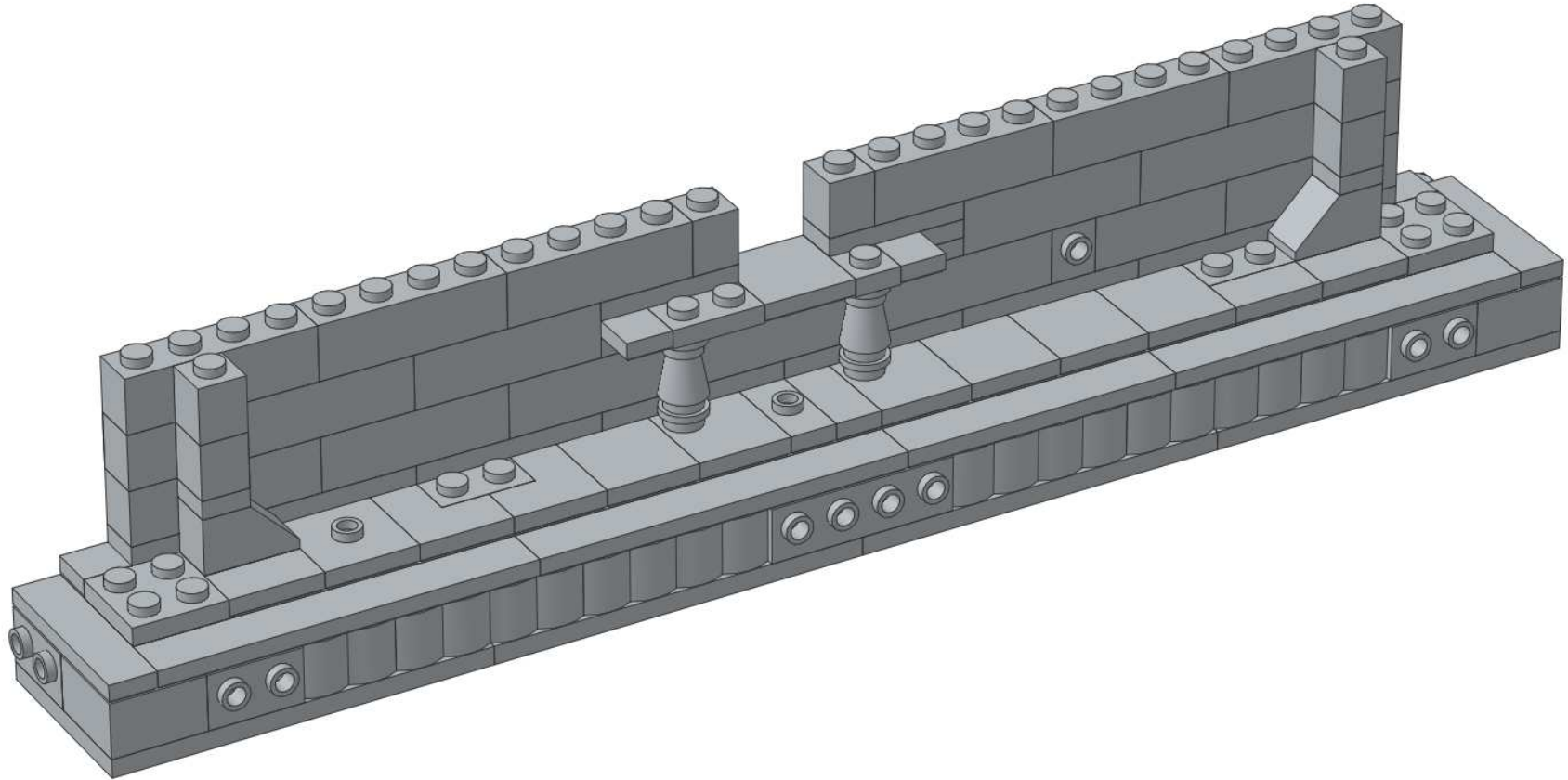

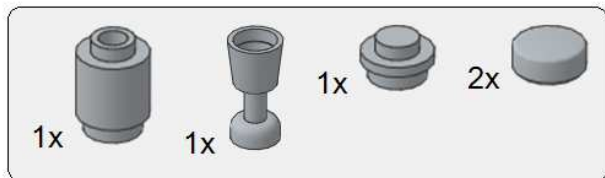

17

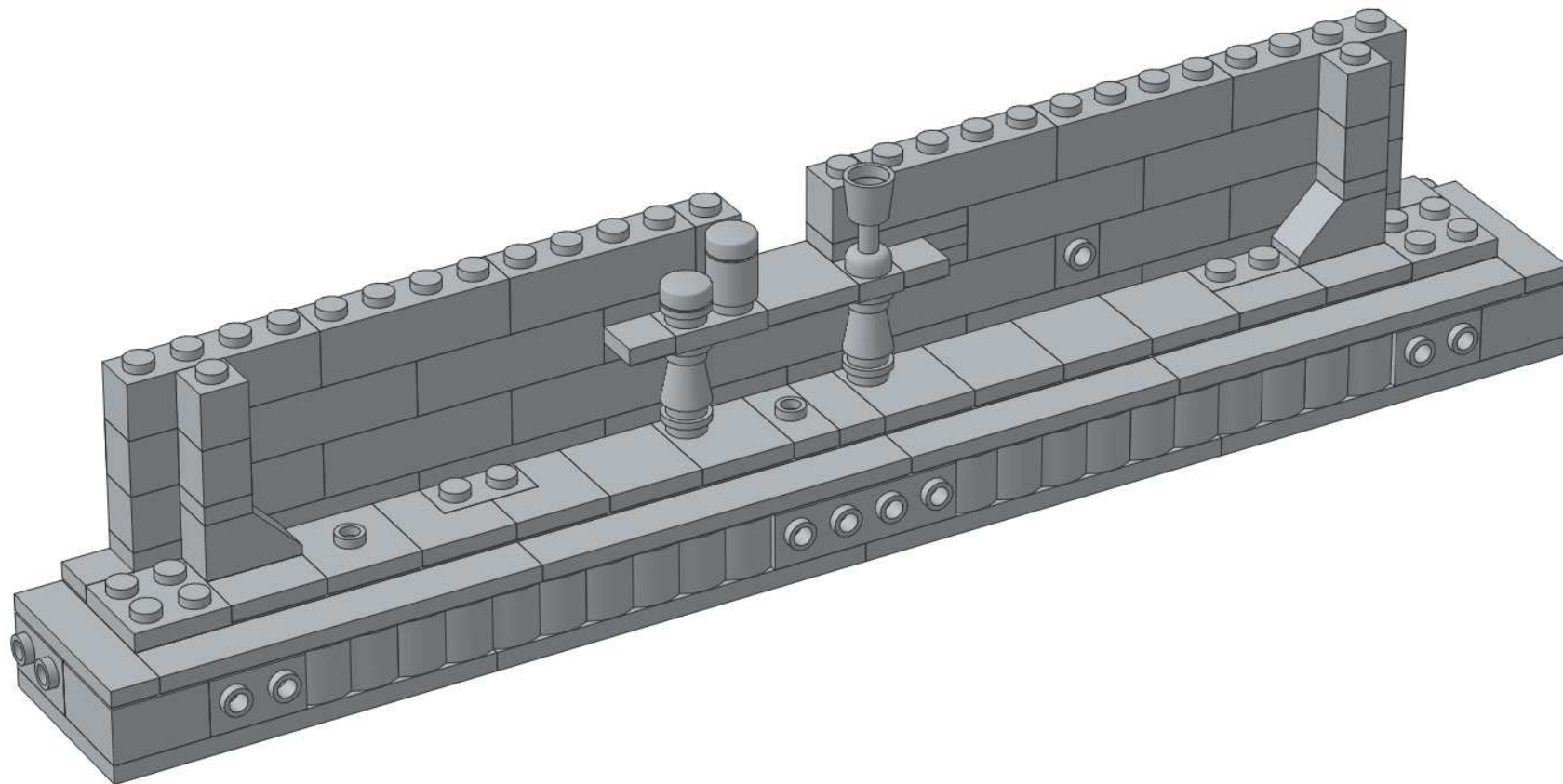

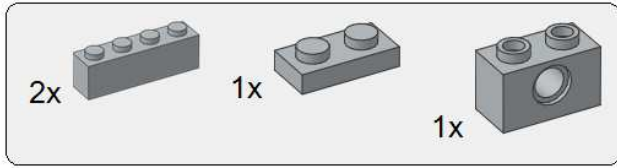

18

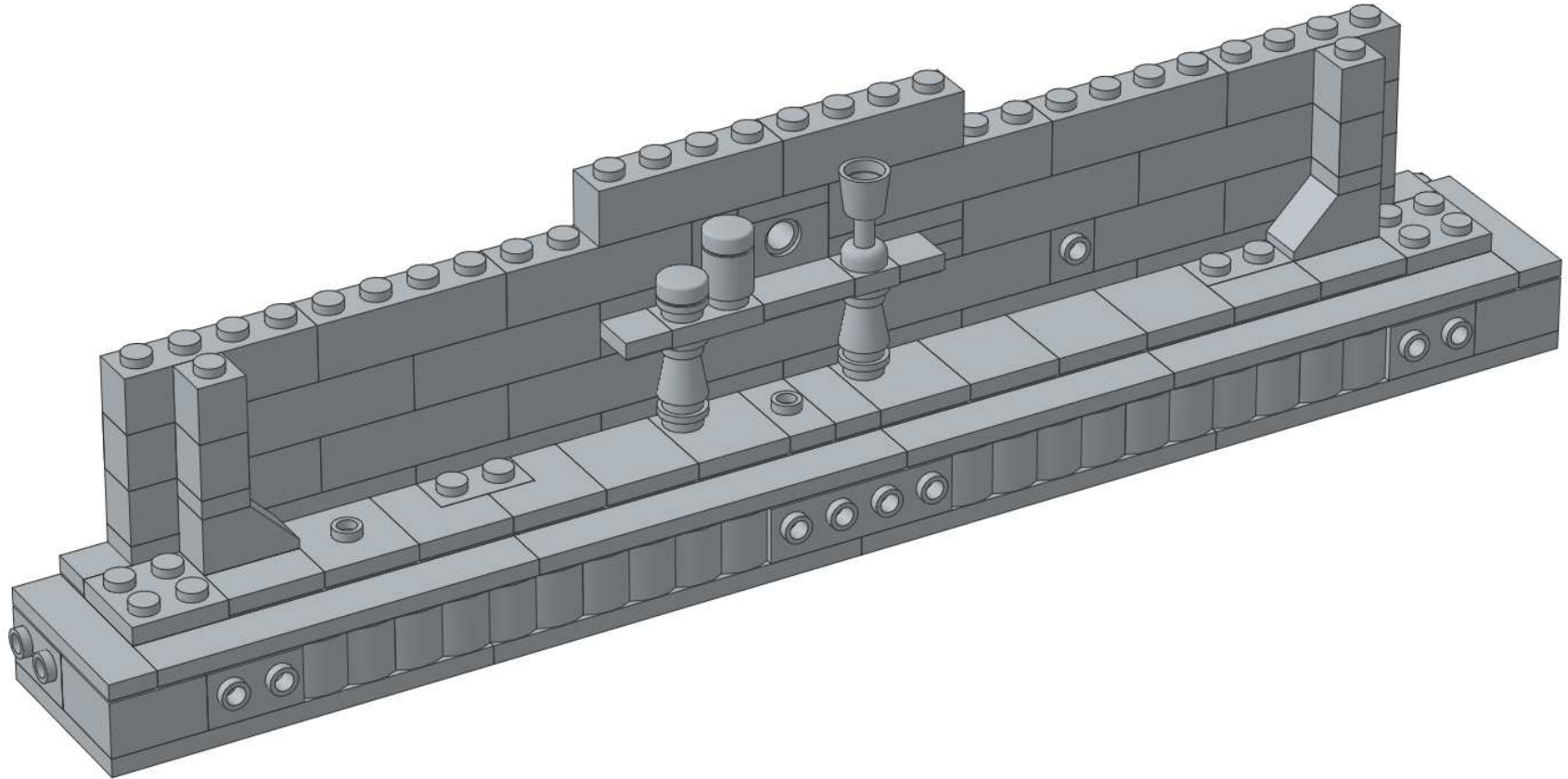

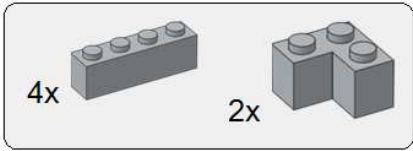

19

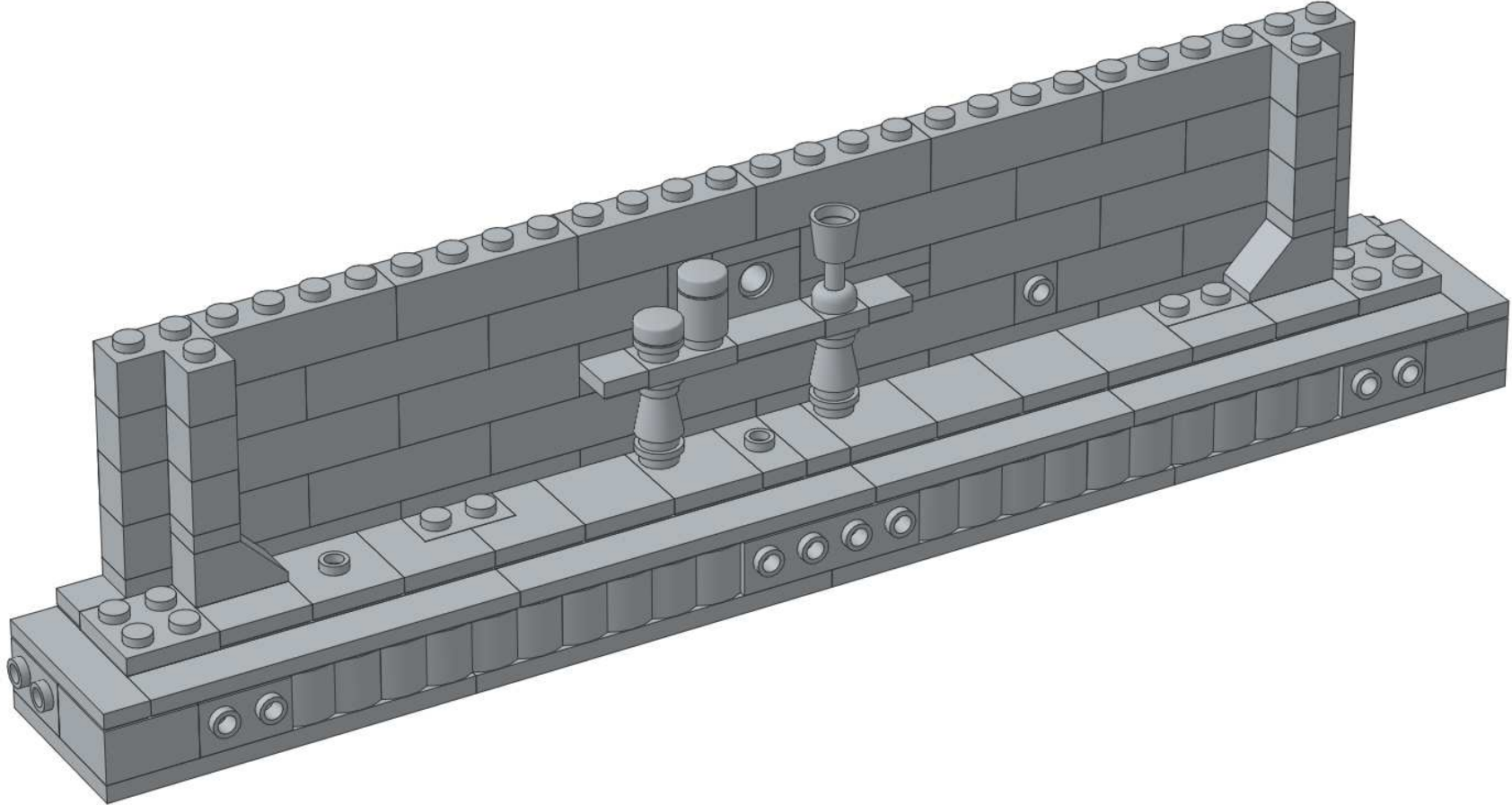

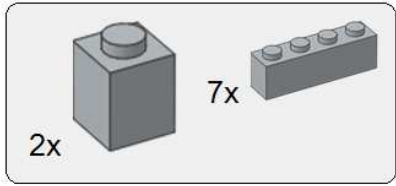

20

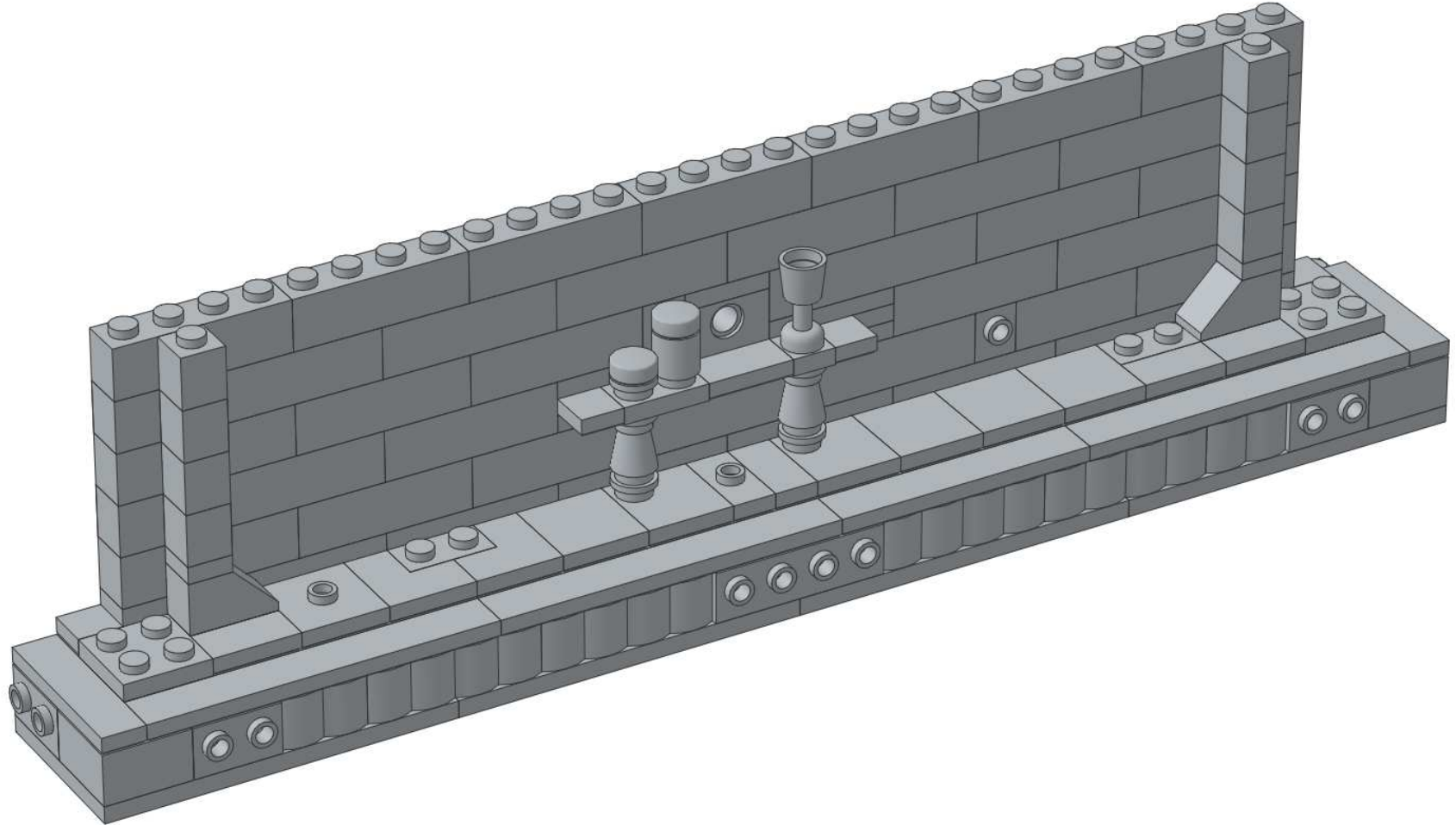

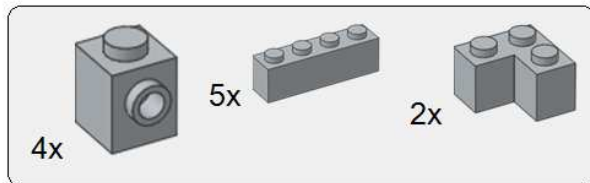

21

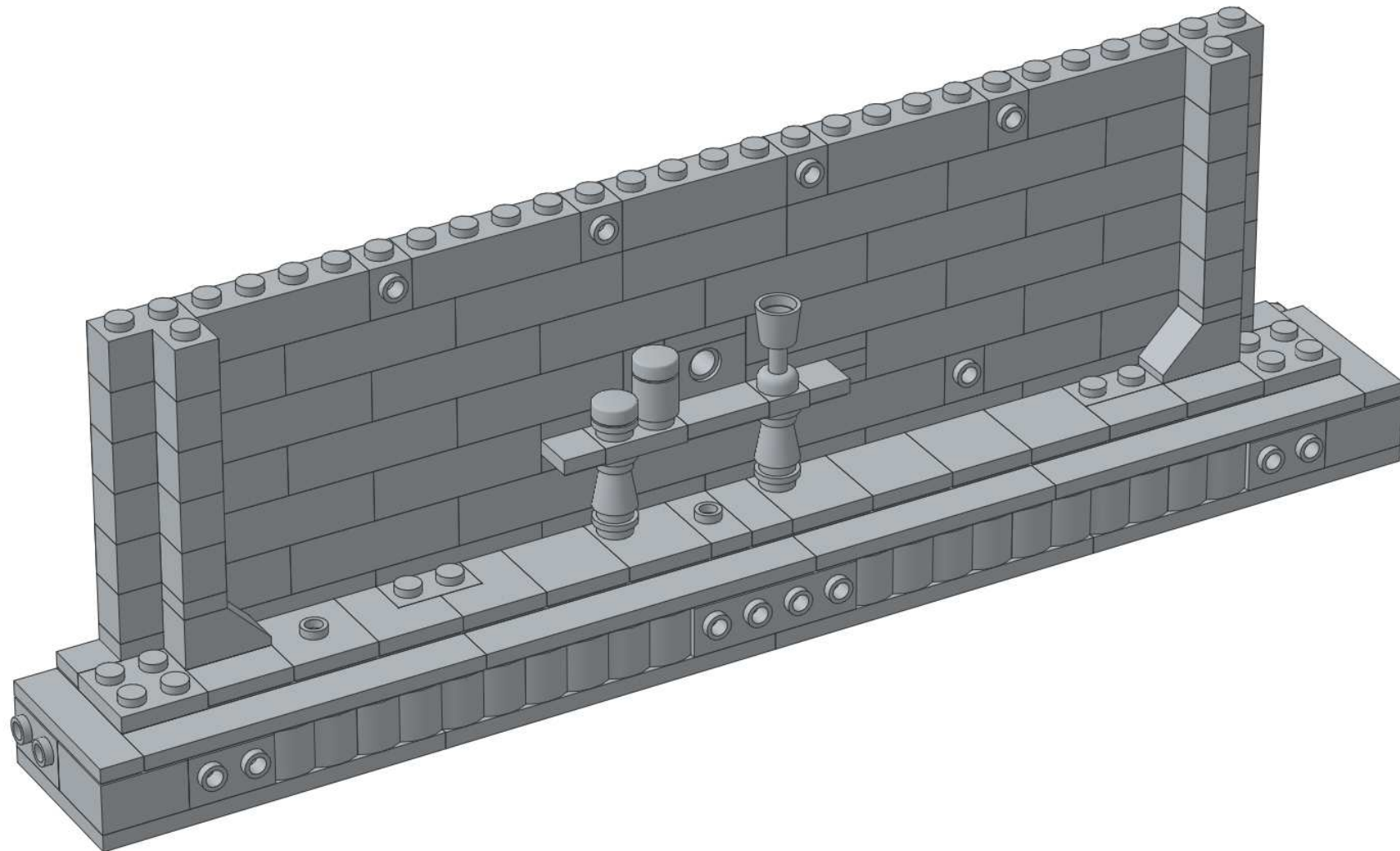

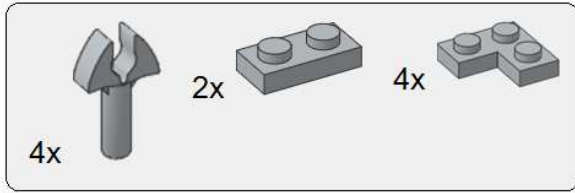

22

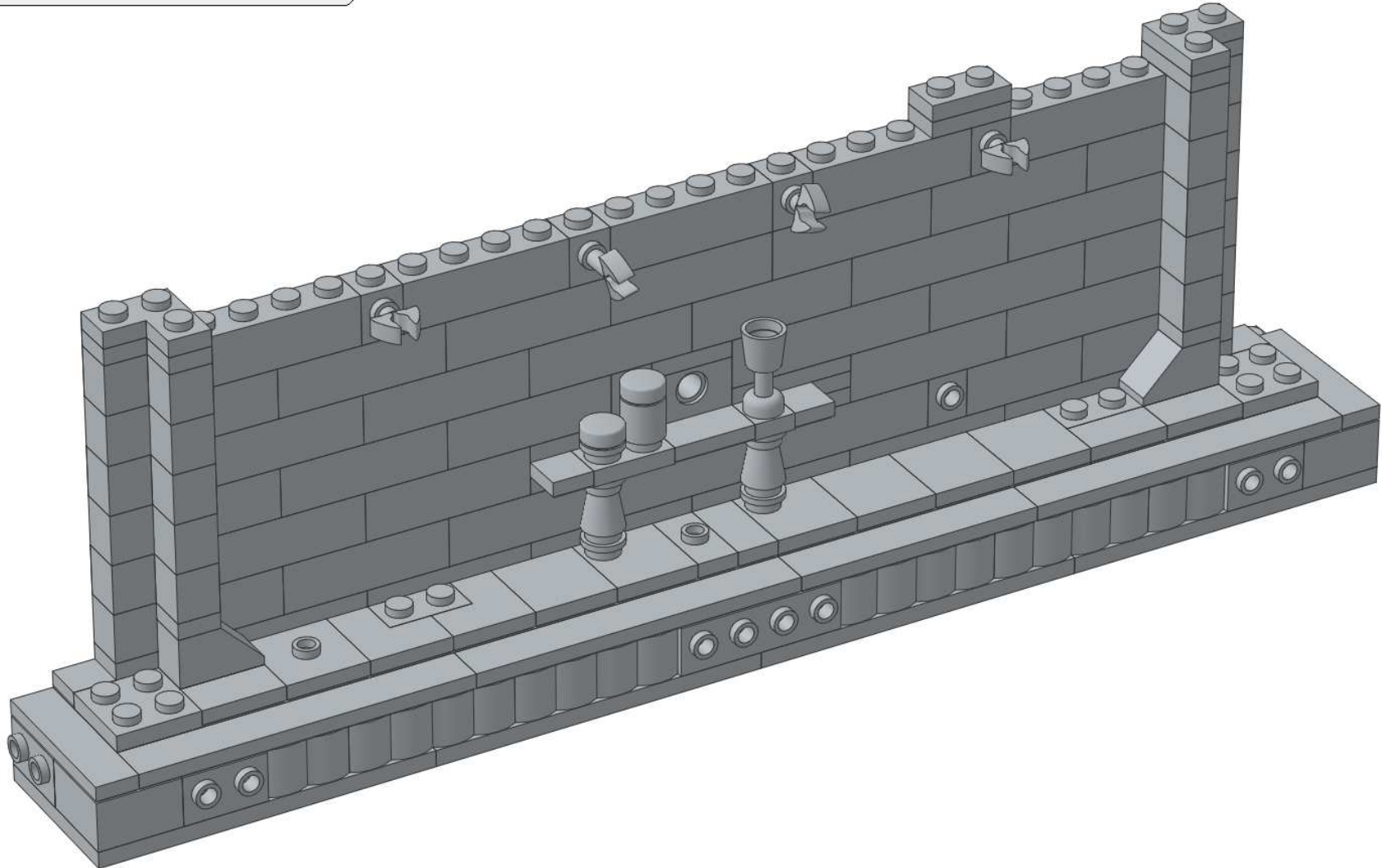

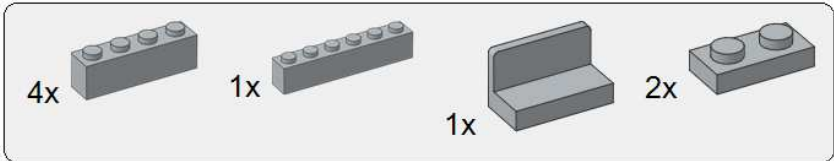

23

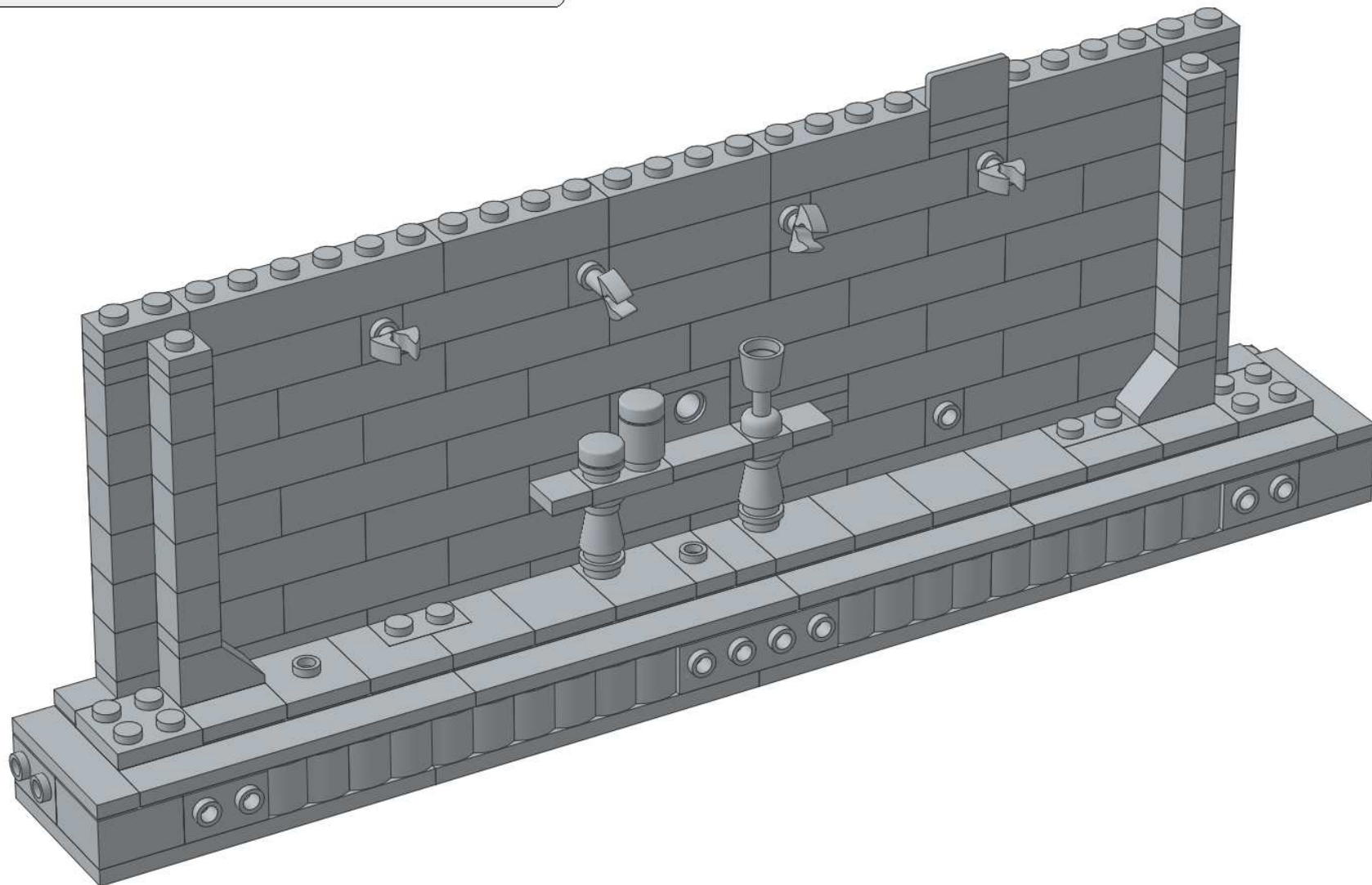

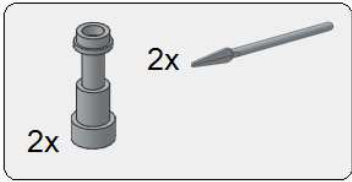

24

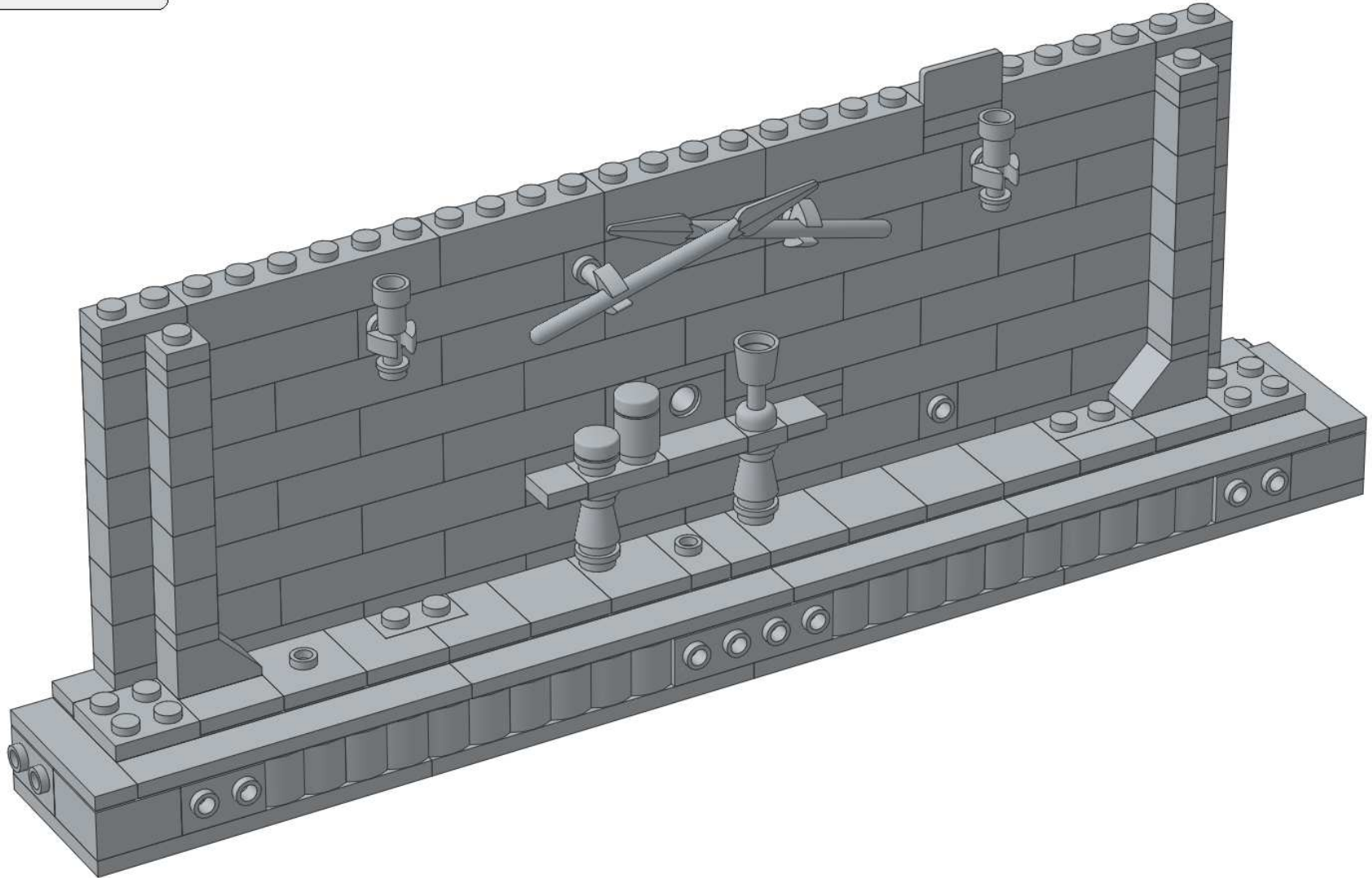

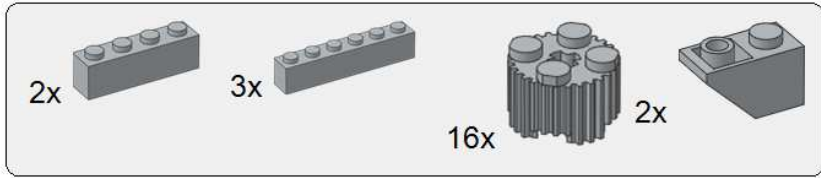

25

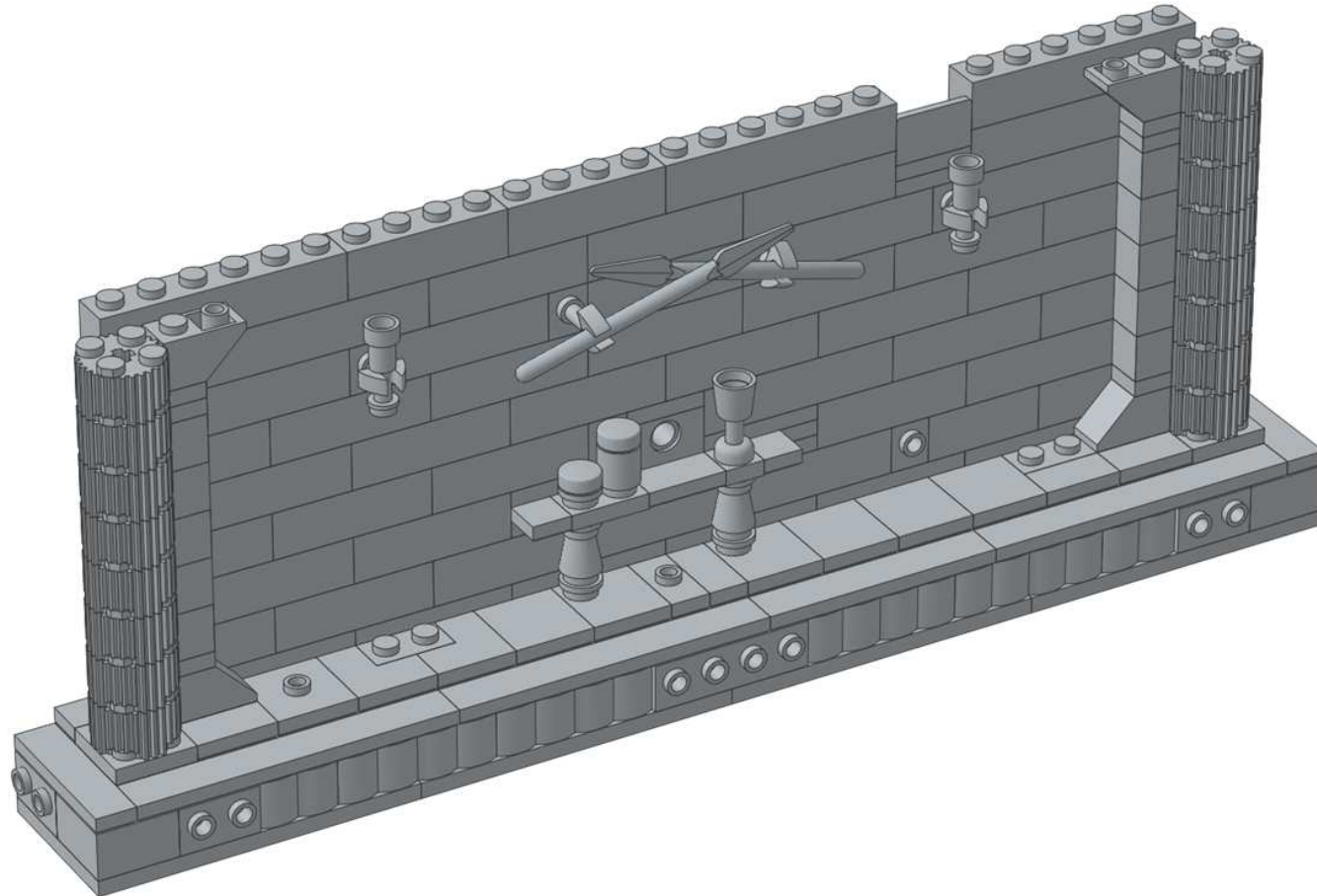



26

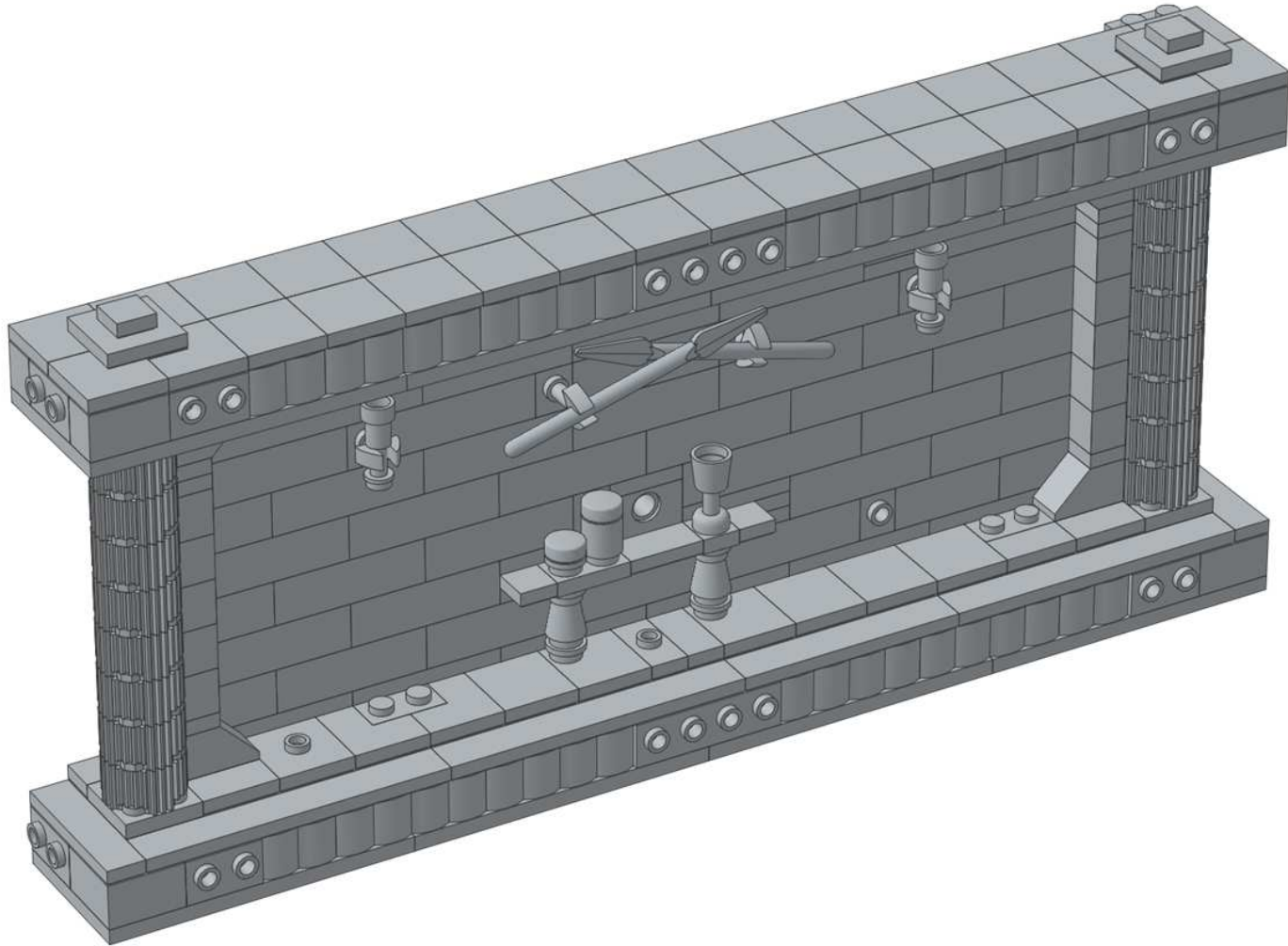

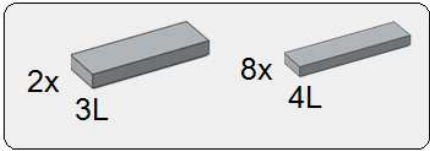

27

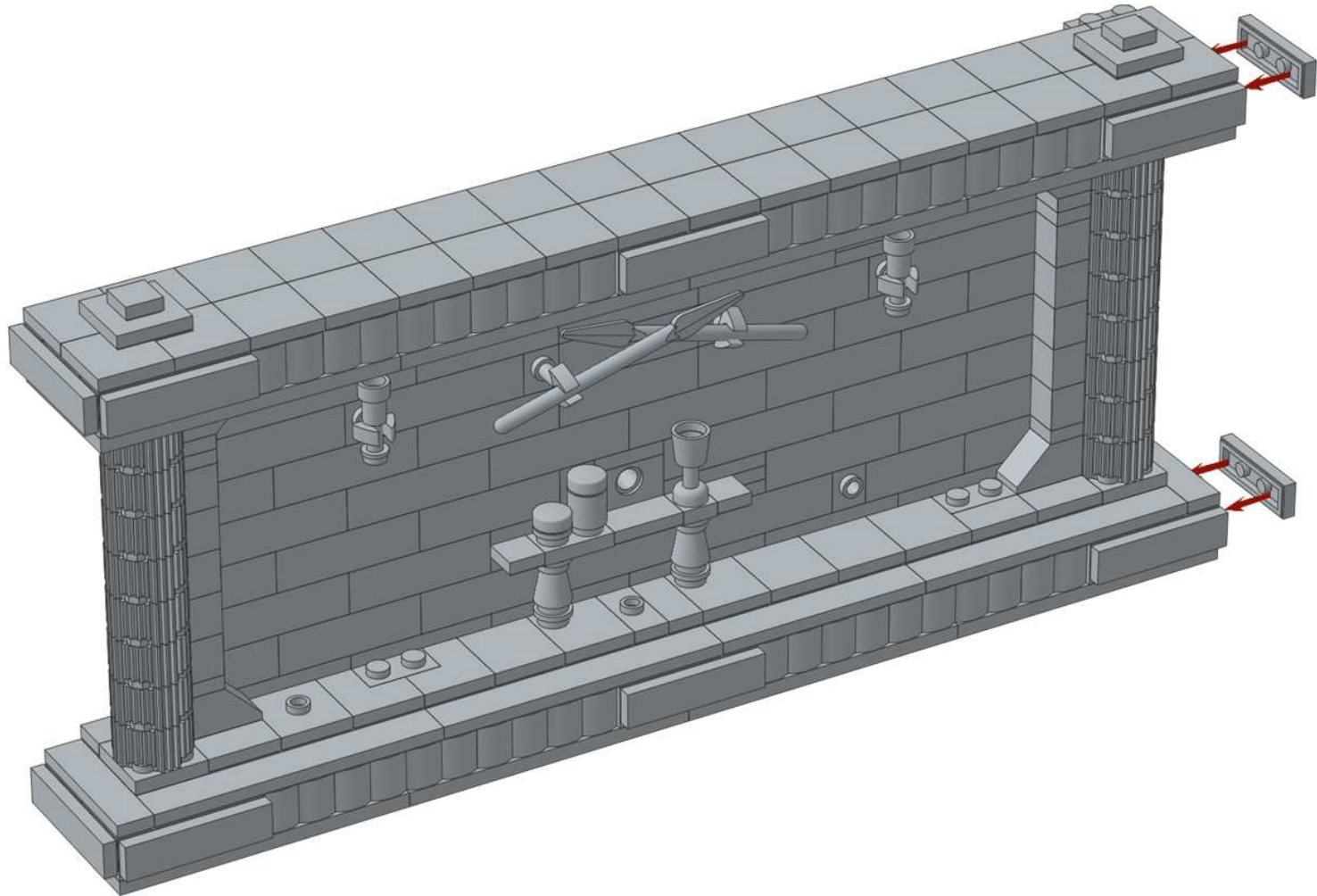

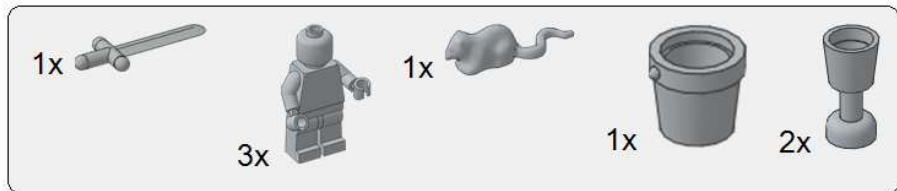

28

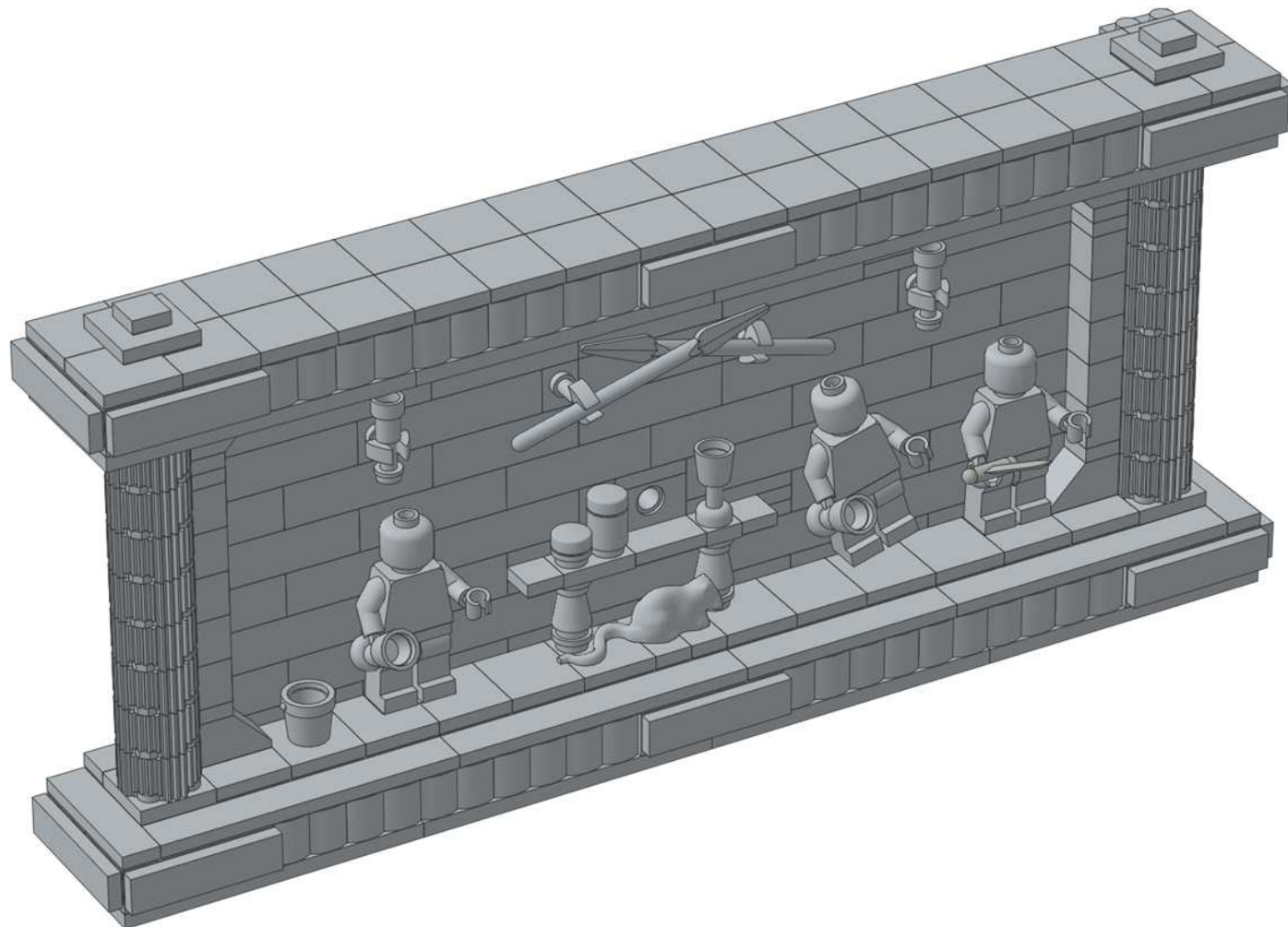

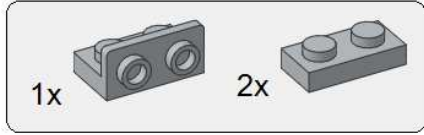
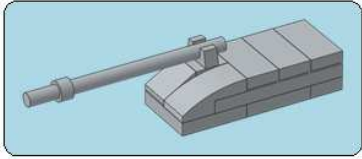

1

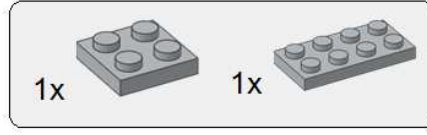
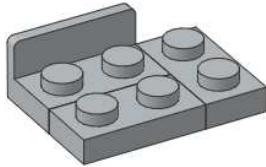

2

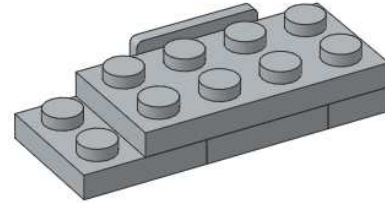

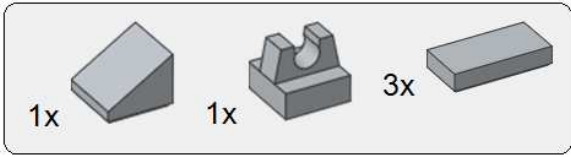

3

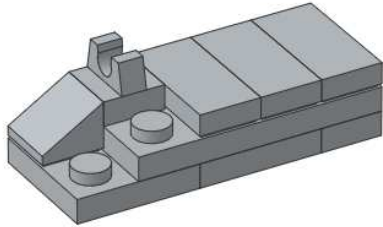

4

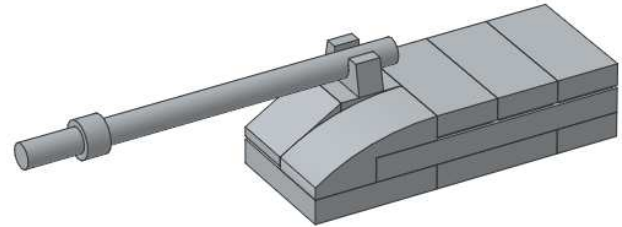

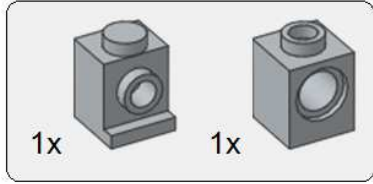
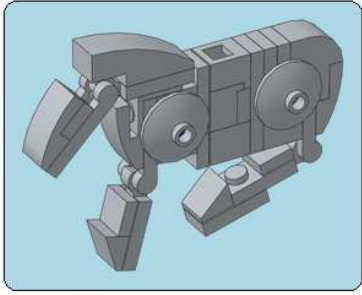

1

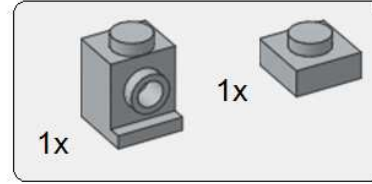
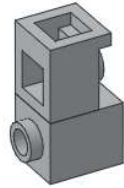

2

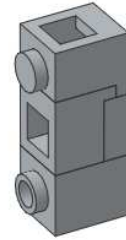

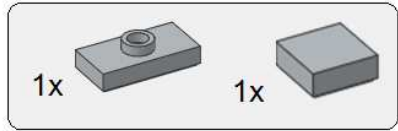

3

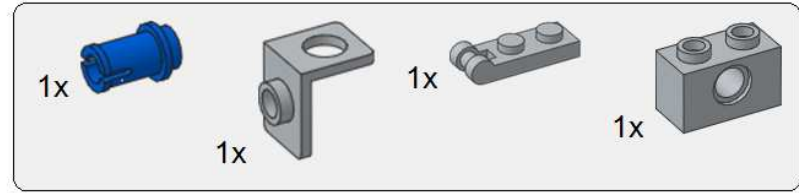
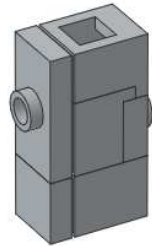

4

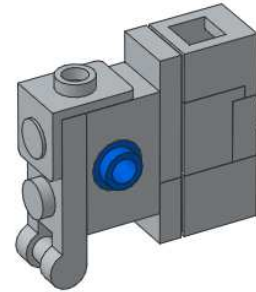

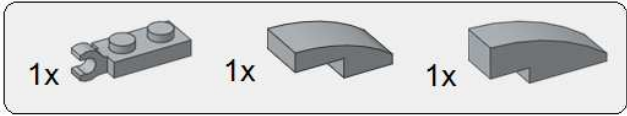

5

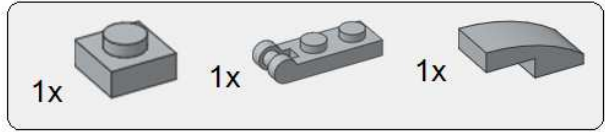
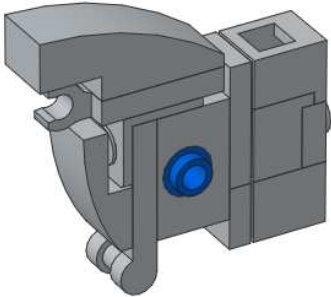

6

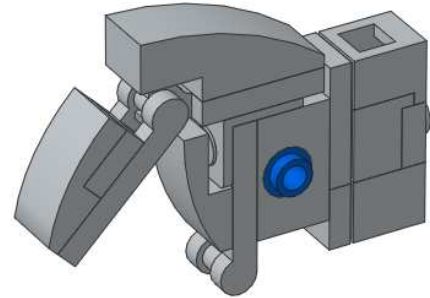

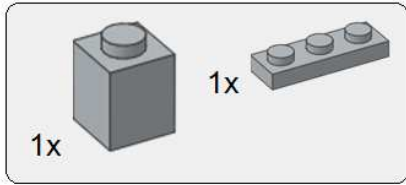

7

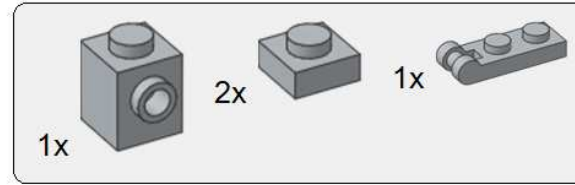
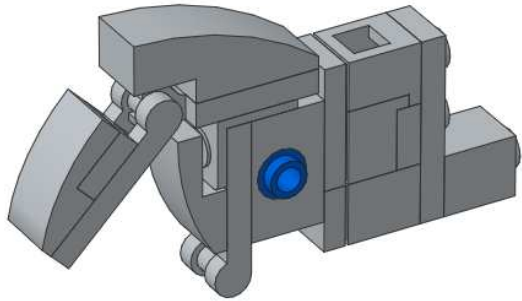

8

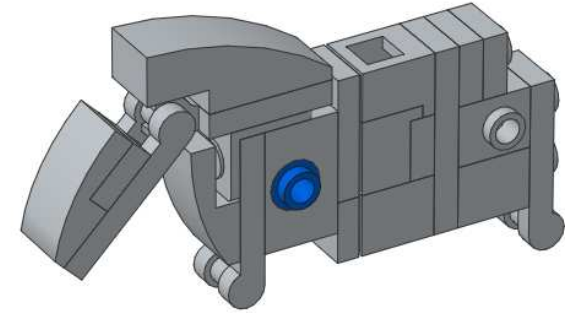

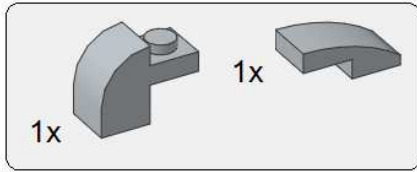

9

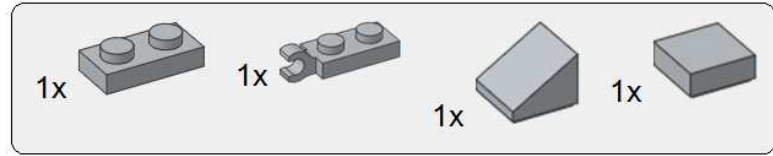
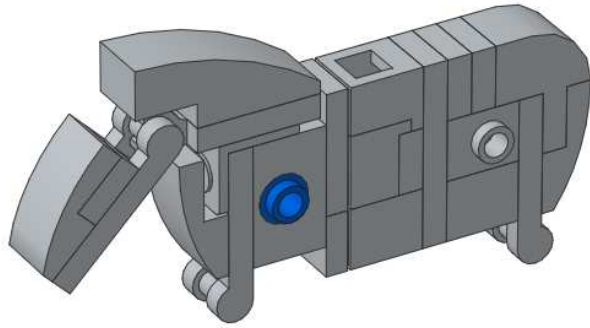

10

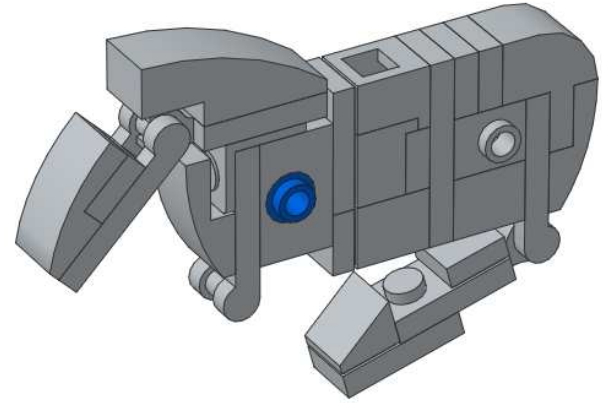

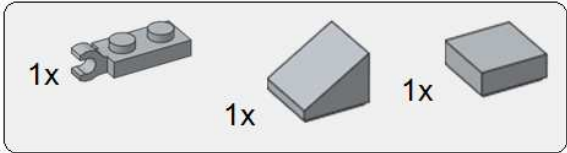

11

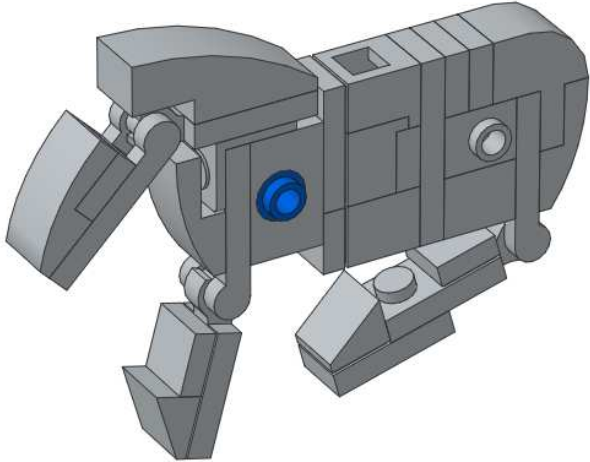

12

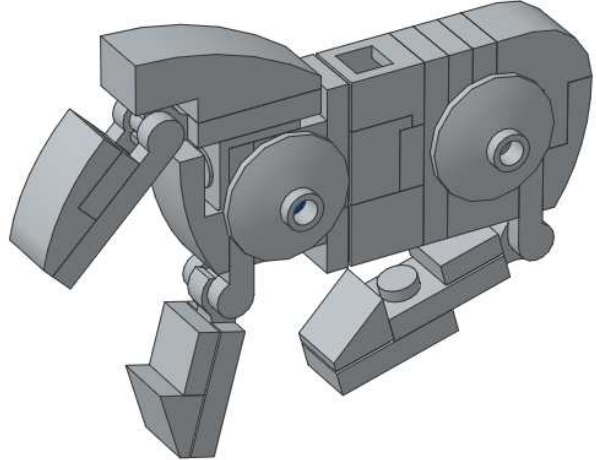

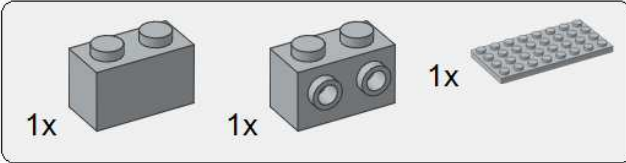
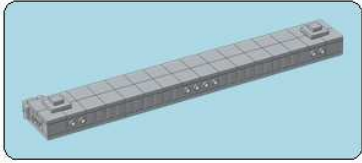

1

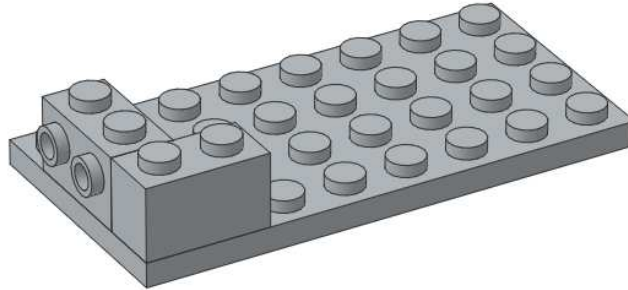

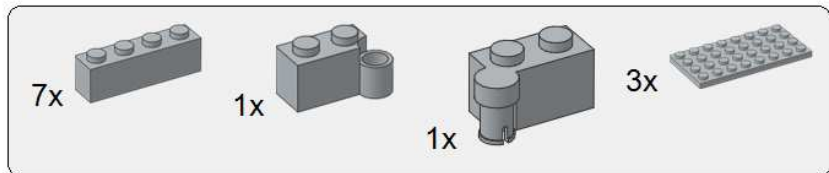

2

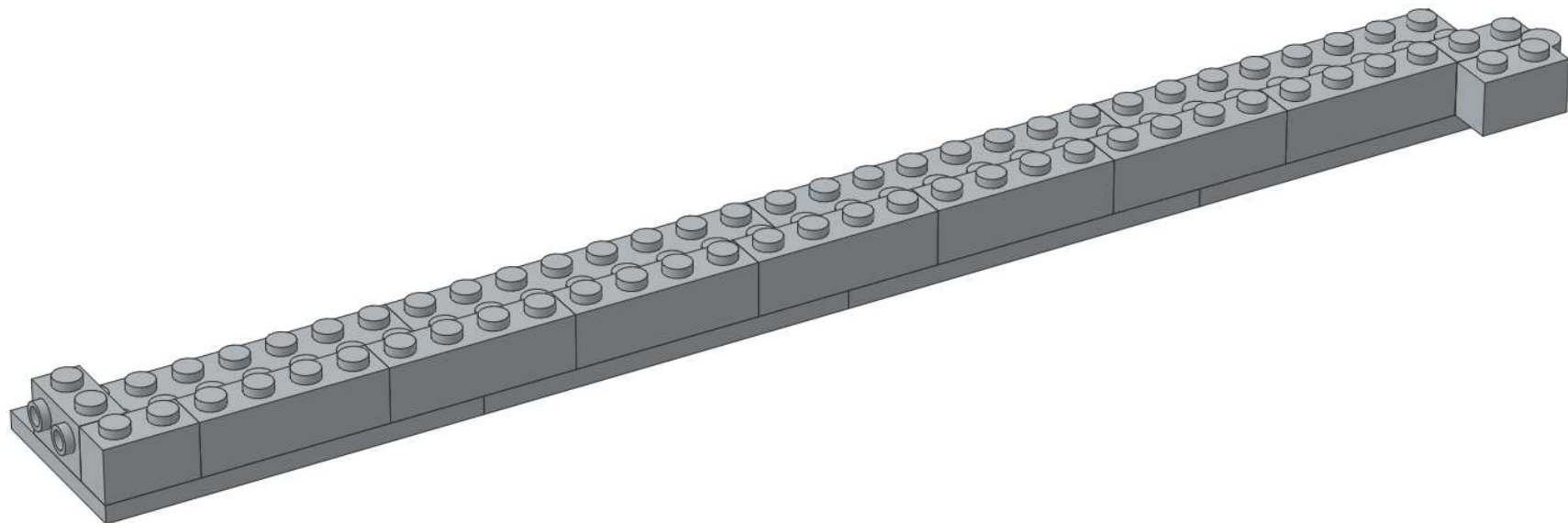

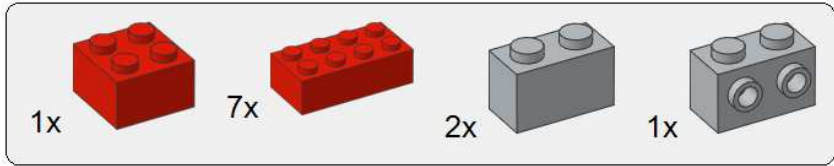

3

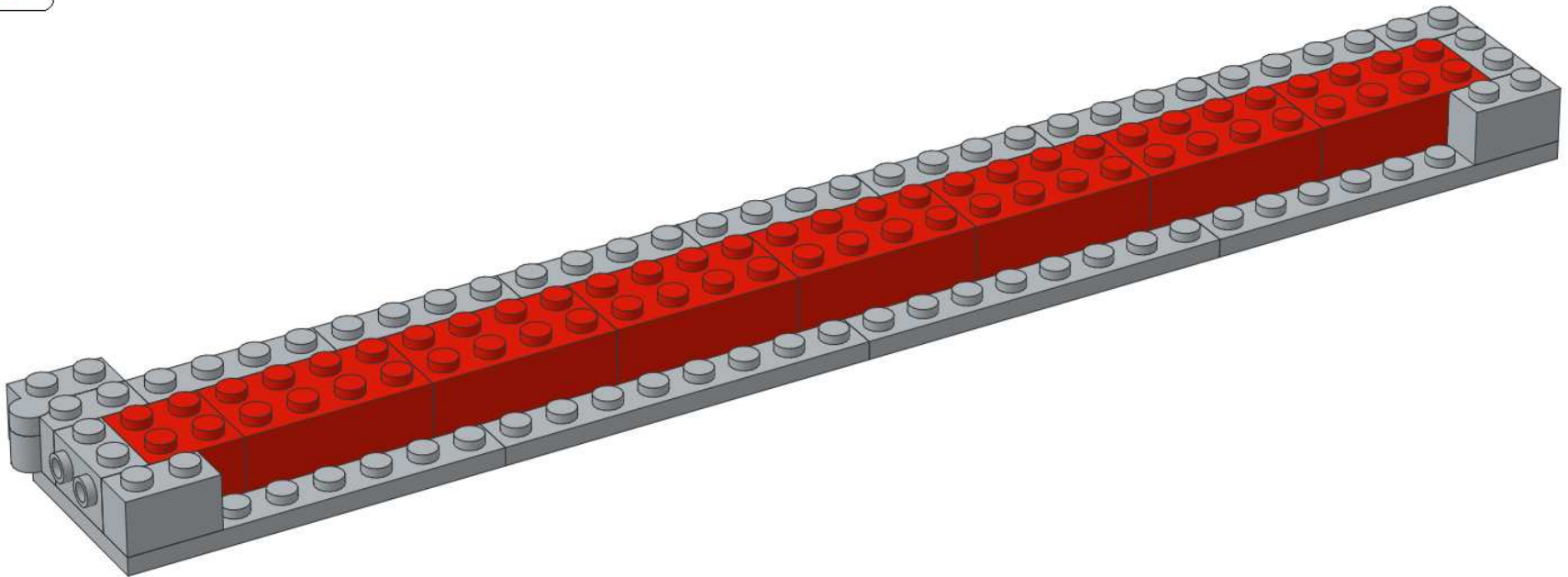

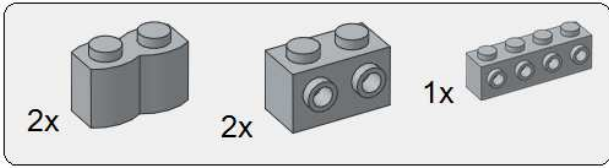

4

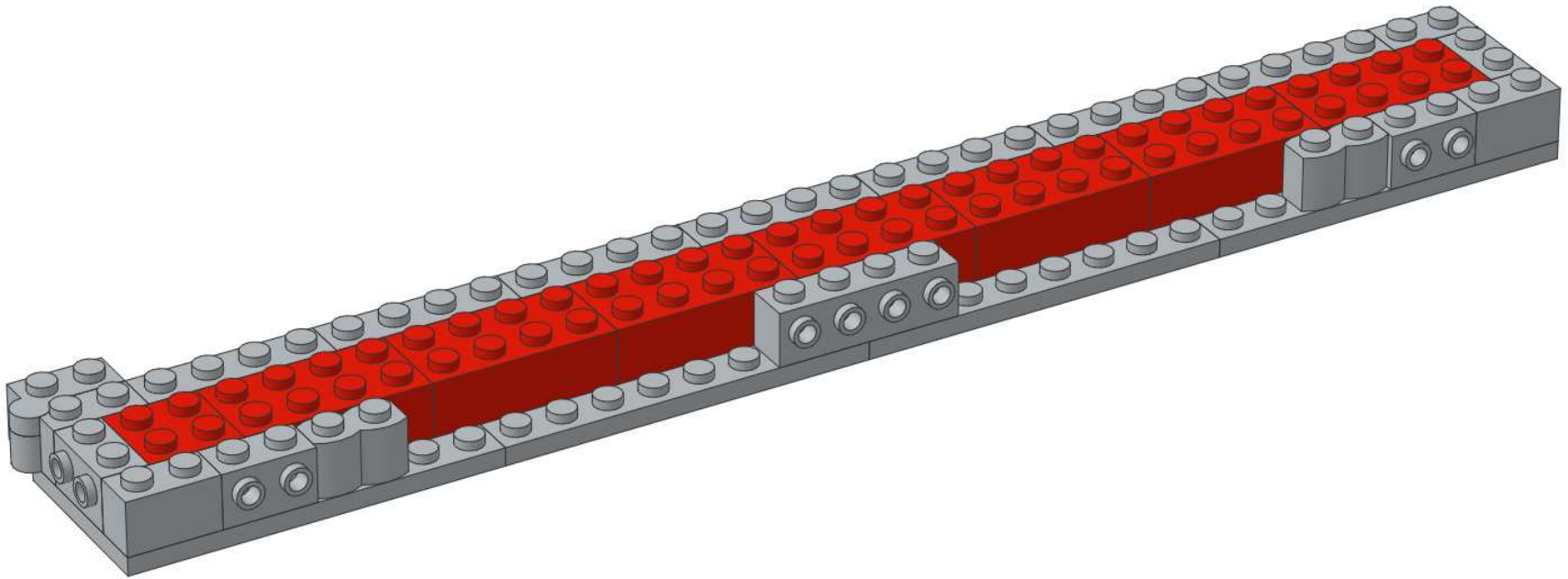

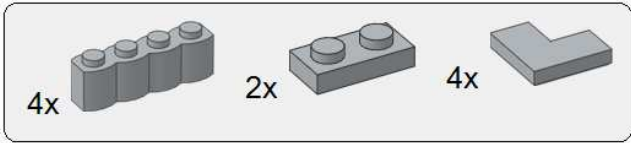

5

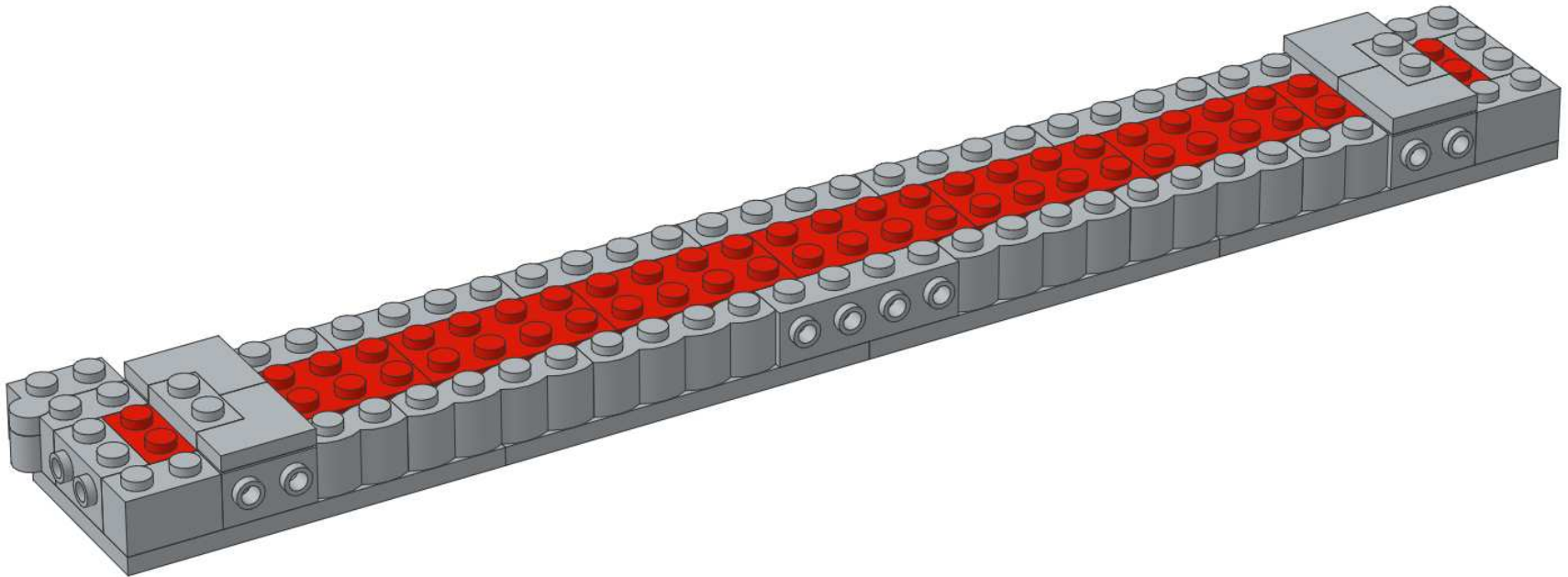

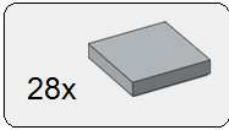

6

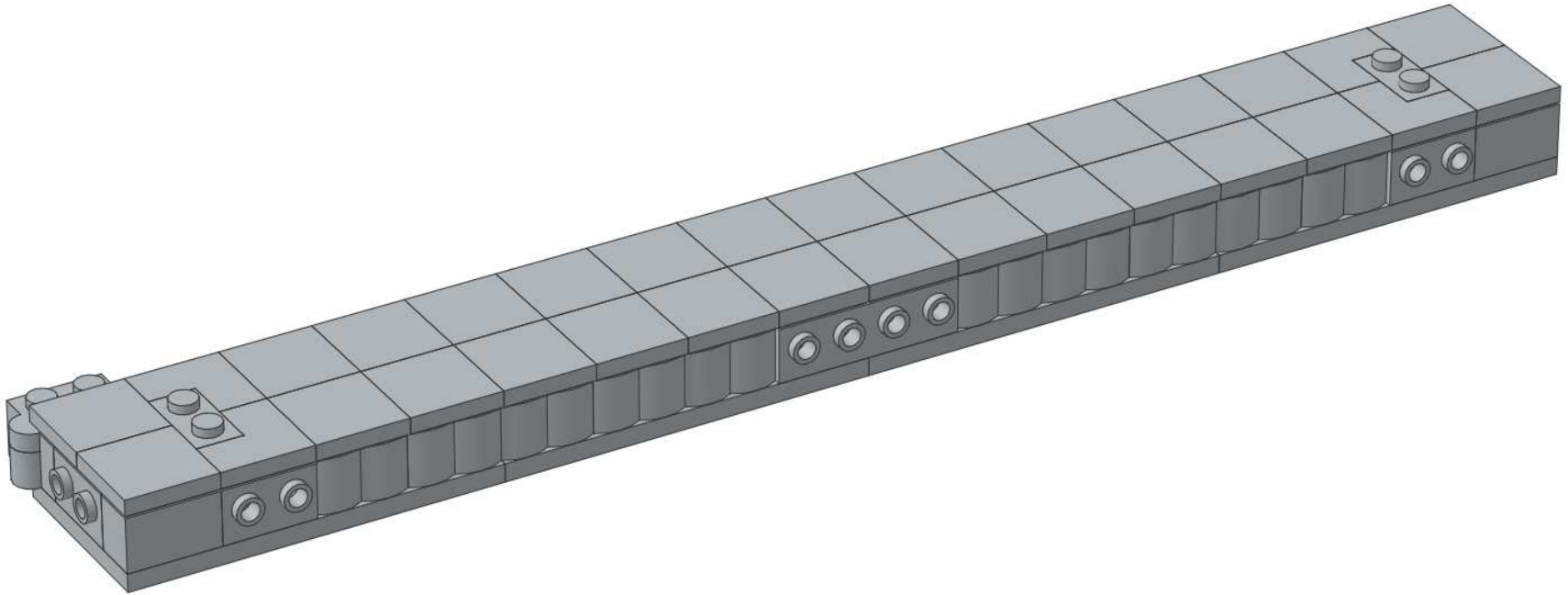

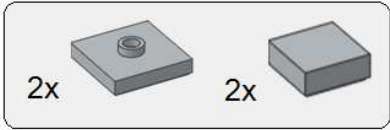

7

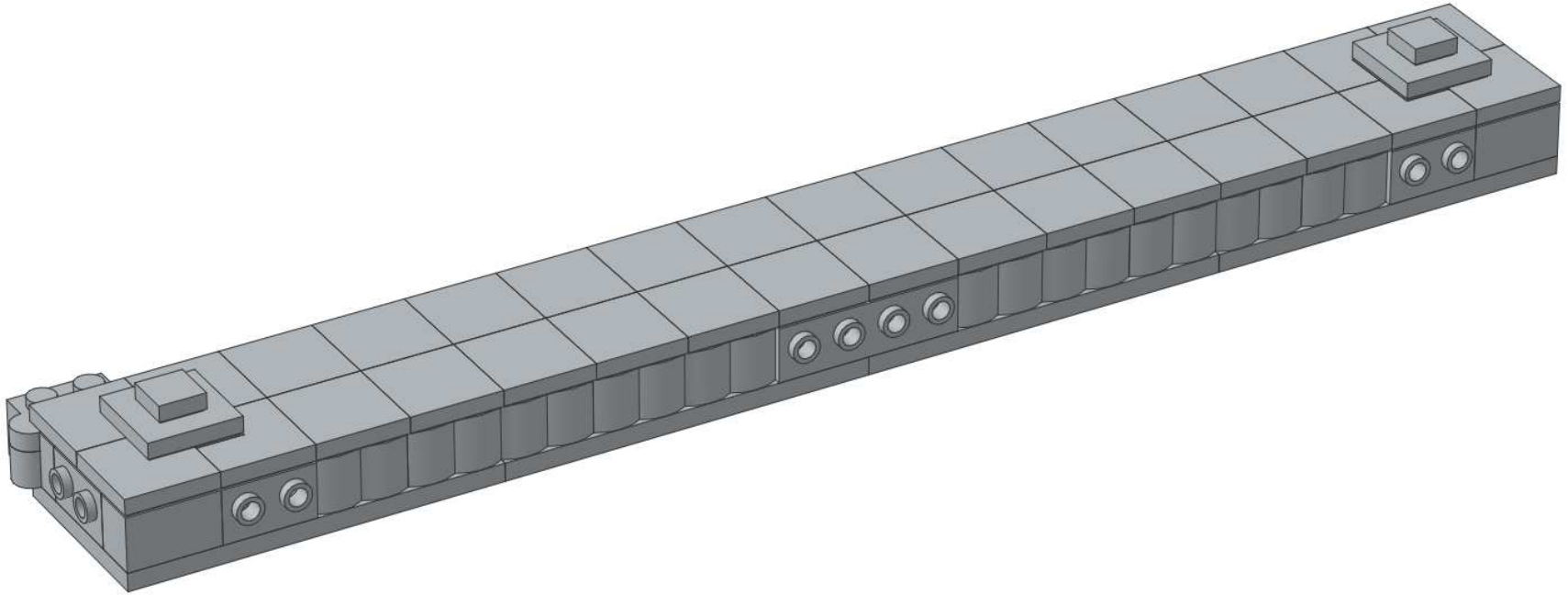



8

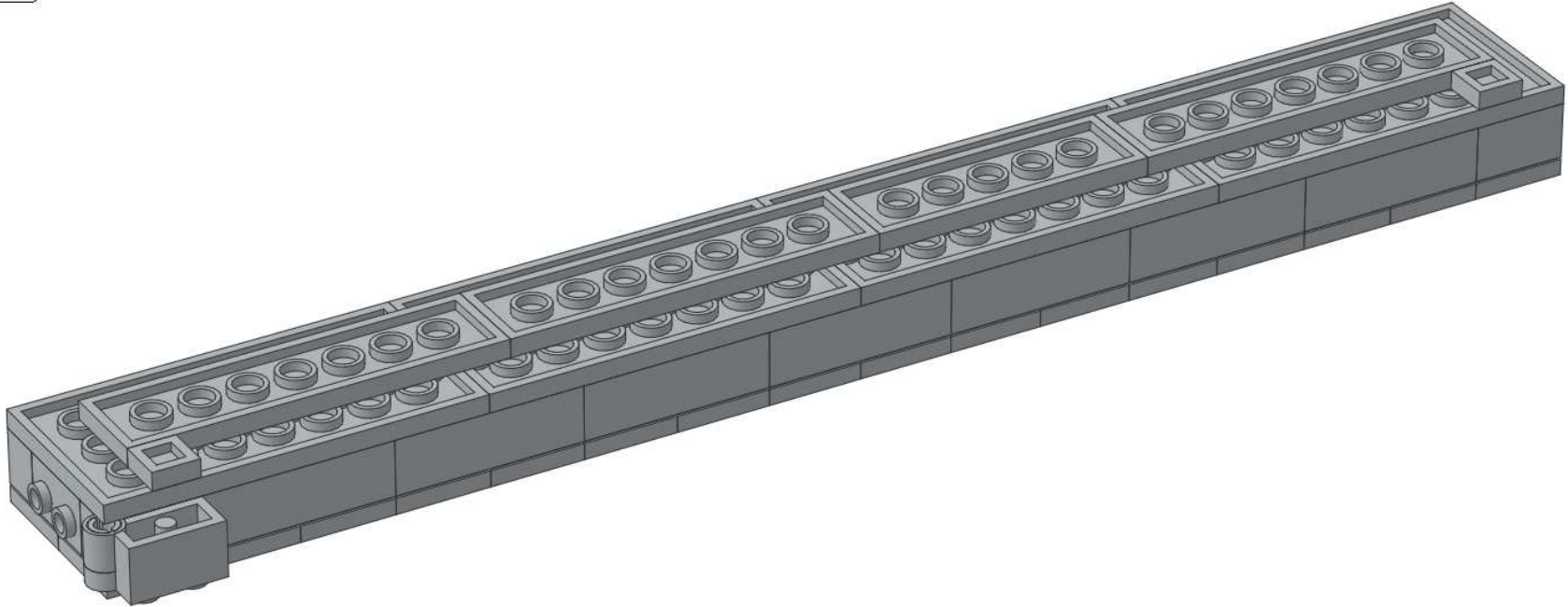

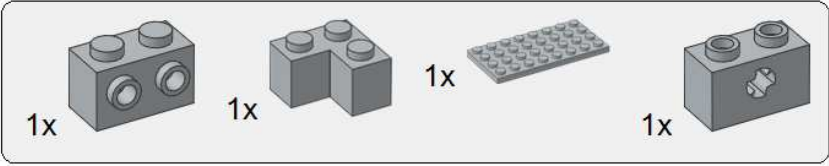
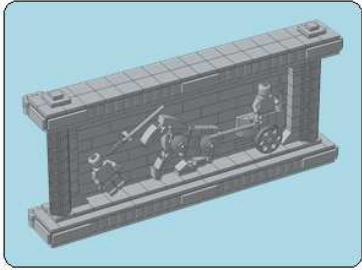

1

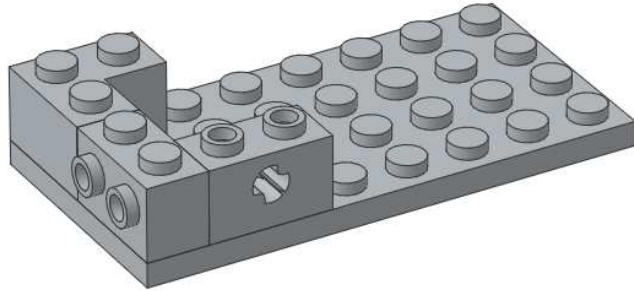

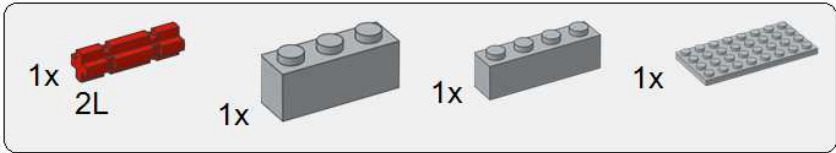

2

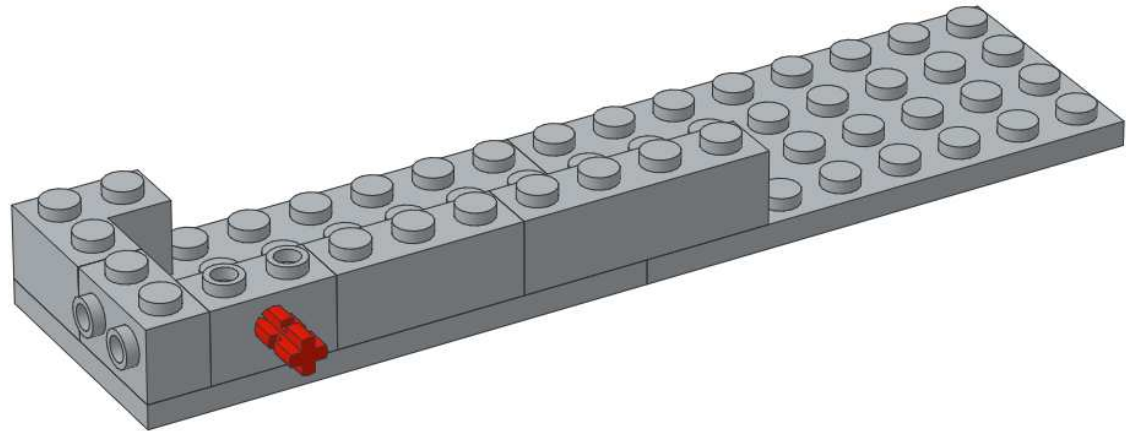

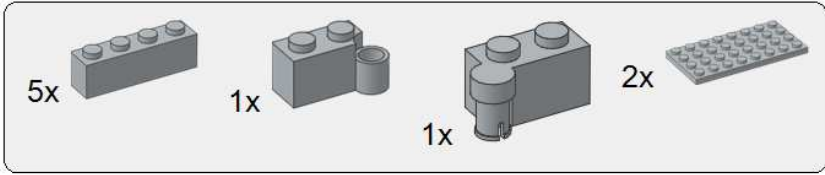

3

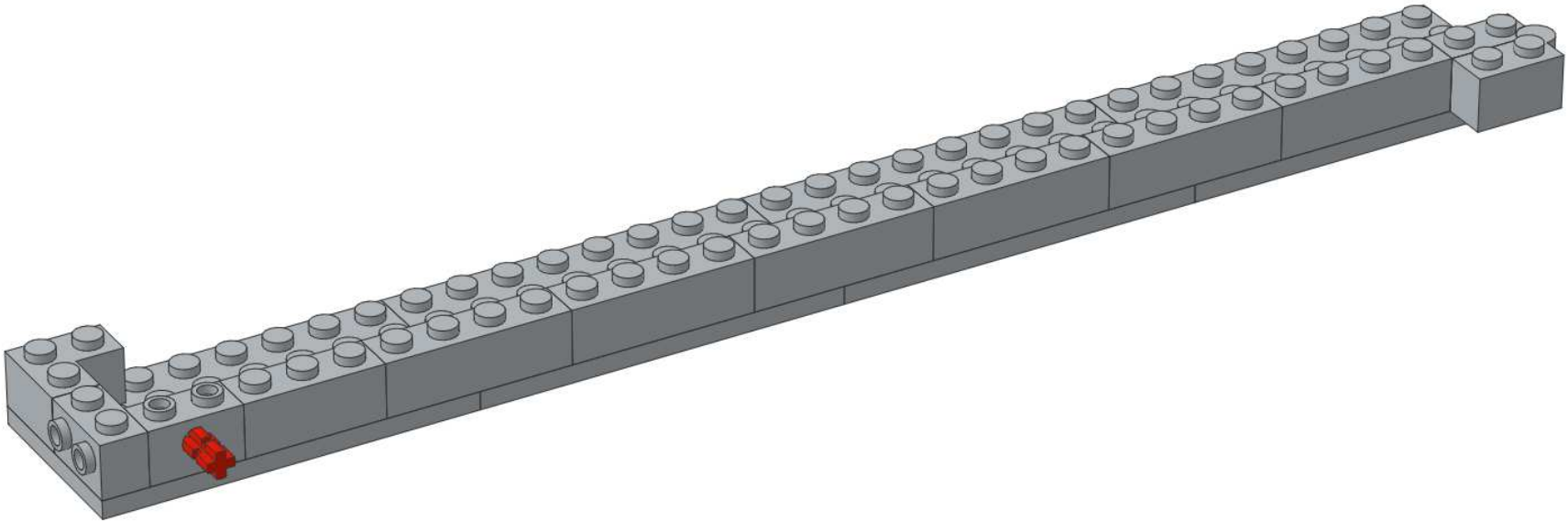

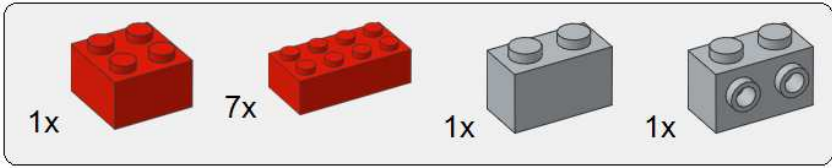

4

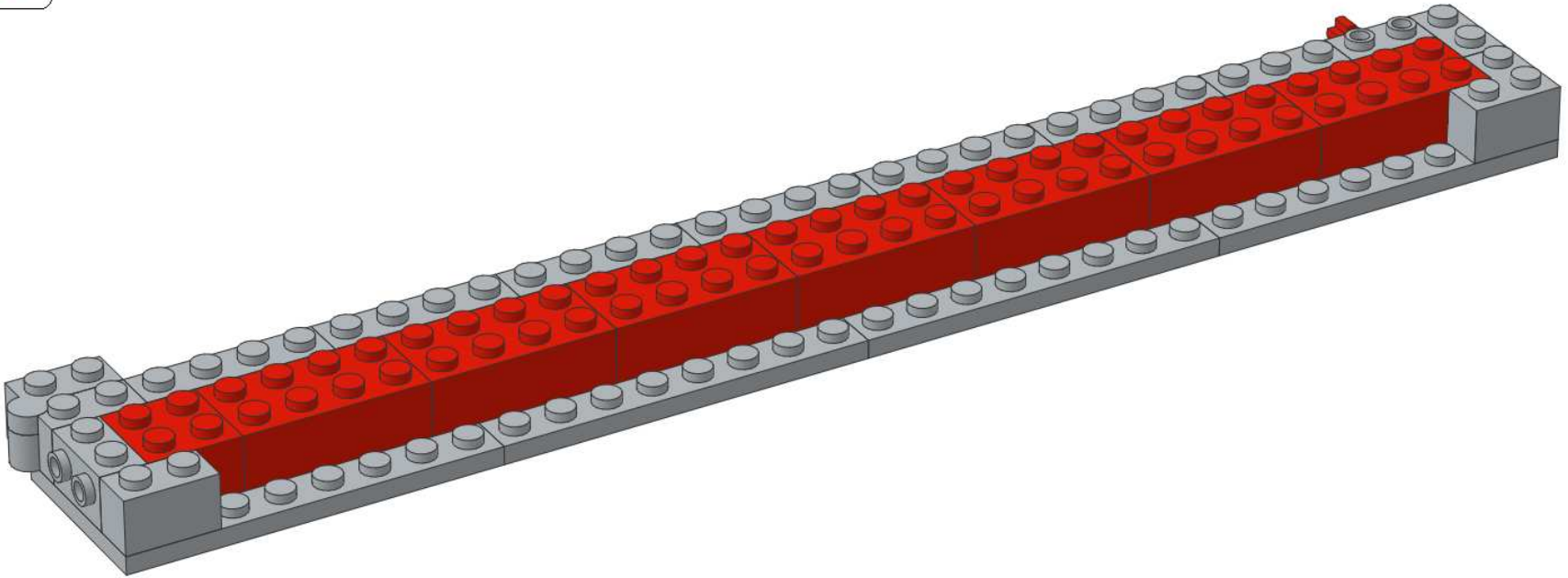

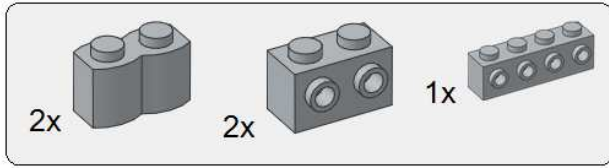

5

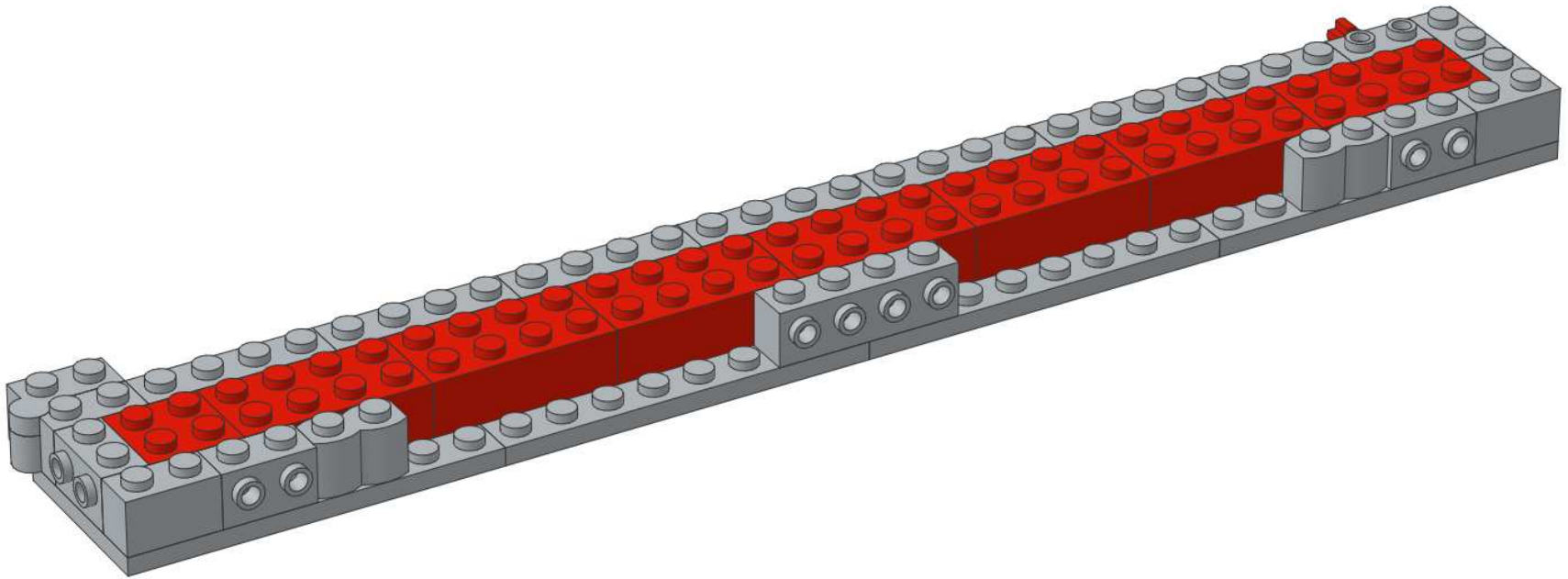

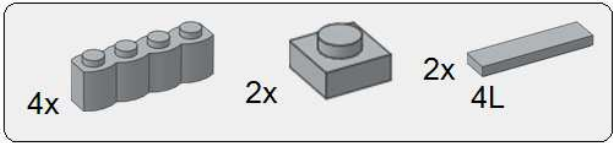

6

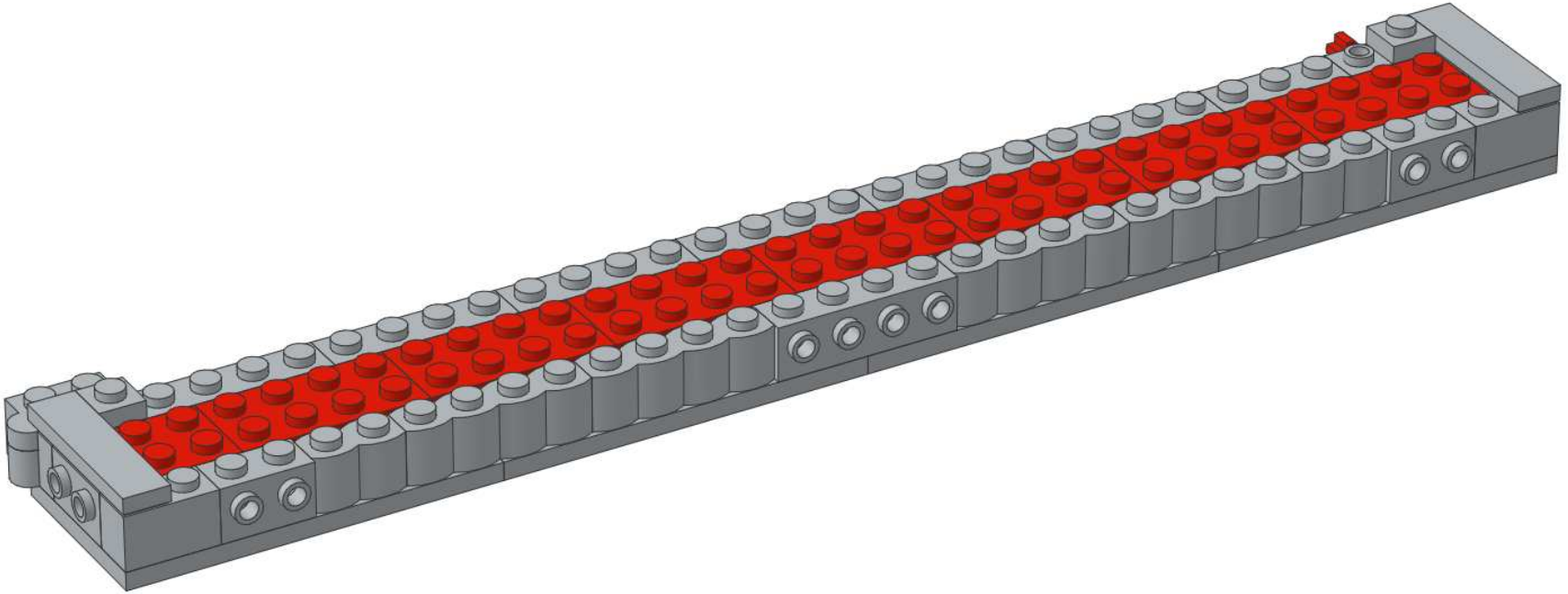



7

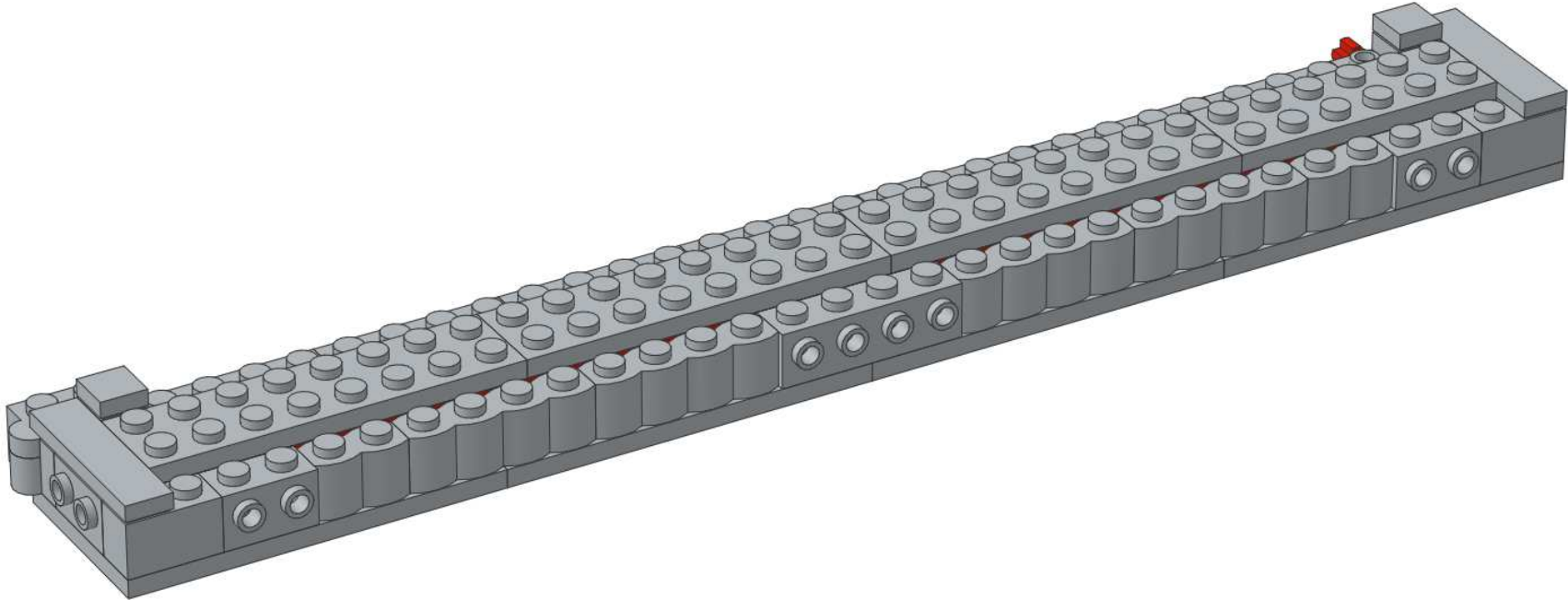

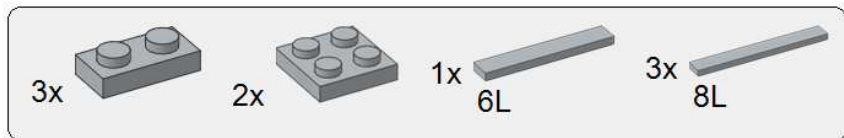

8

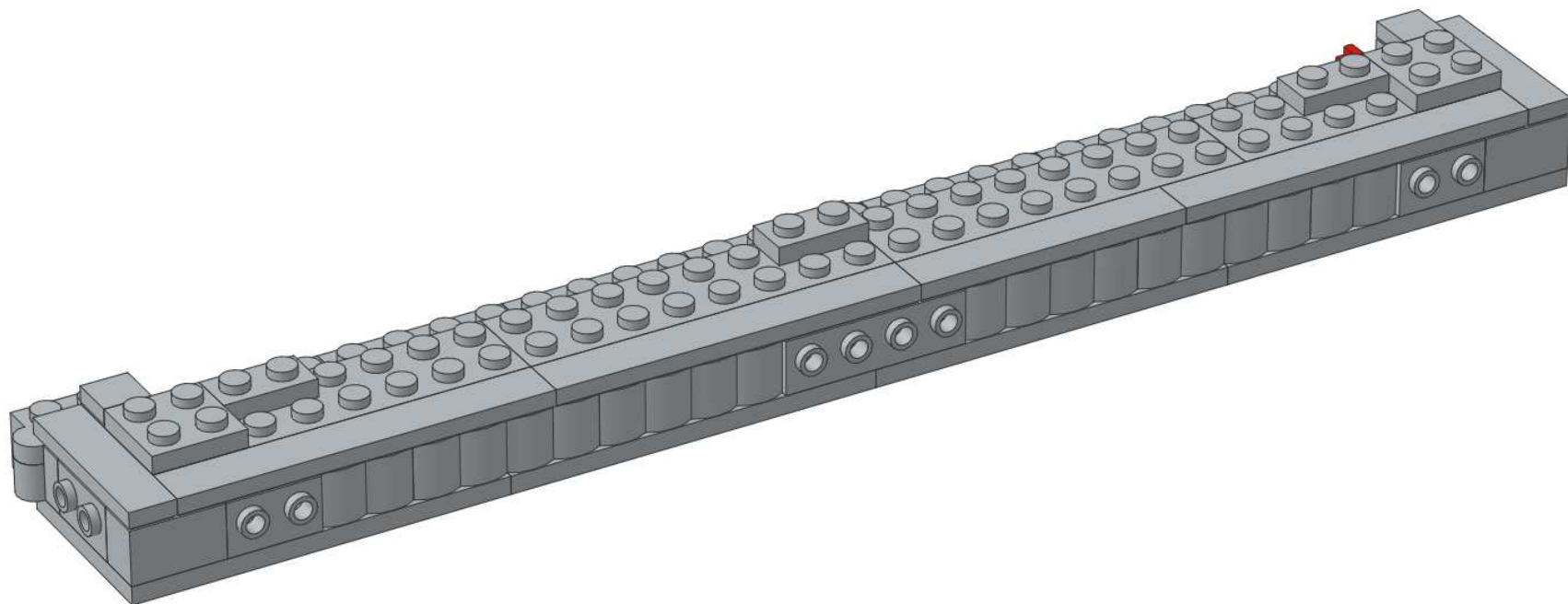

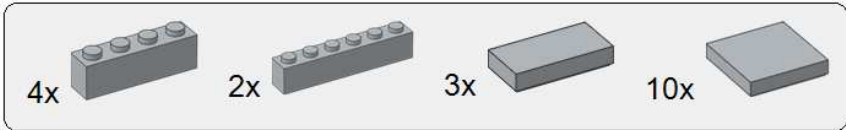

9

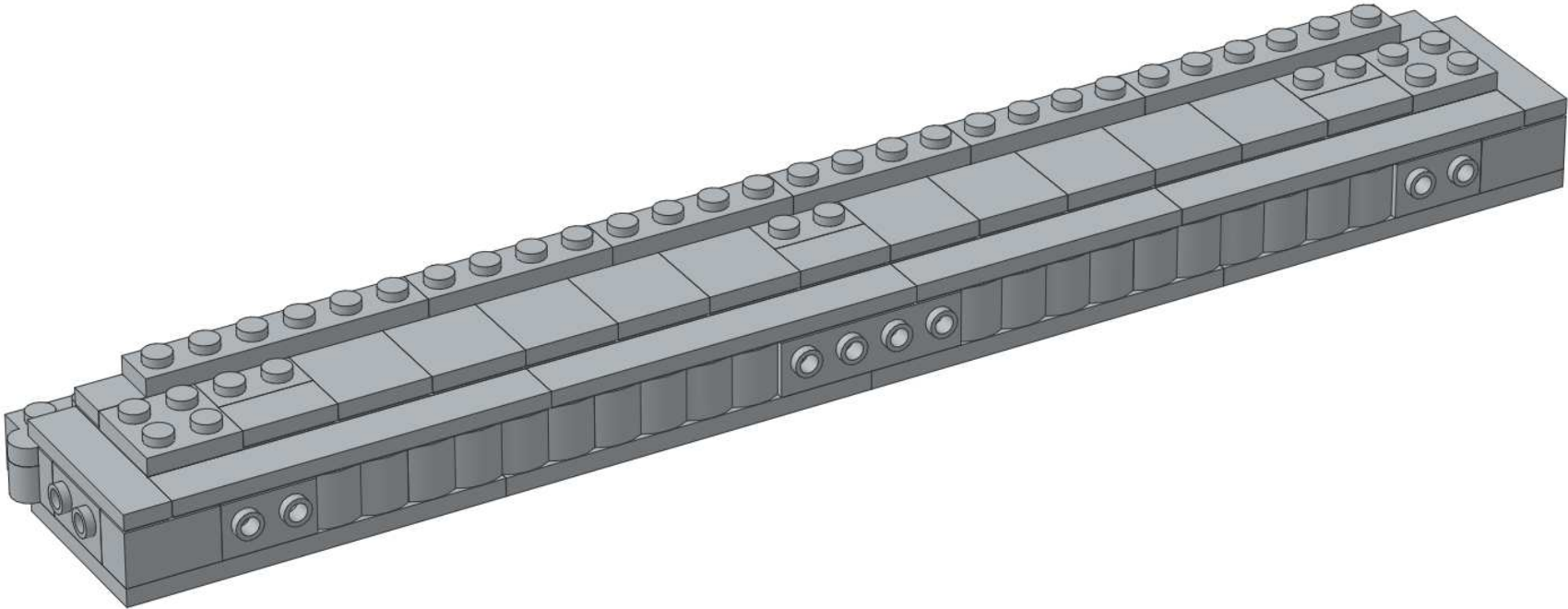

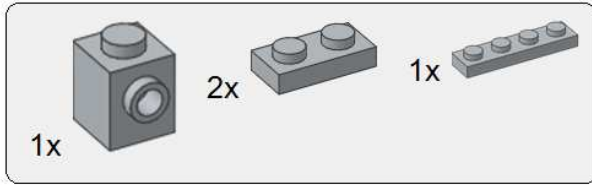

10

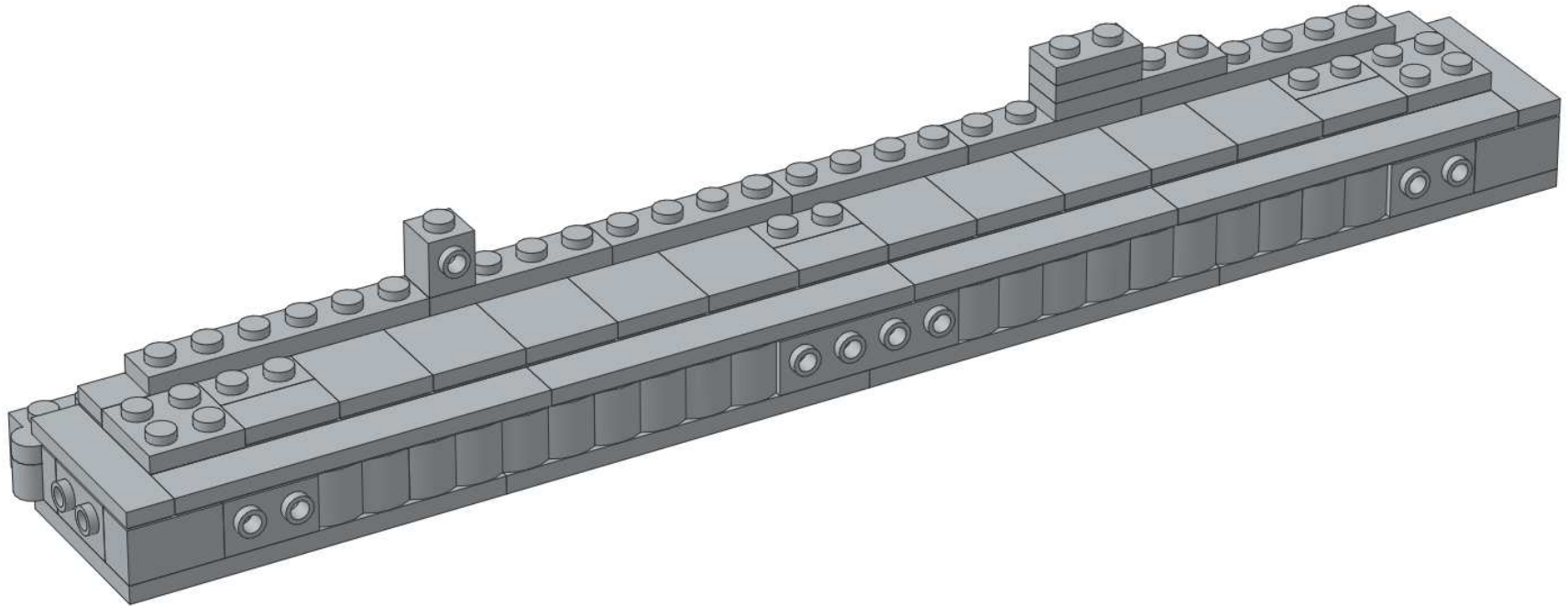

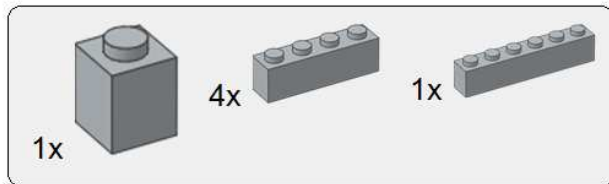

11

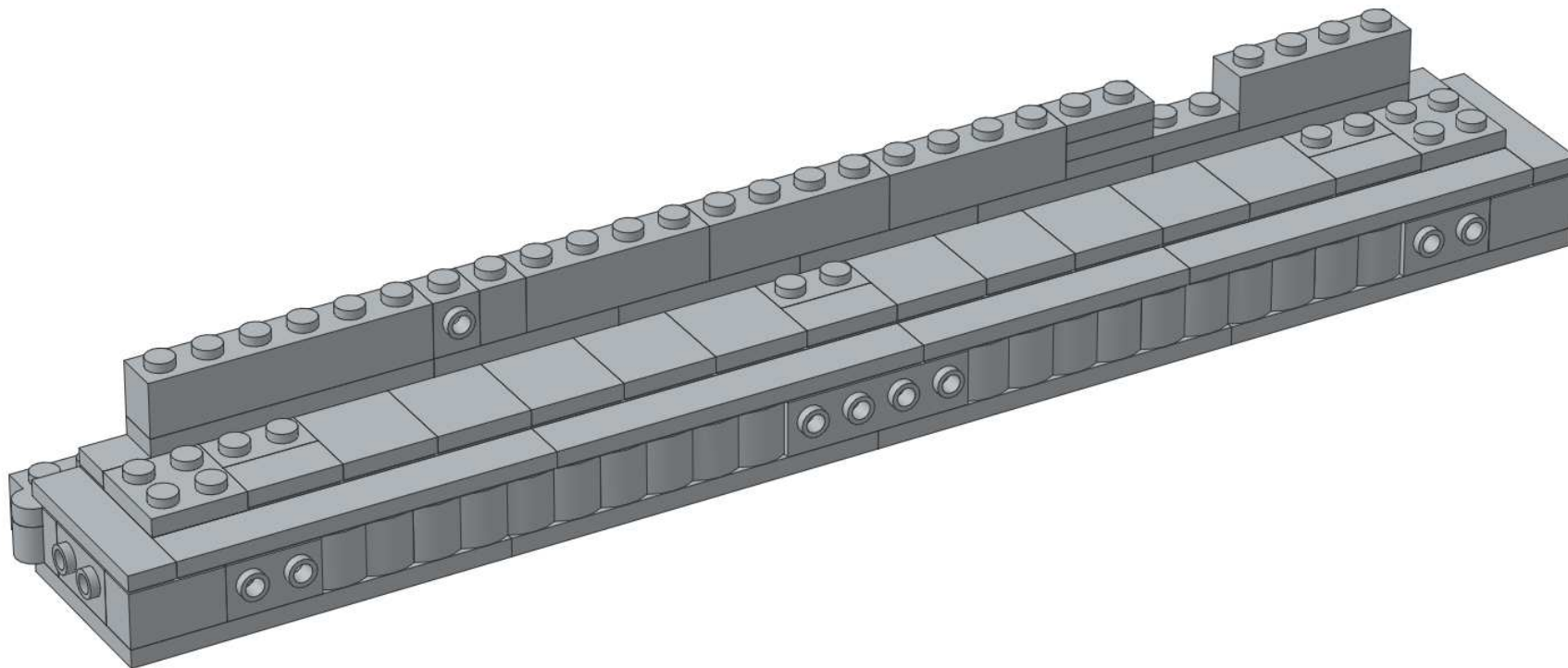

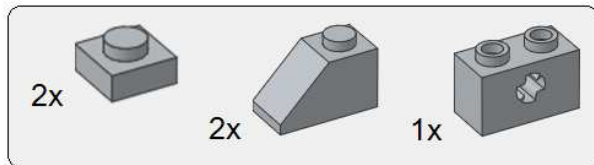

12

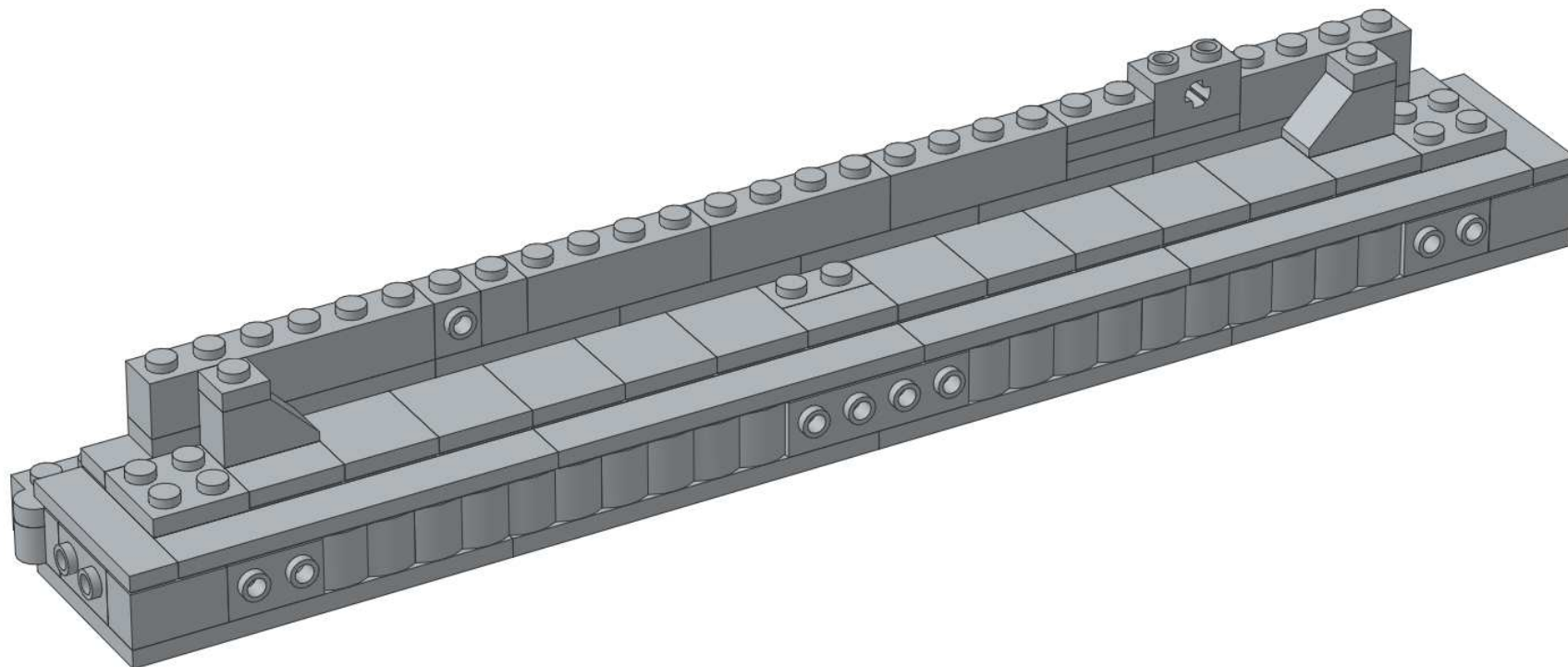

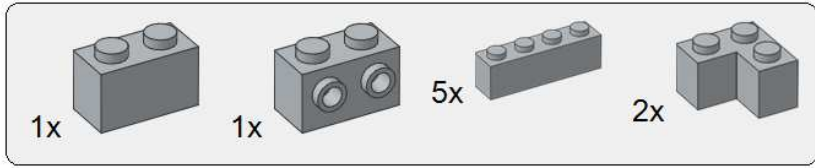

13

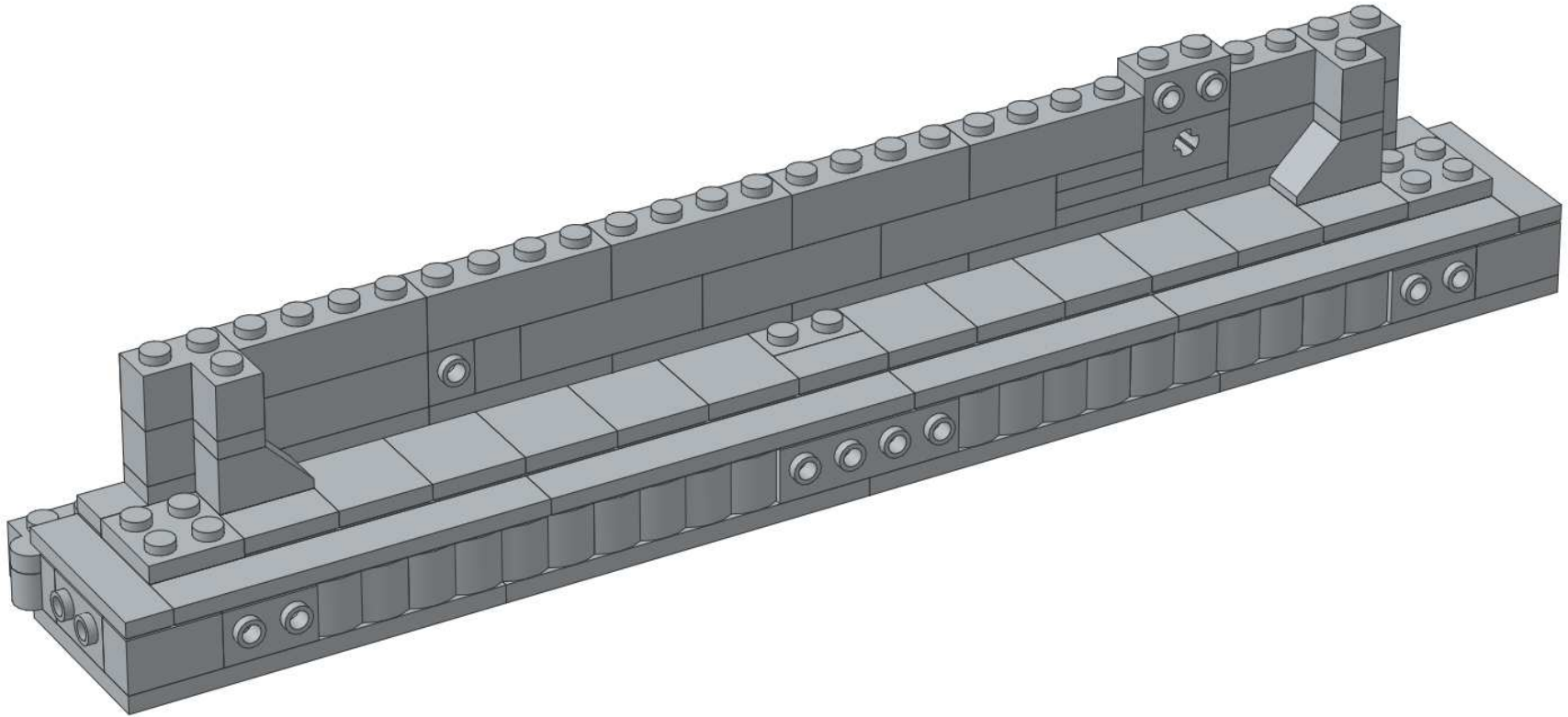

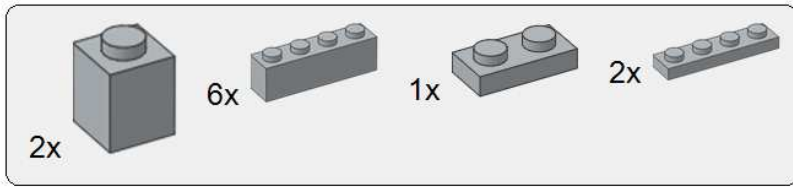

14

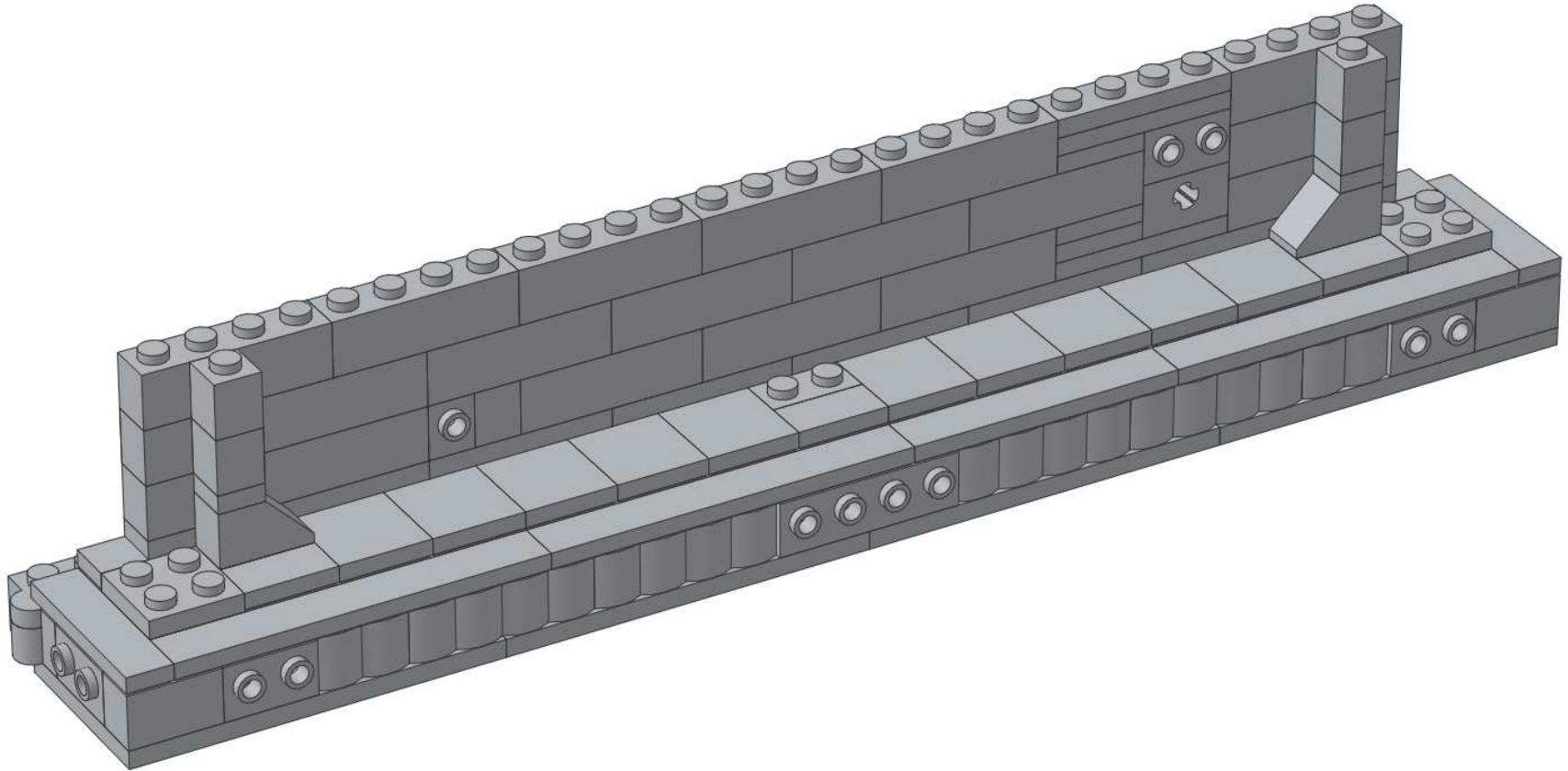

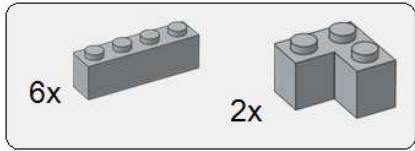

15

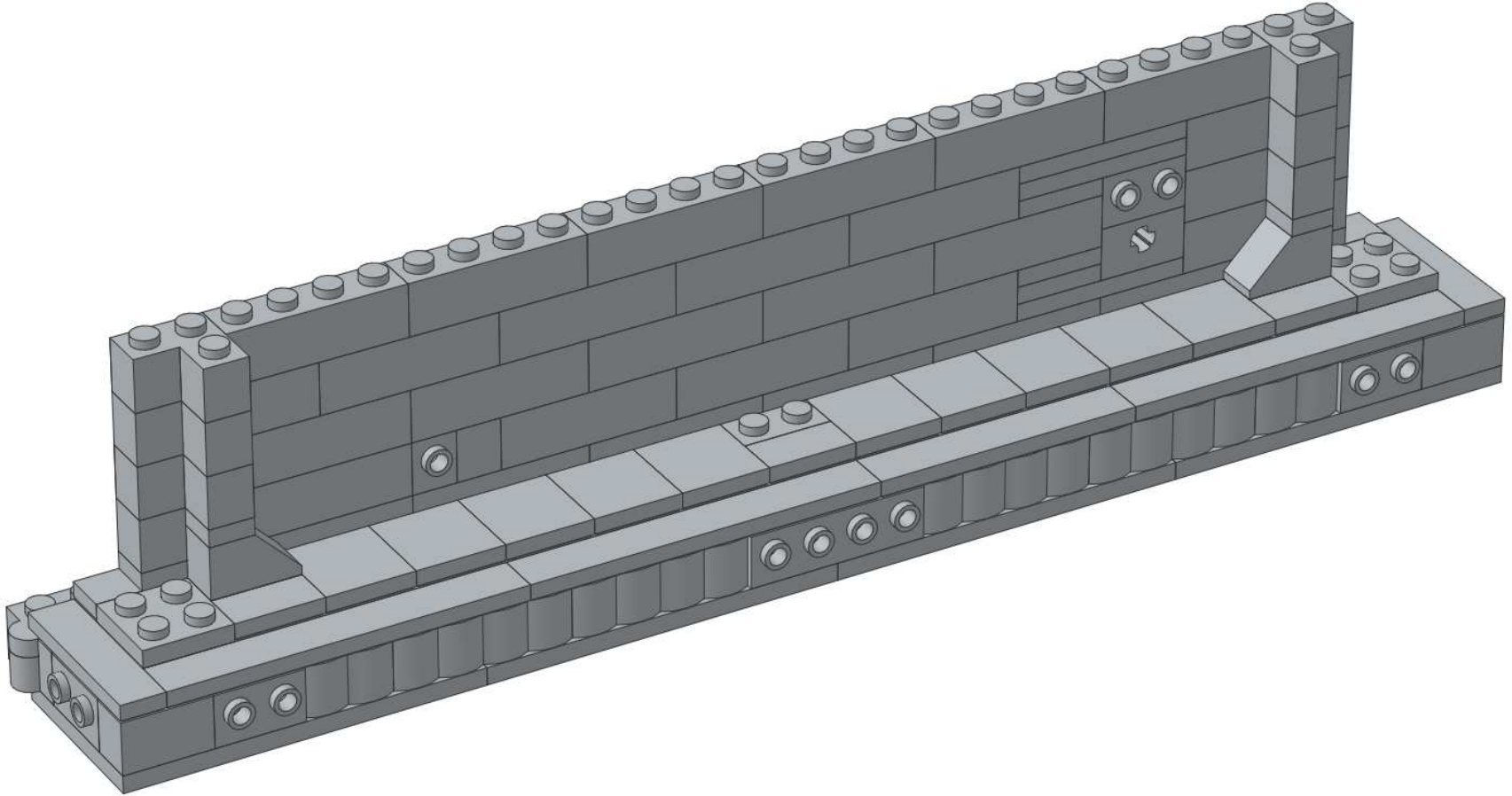

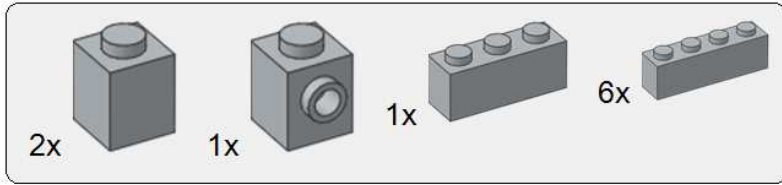

16

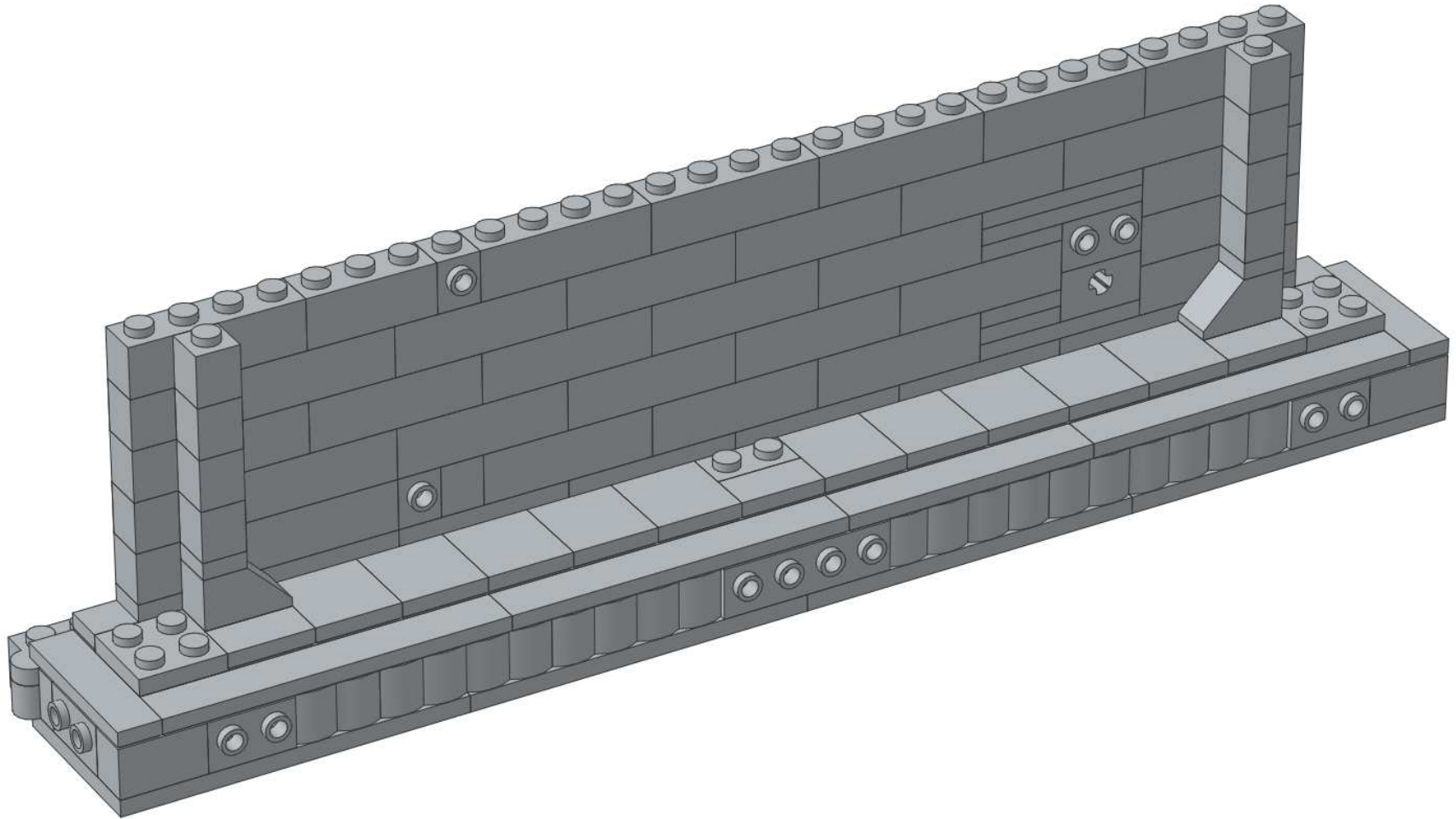

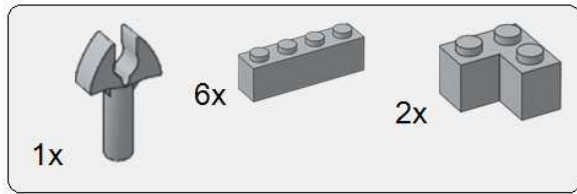

17

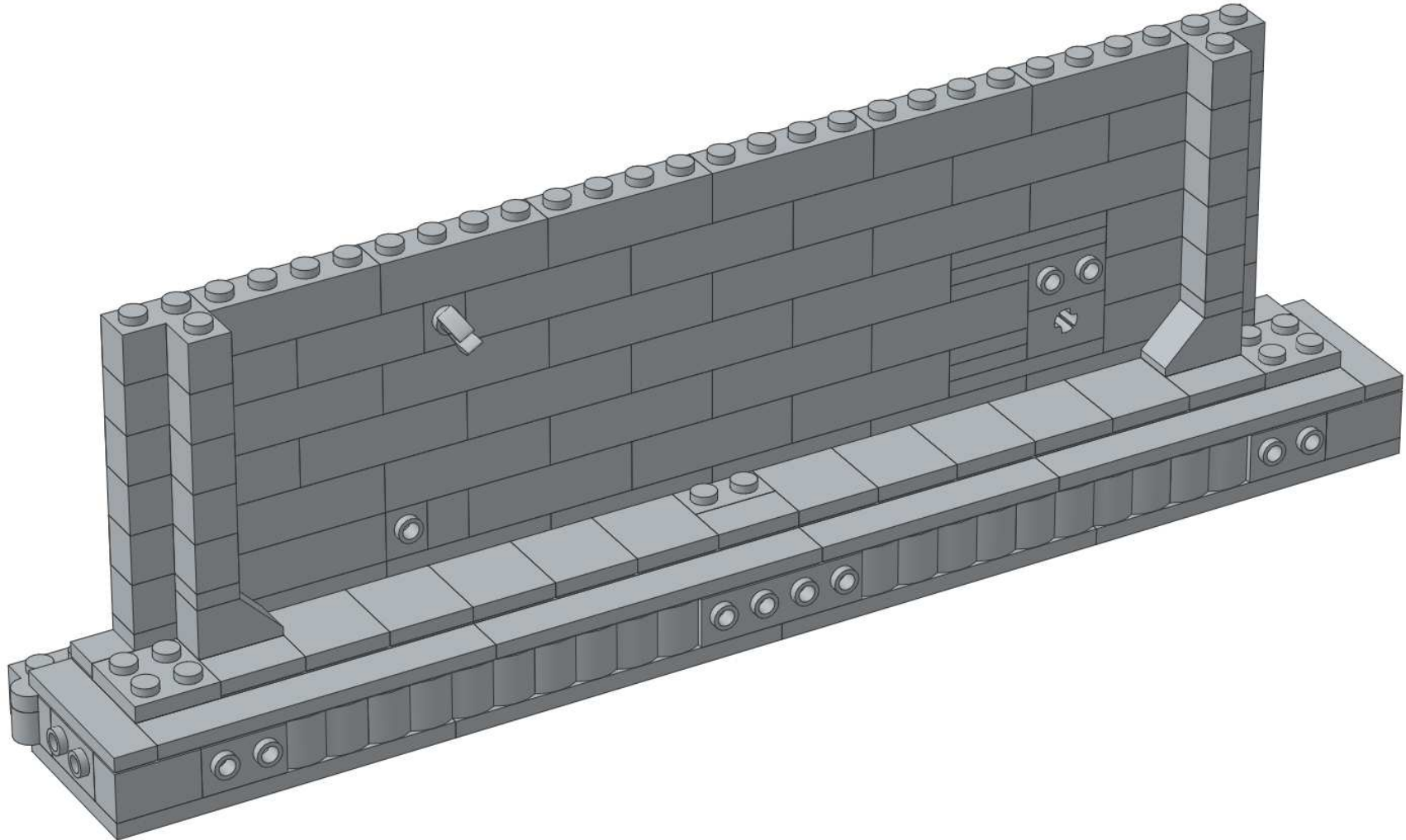

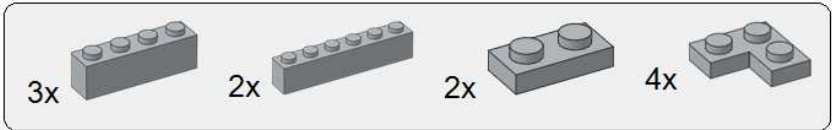

18

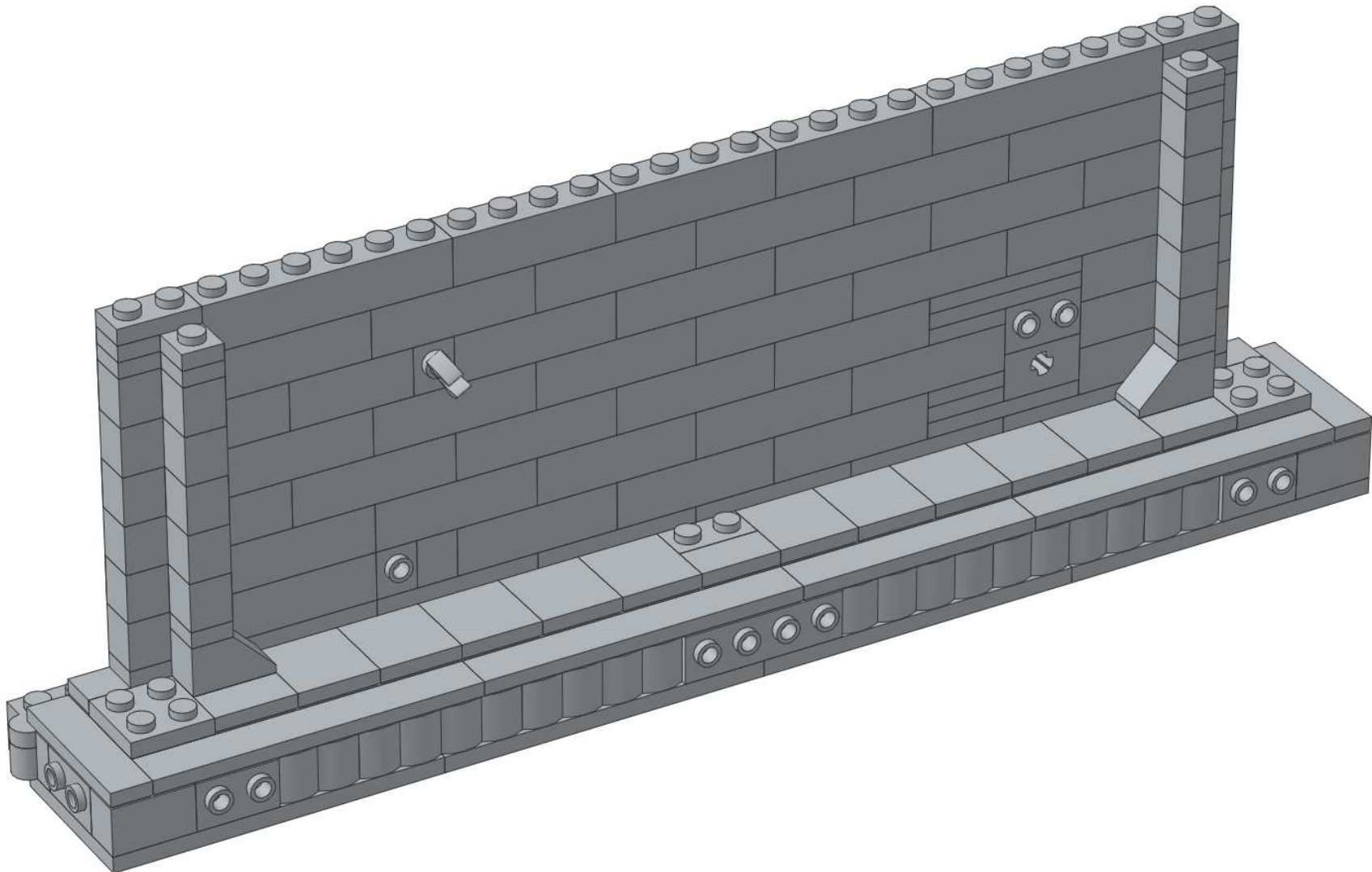

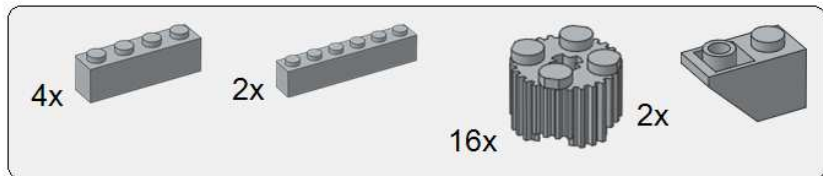

19

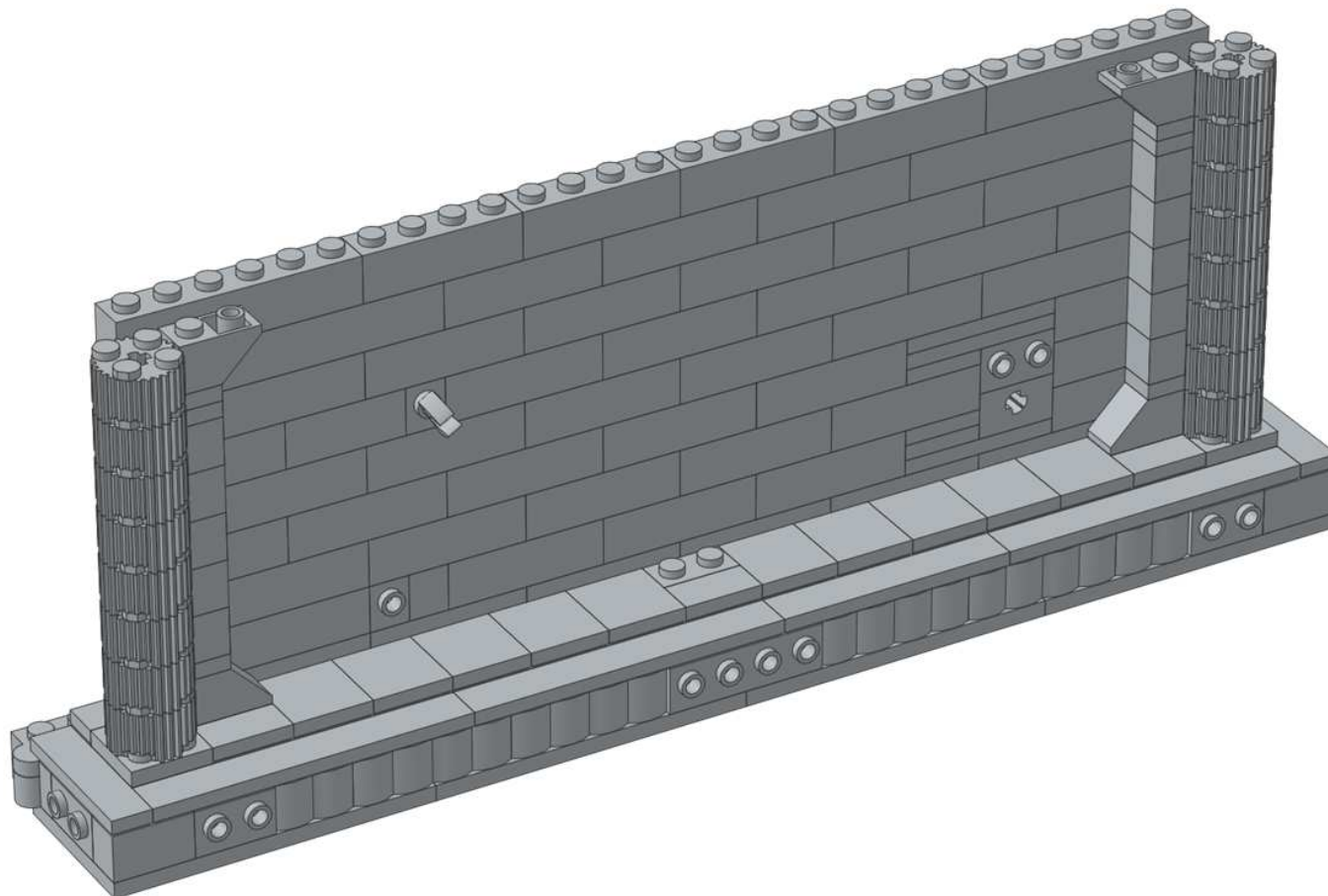



20

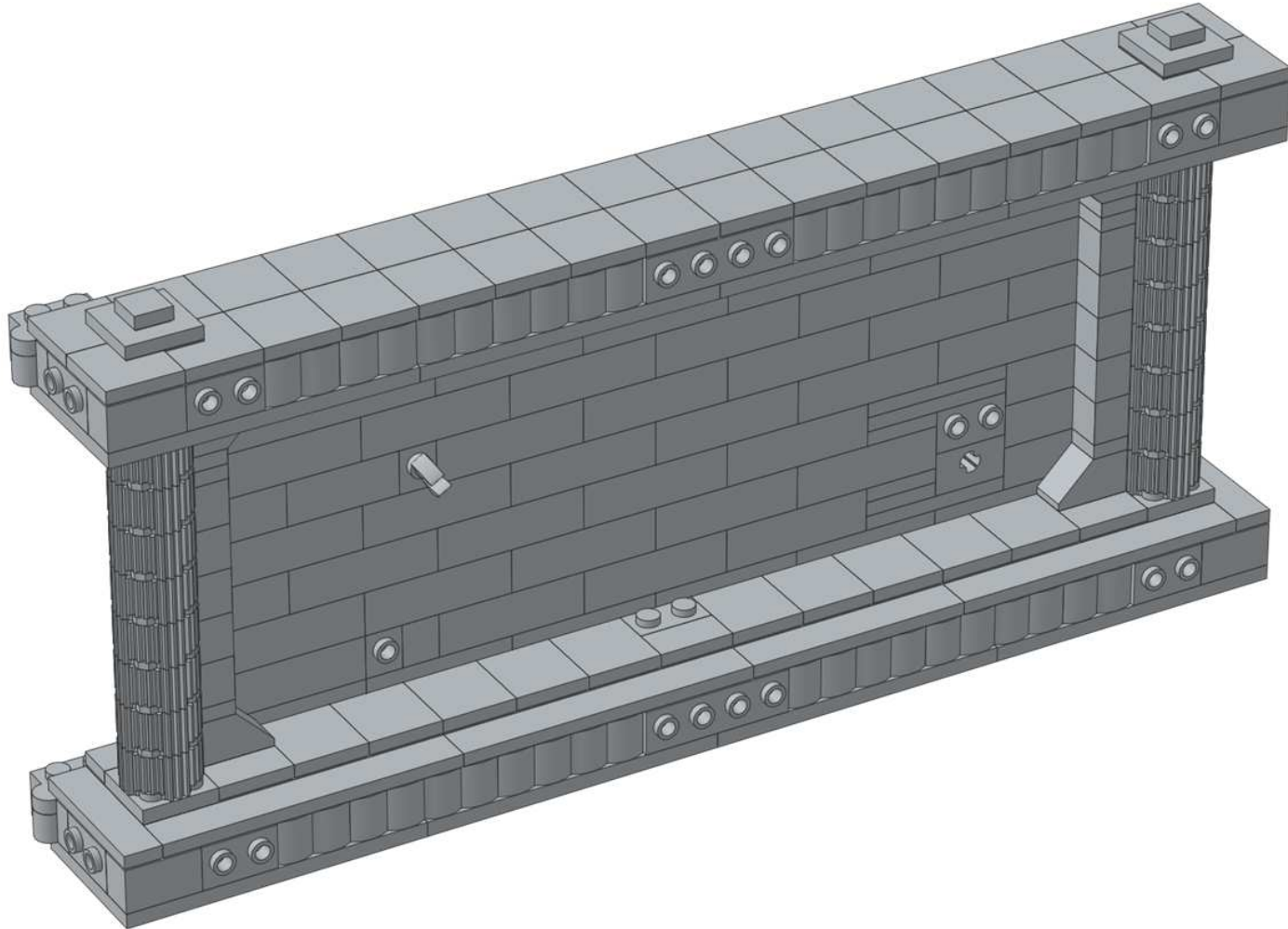

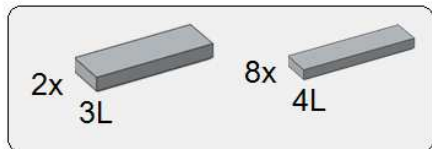

21

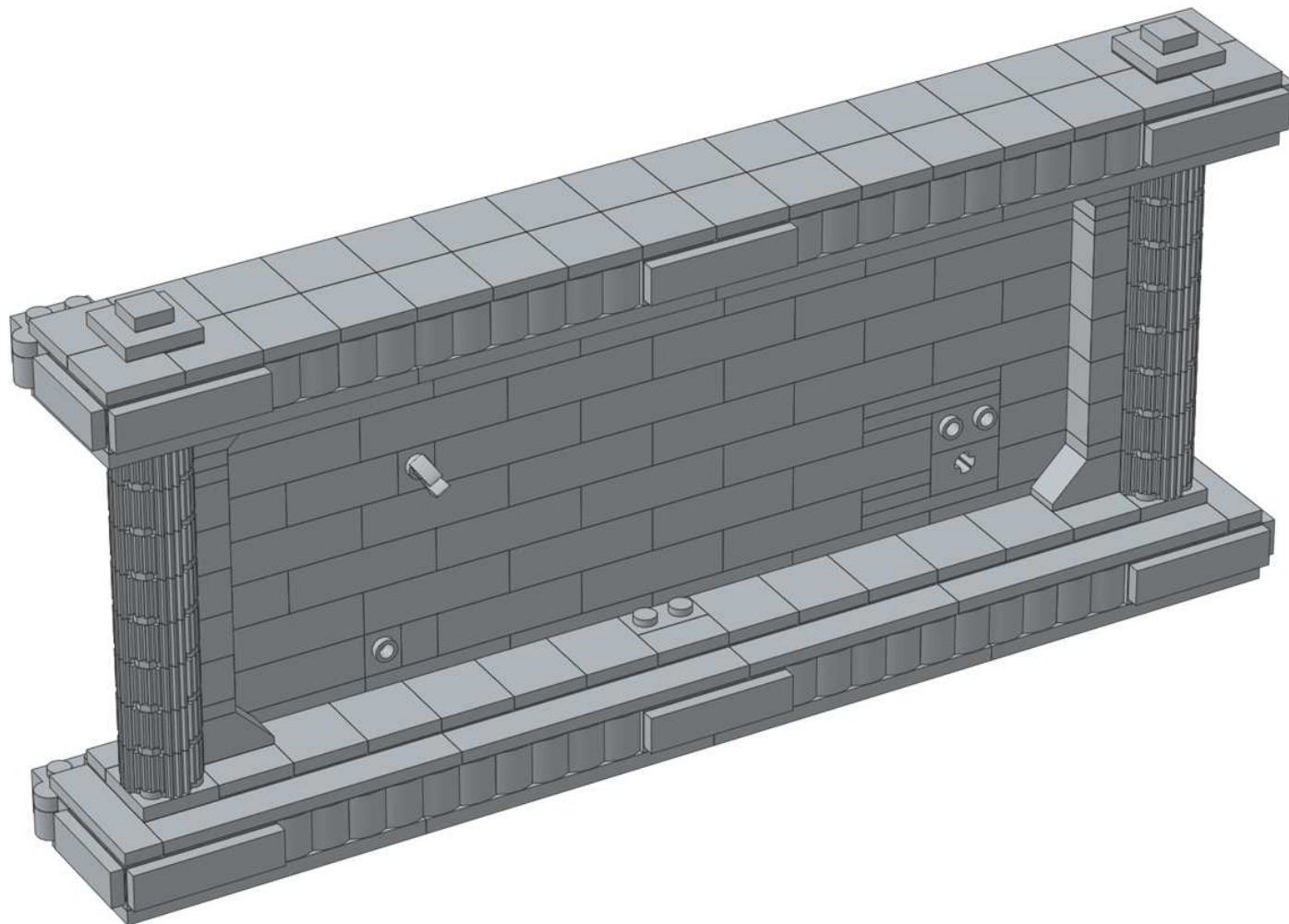

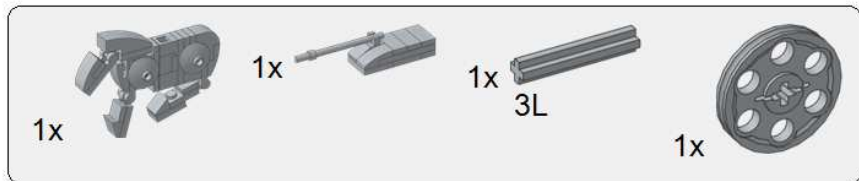

22

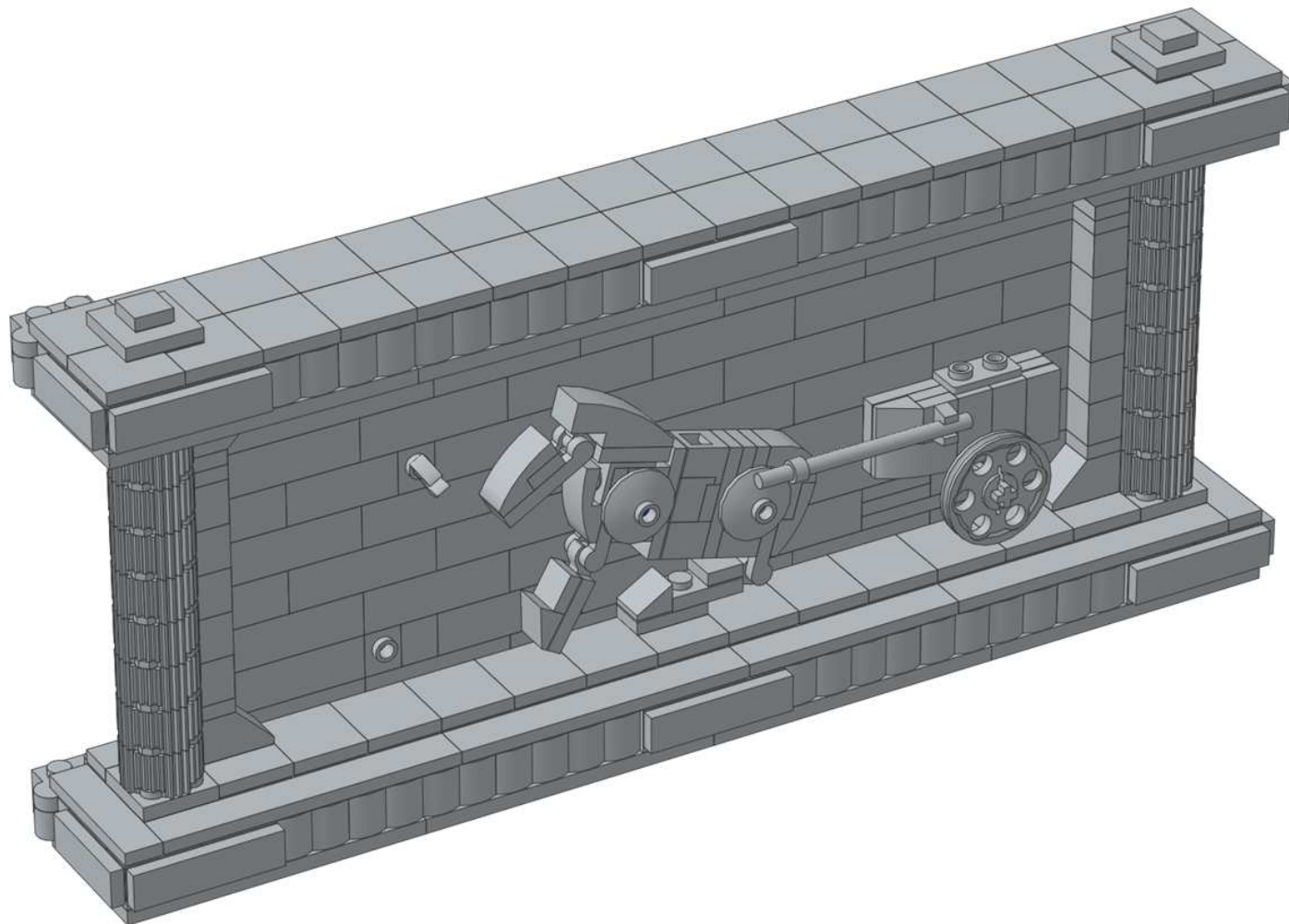

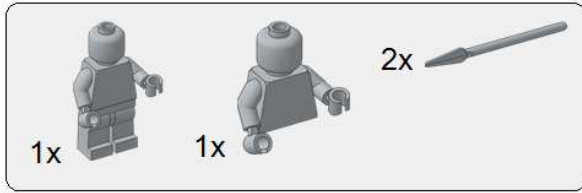

23

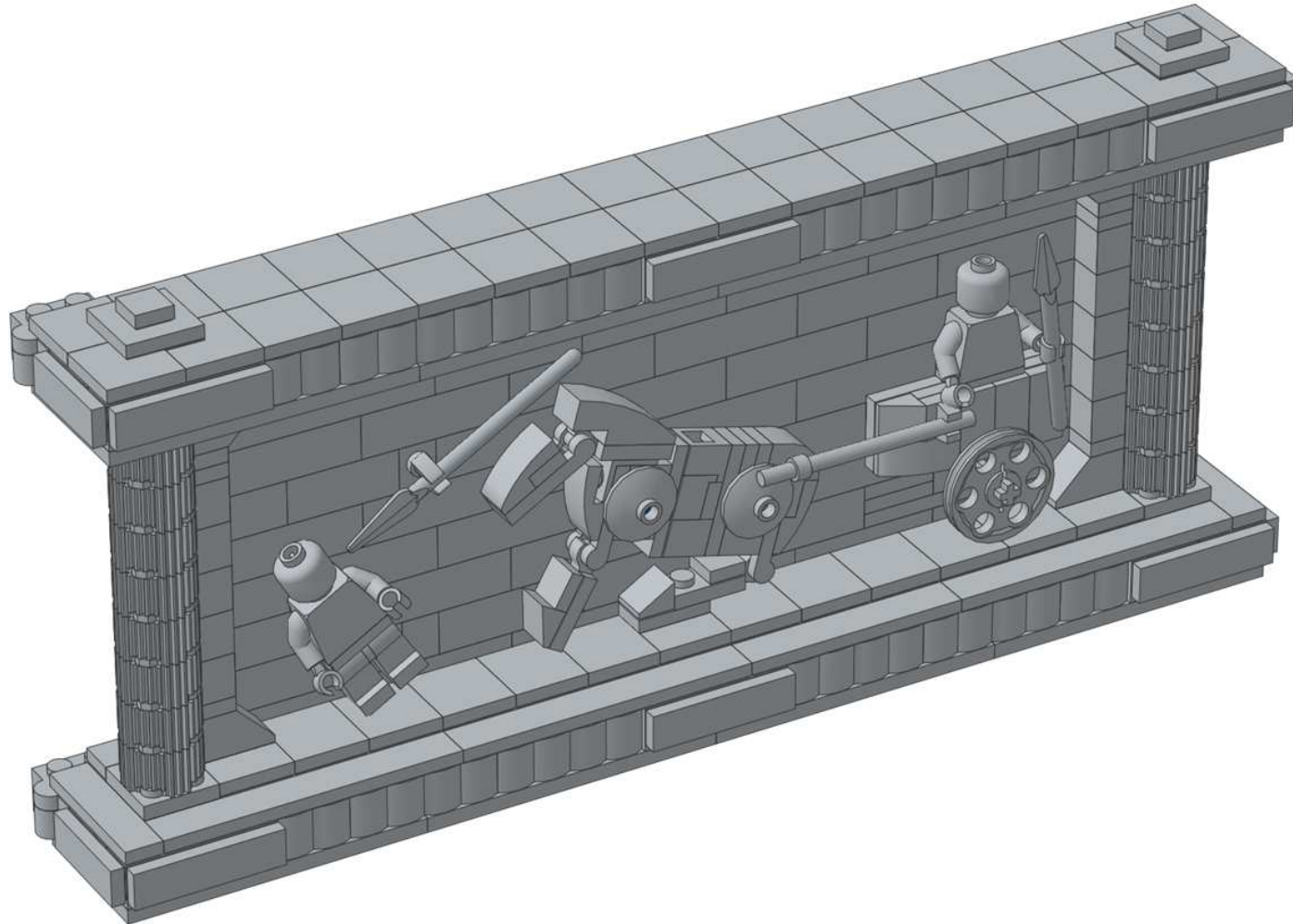

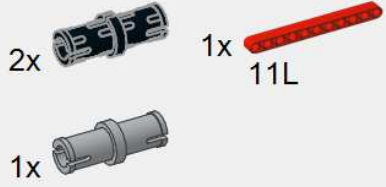
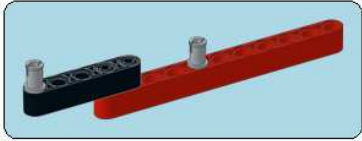

1

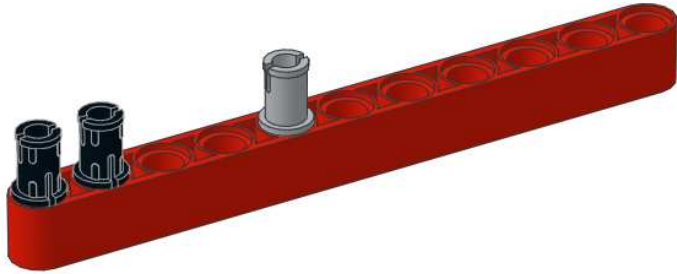

2

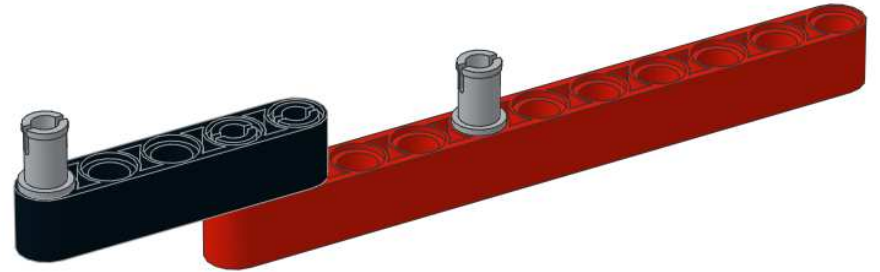

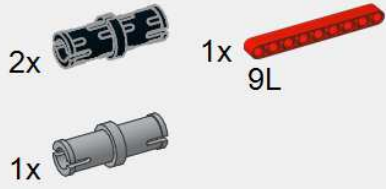
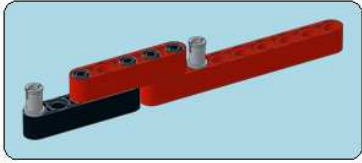

1

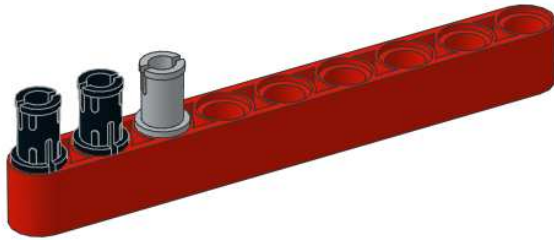

2

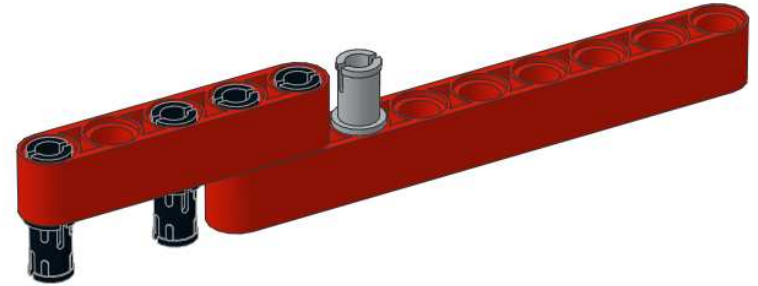



3

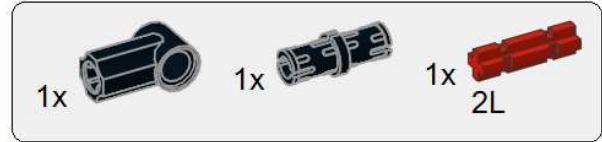

1





2

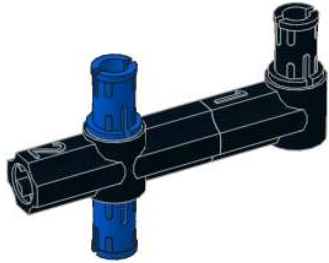

3

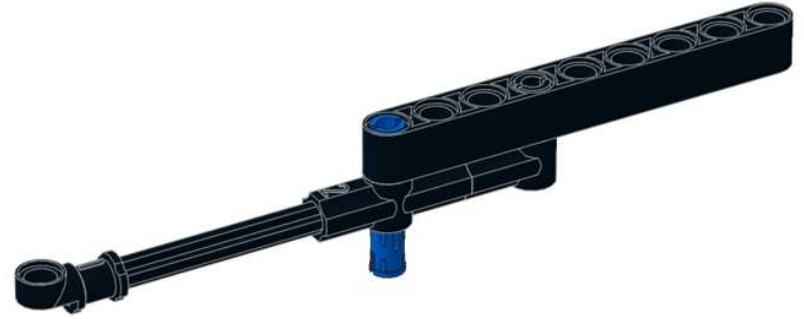

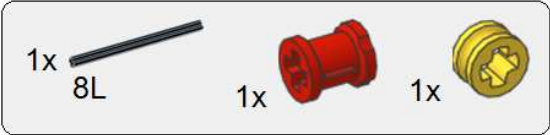
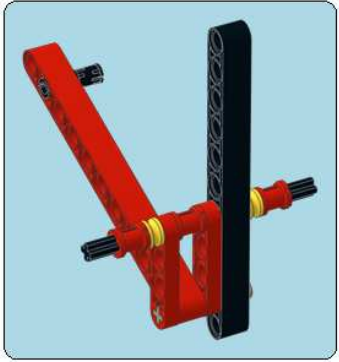

1



2

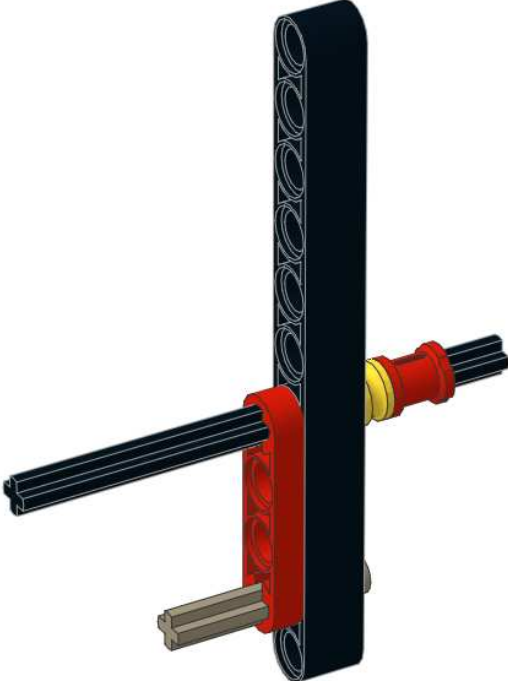

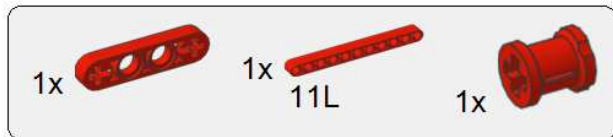

3

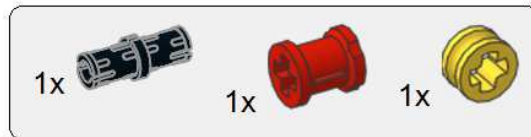

4



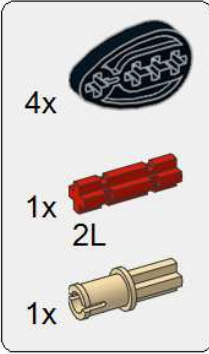
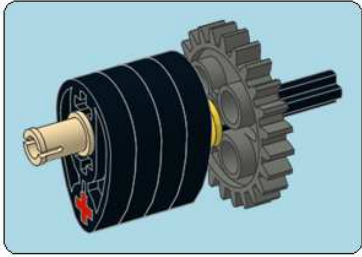

1

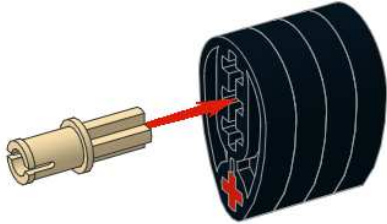

2

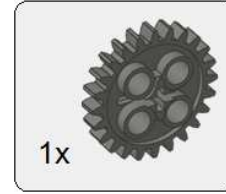
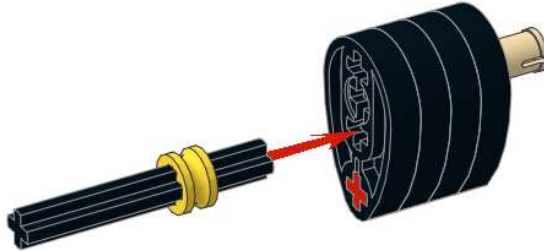

3

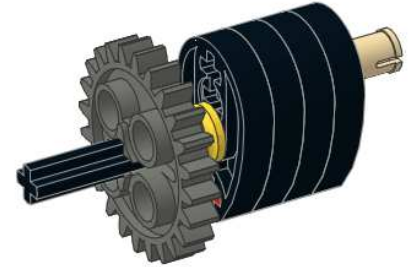

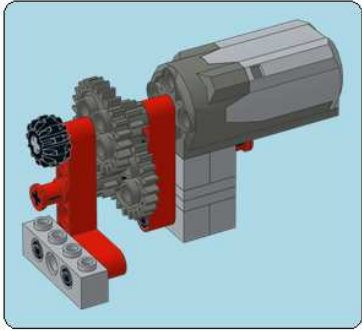

Optional drive motor

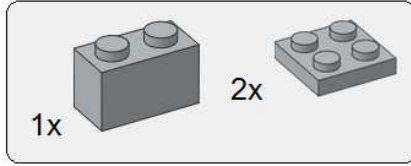

1

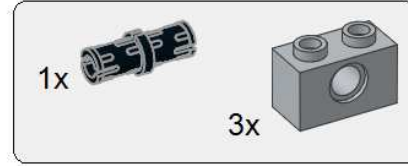
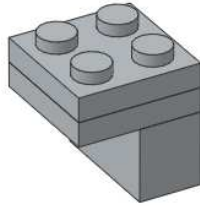

2

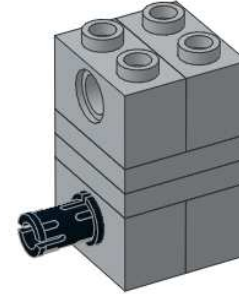

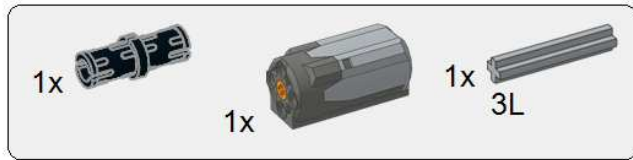

3

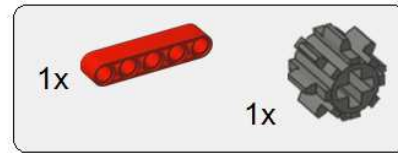
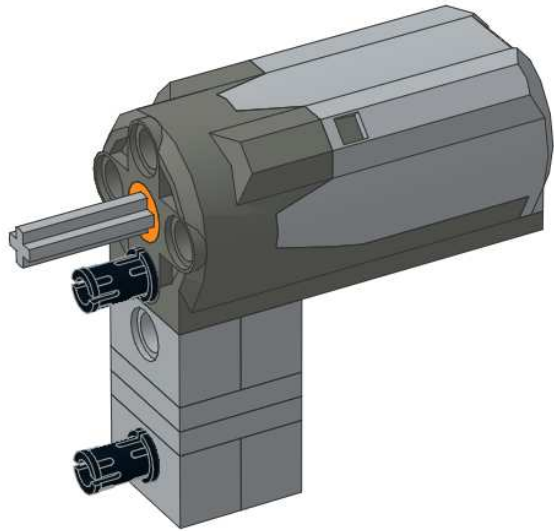

4

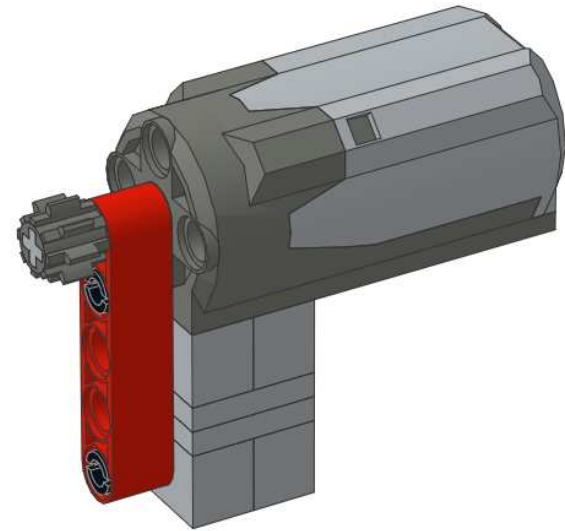

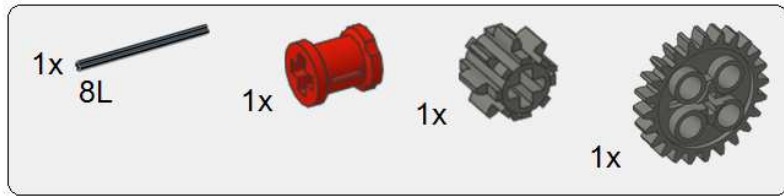

5

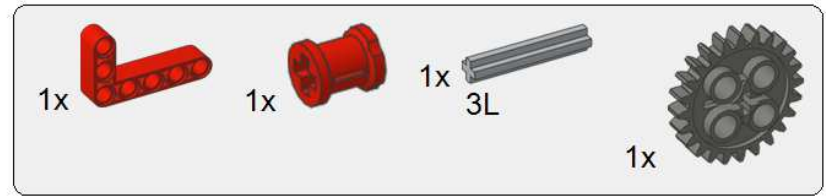
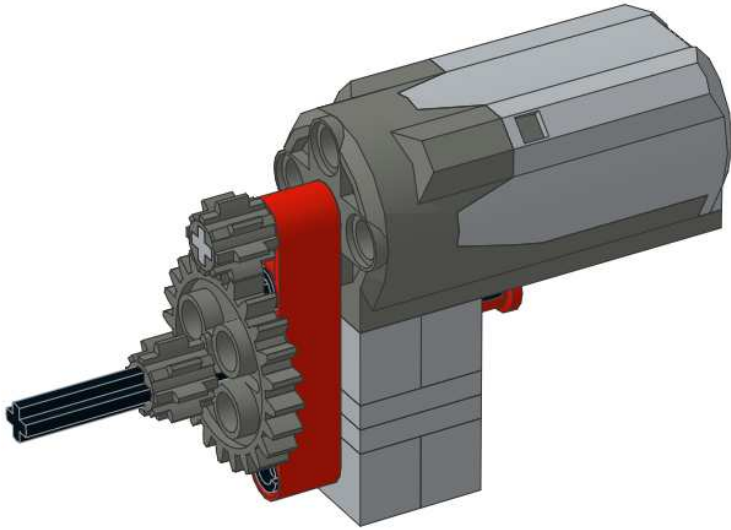

6

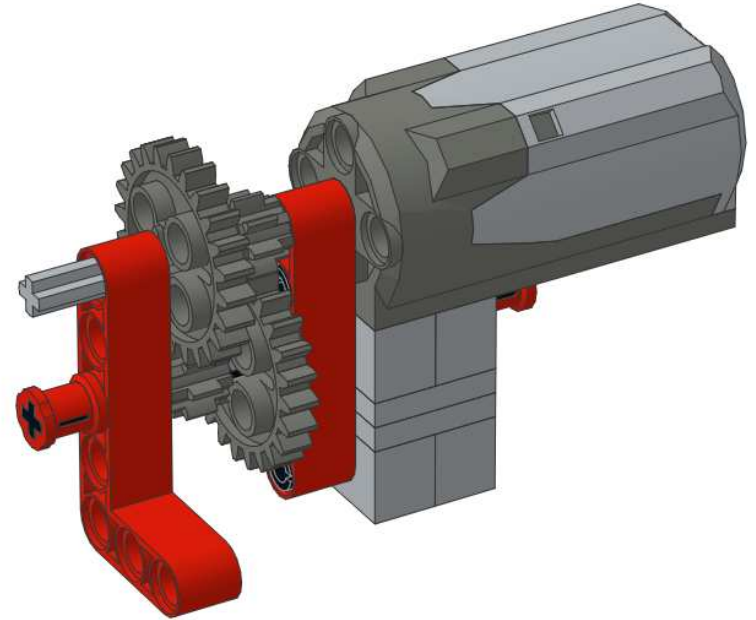

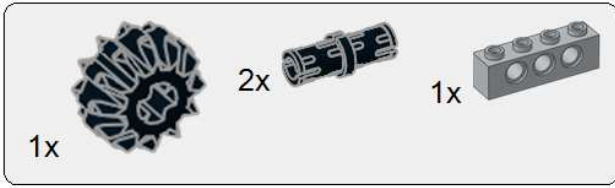

7

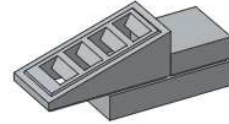
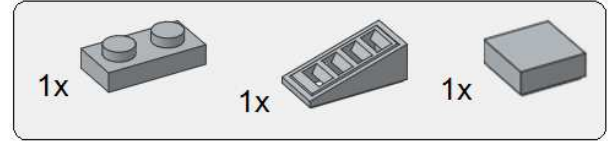
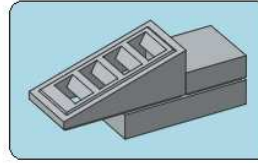
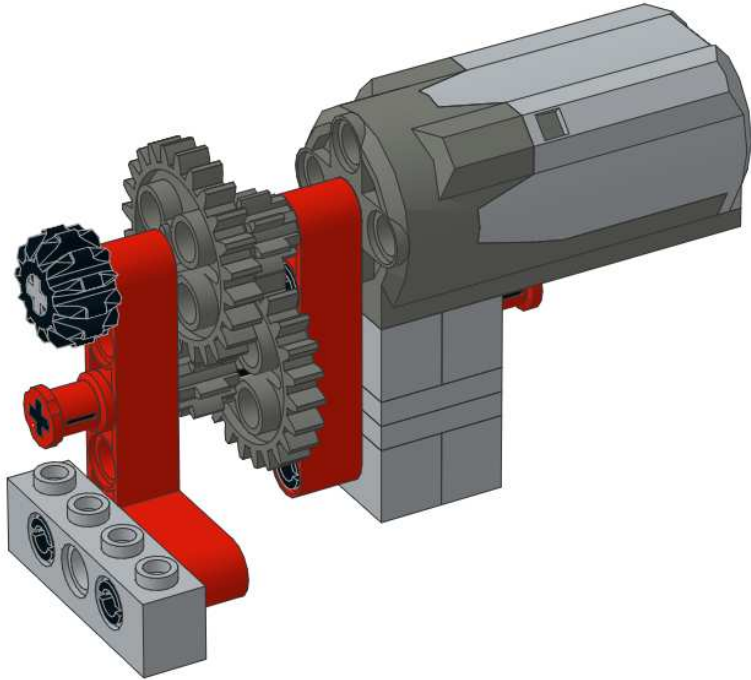

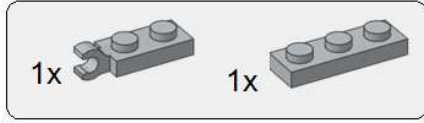
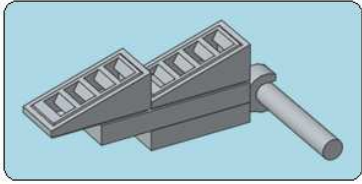

1

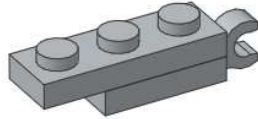

2

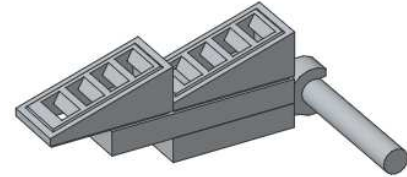

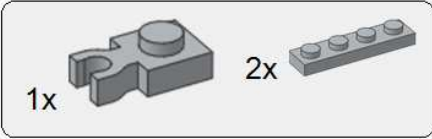
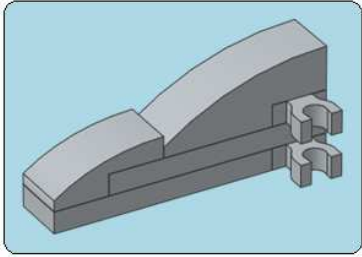

1

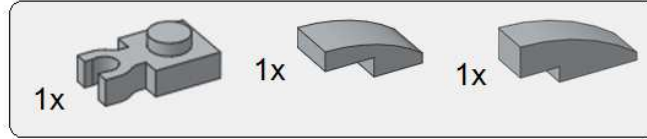
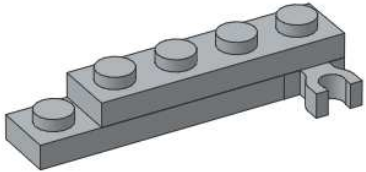

2

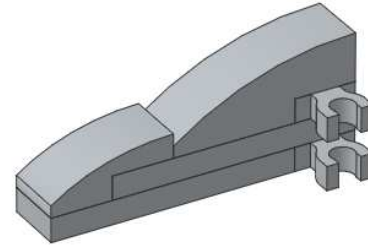

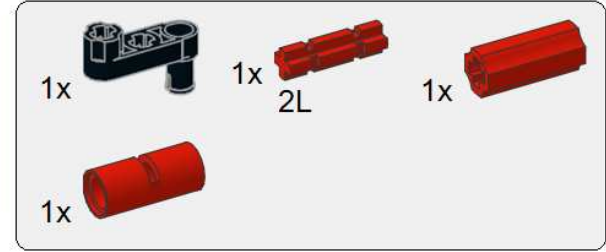
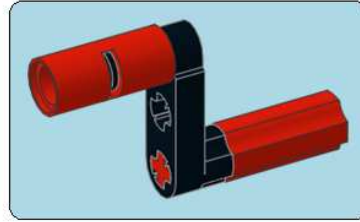
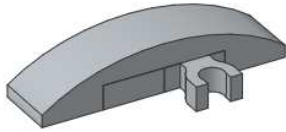
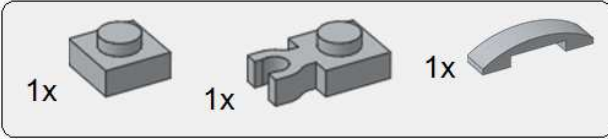
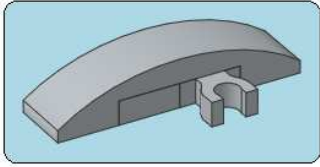

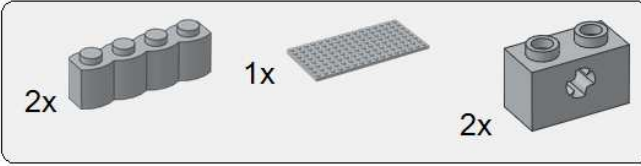
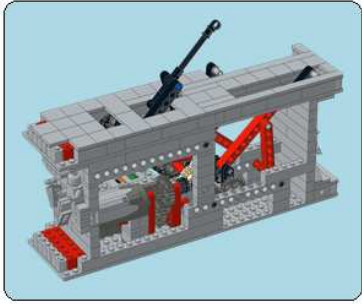

1

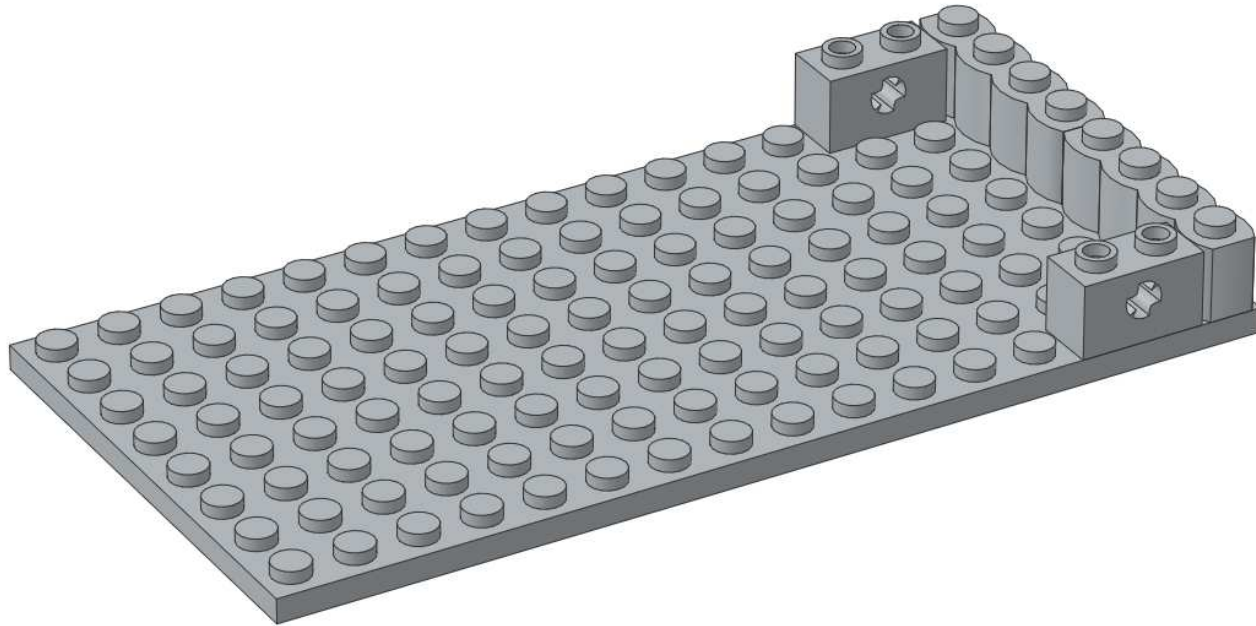

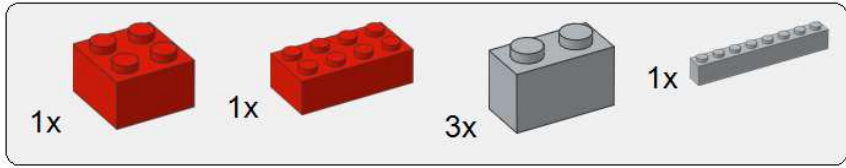

2

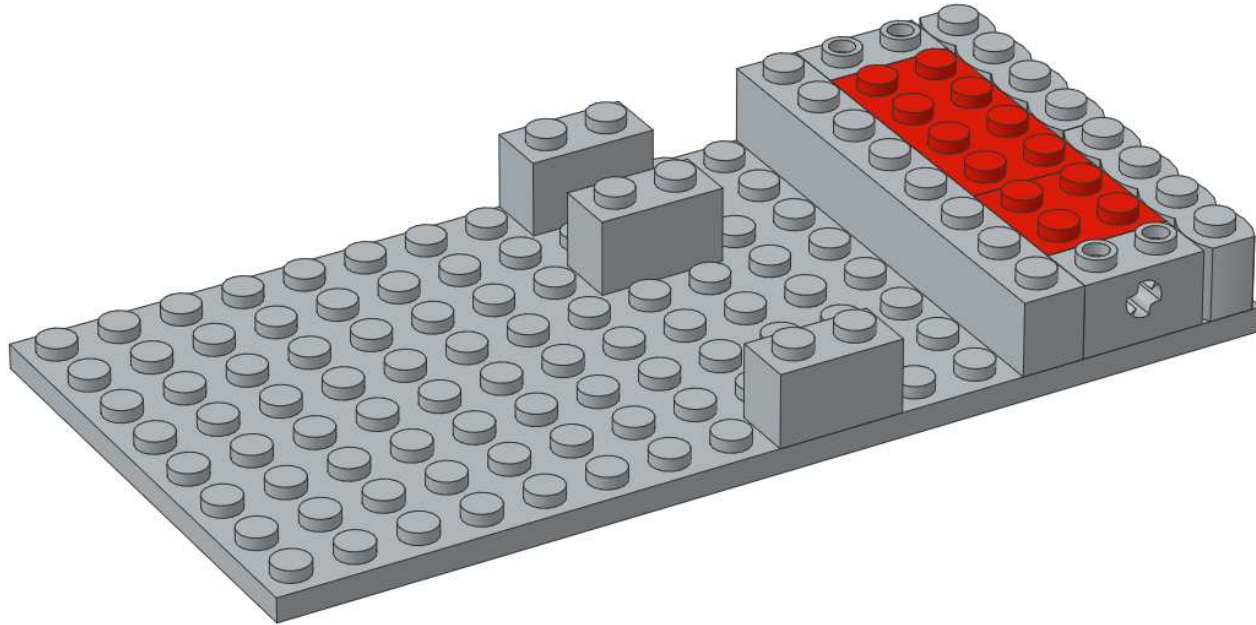



3

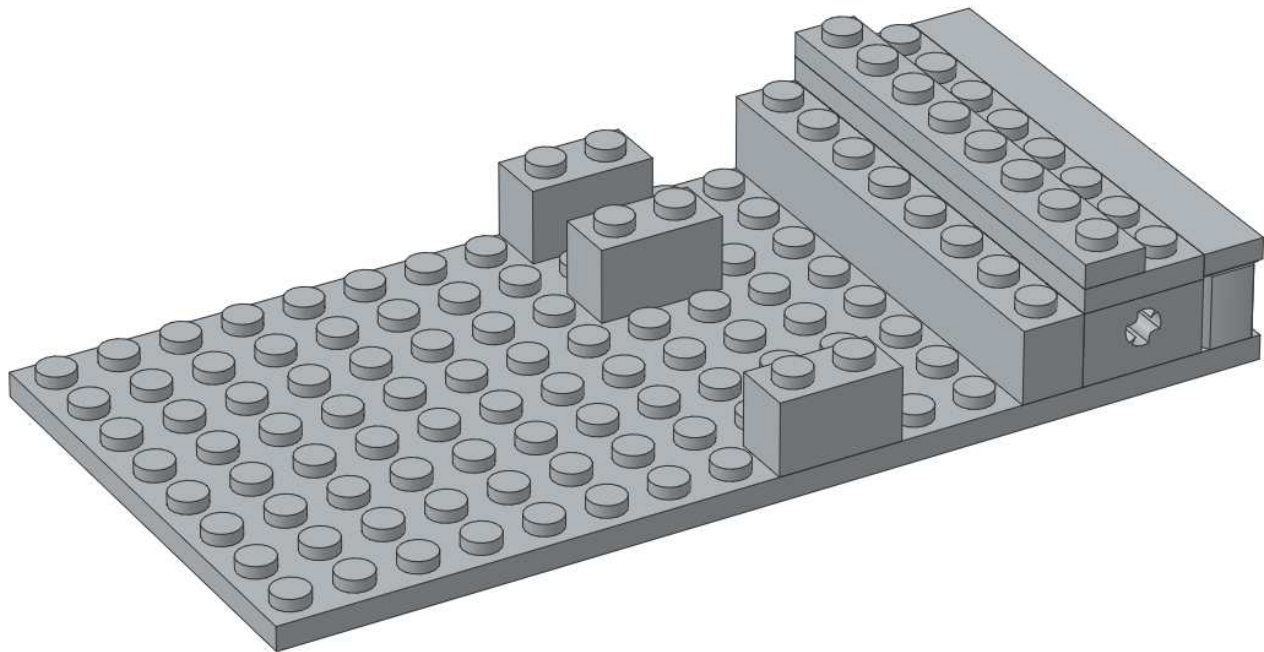



4

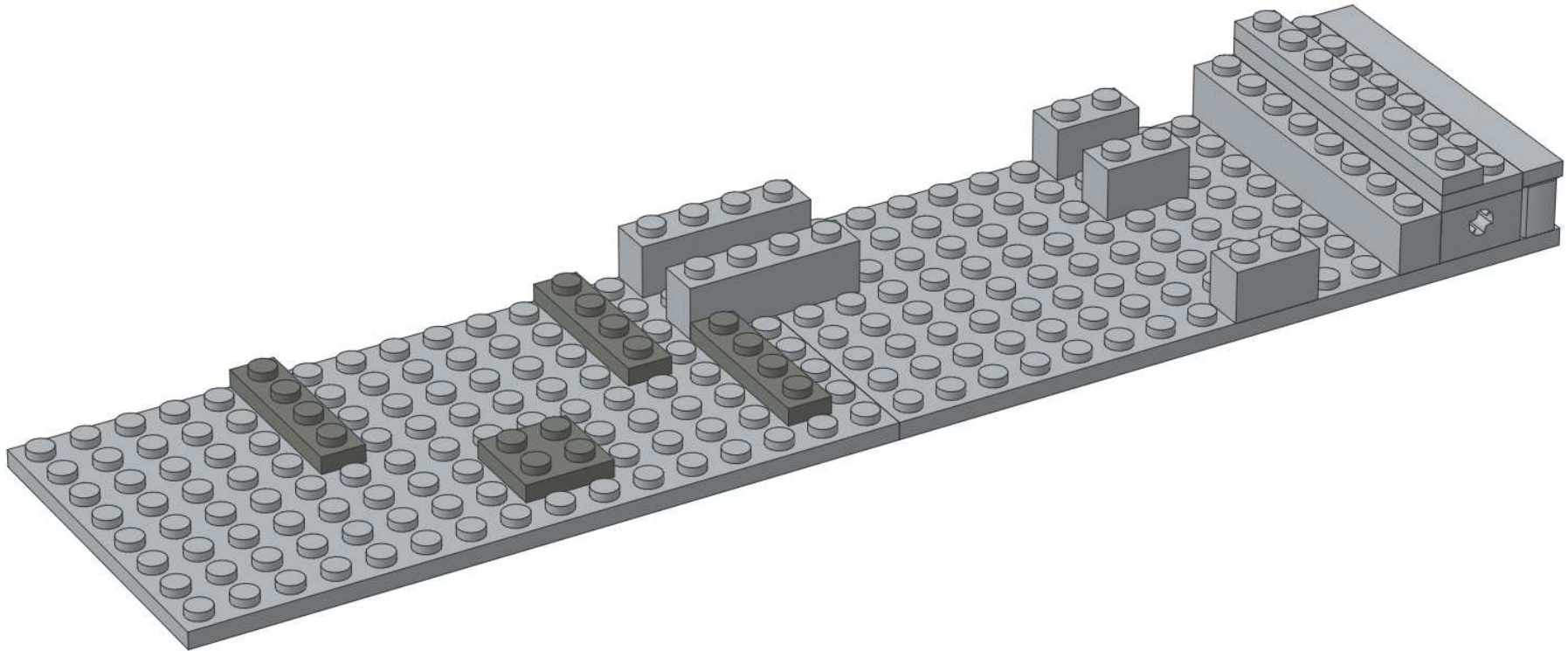

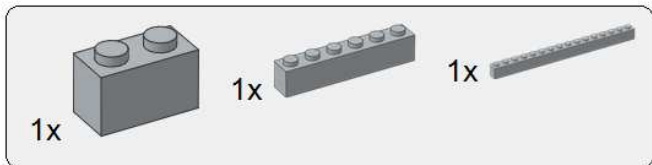

5

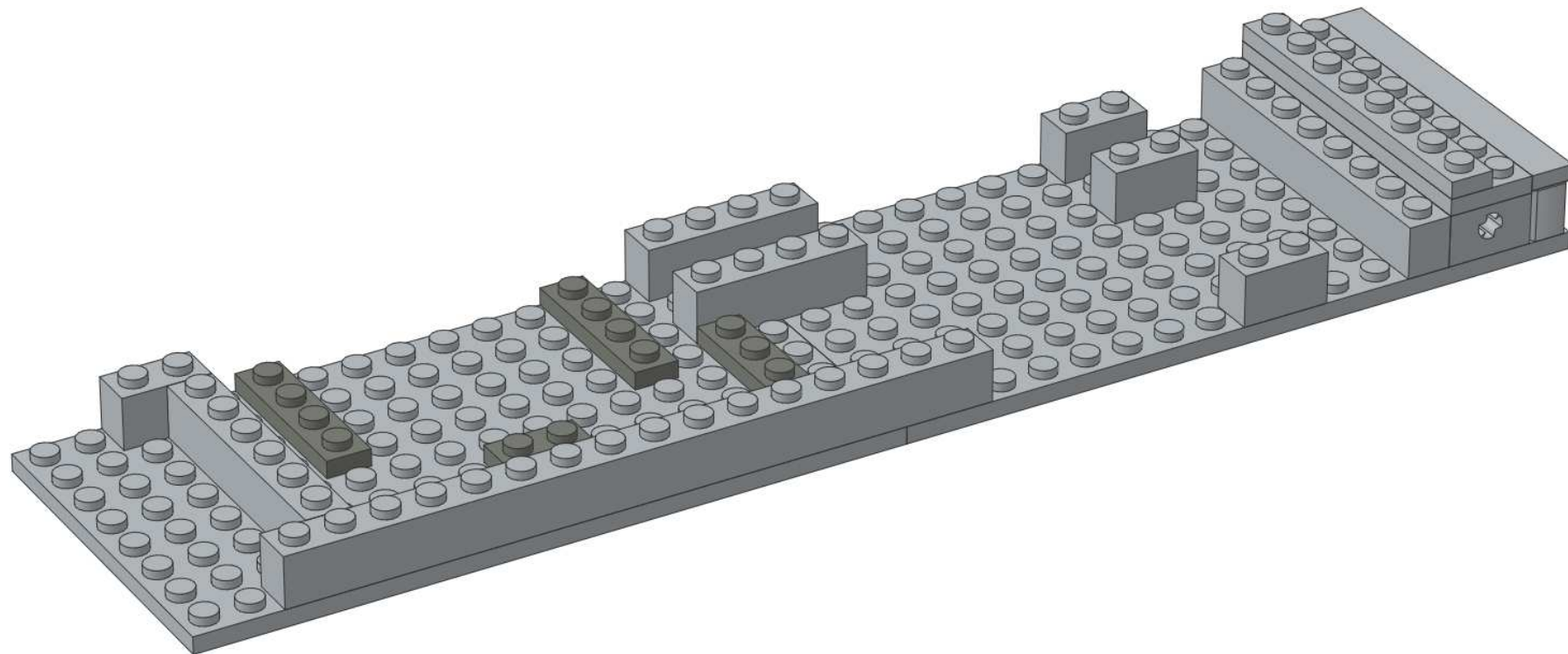

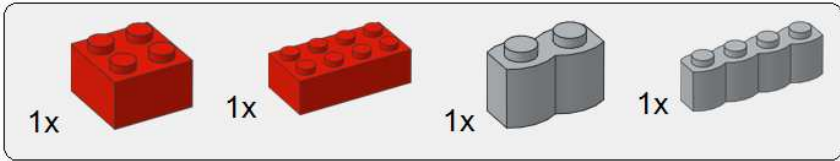

6

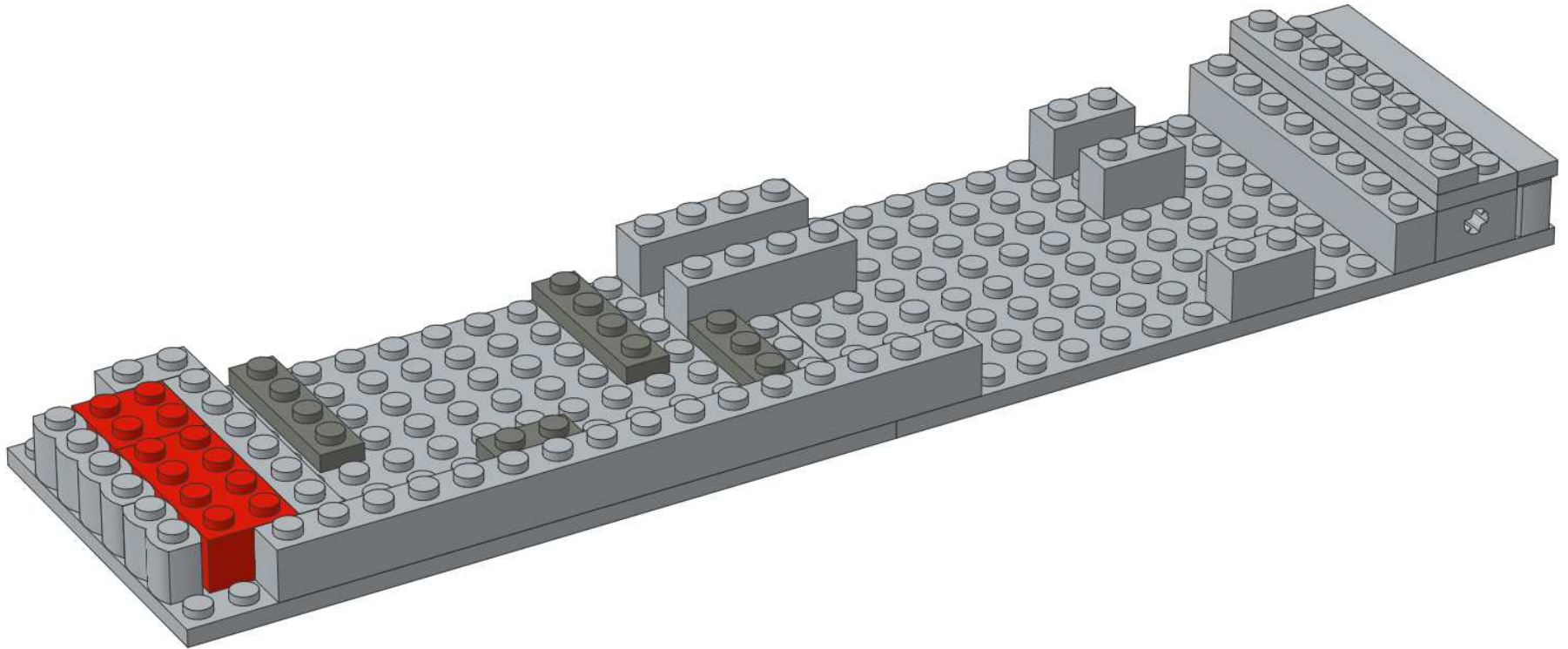

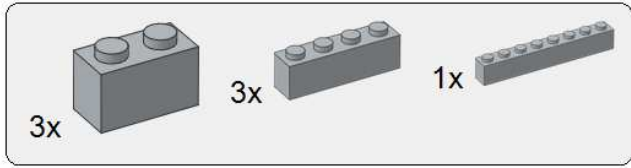

7

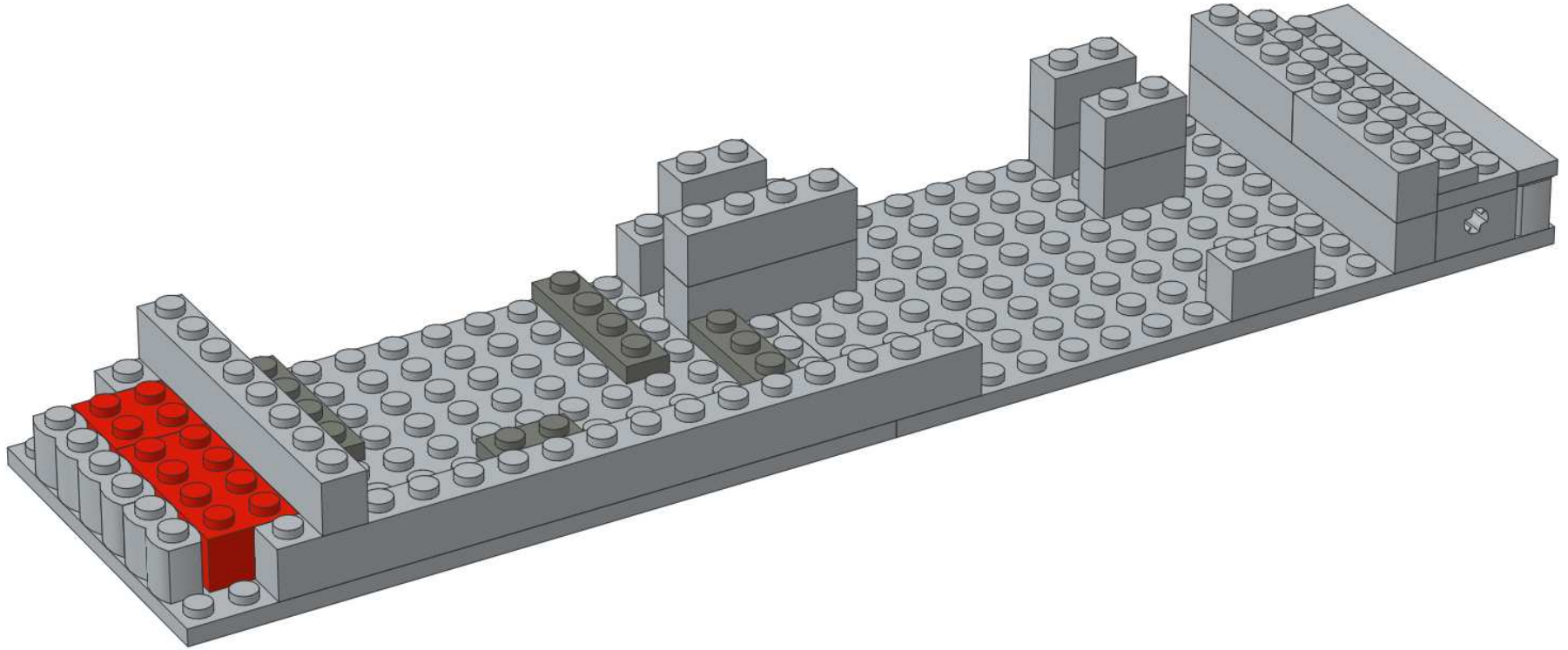

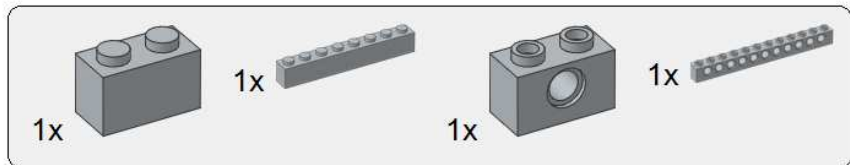

8

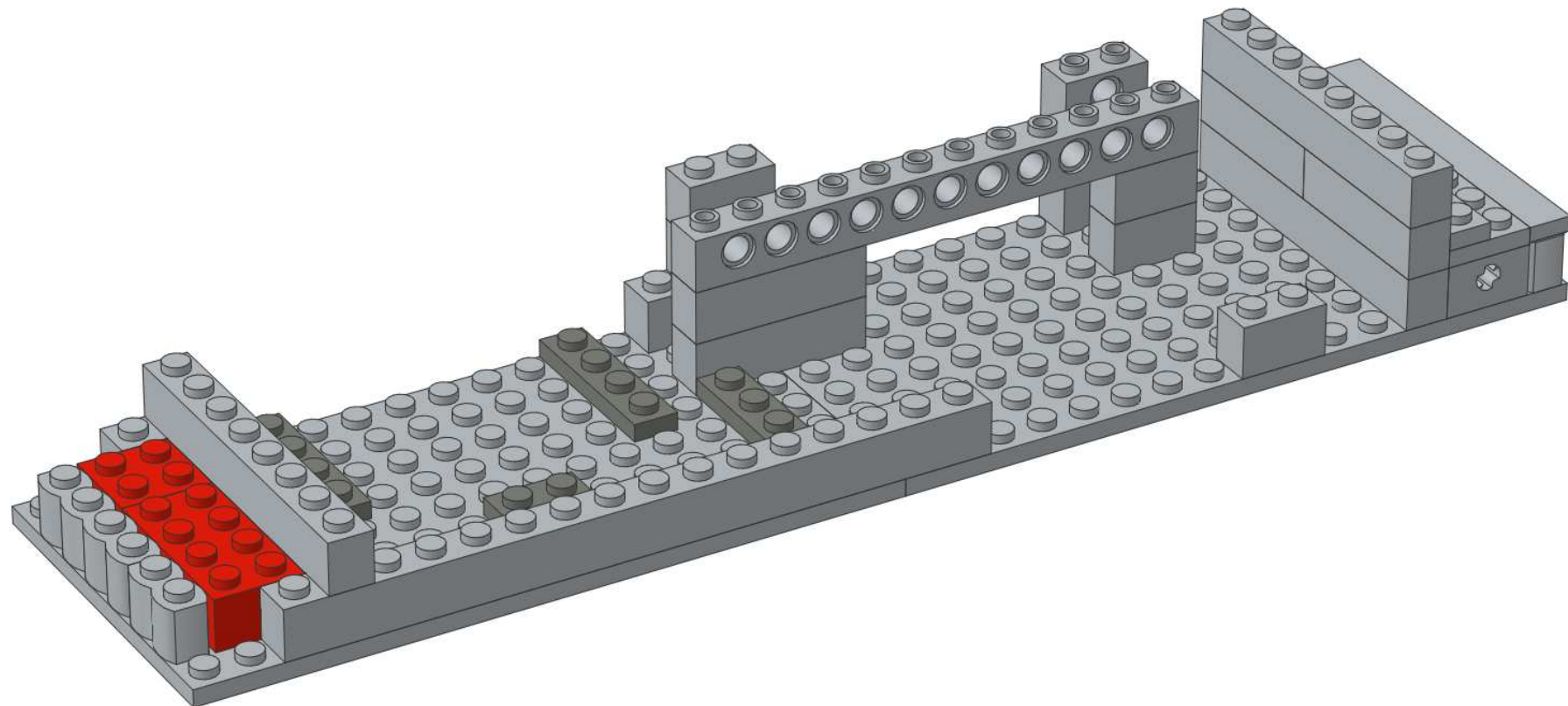

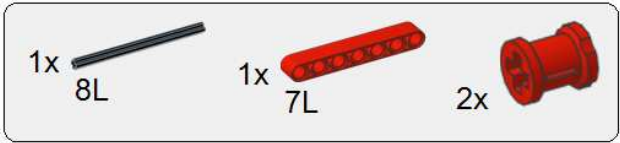

9

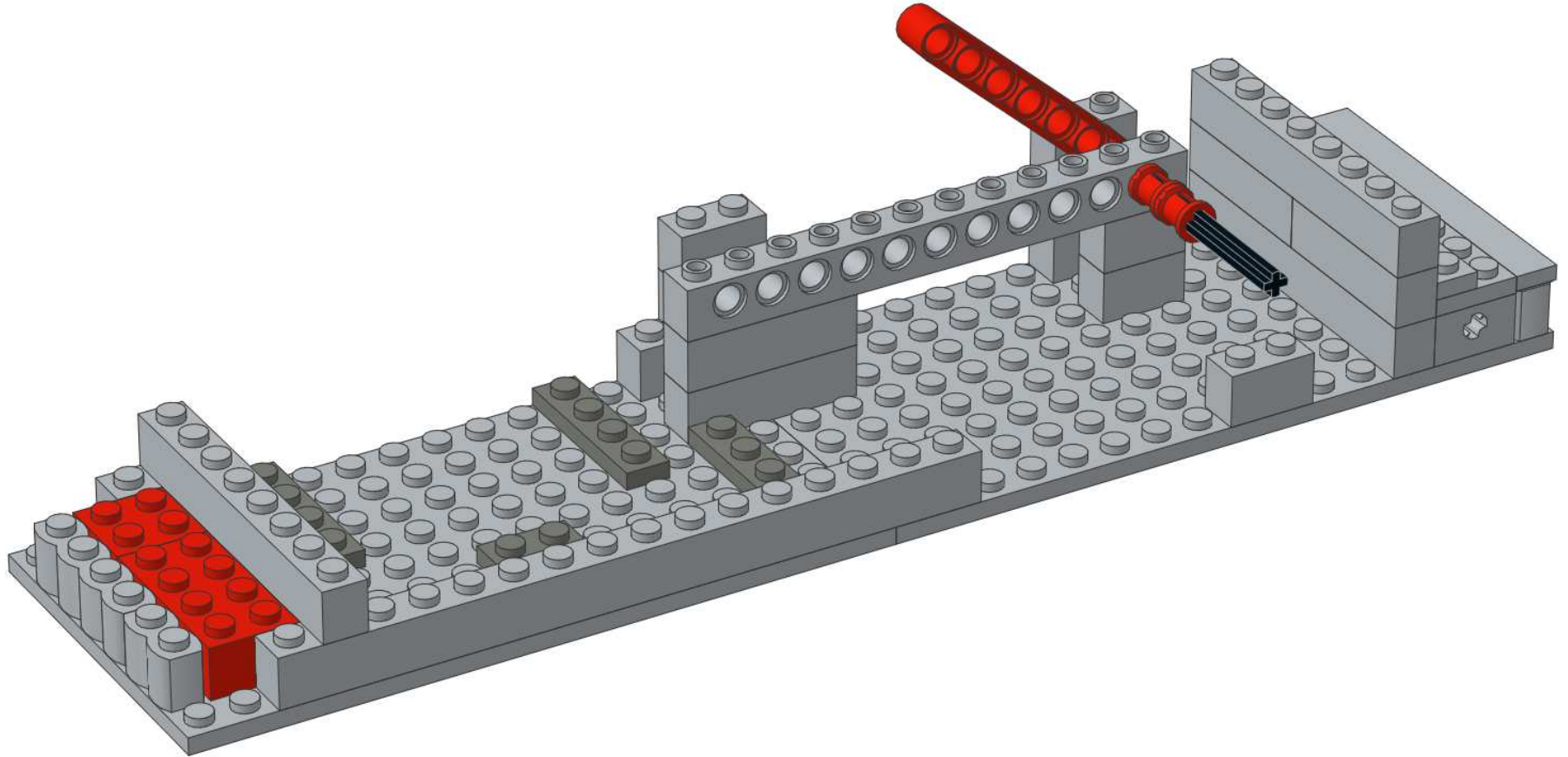



10

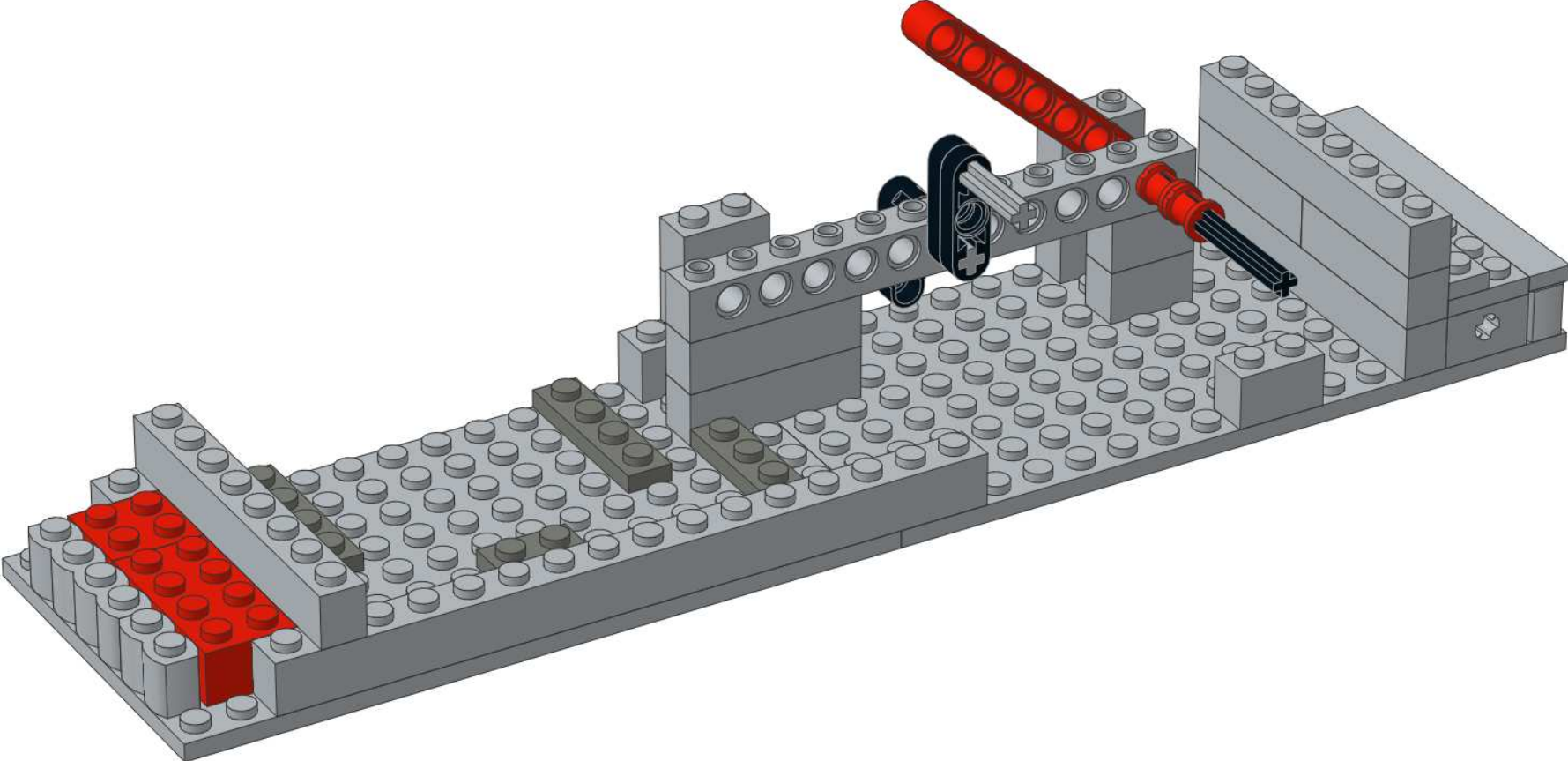



11

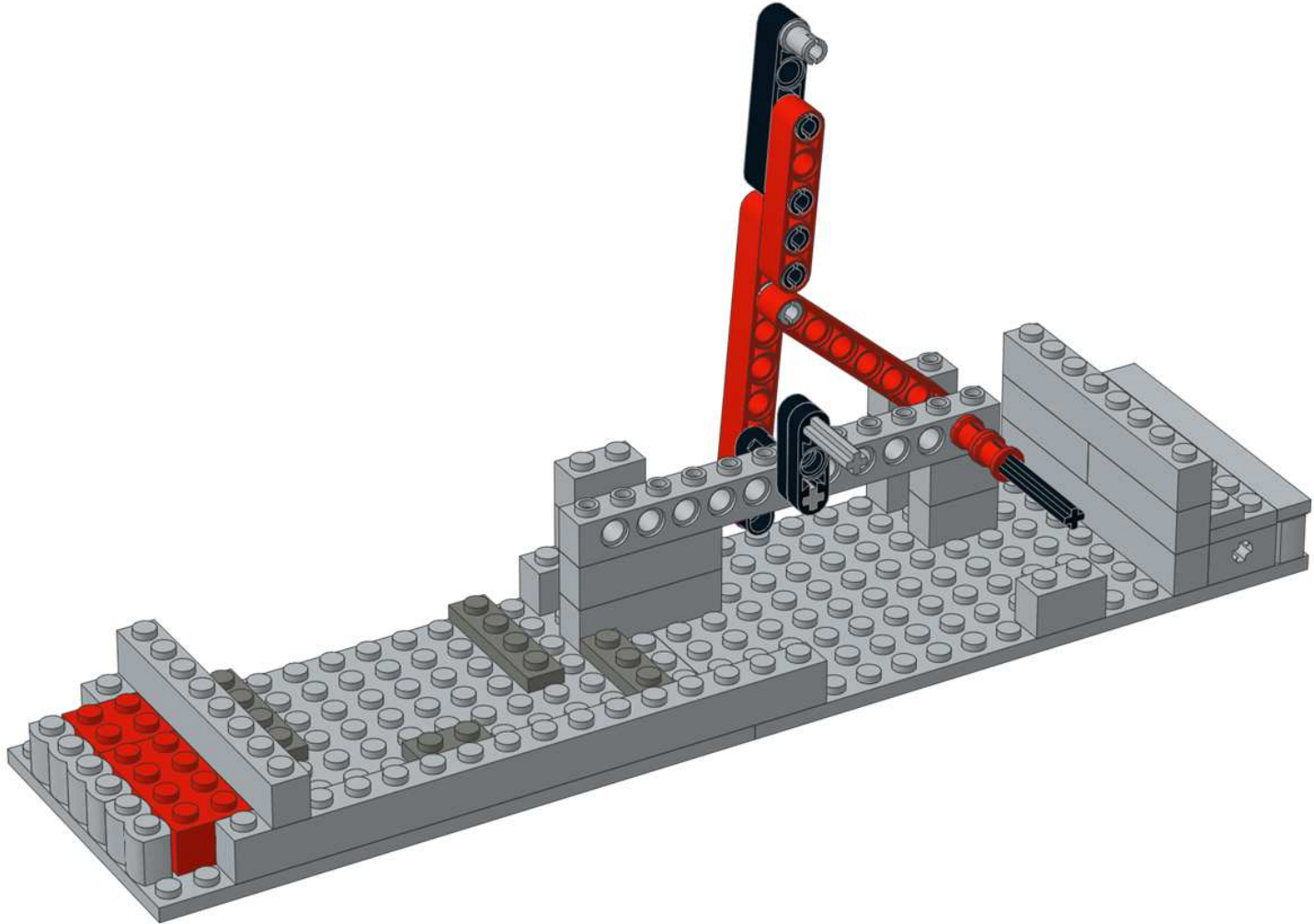

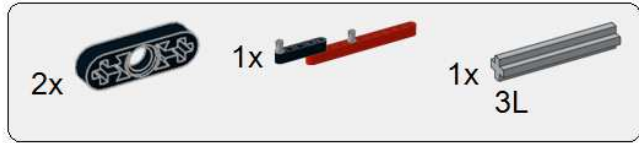

12

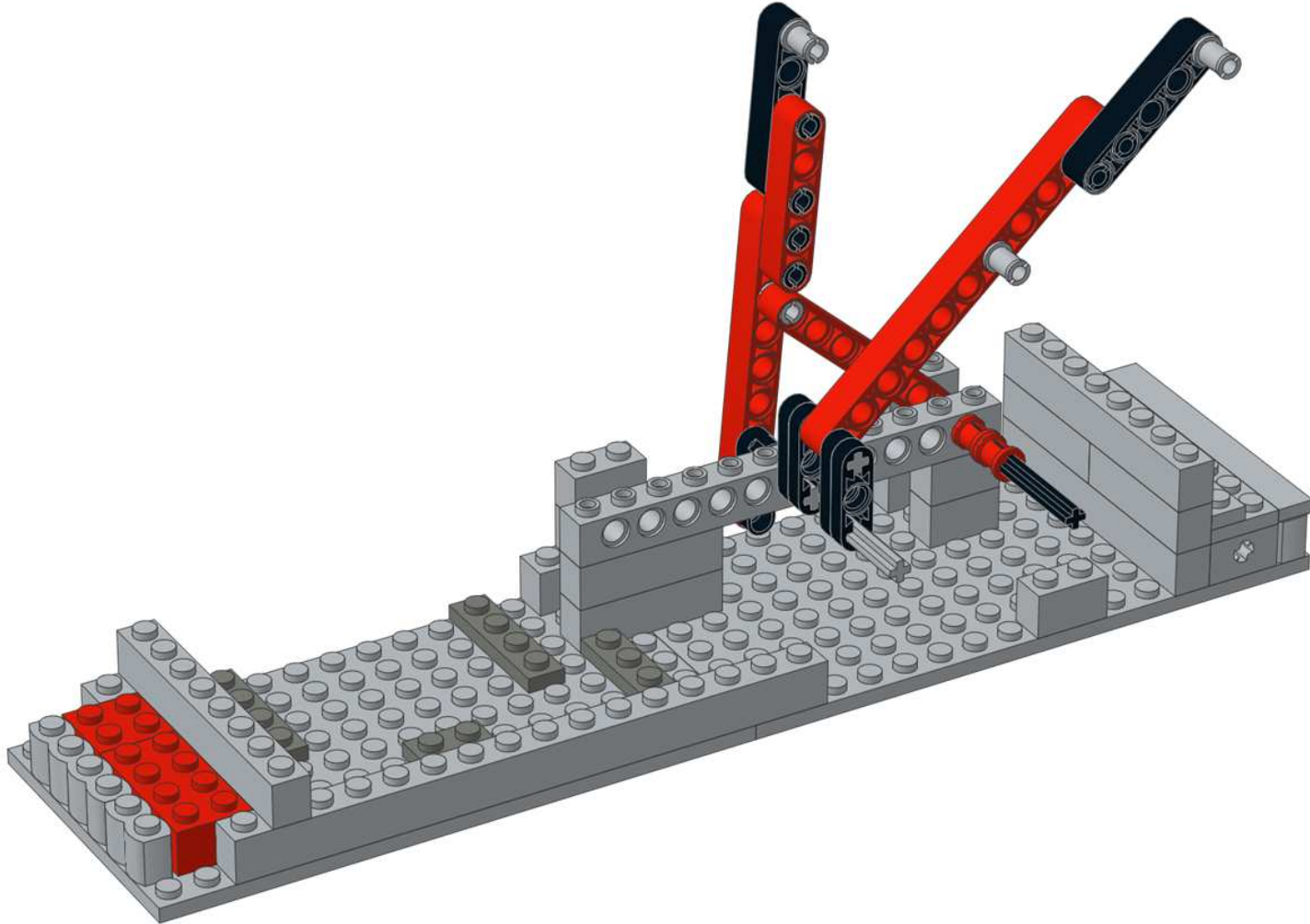

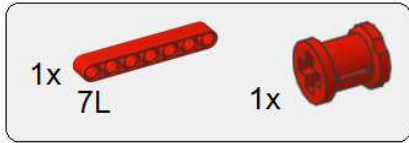

13

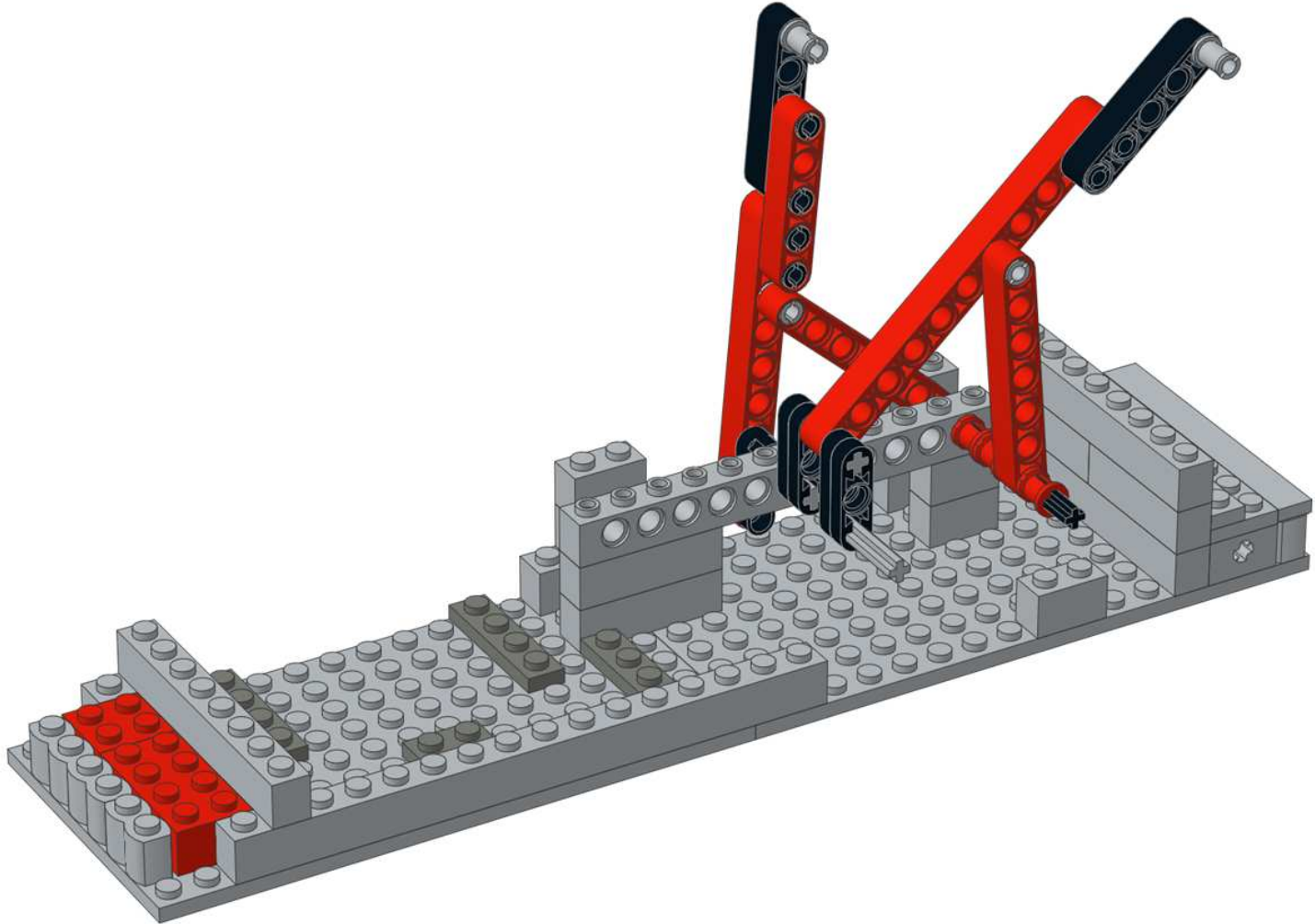

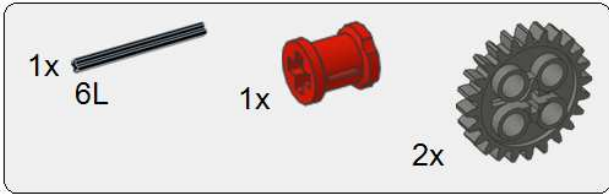

14

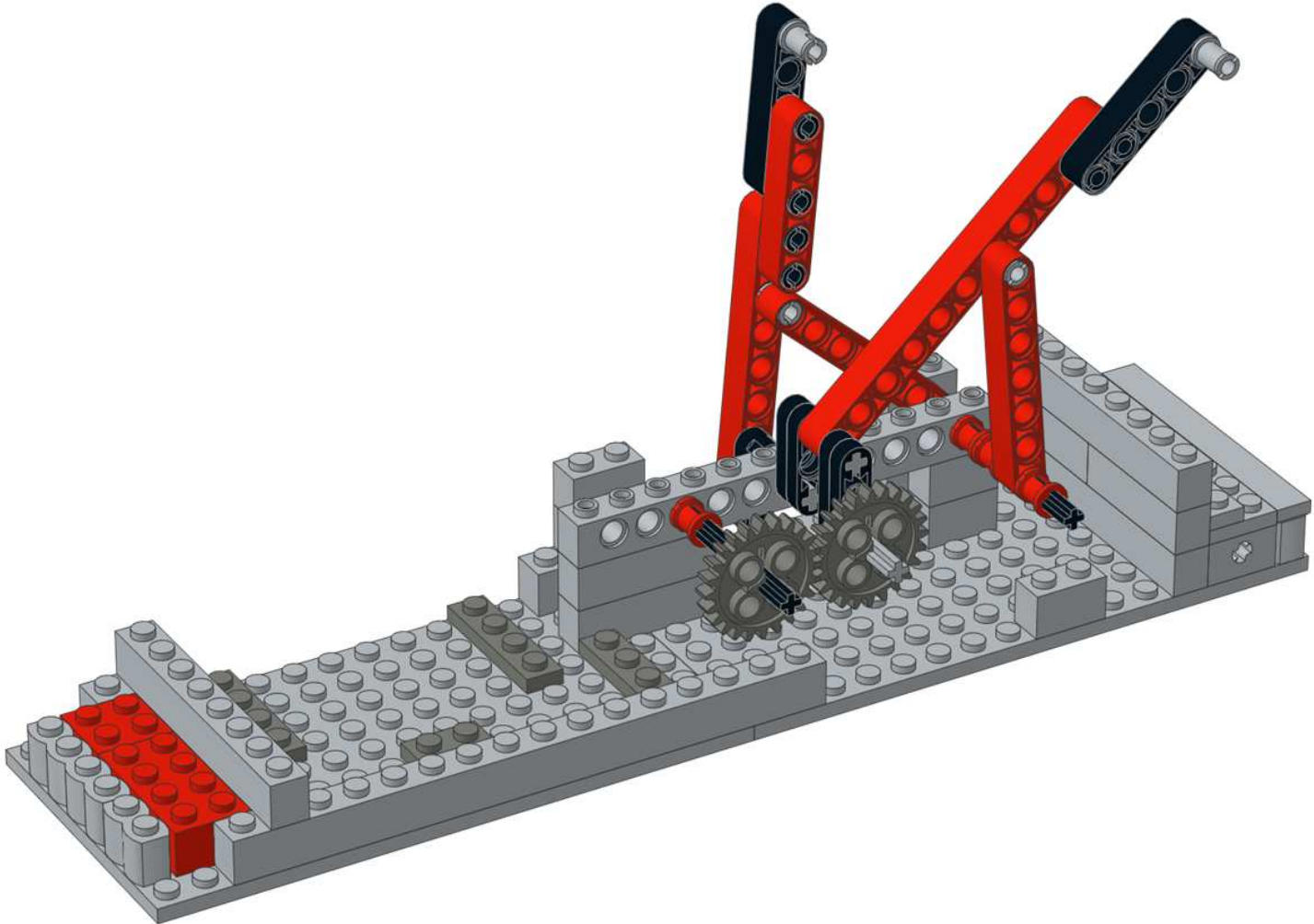

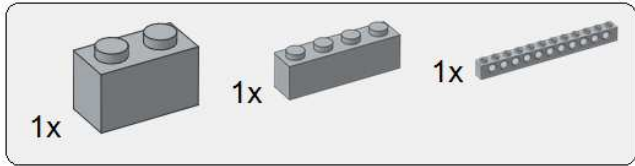

15

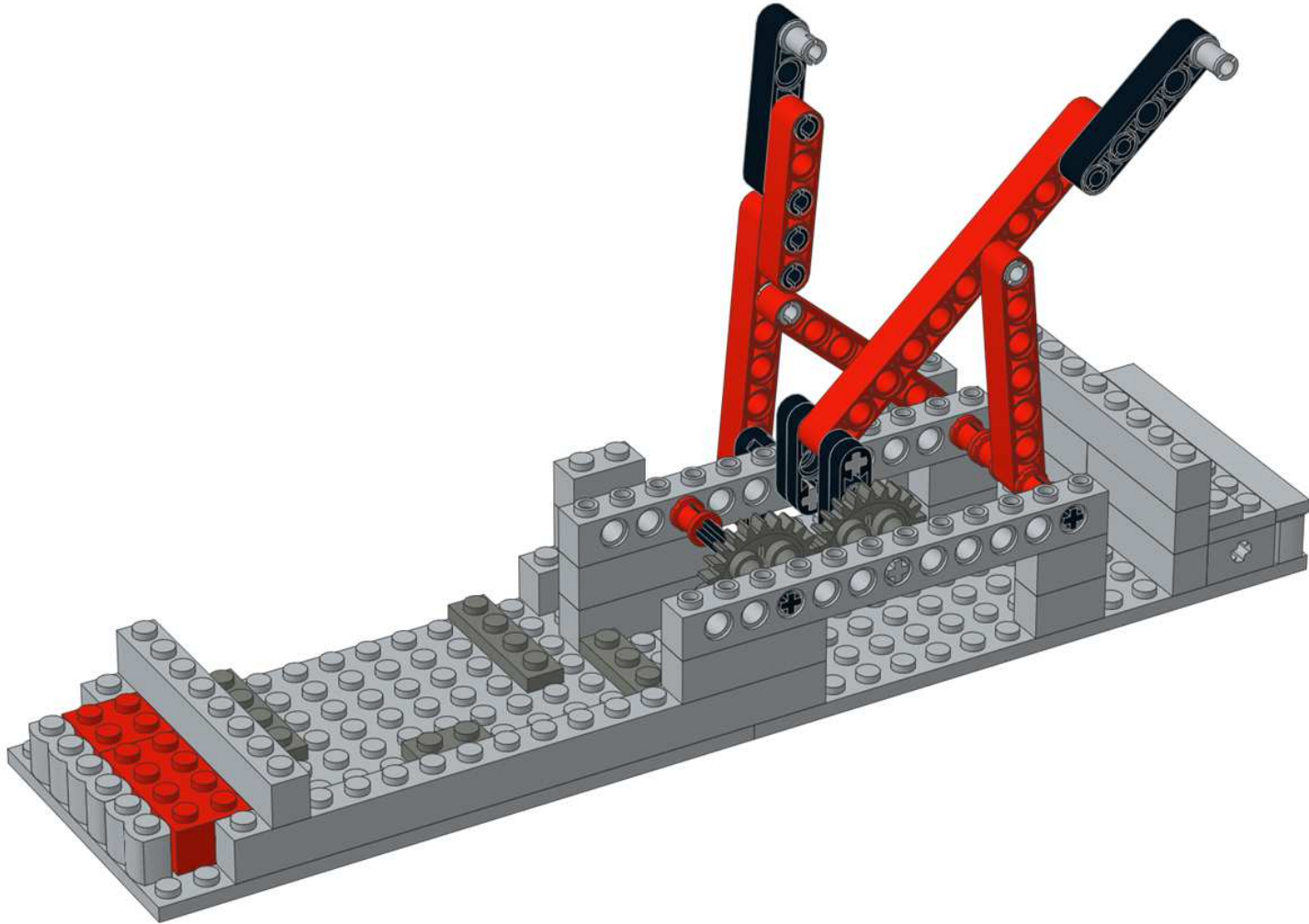

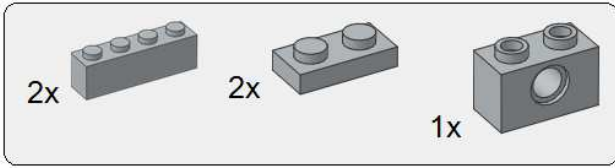

16

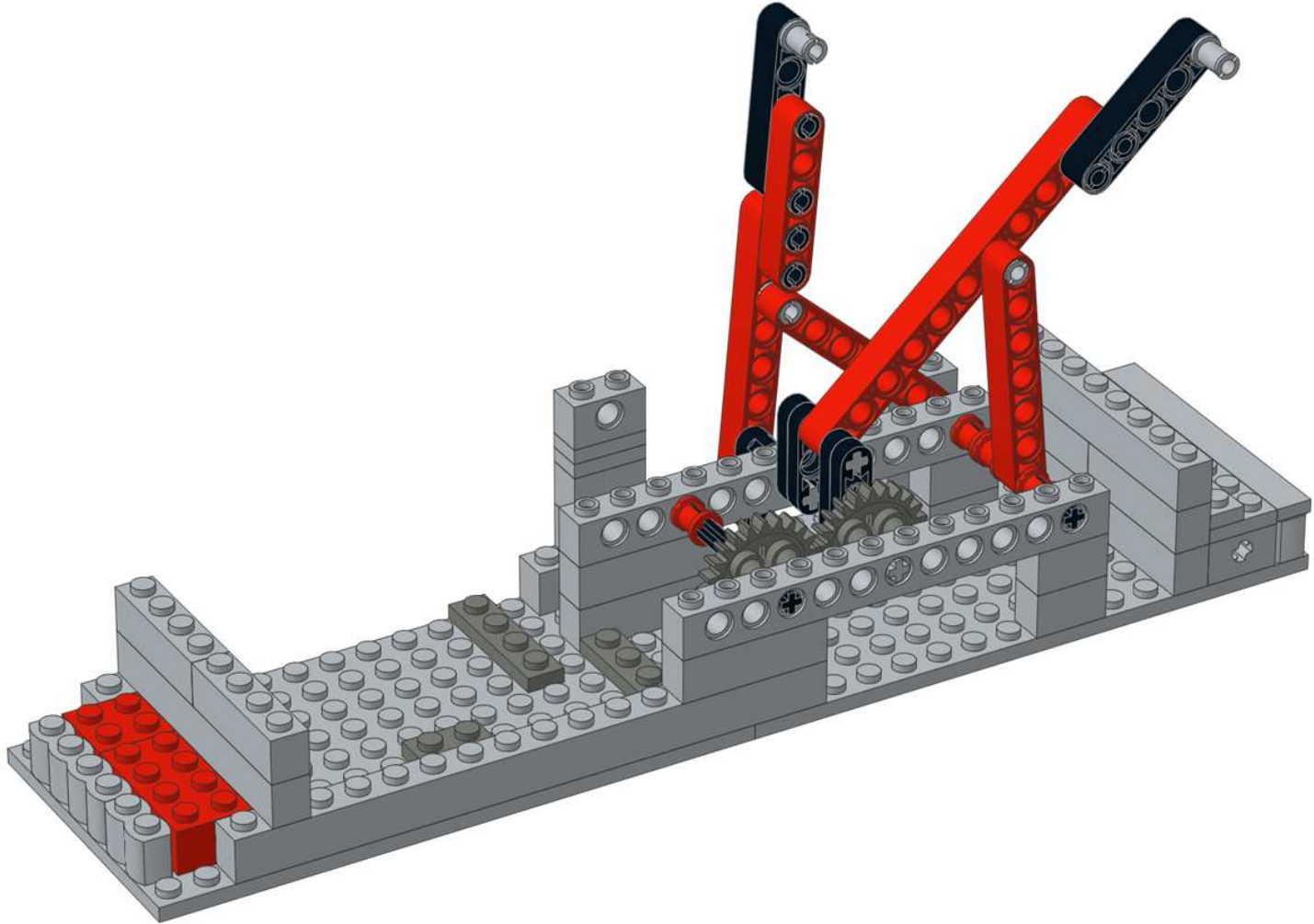

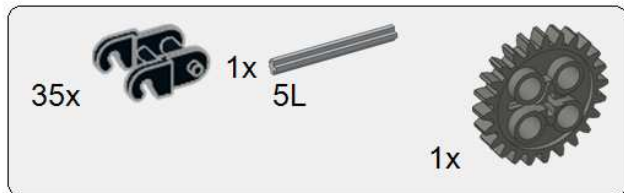

17

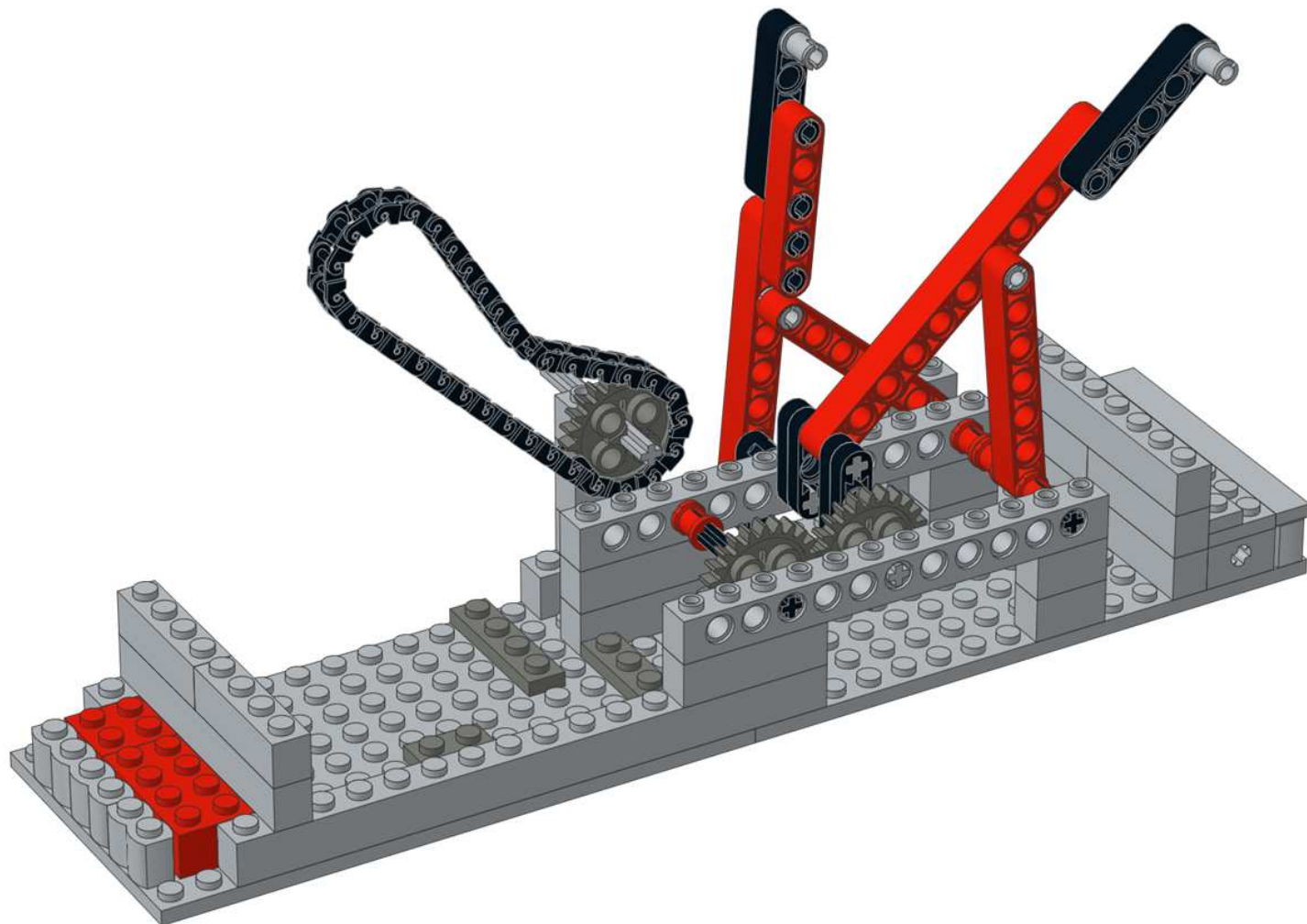

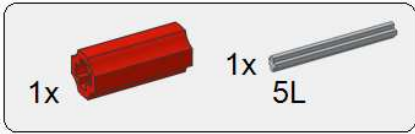

18

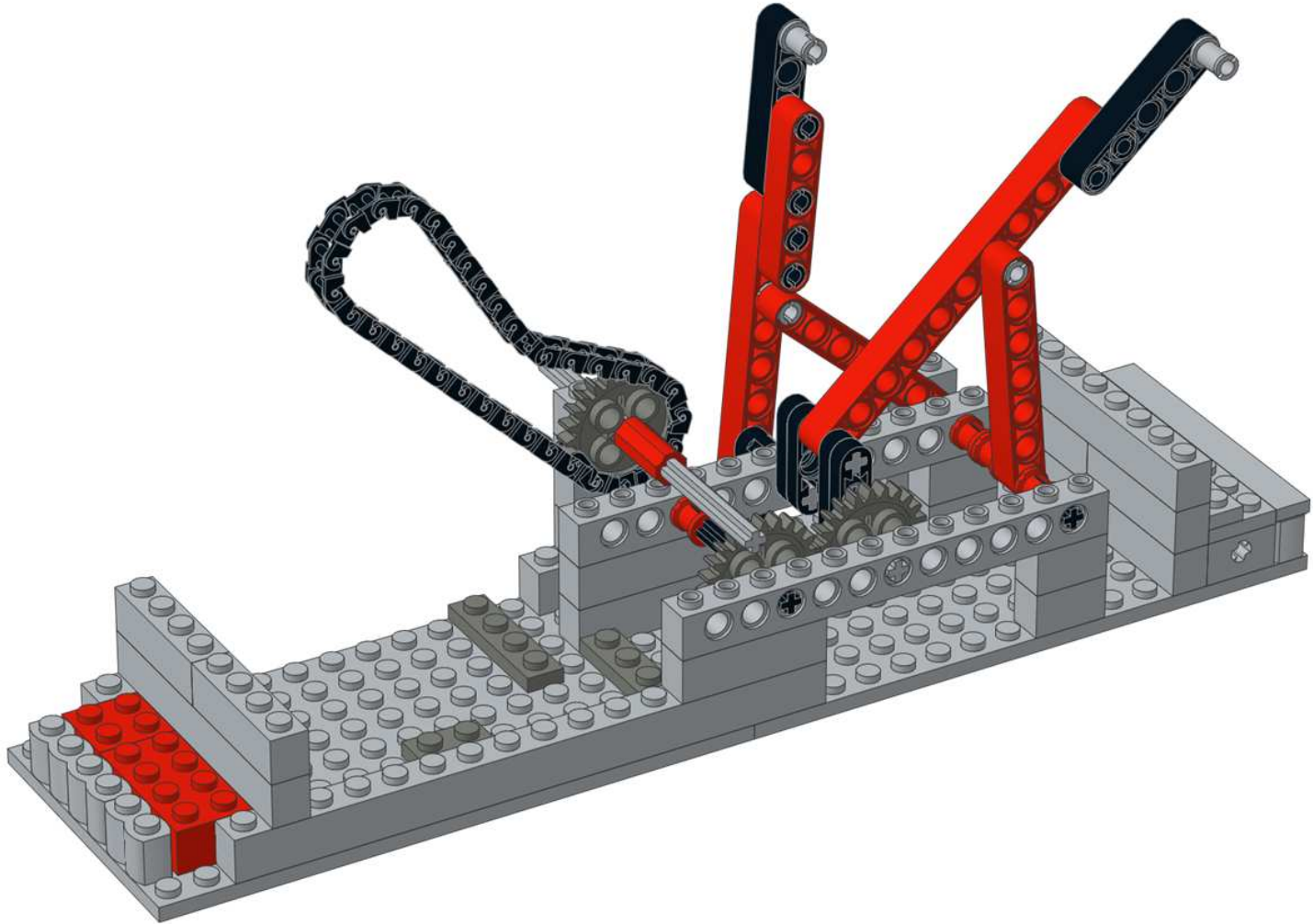

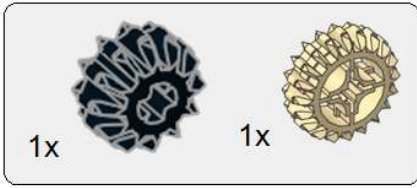

19

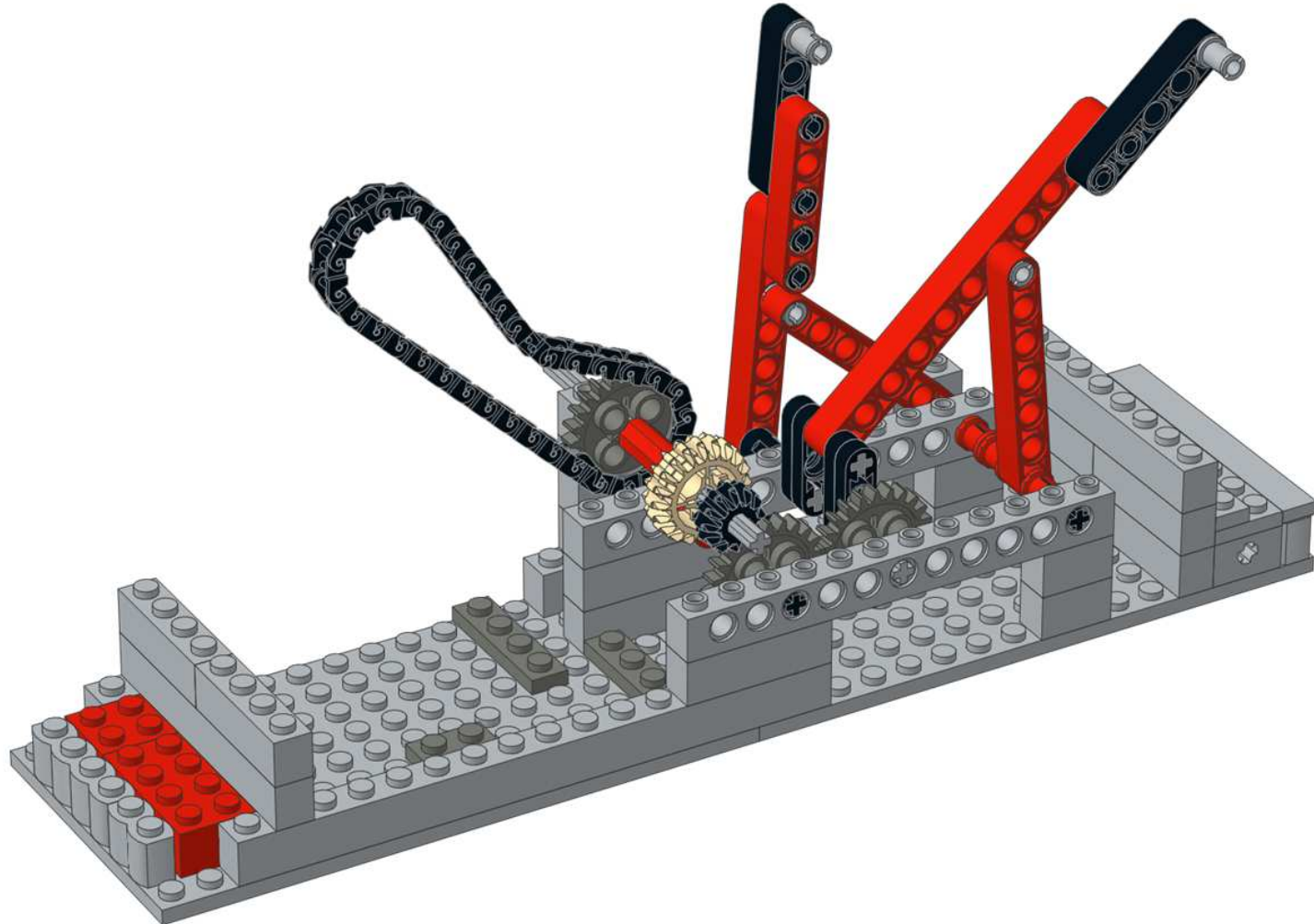

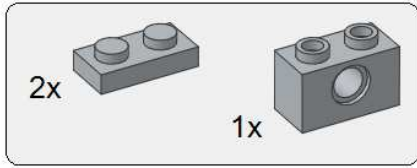

20

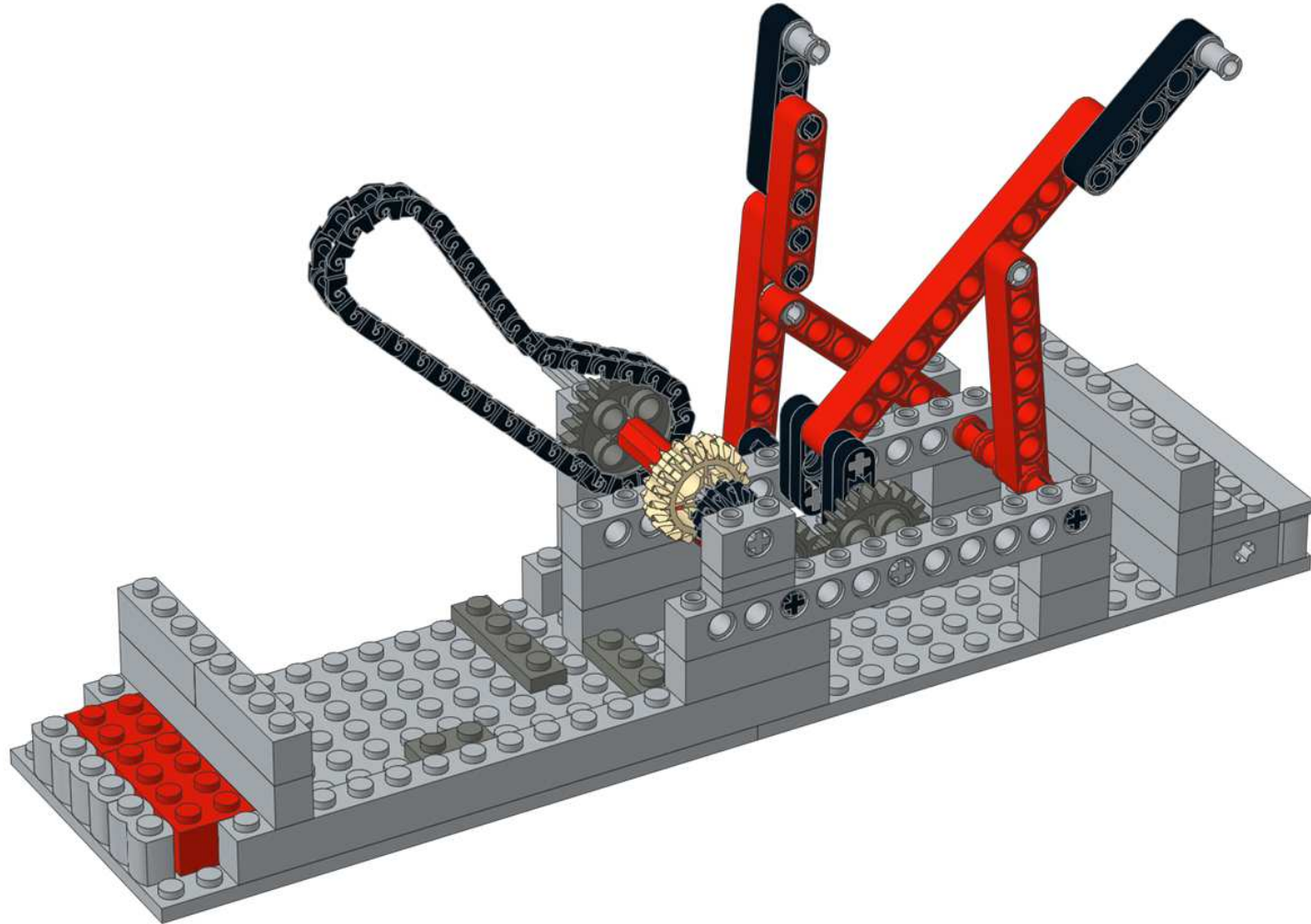

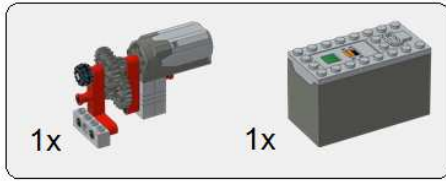

21 Optional drive motor

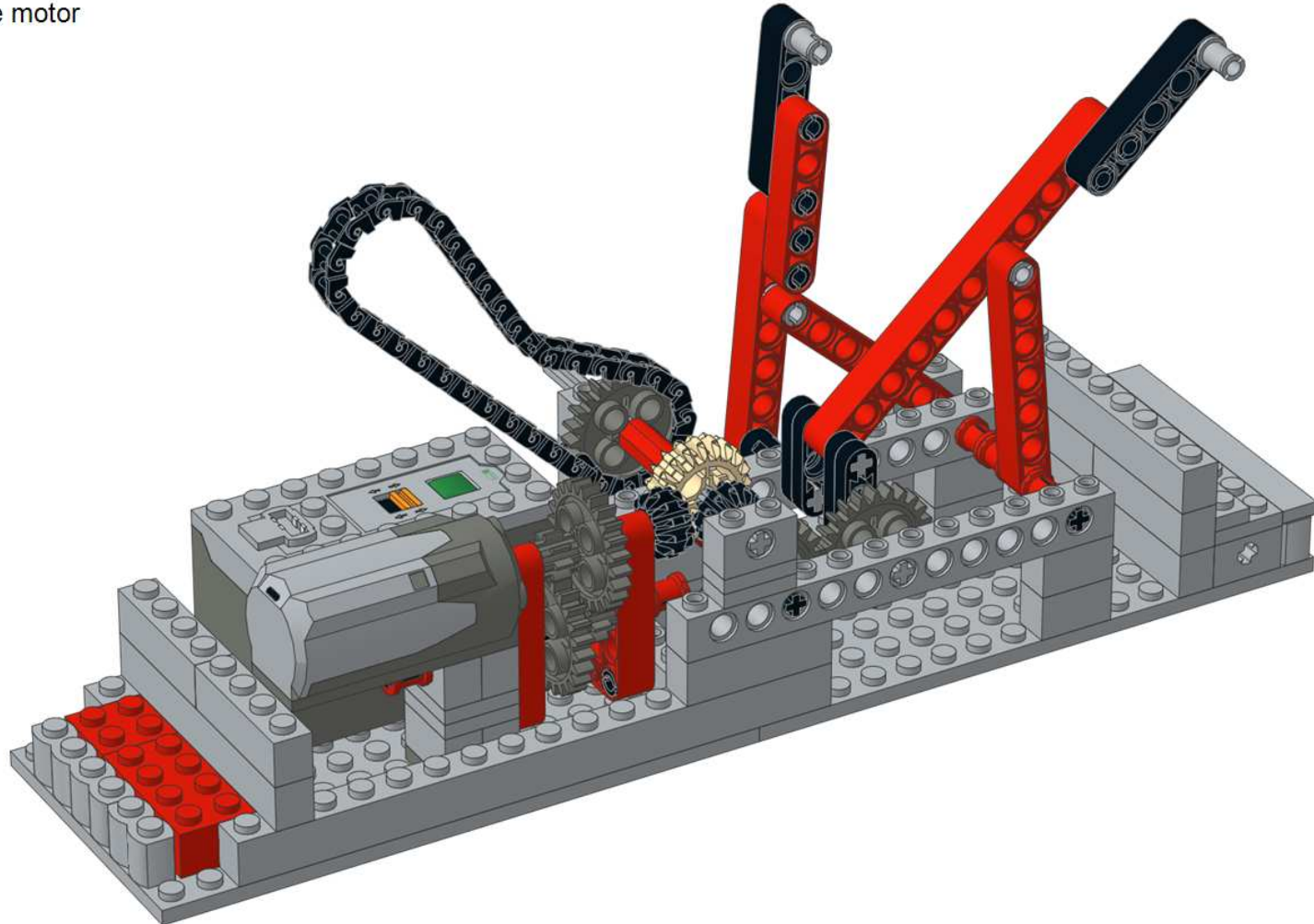

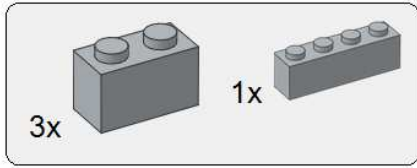

22

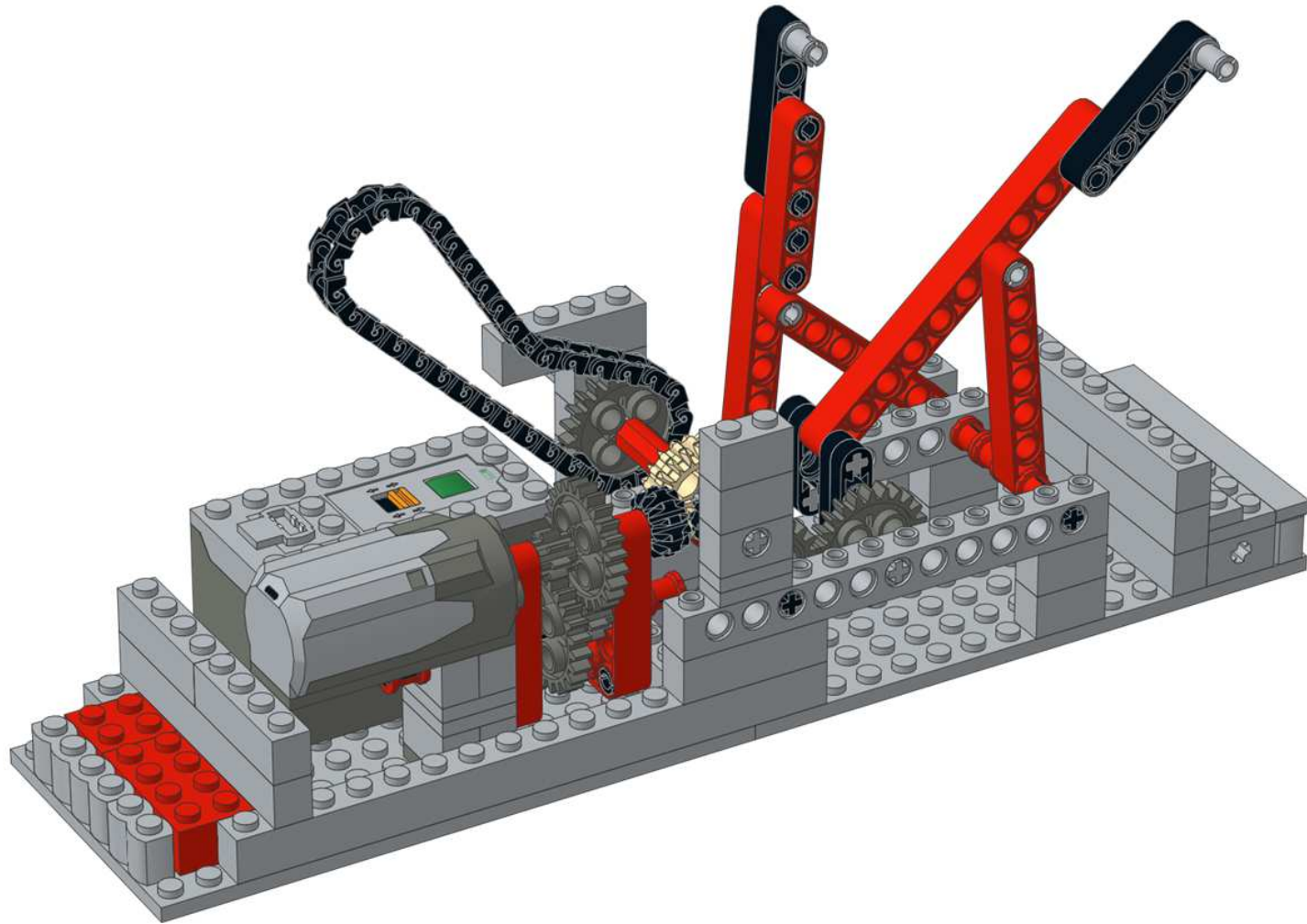

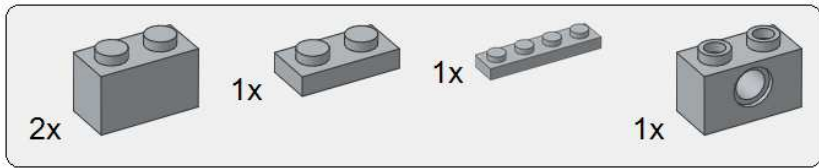

23

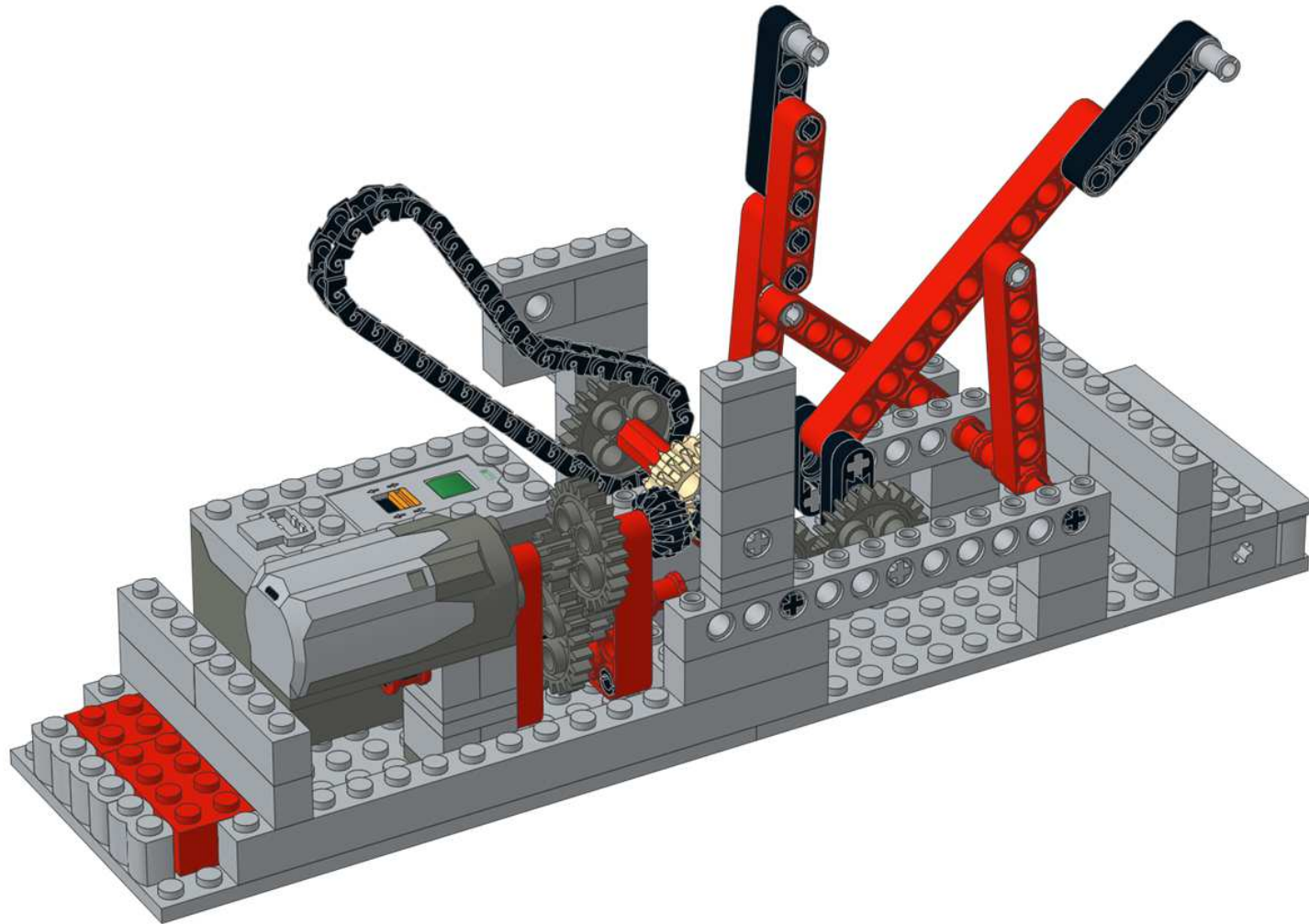

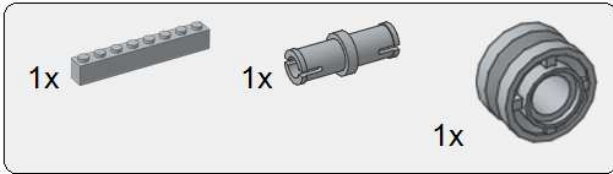

24

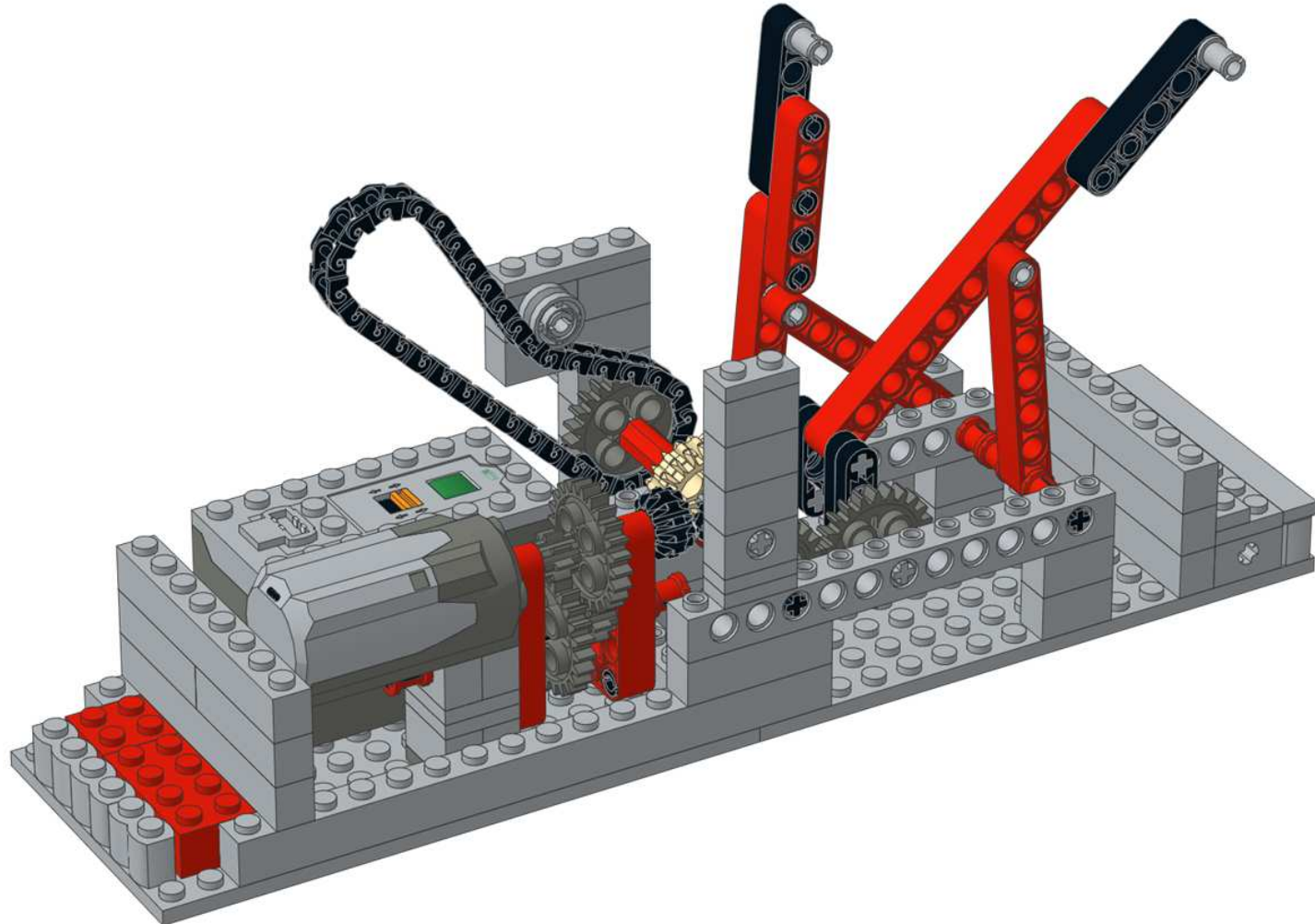

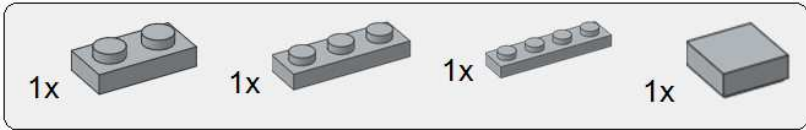

25

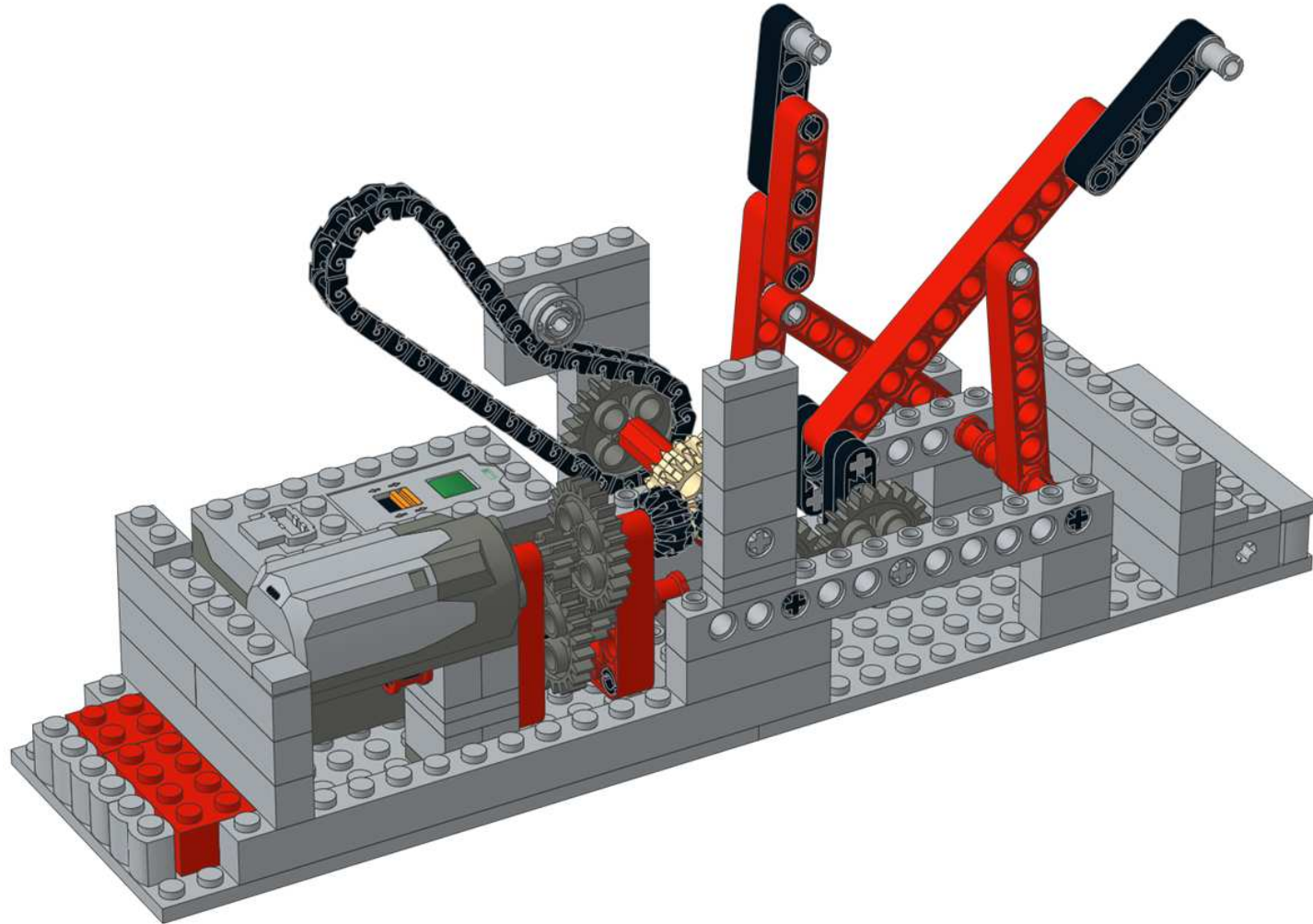

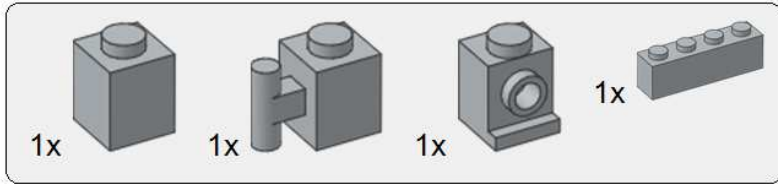

26

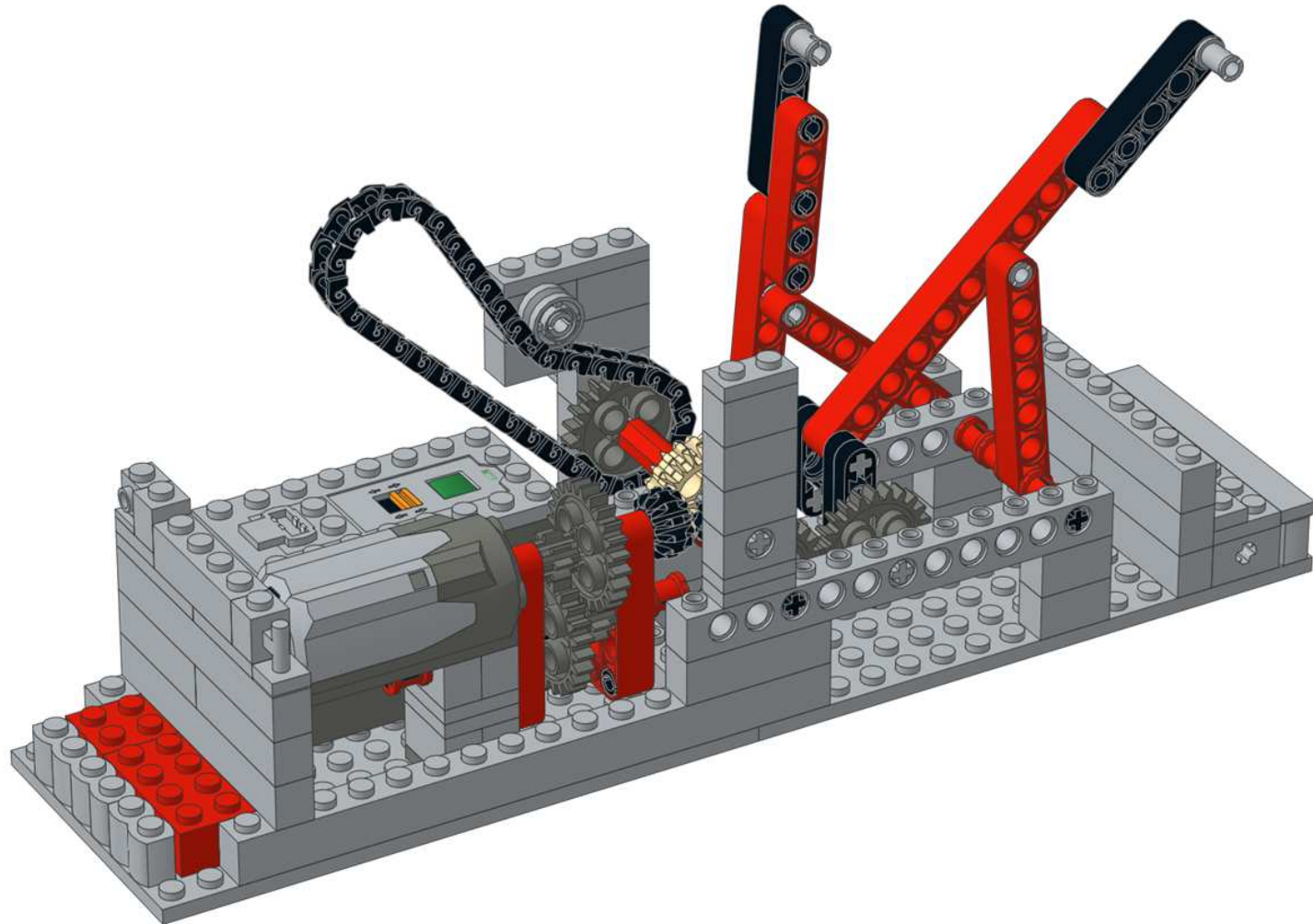

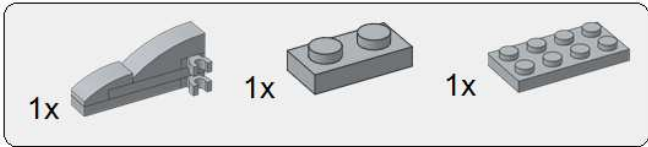

27

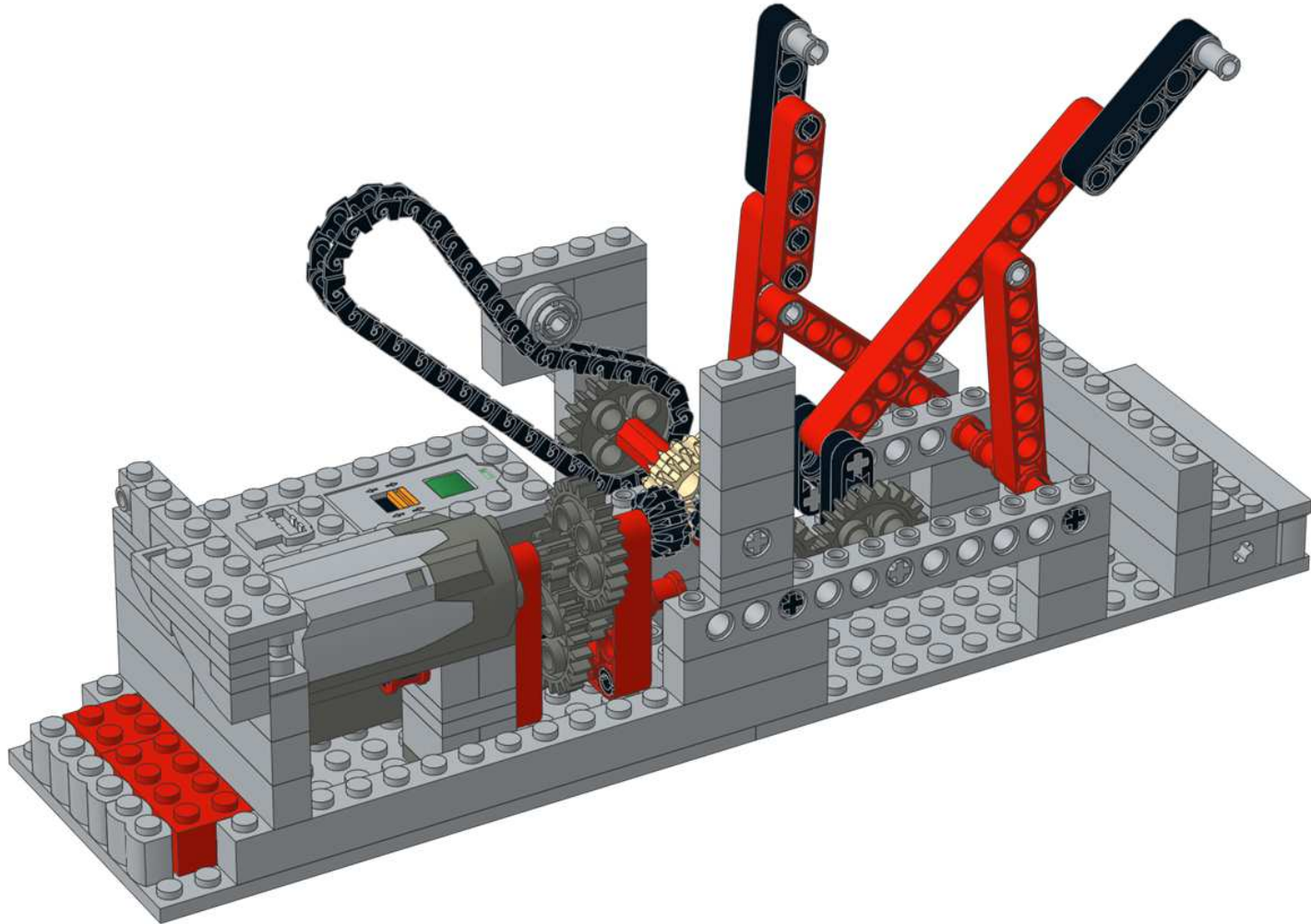

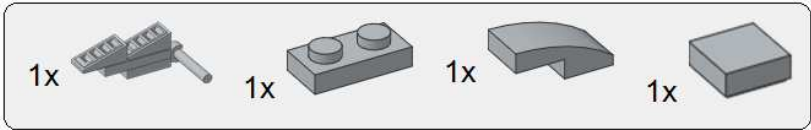

28

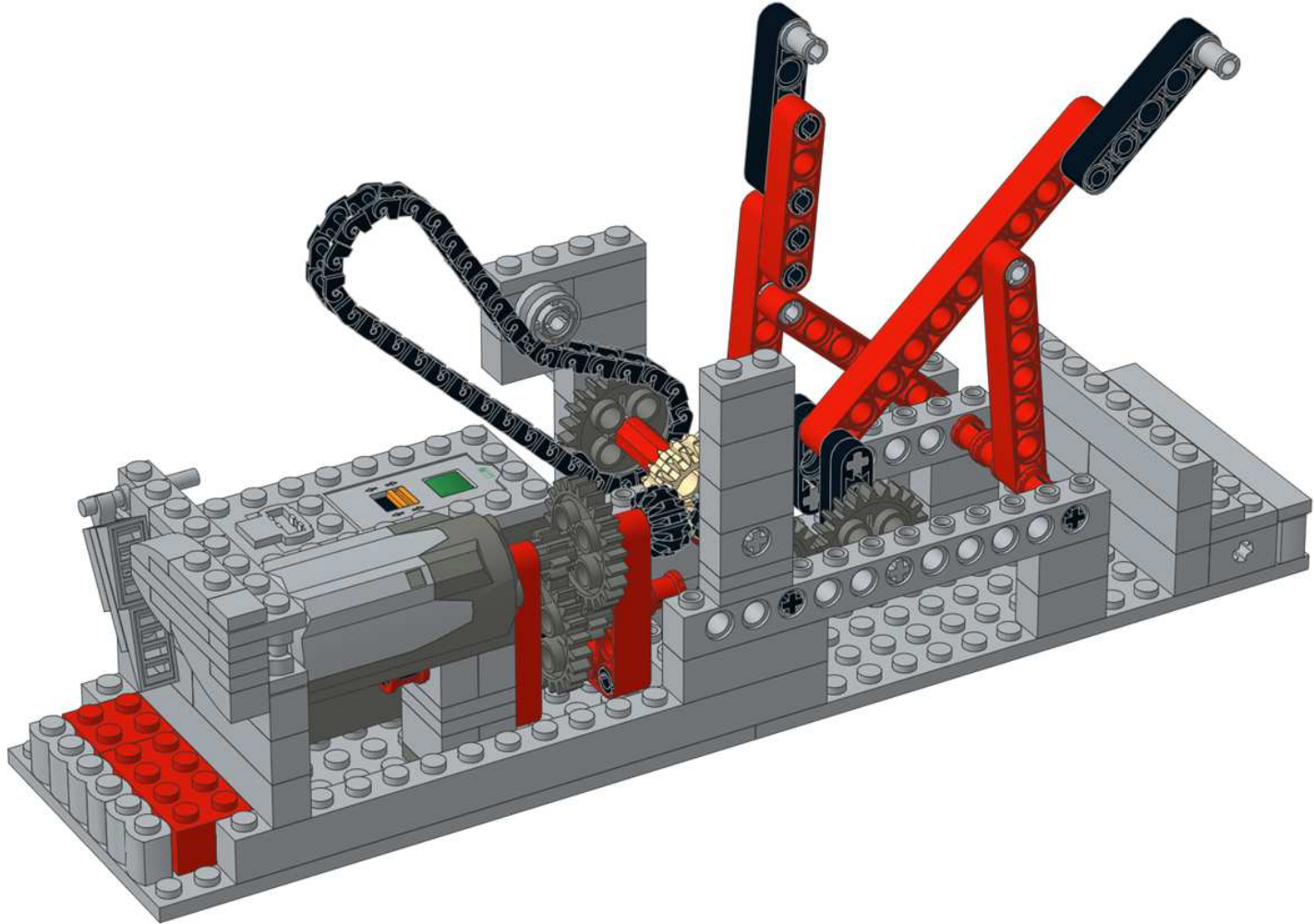

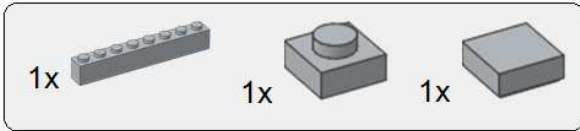

29

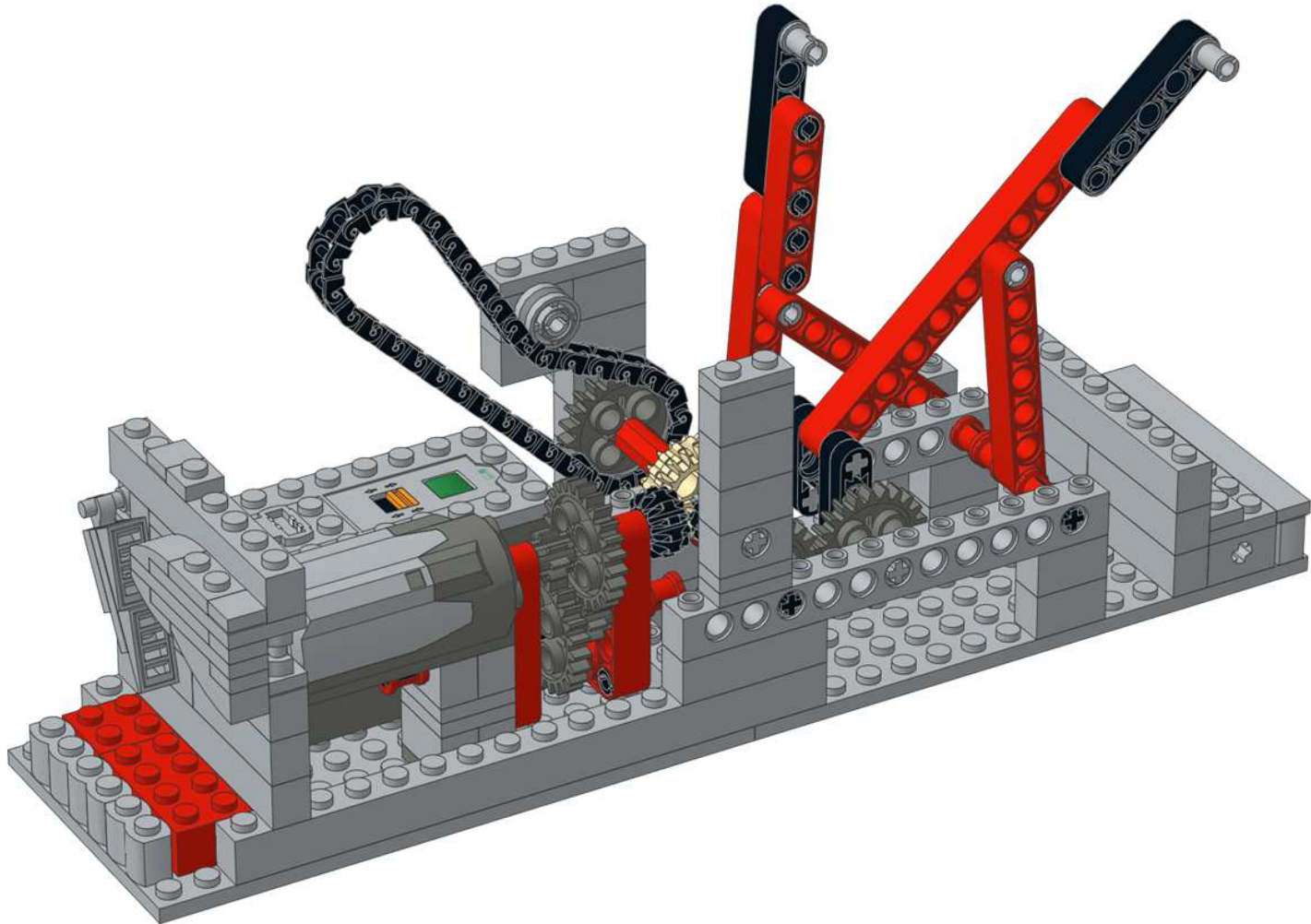

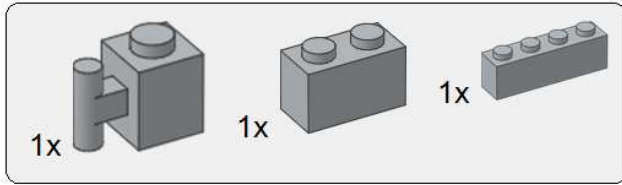

30

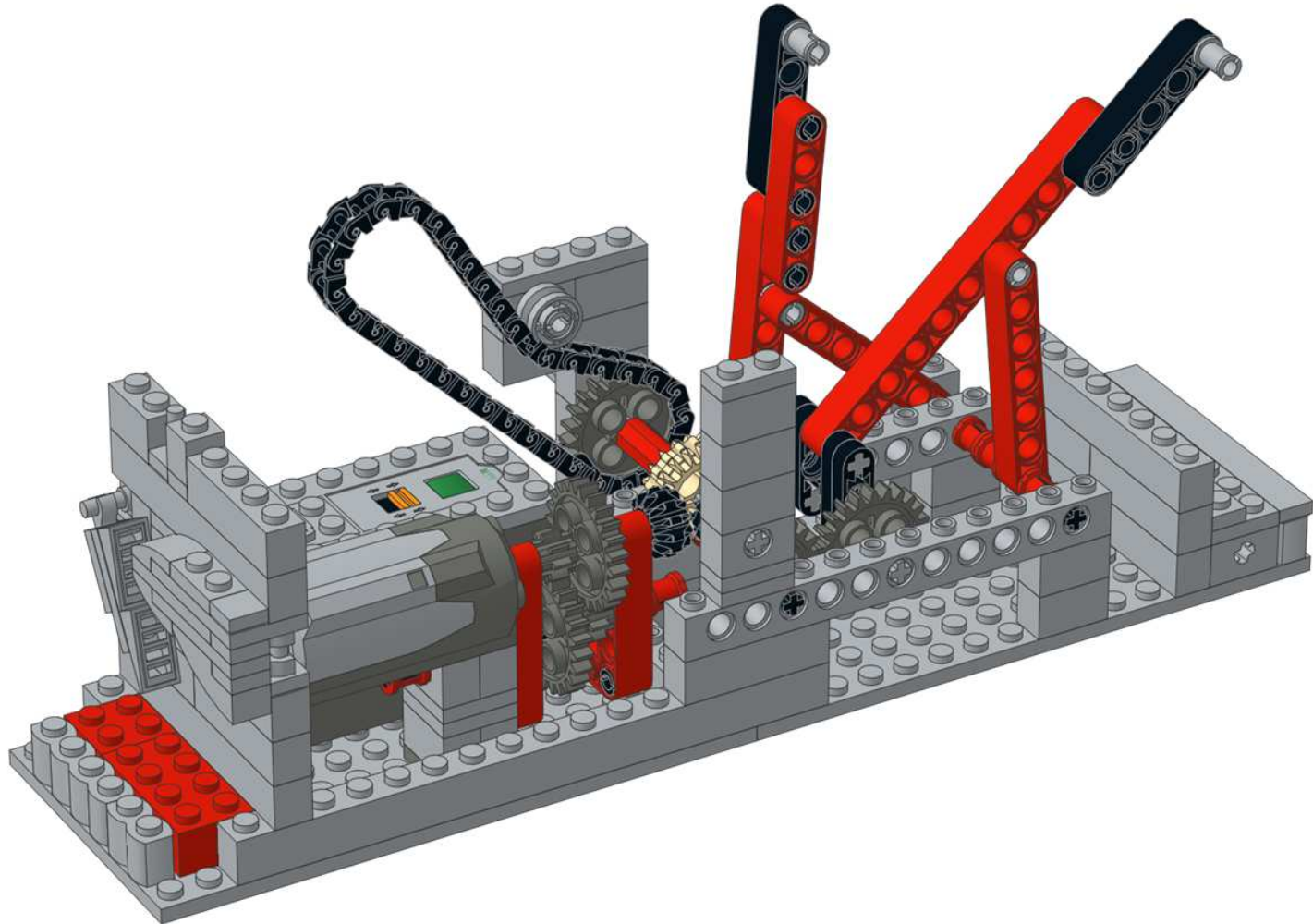

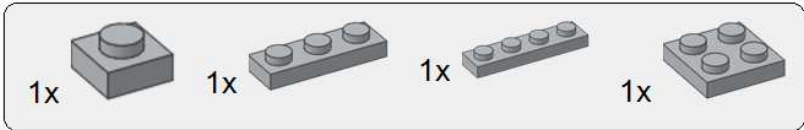

31

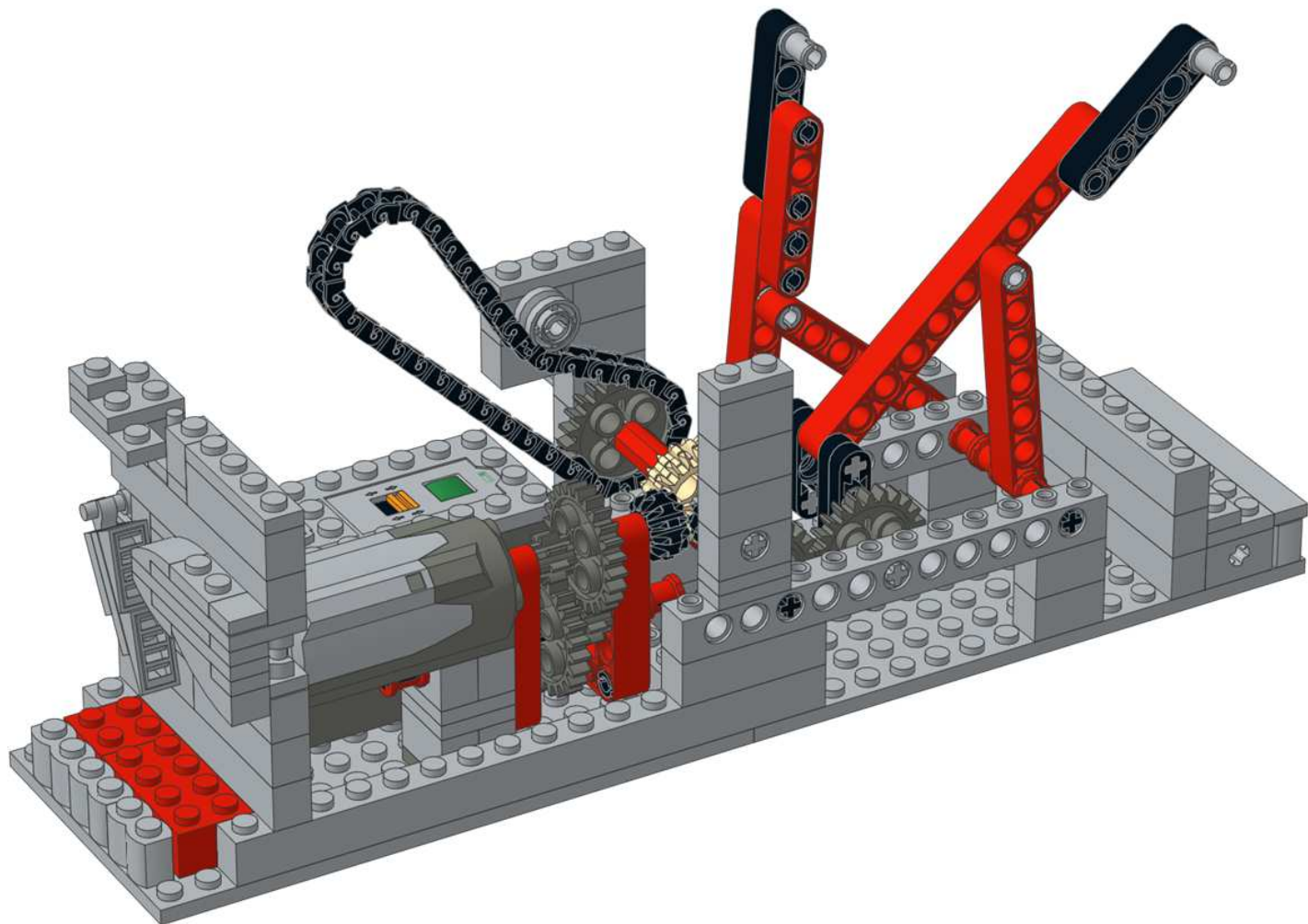



32

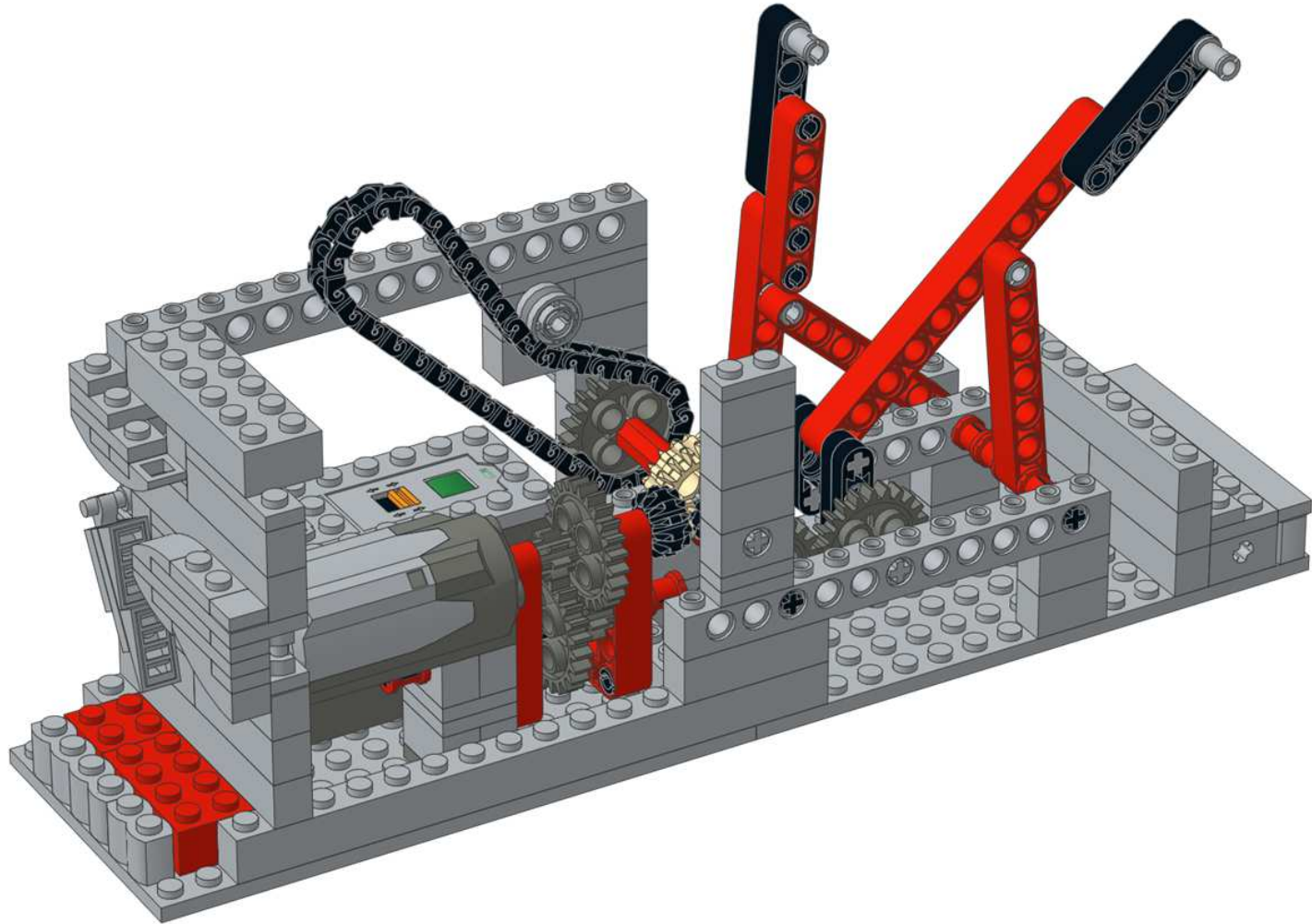

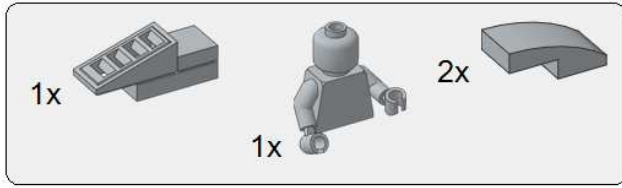

33

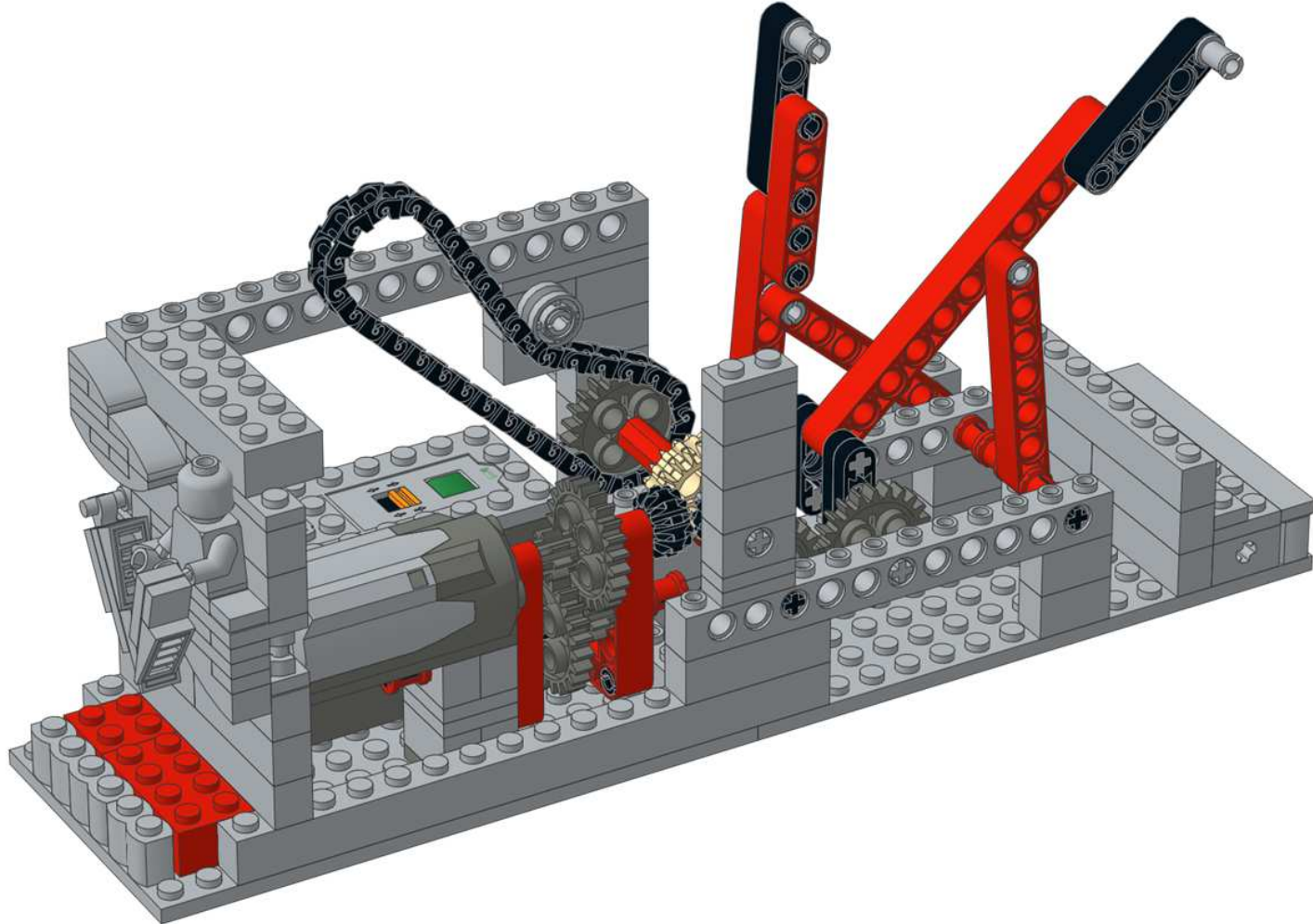



34

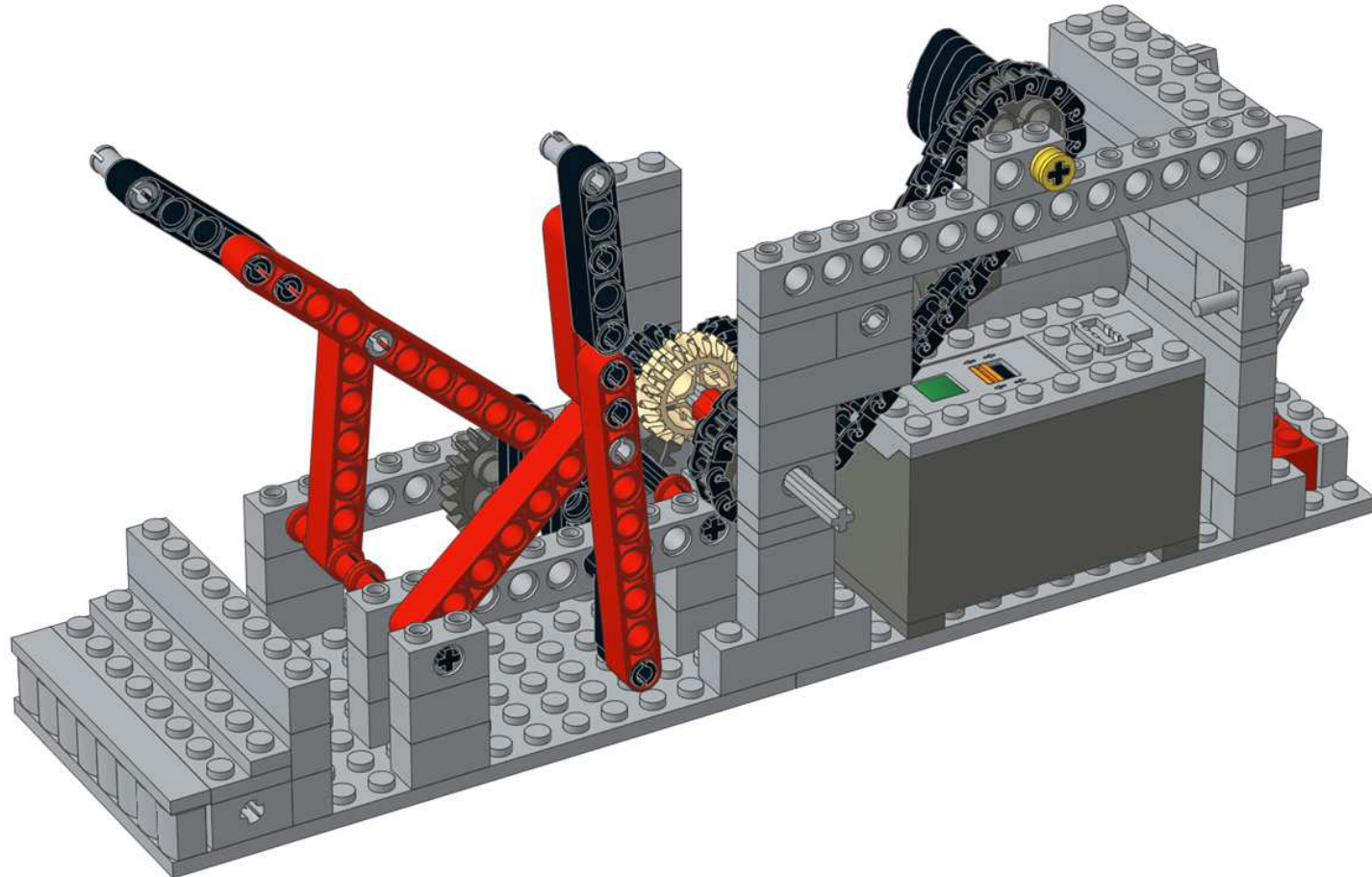

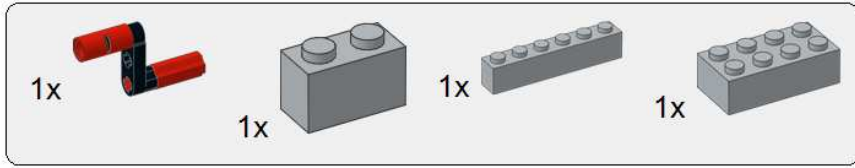

35

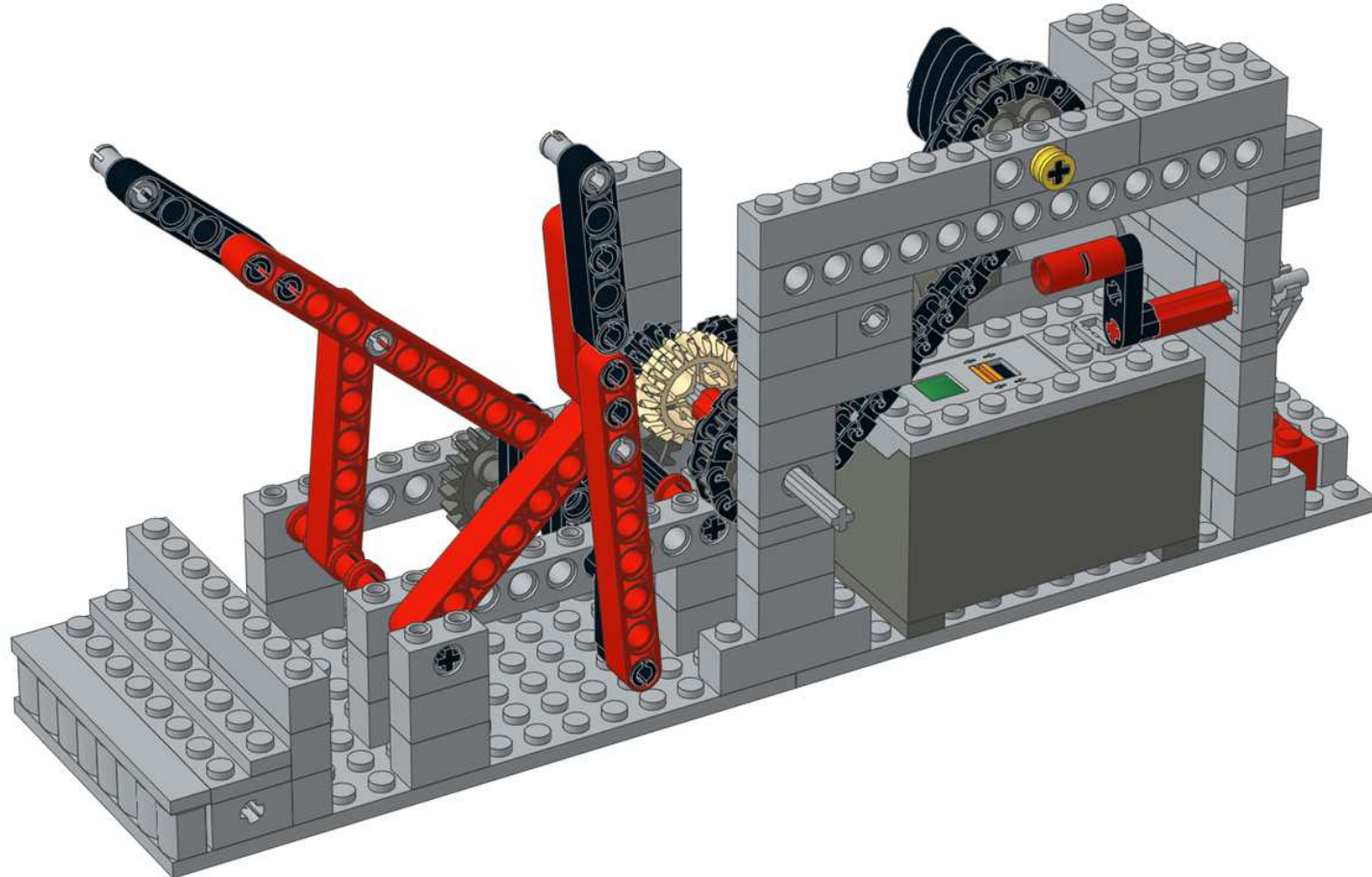

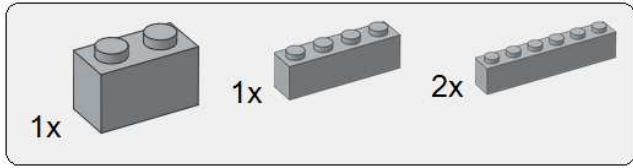

36

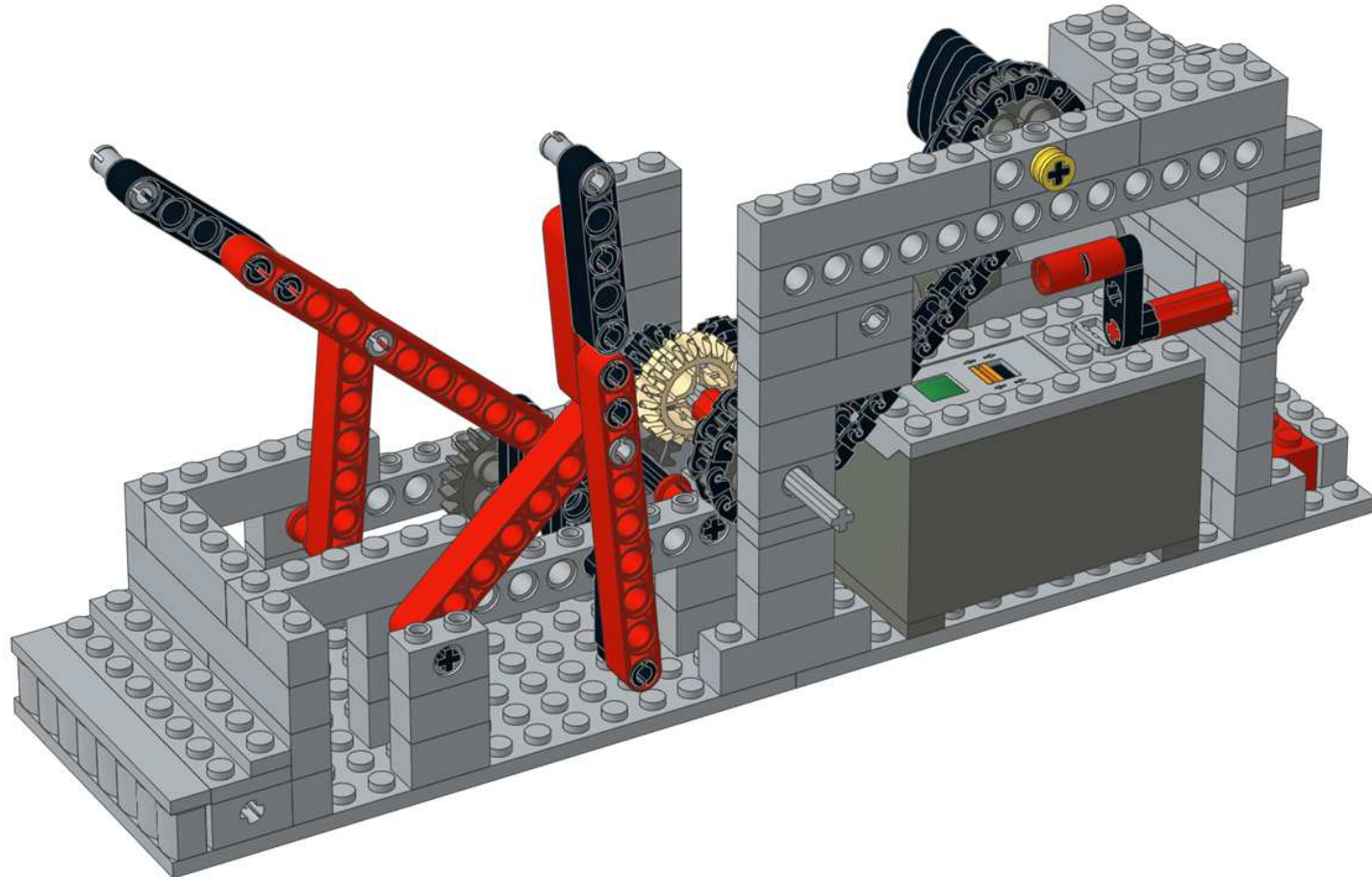

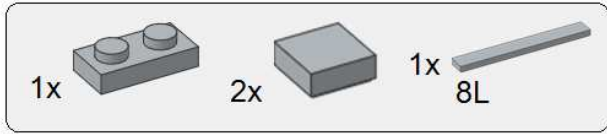

37

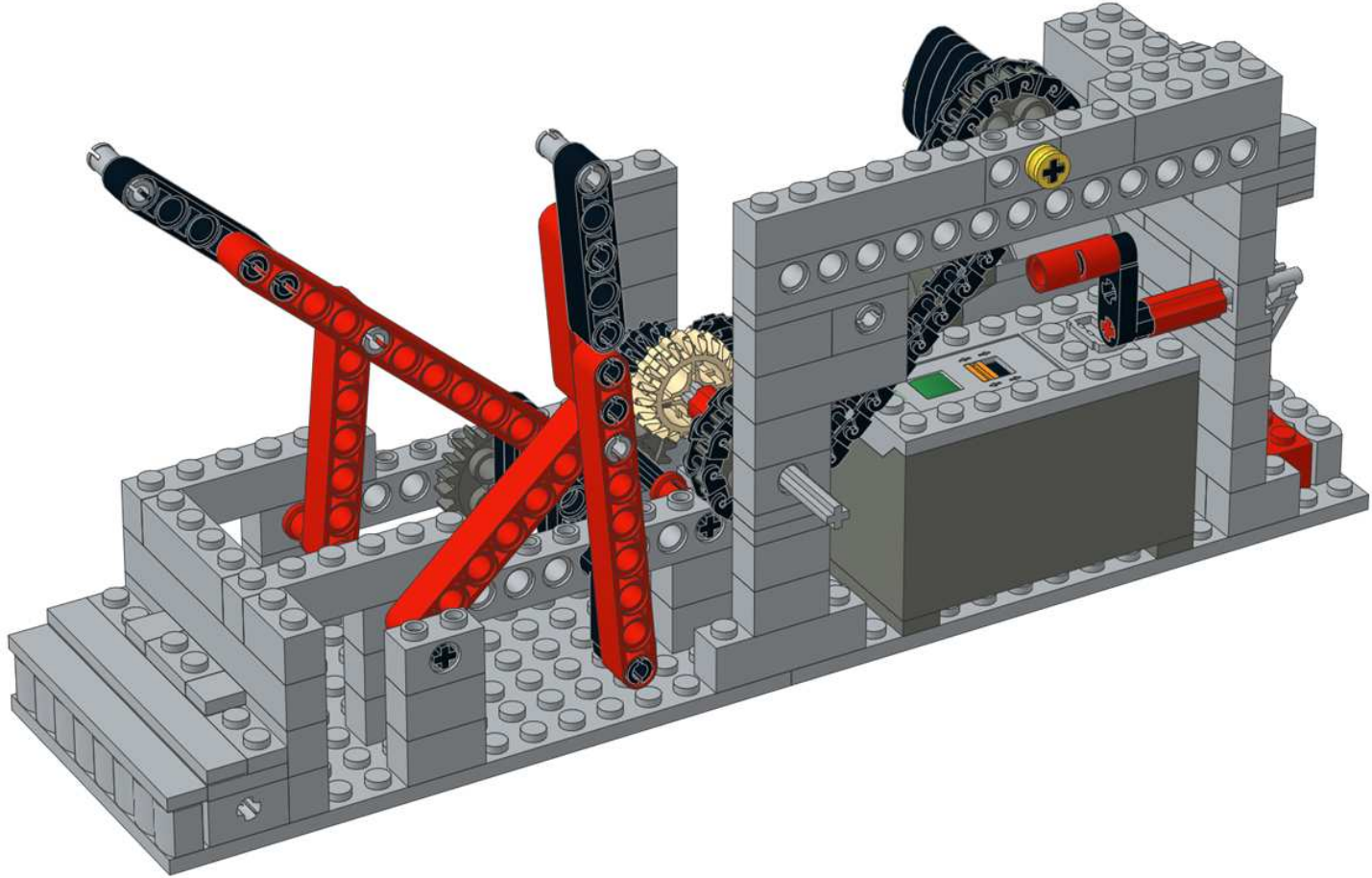

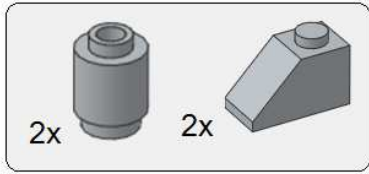

38

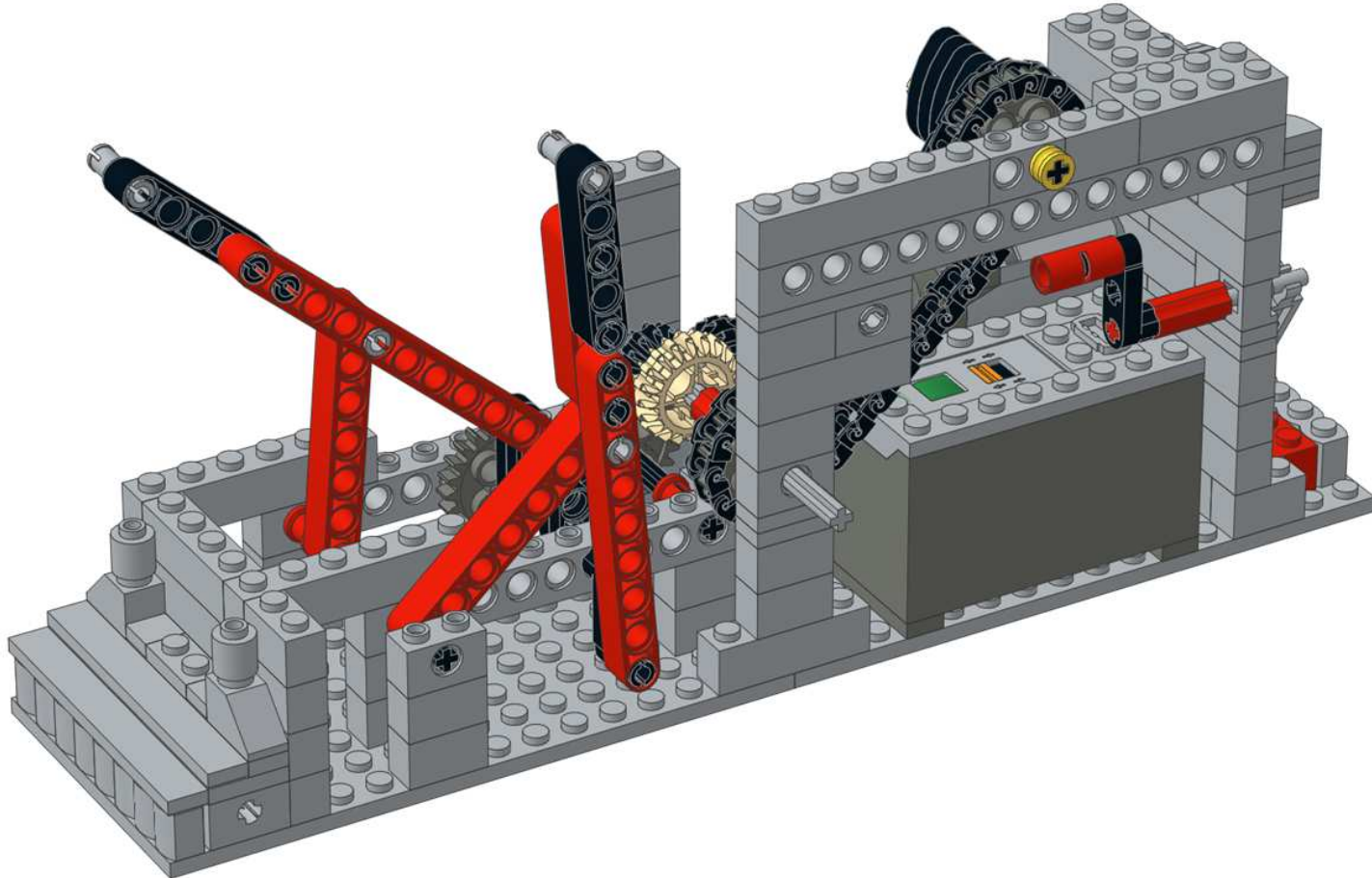

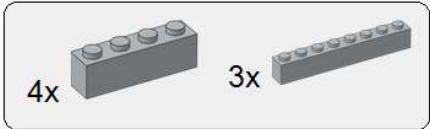

39

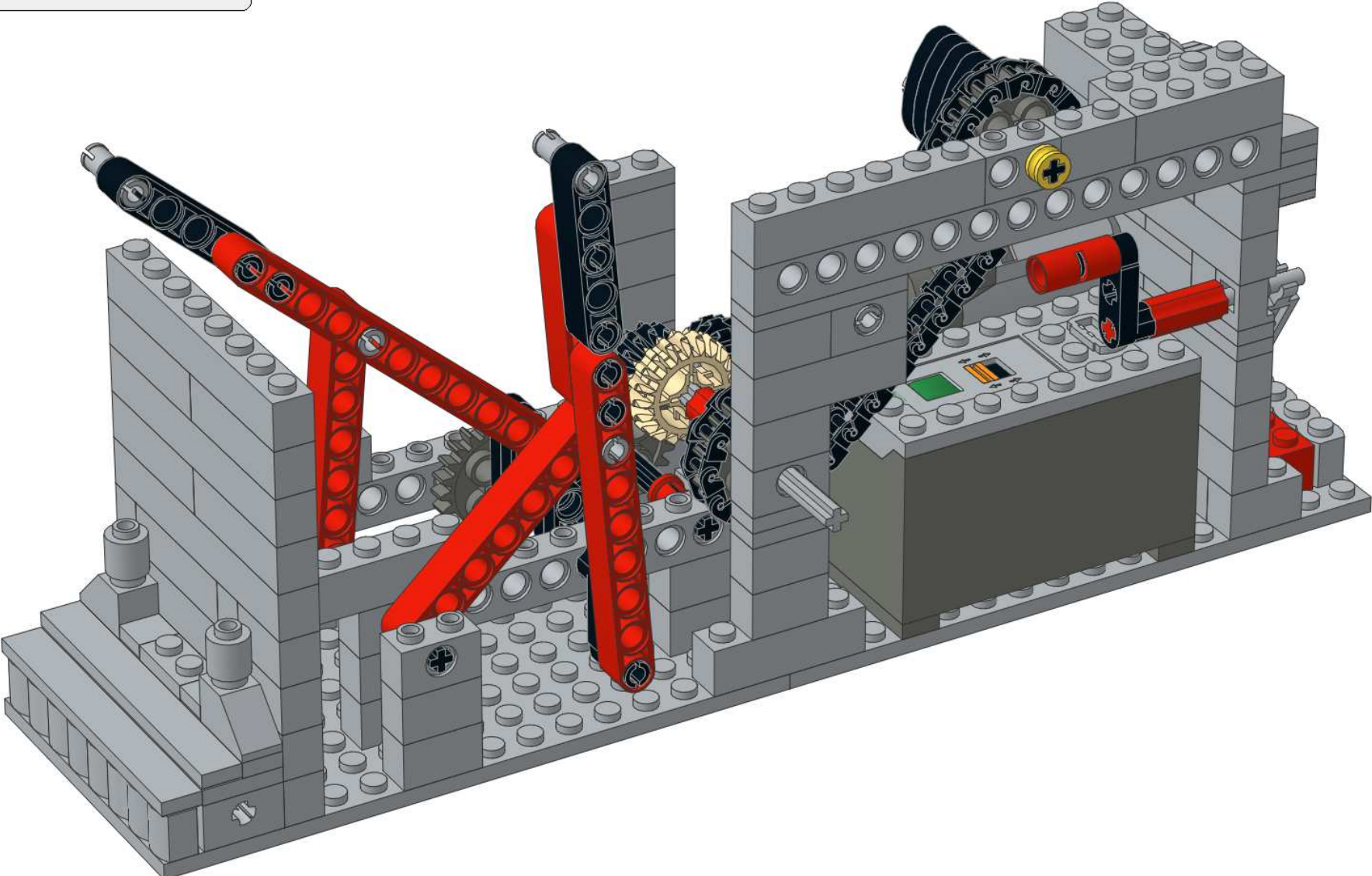

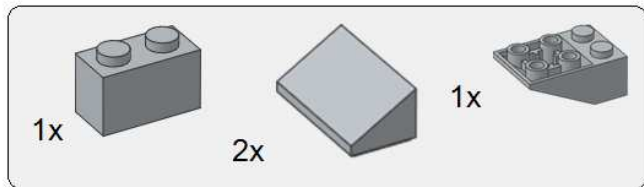

40

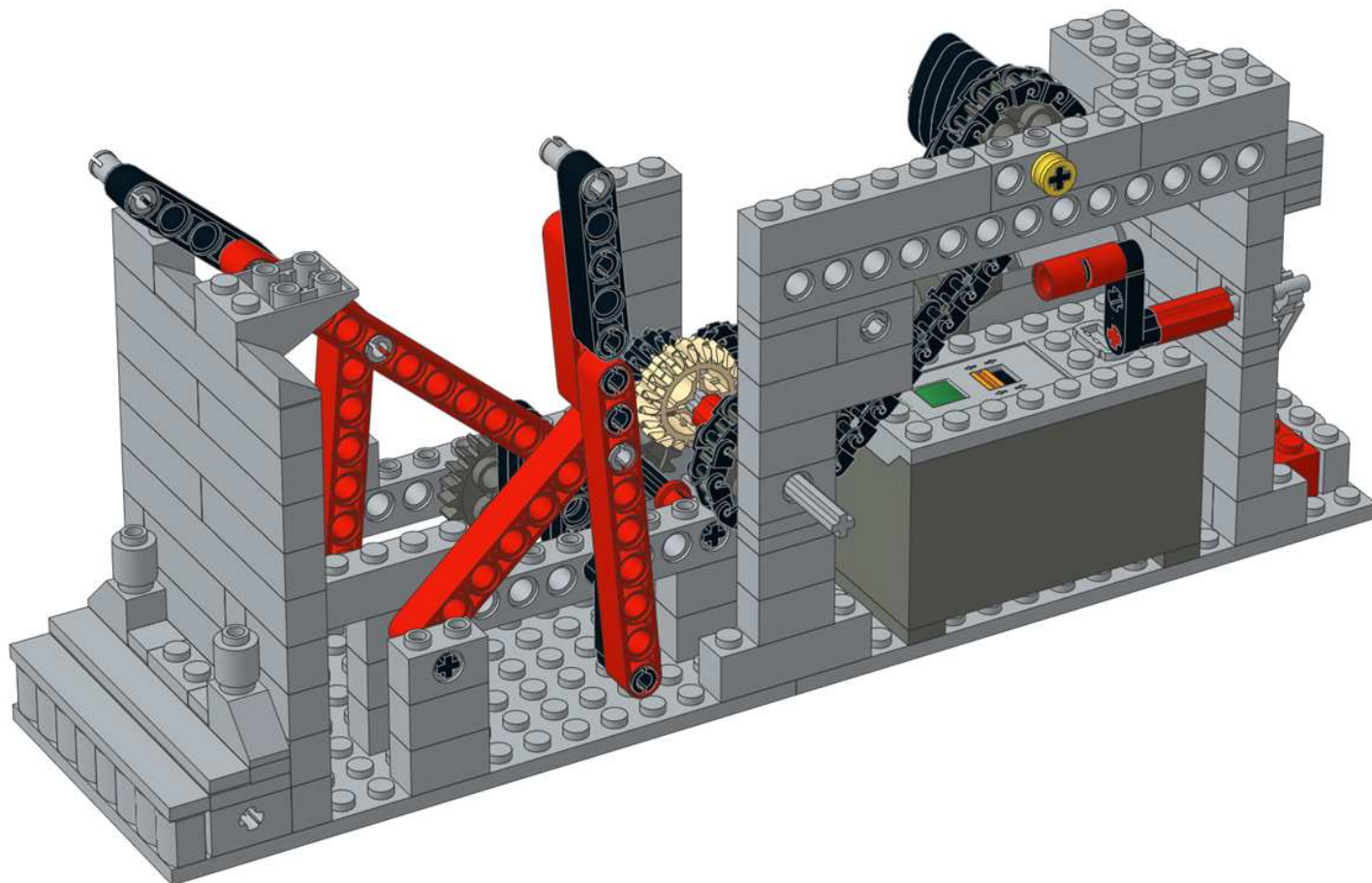

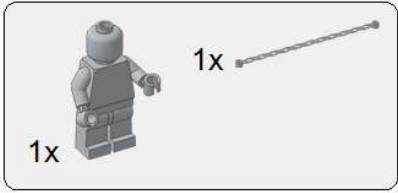

41

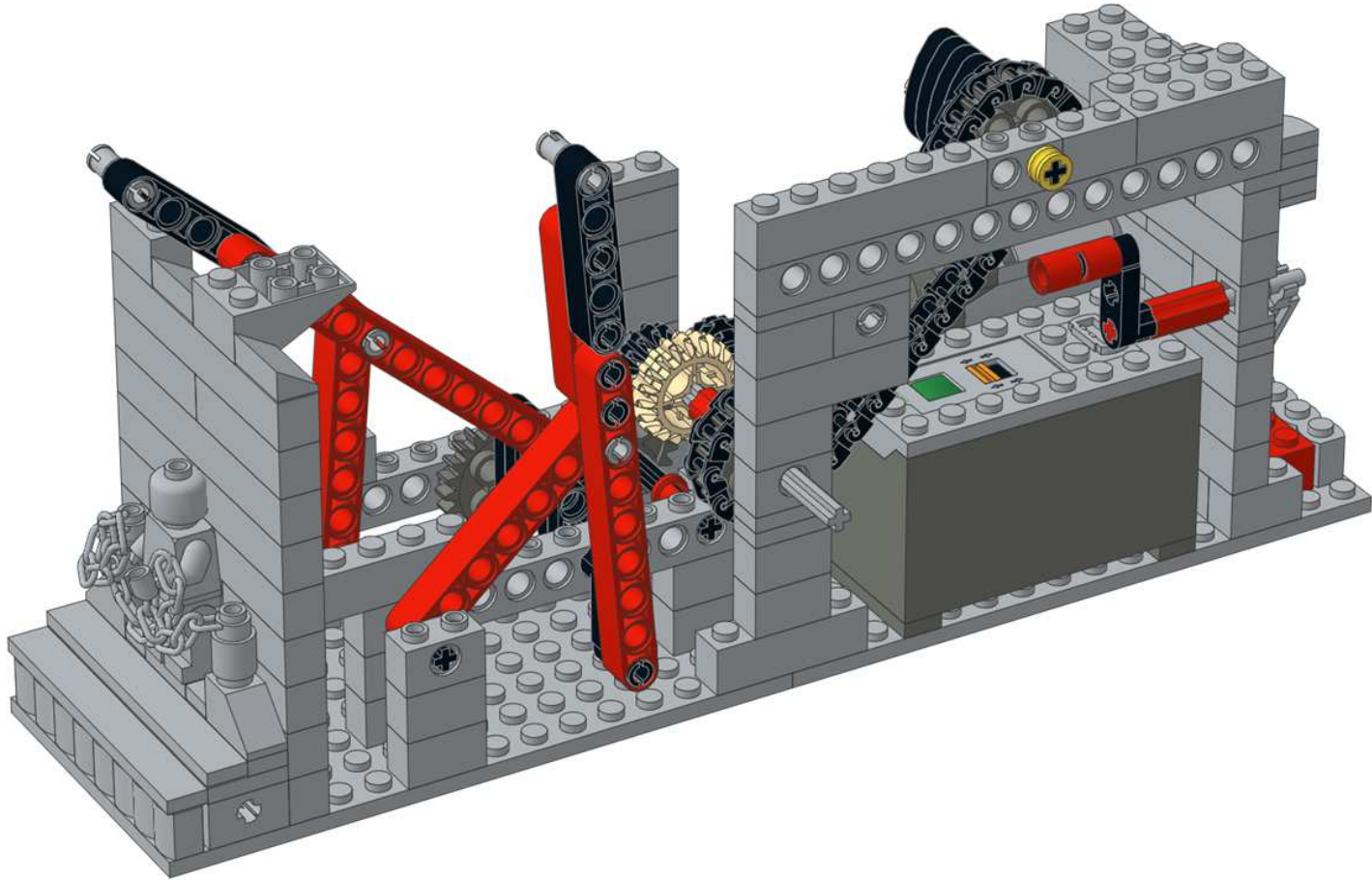

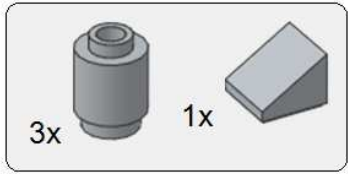

42

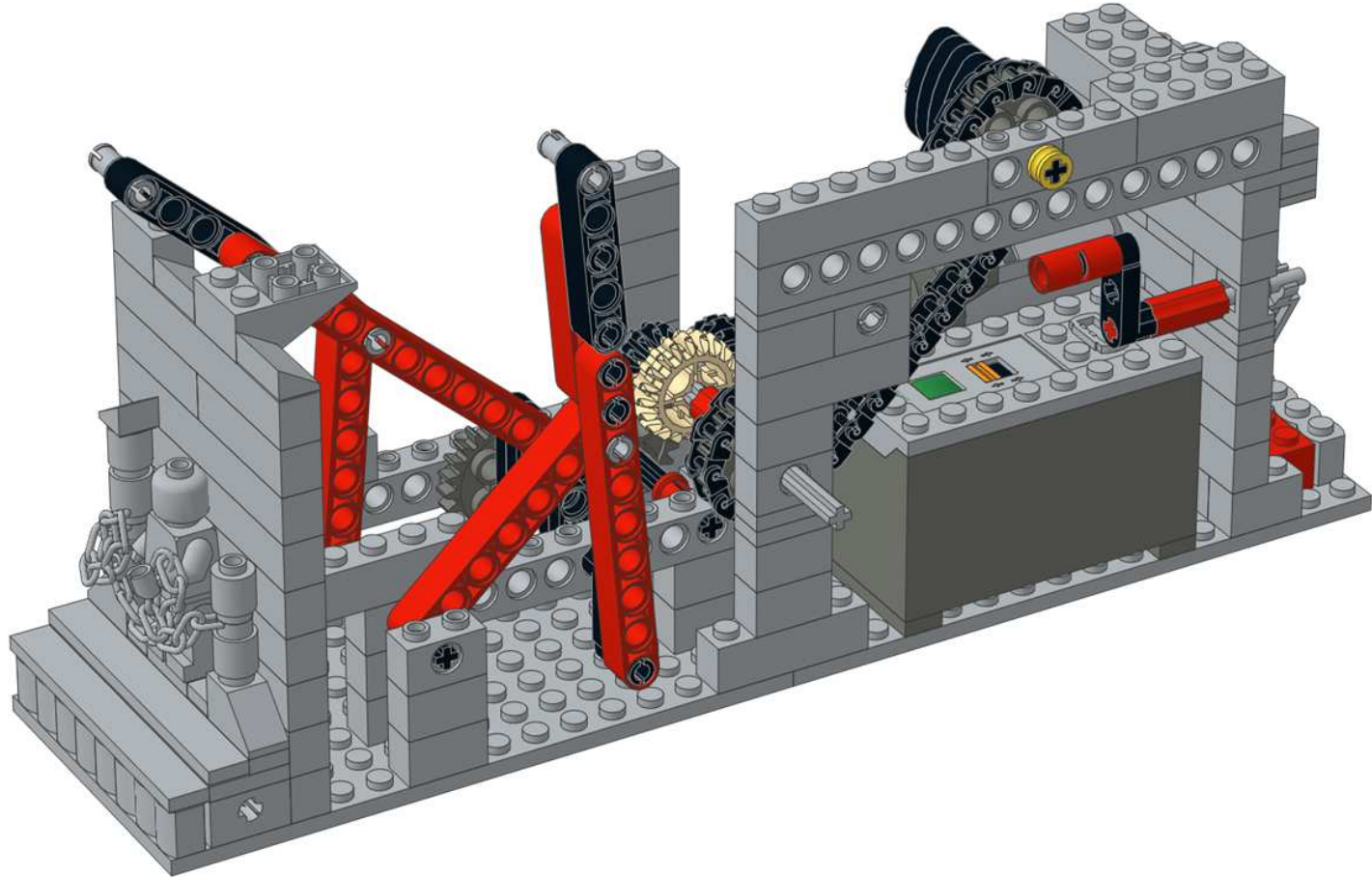

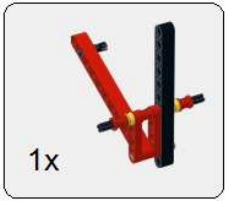

43

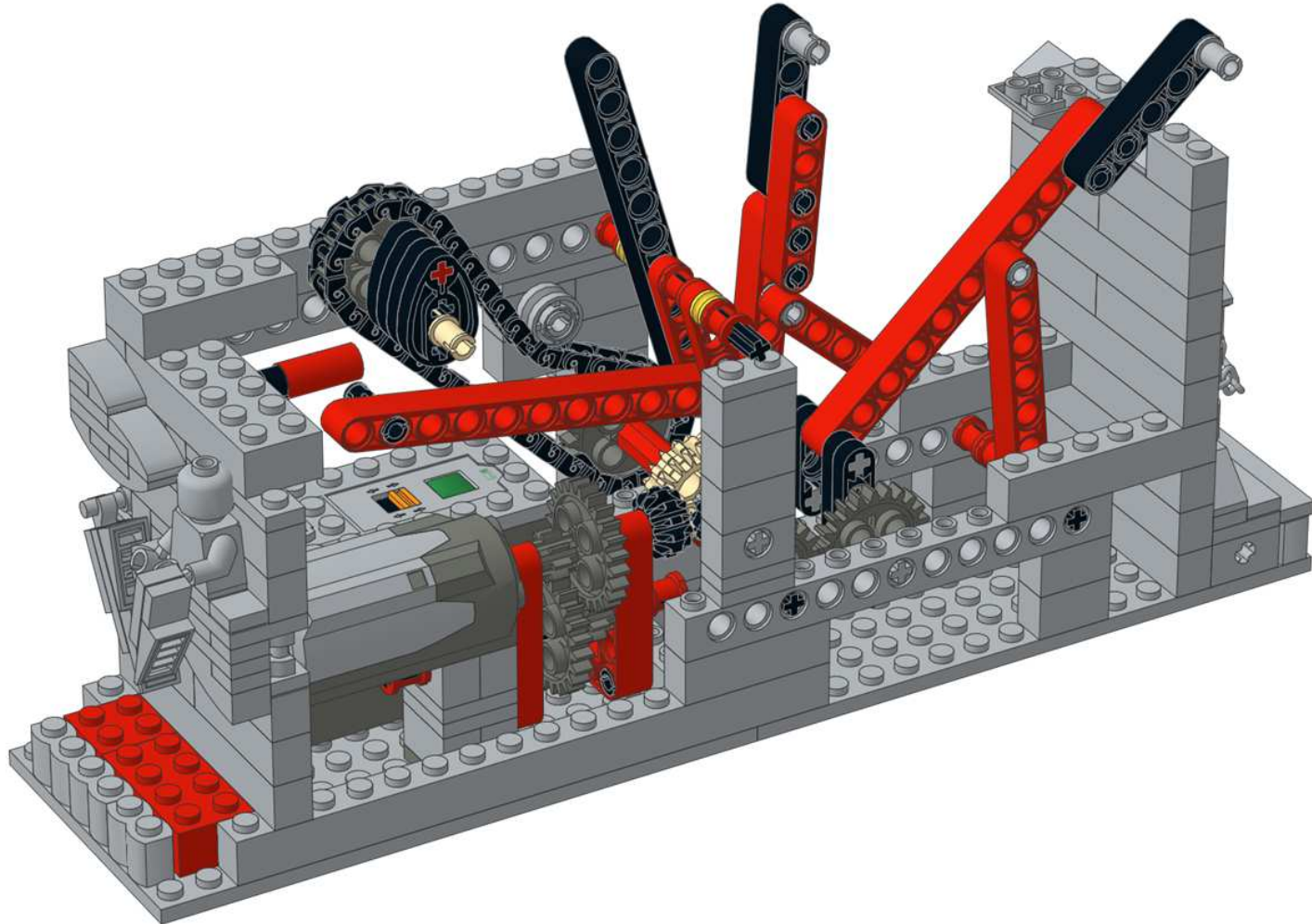

1x 

1x 

44

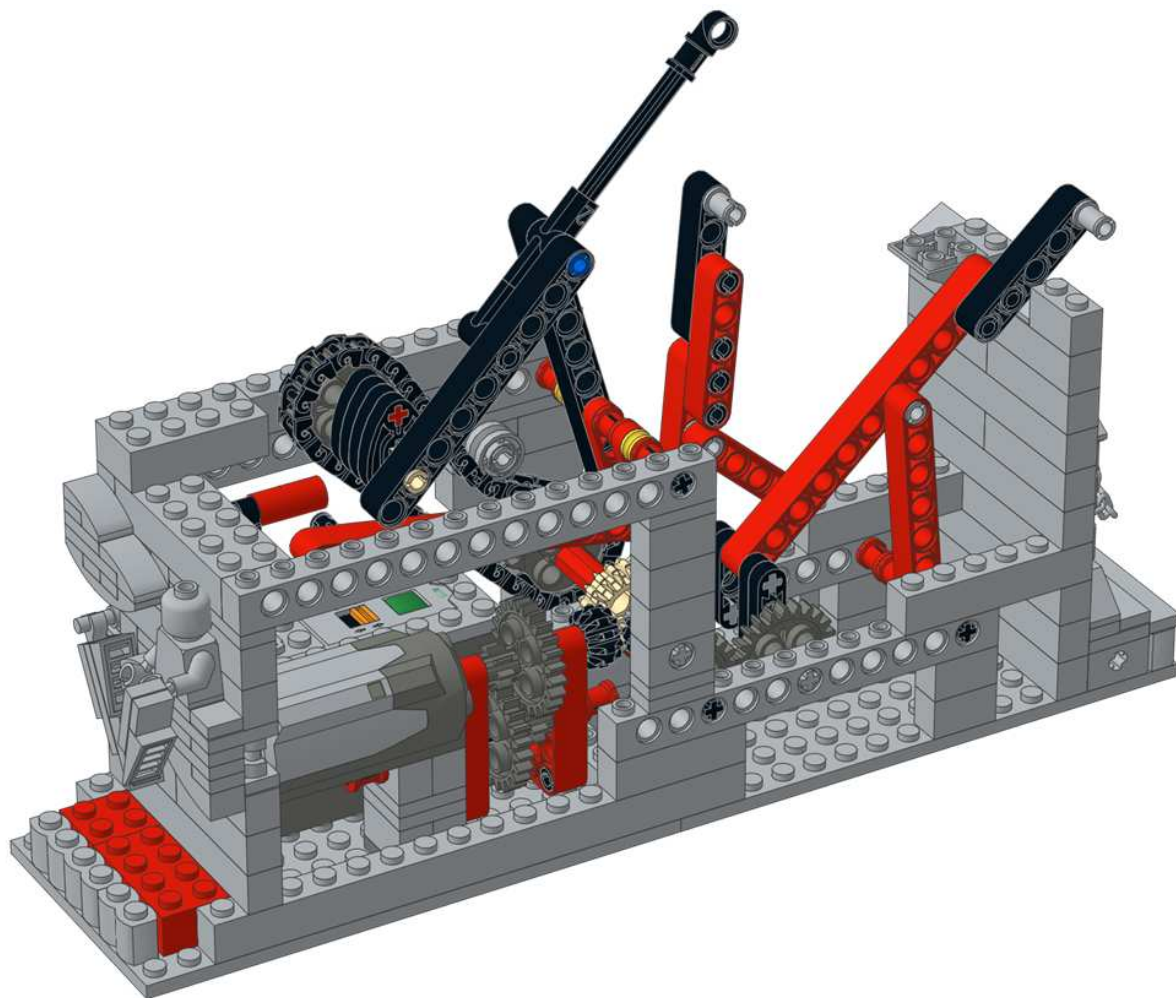

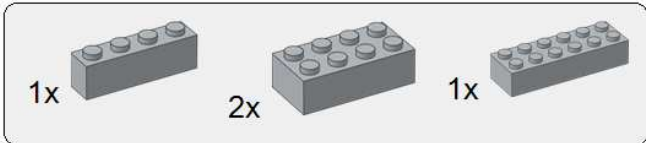

45

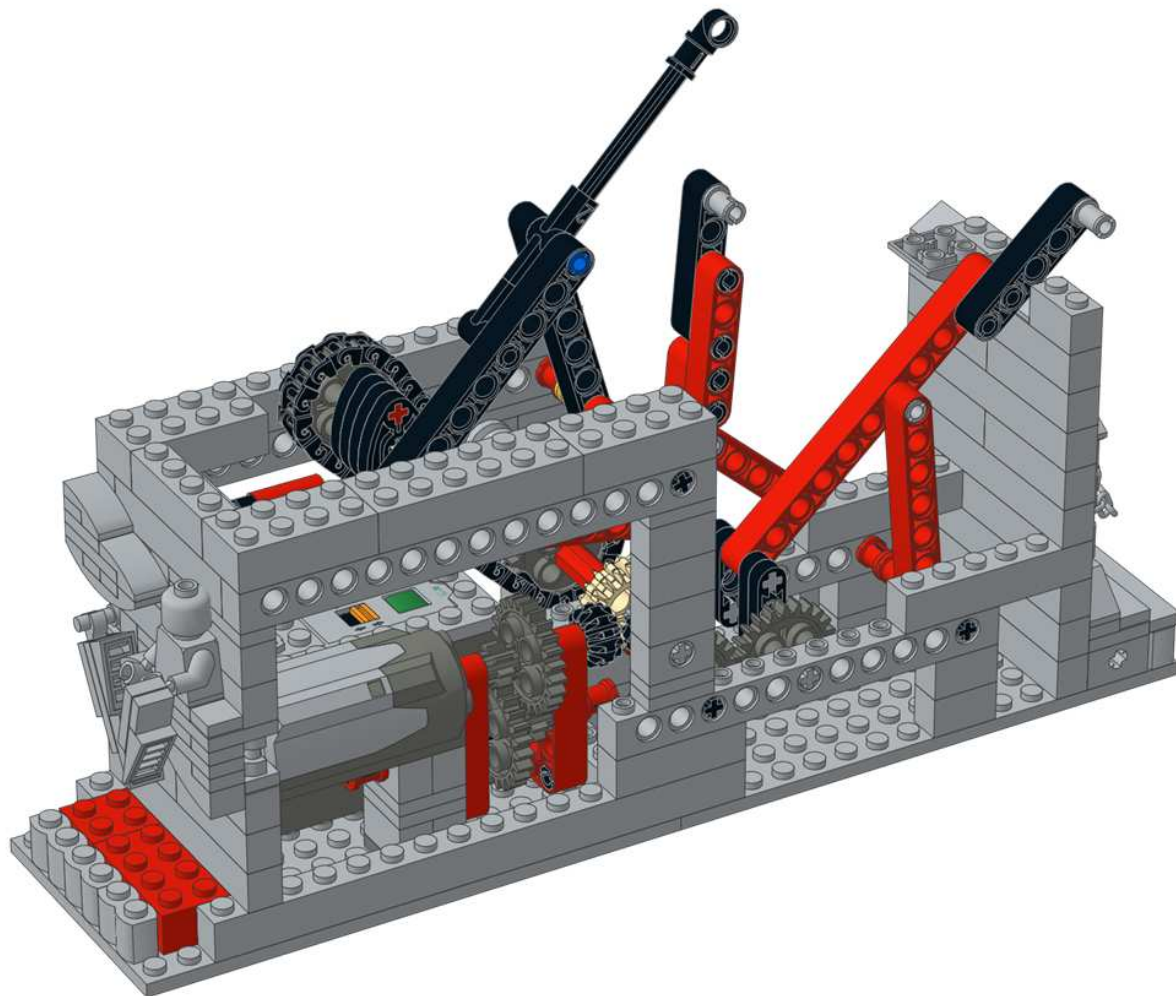



46

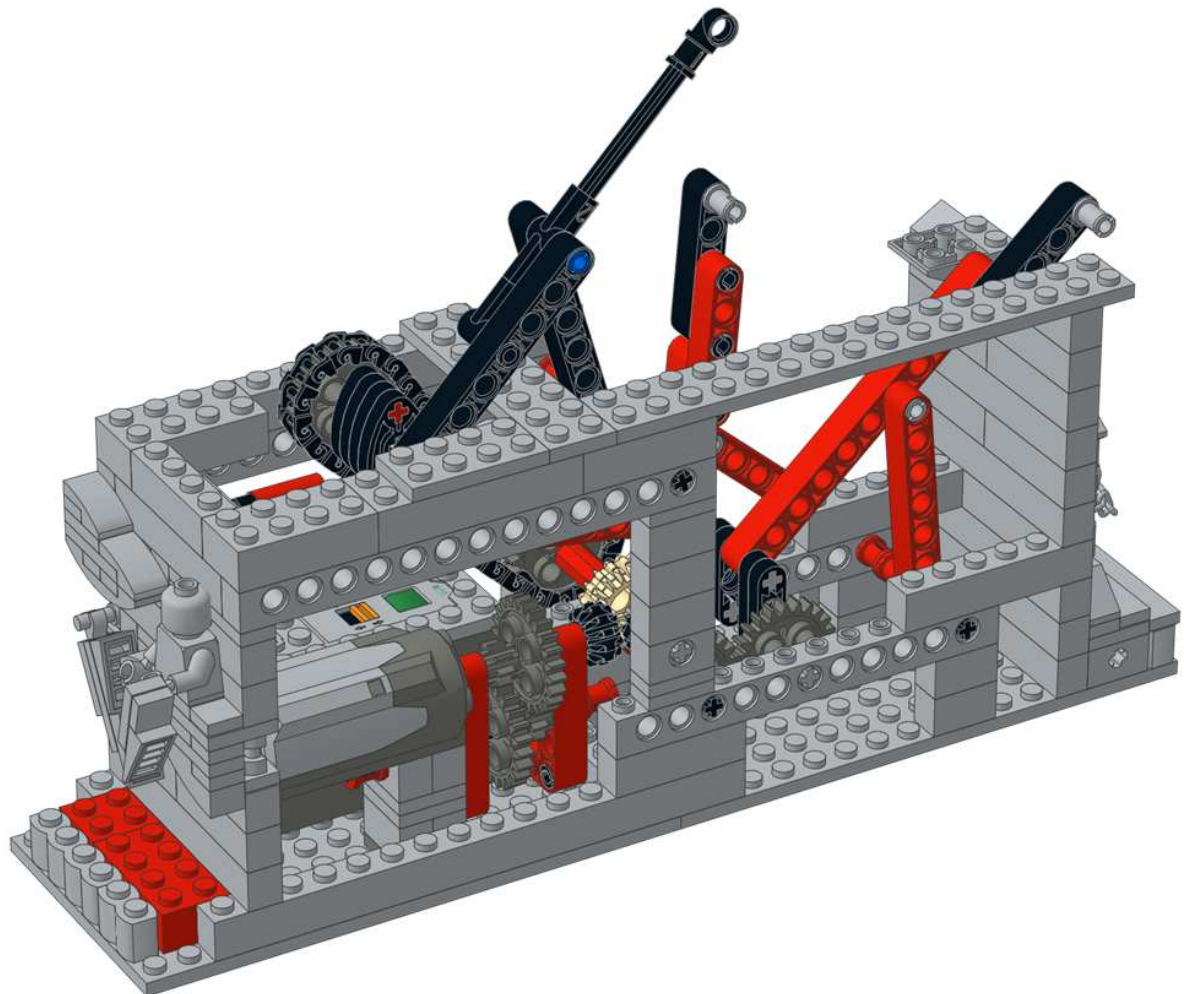



47

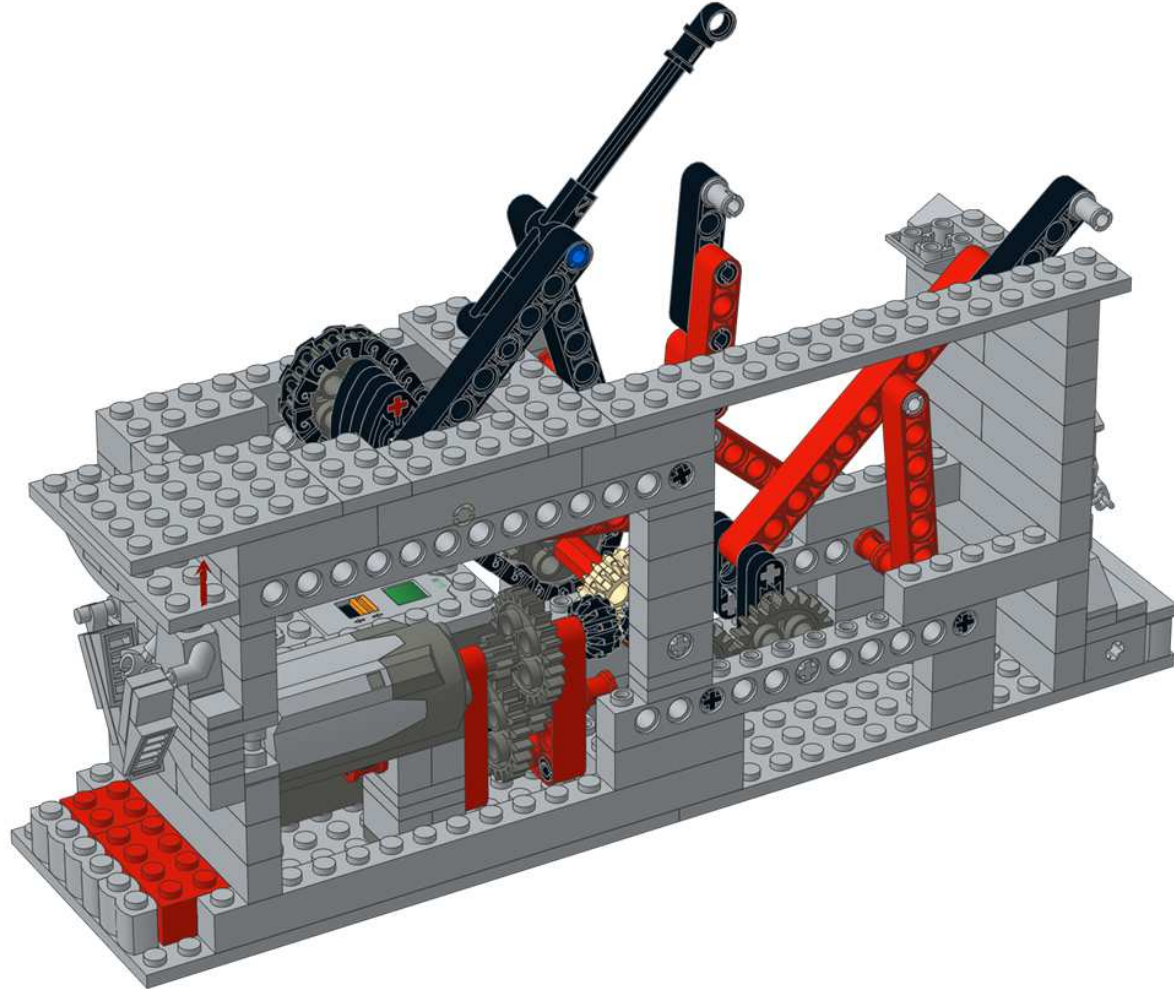

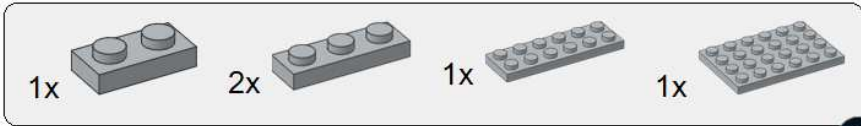

48

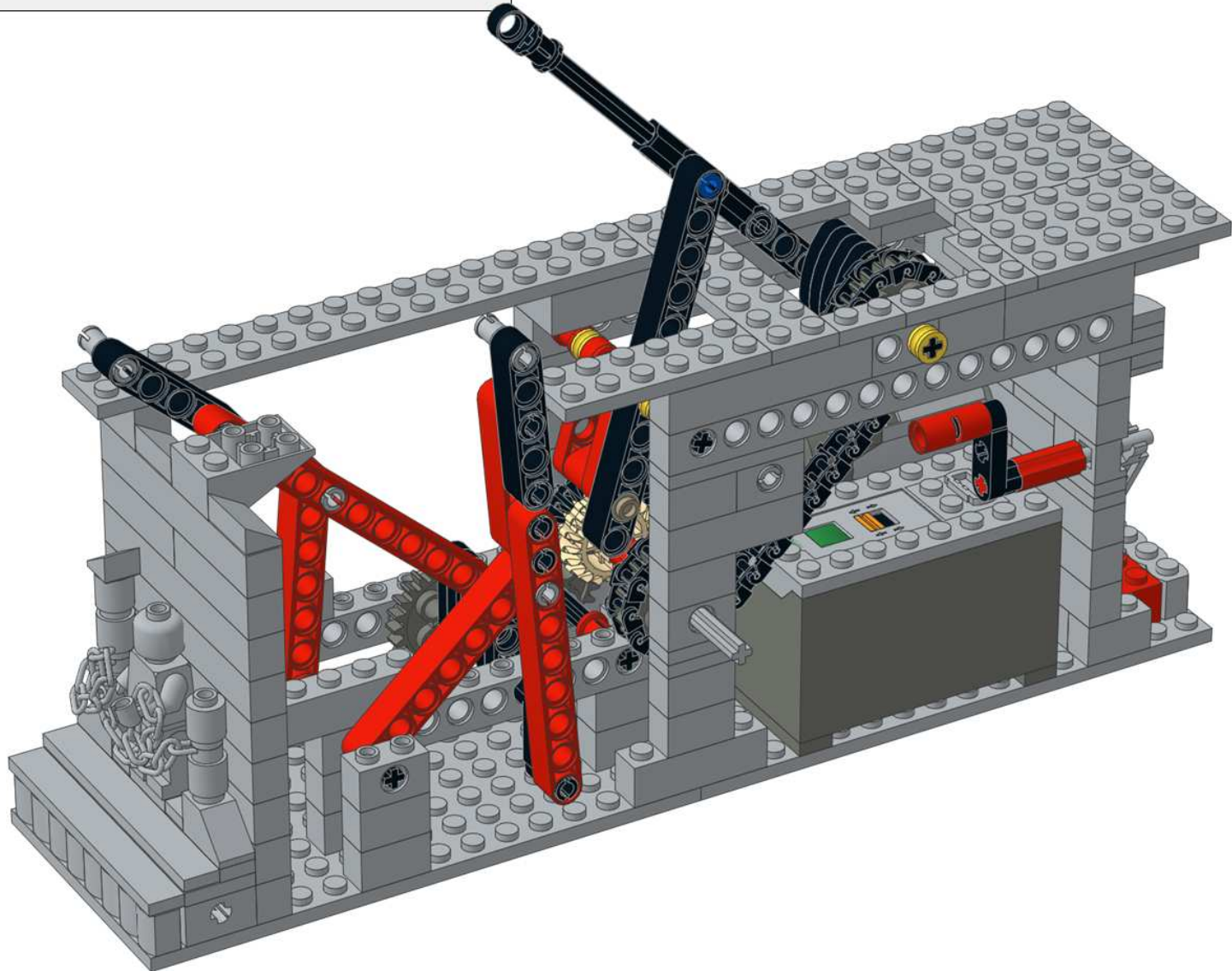



49

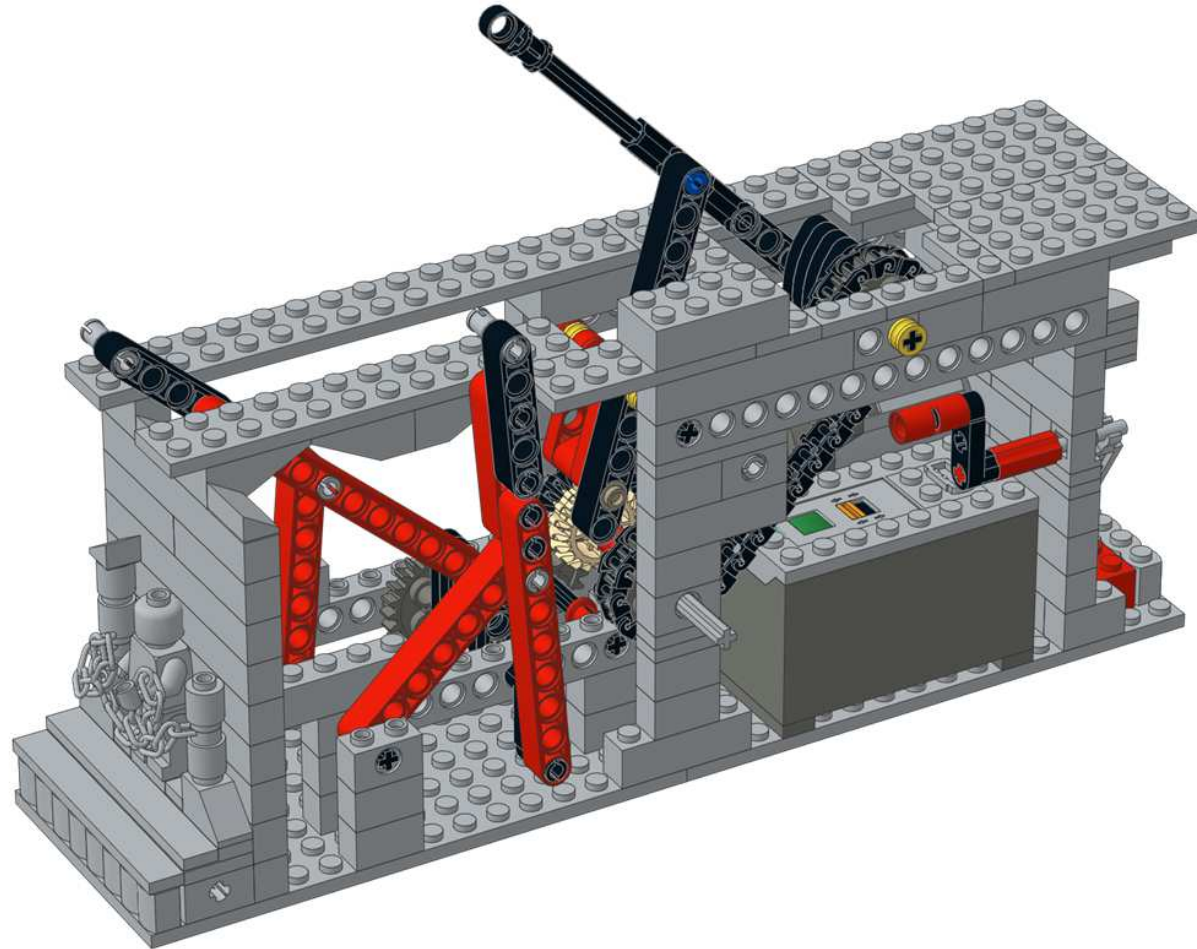

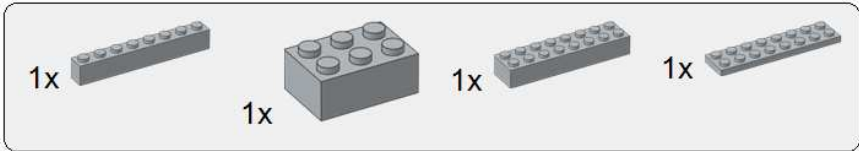

50

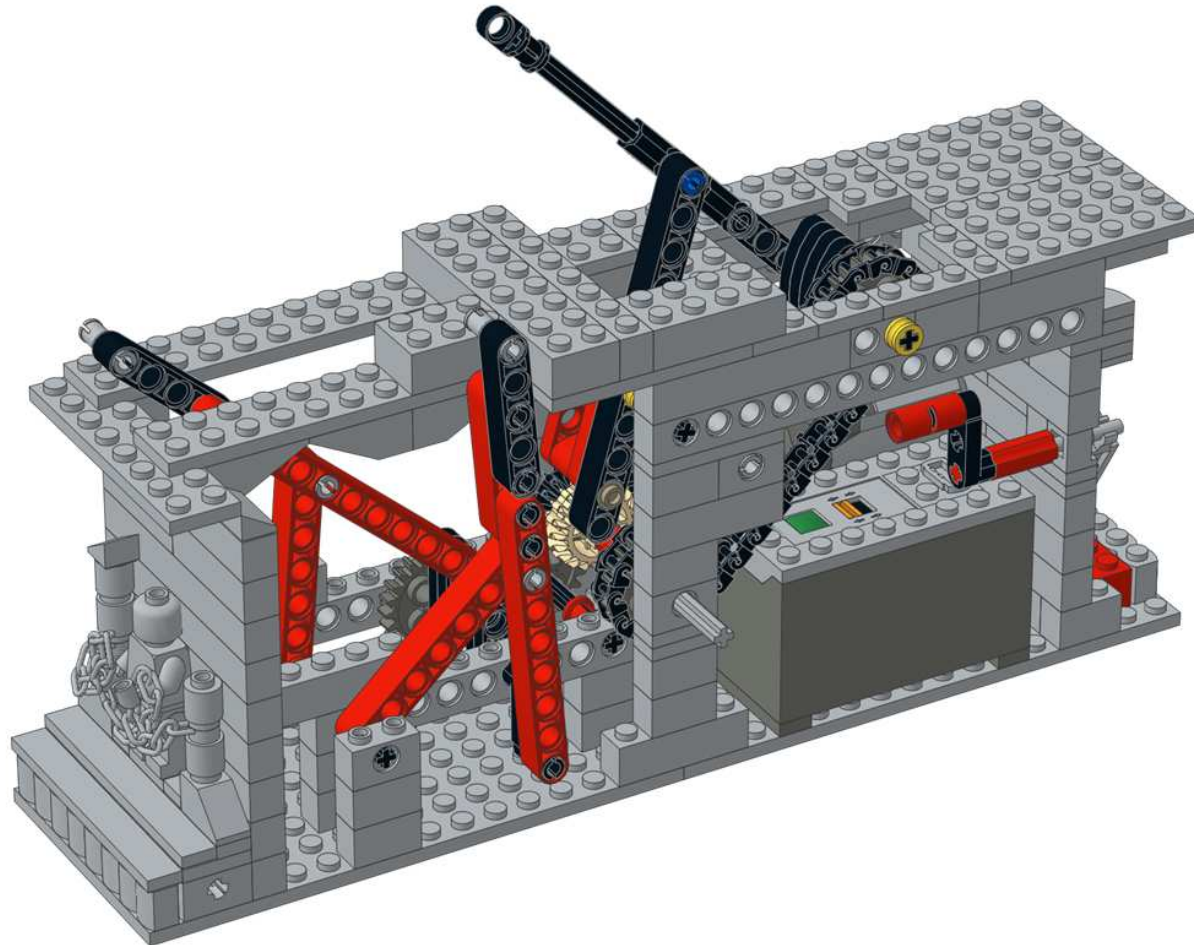

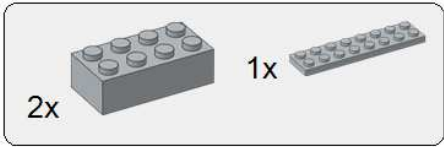

51

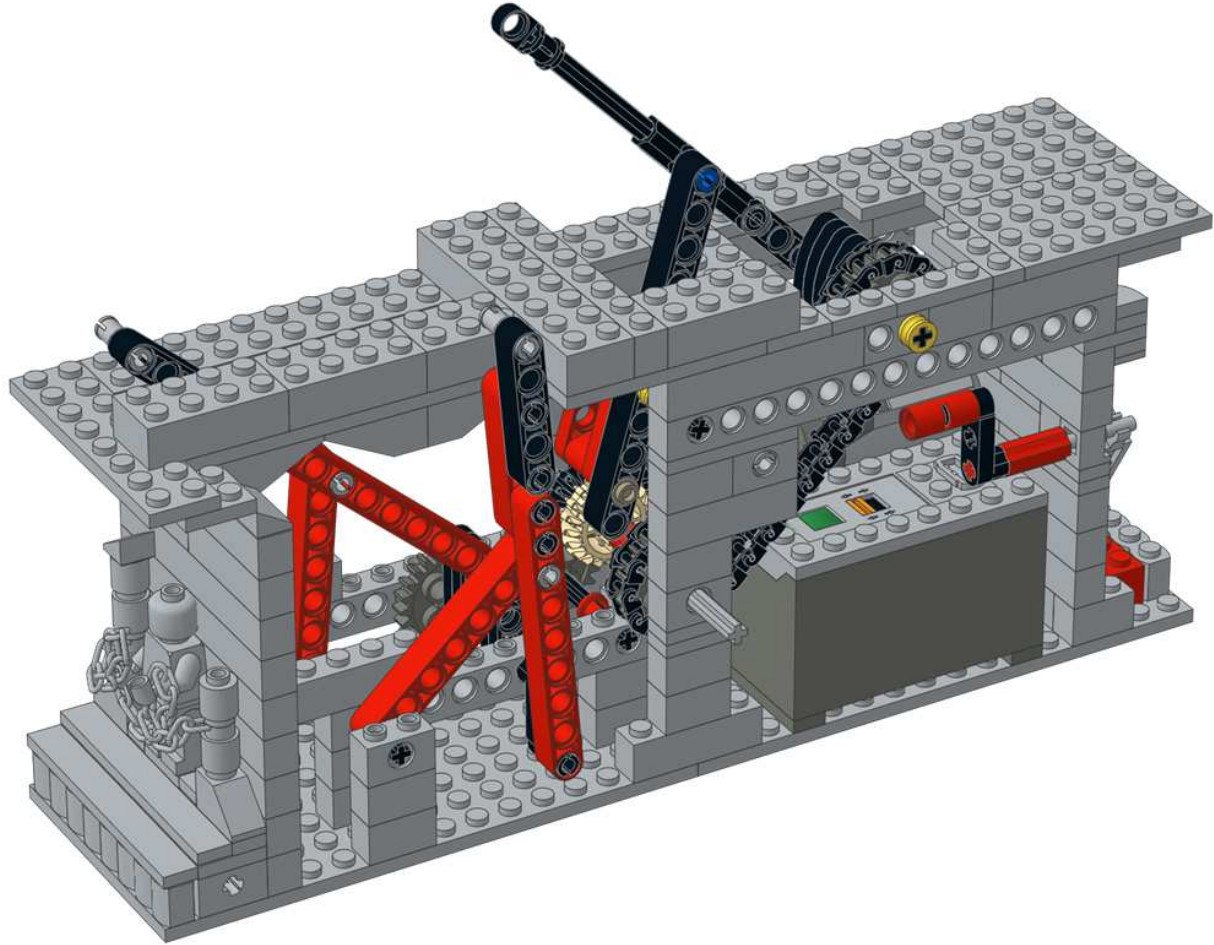

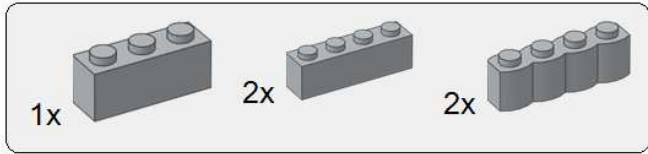

52

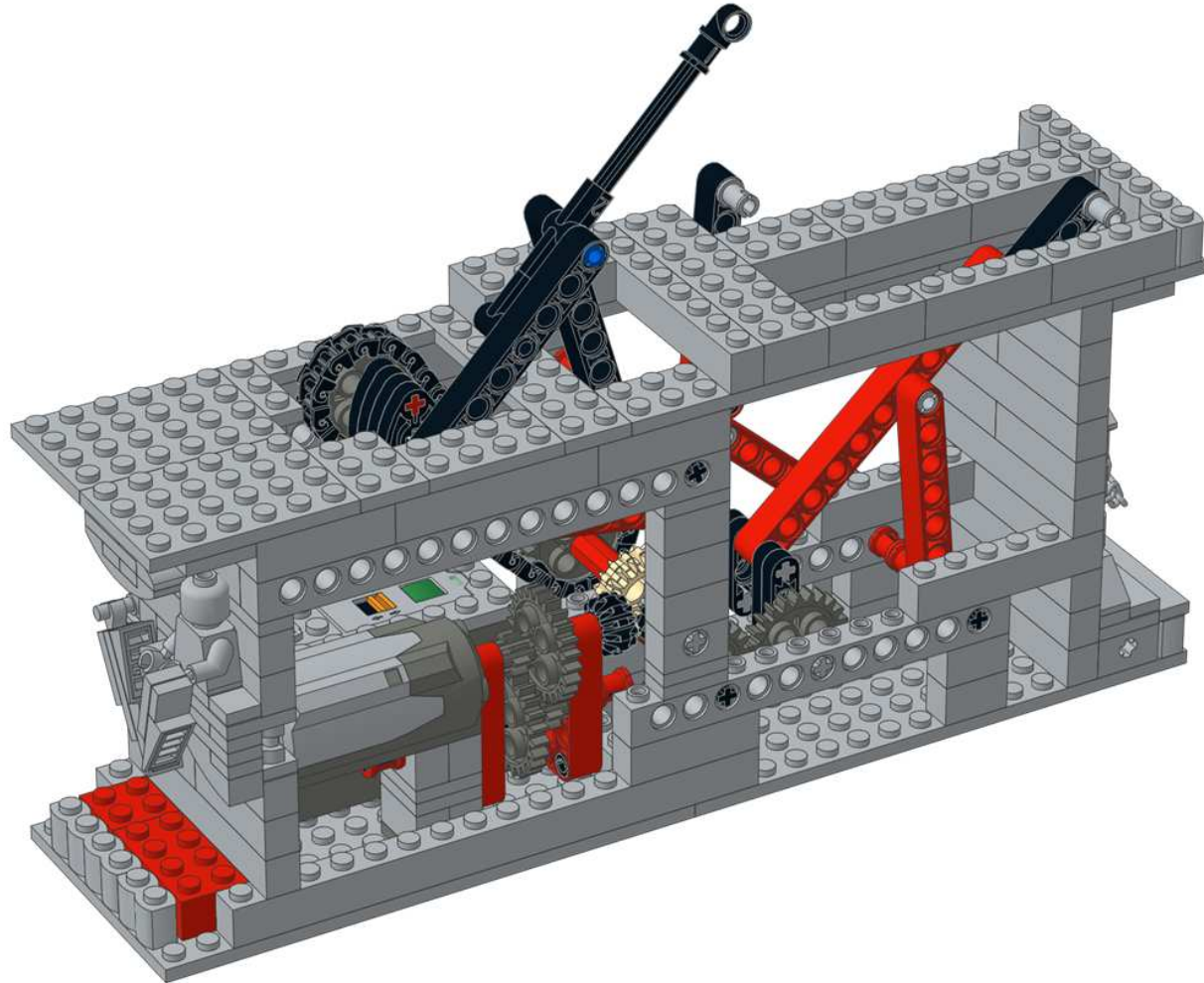

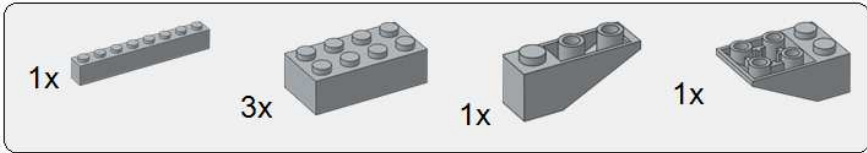

53

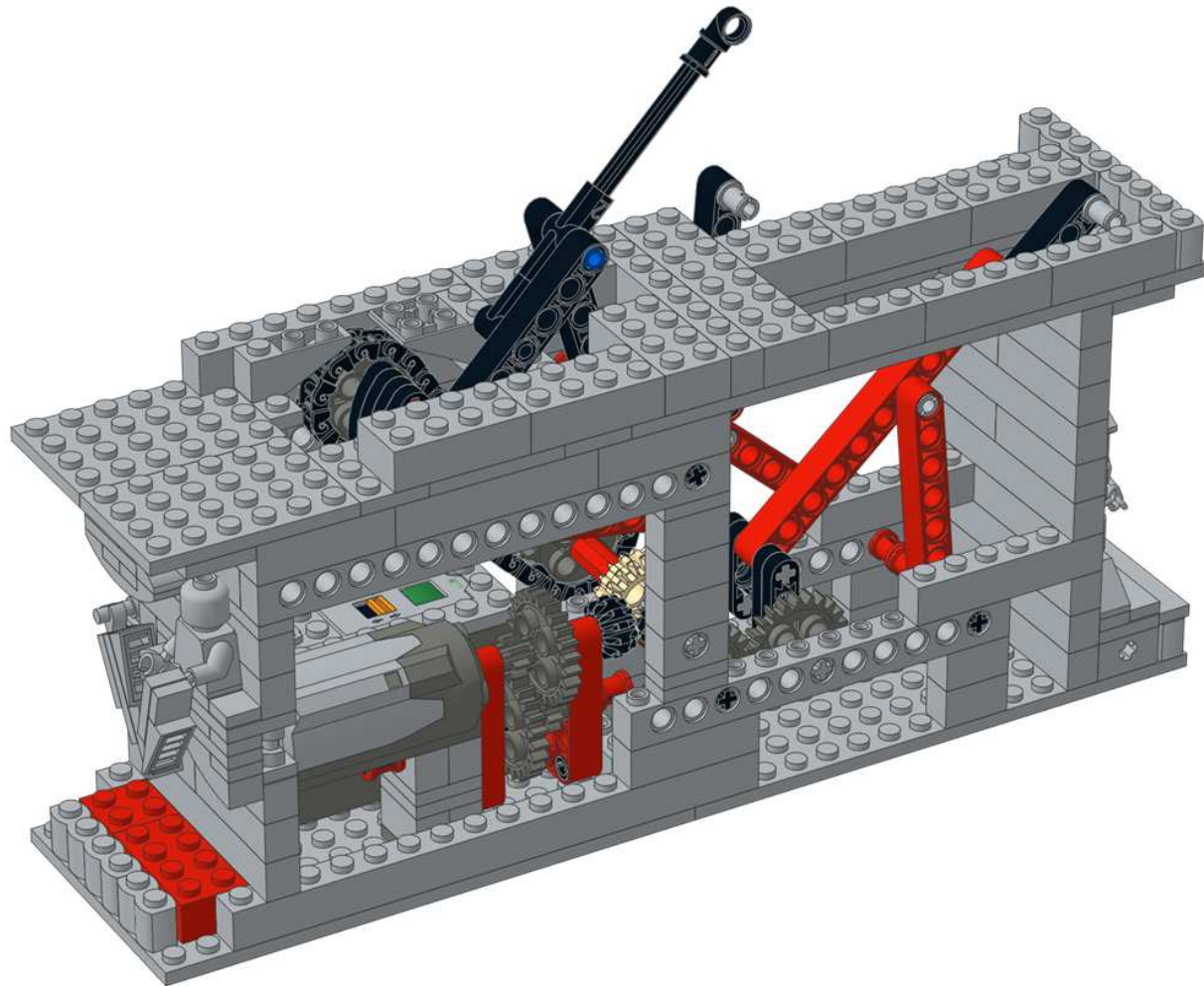

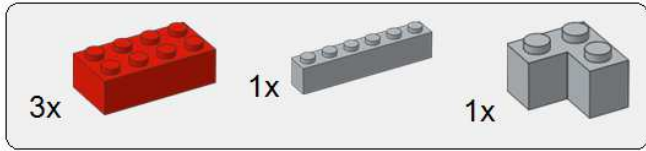

54

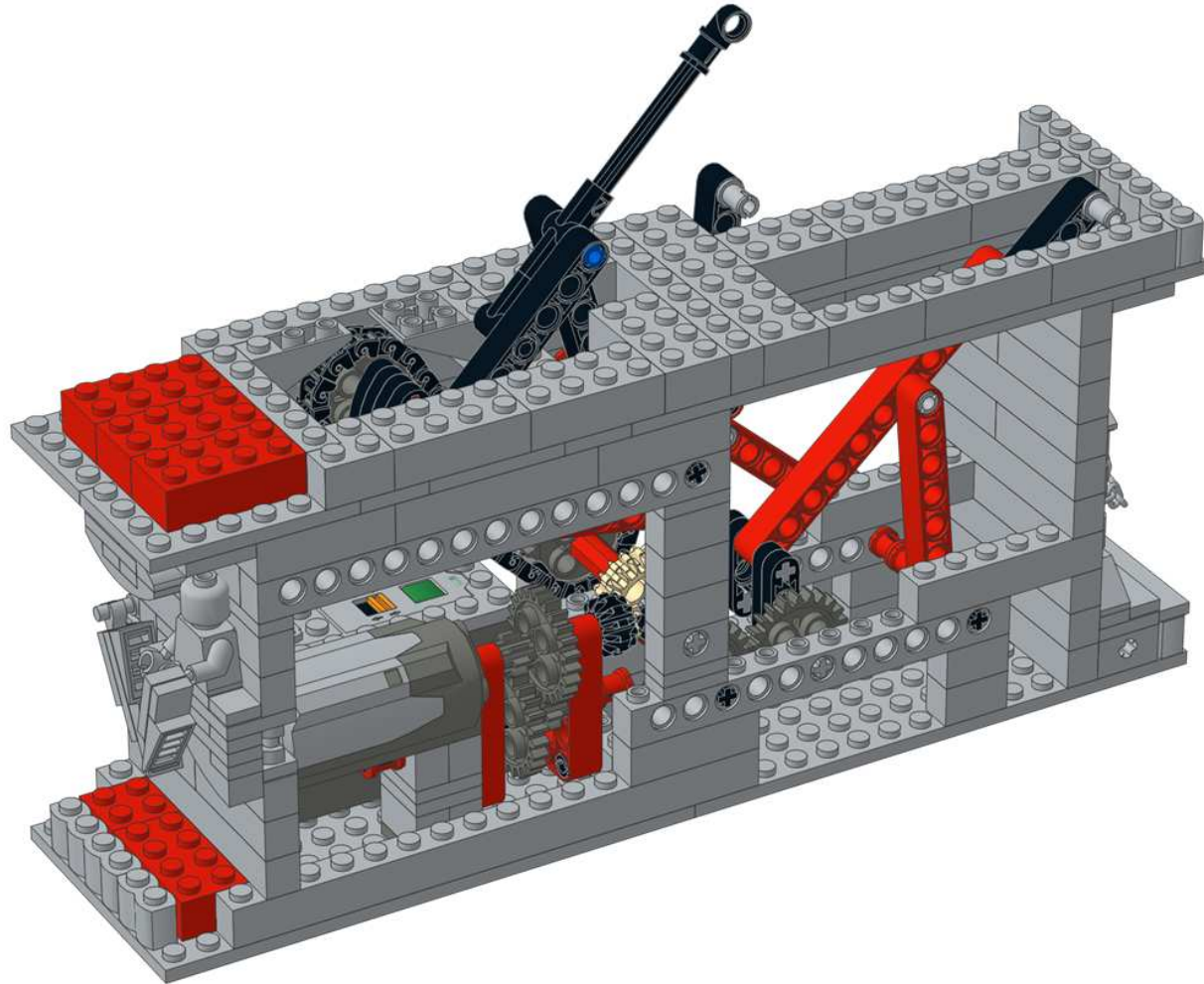

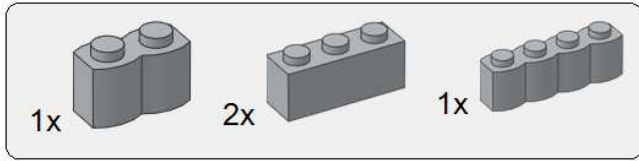

55

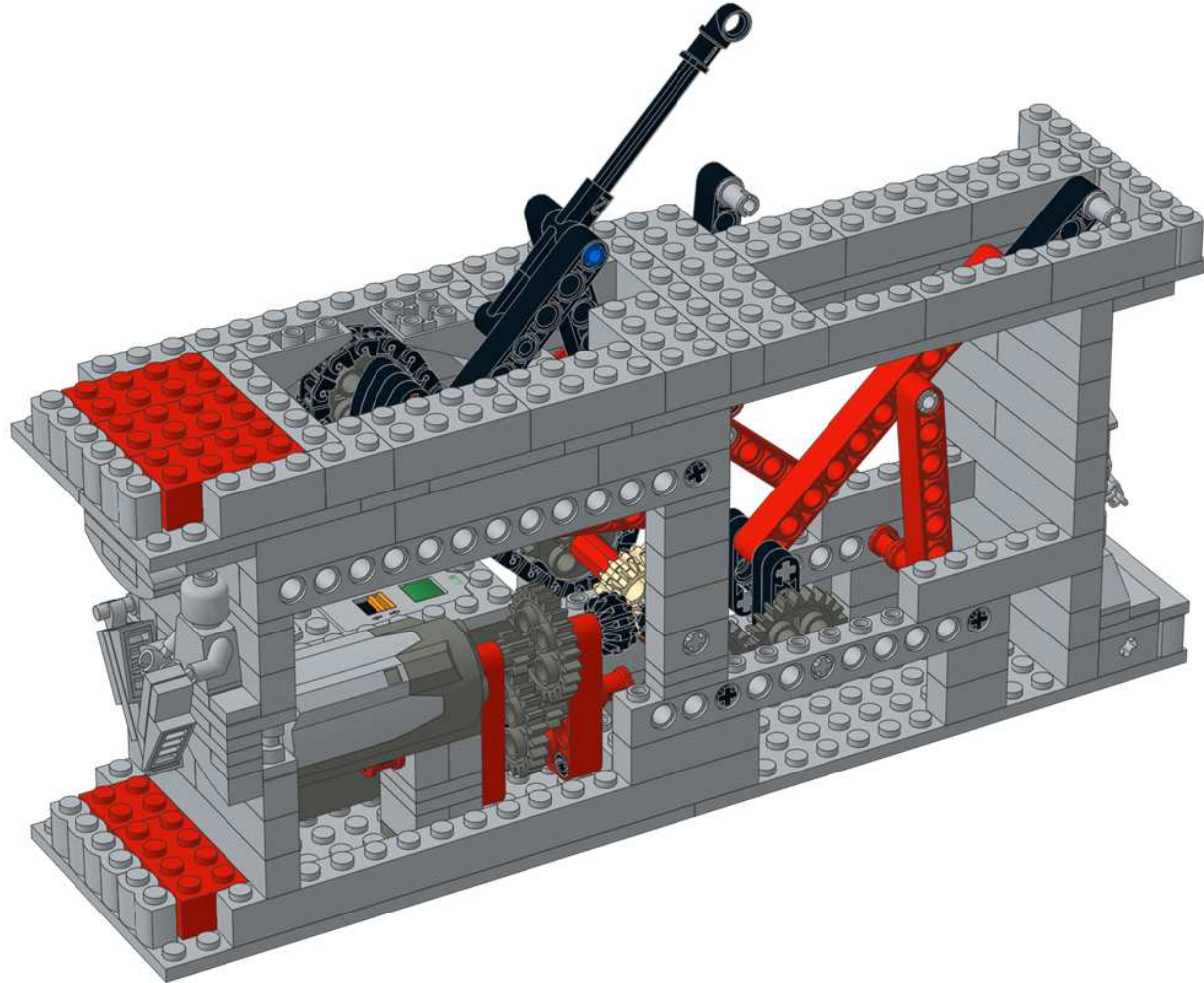

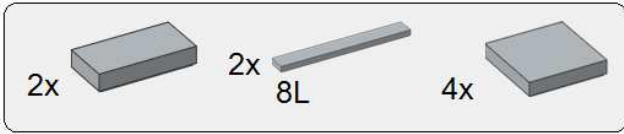

56

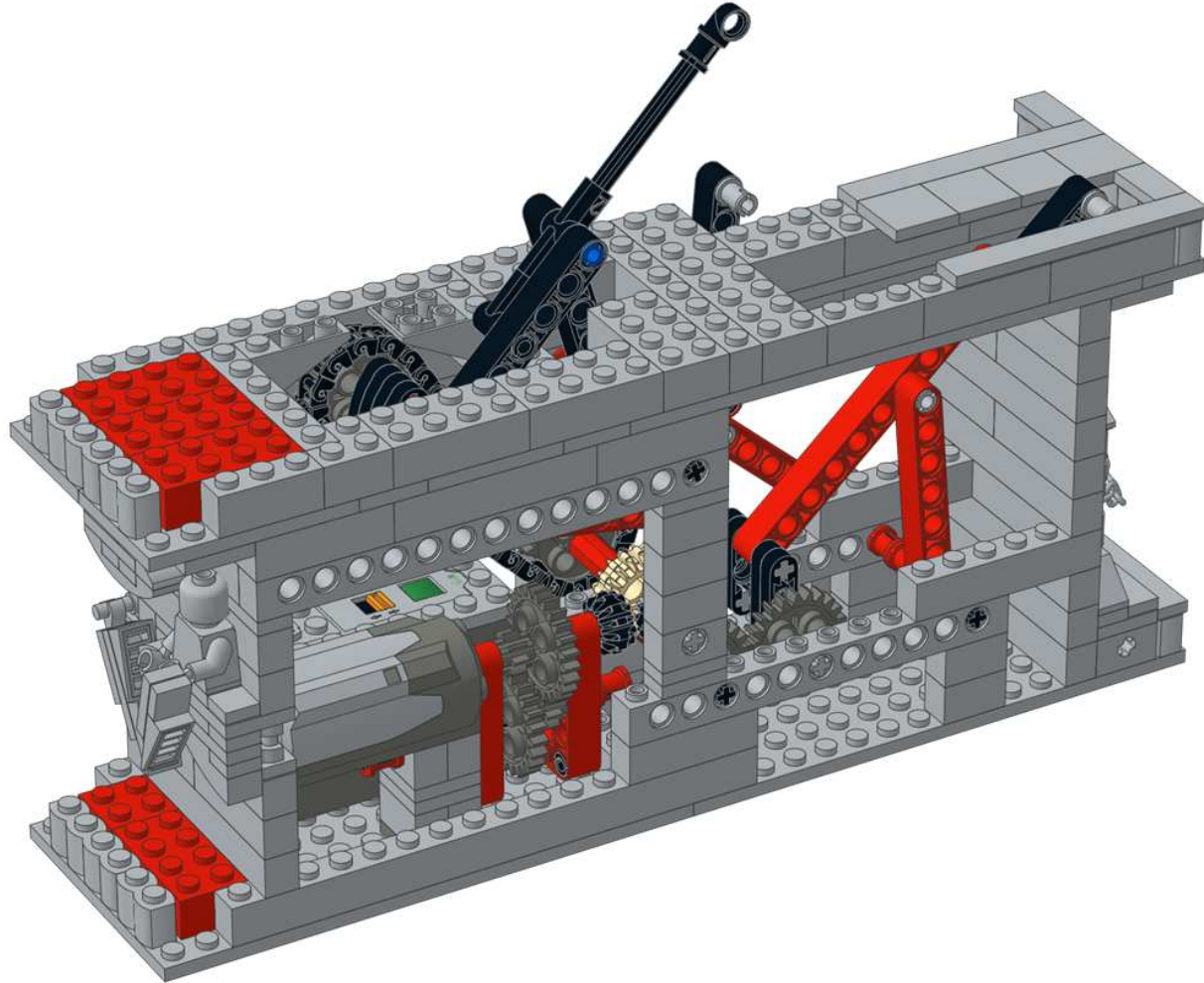

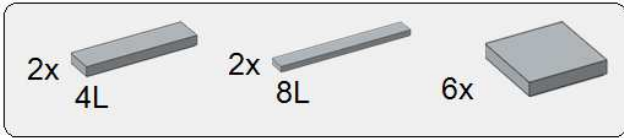

57

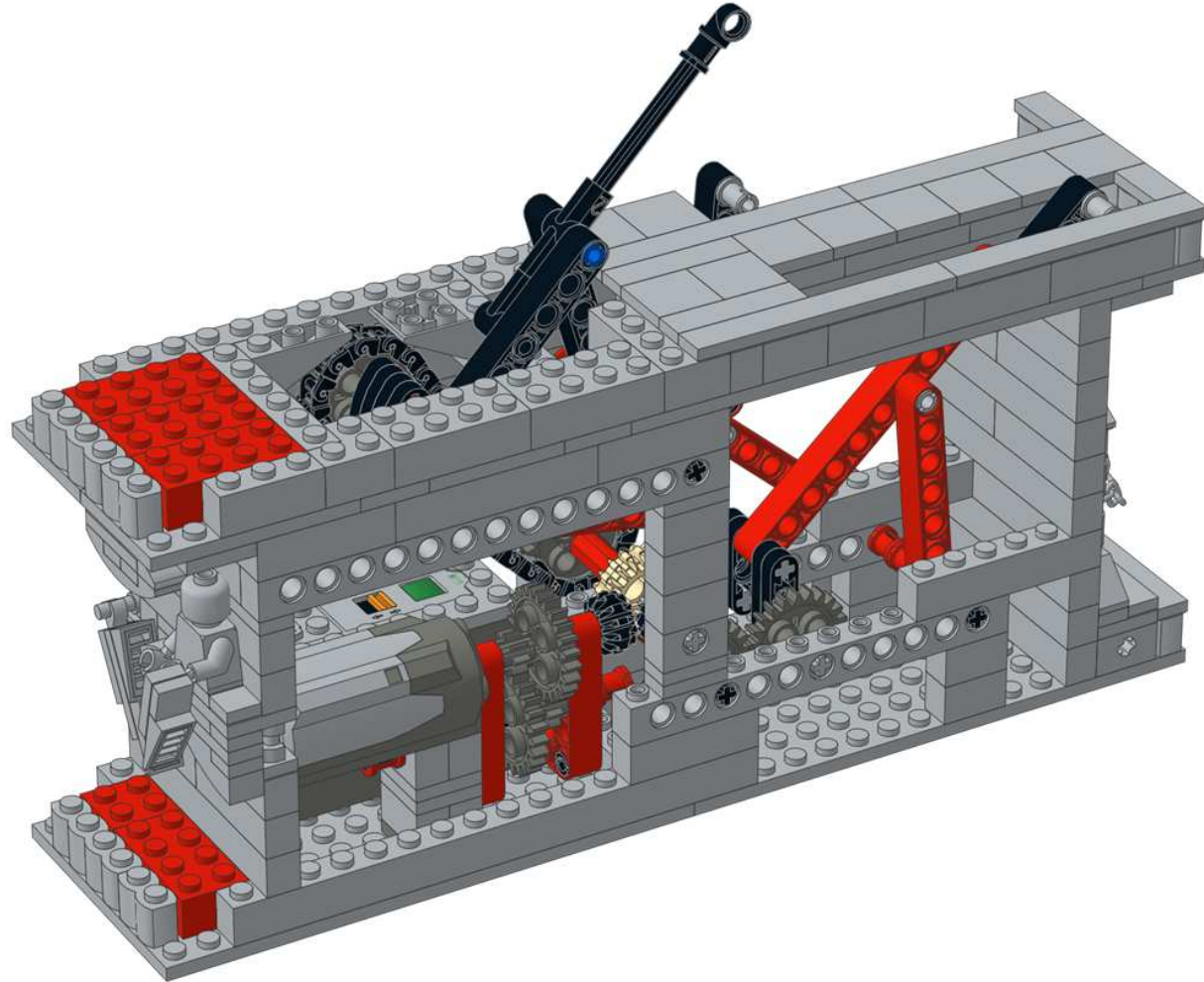

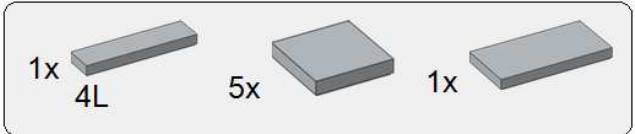

58

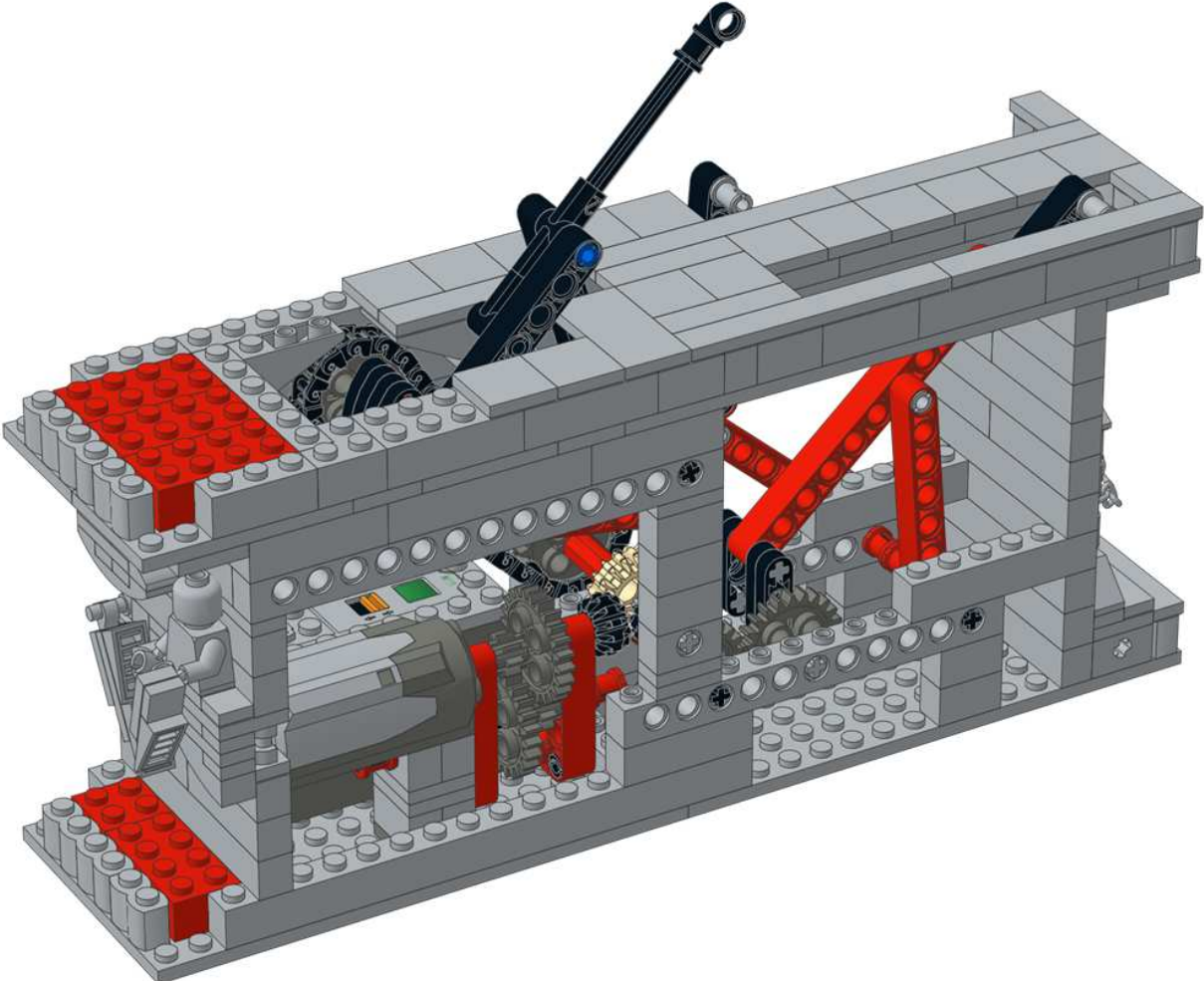

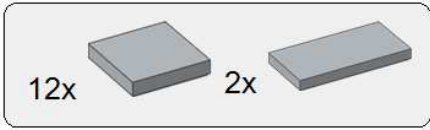

59

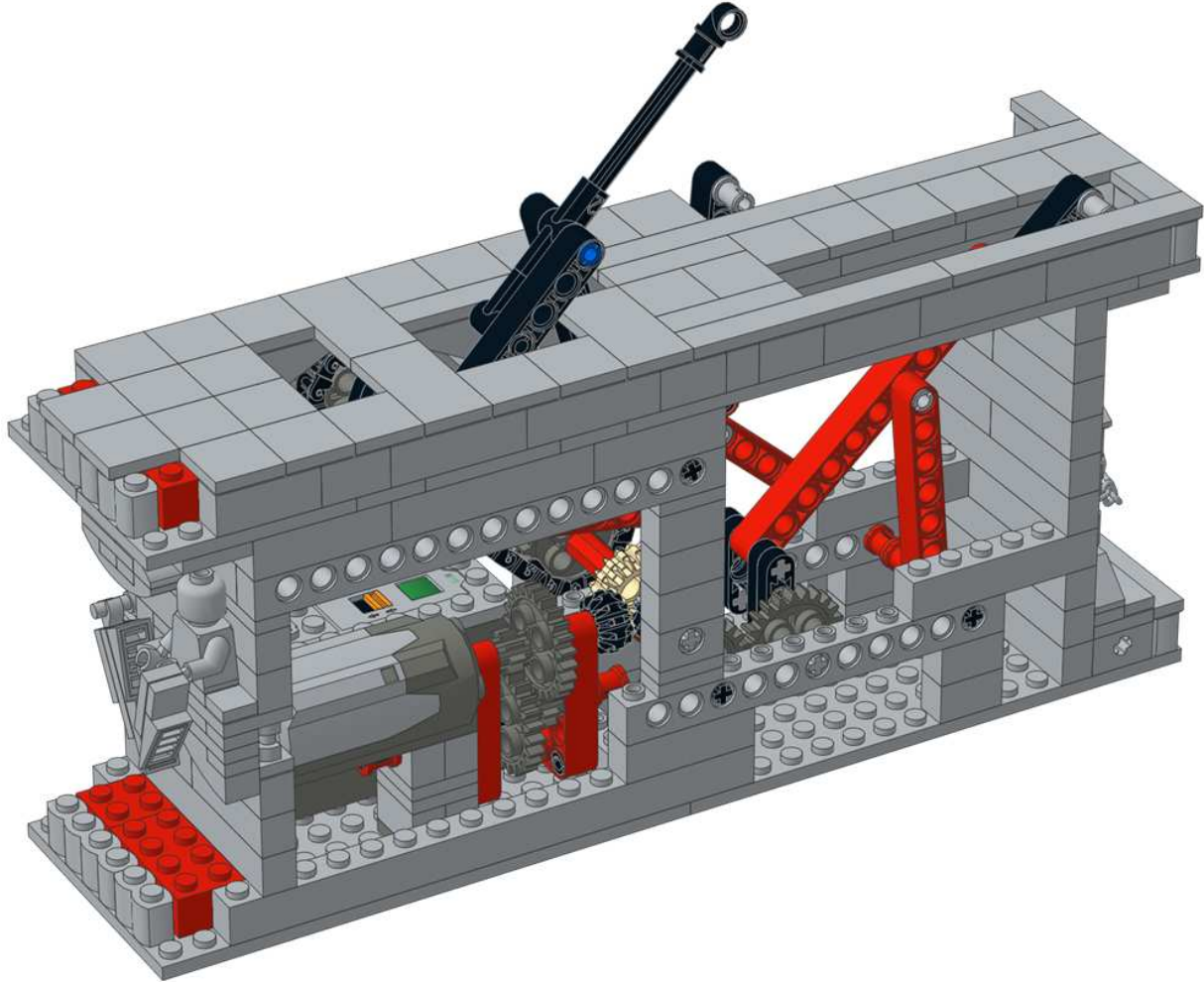

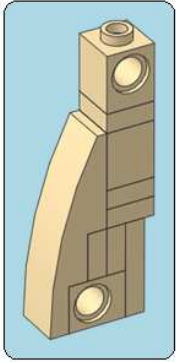

x2

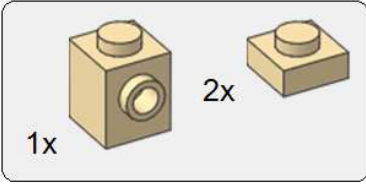

1

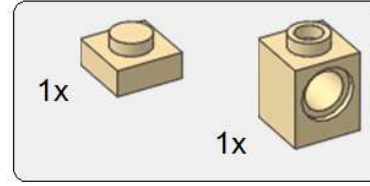
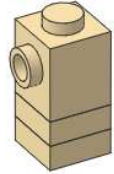

2

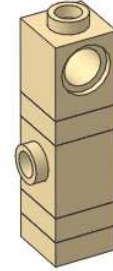

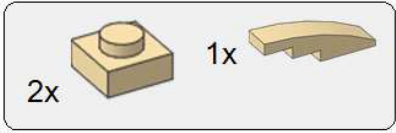

3

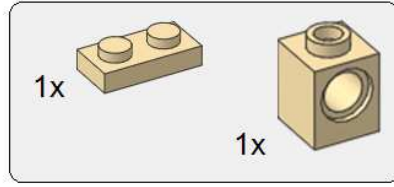
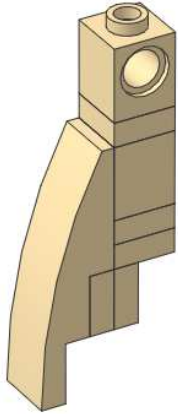

4

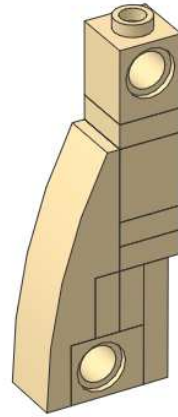

x2

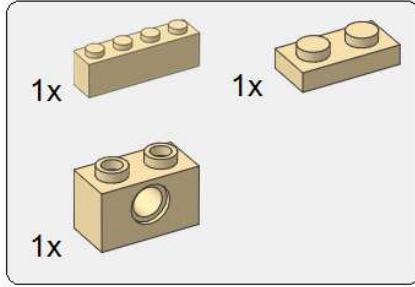
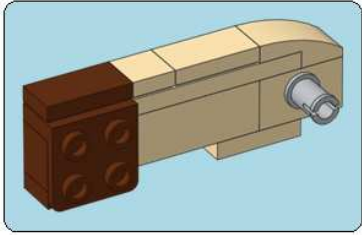

1

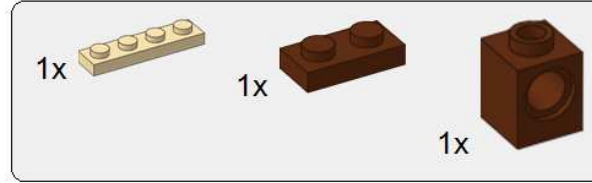
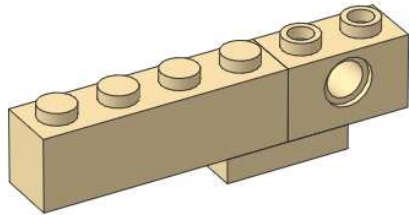

2

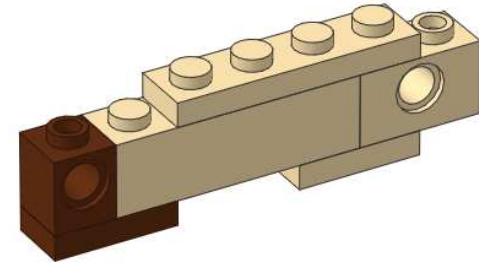

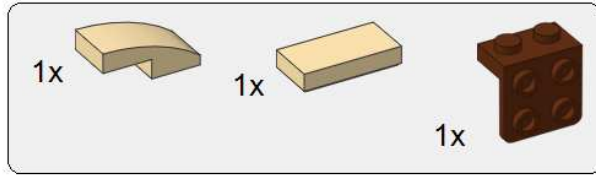

3

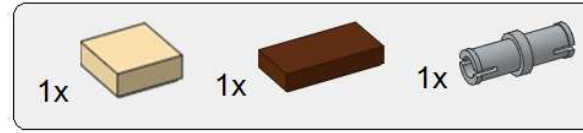
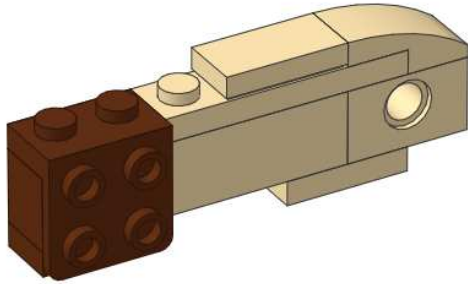

4

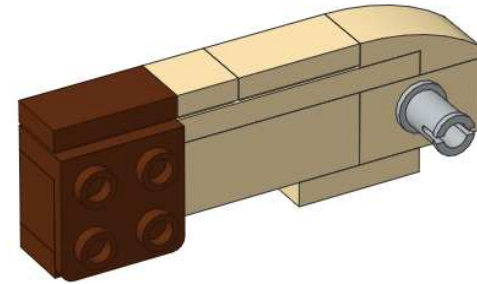

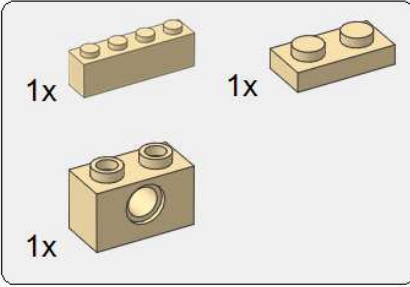
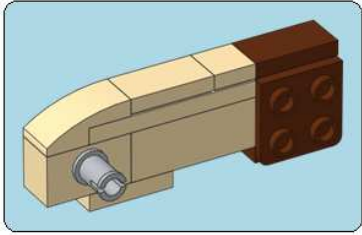

1

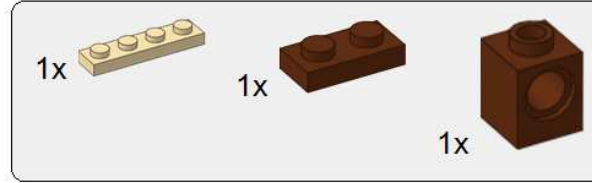
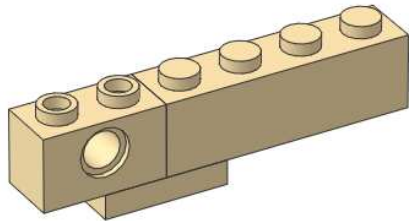

2

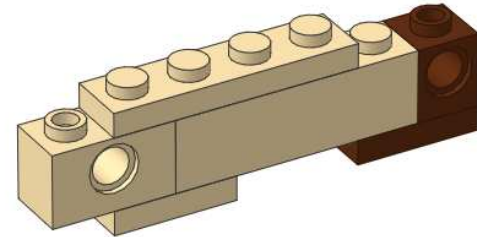

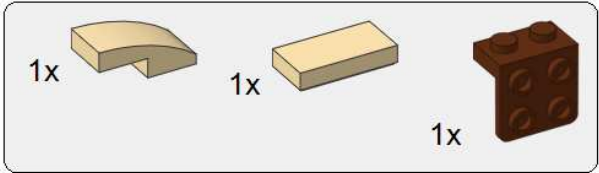

3

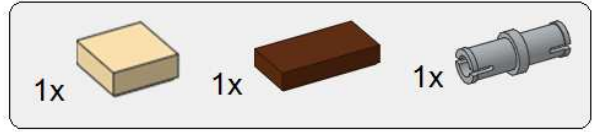
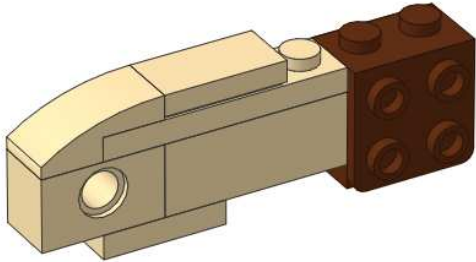

4

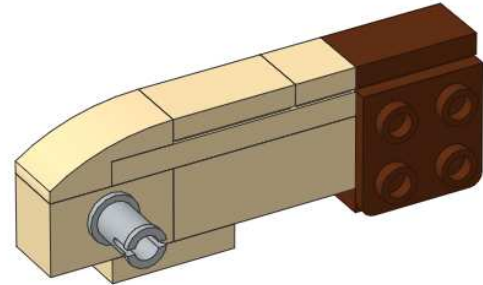

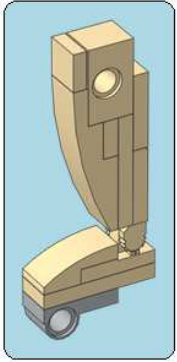

x2

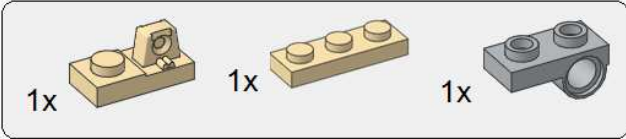

1

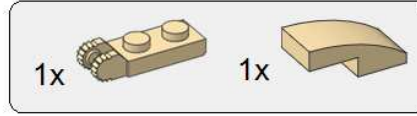
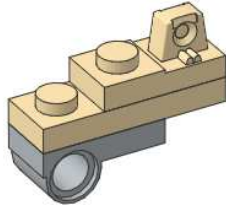

2

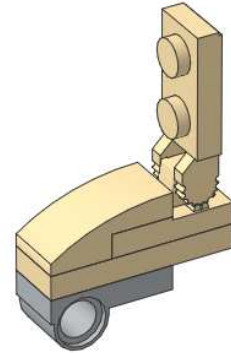

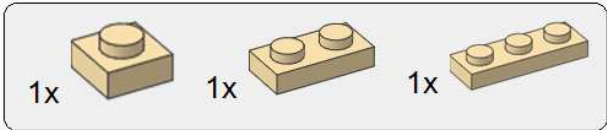

3

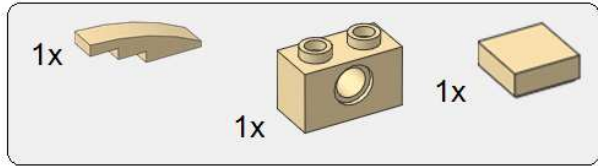
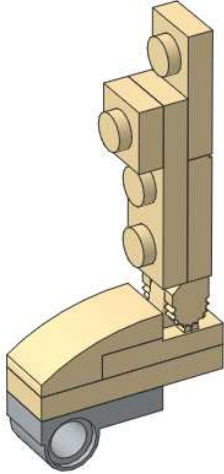

4

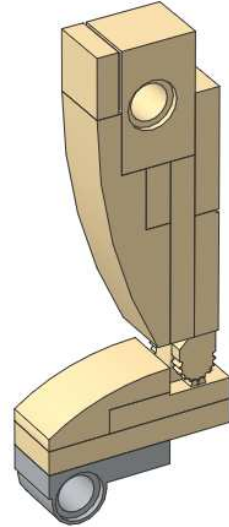

x2

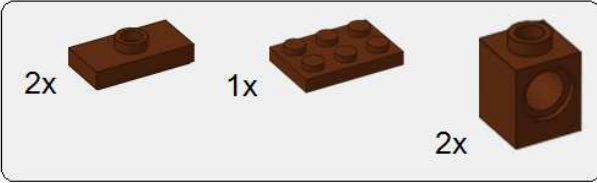
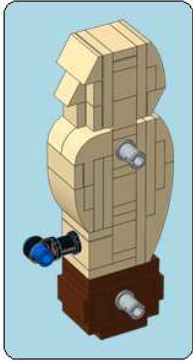

1

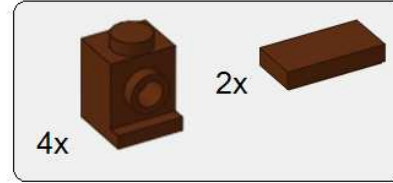
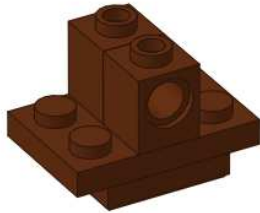

2

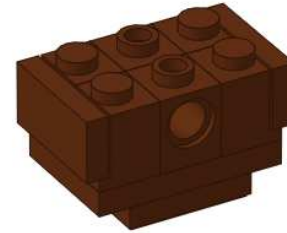

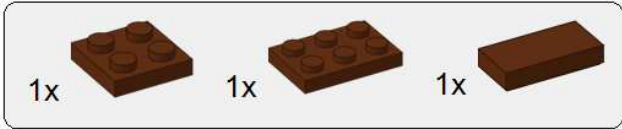

3

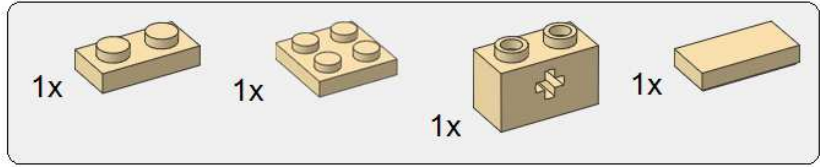
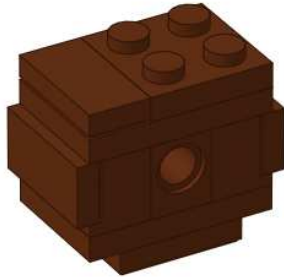

4

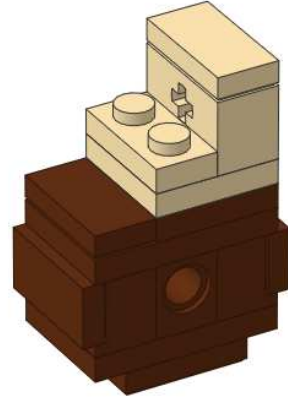

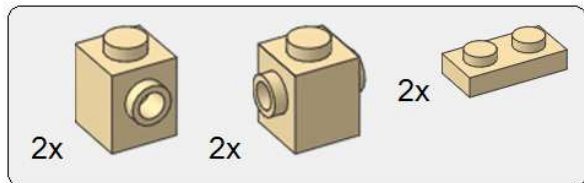

5

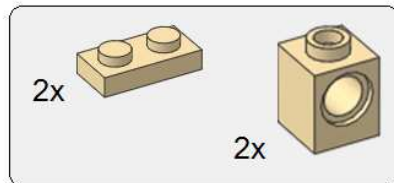
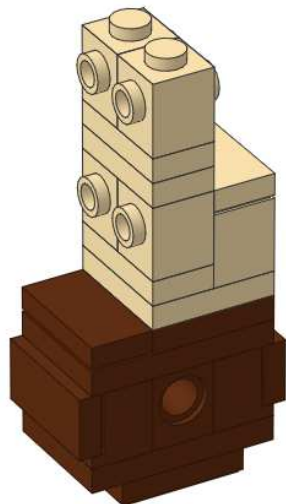

6

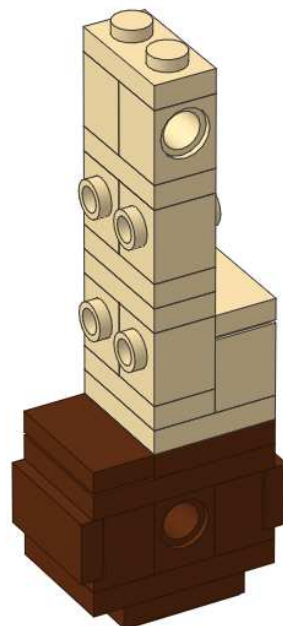

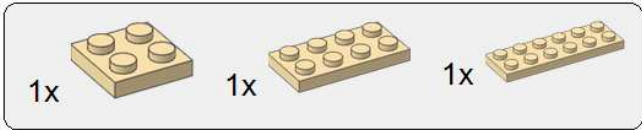

7

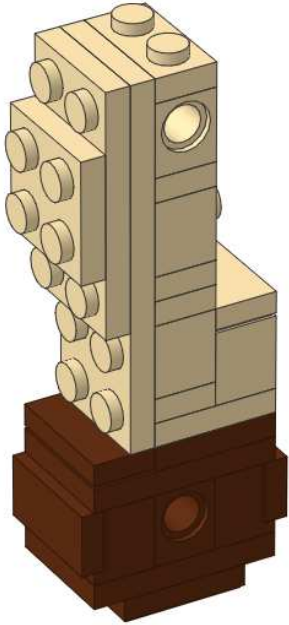

8

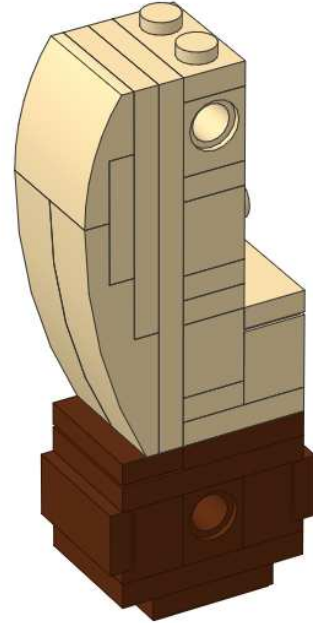

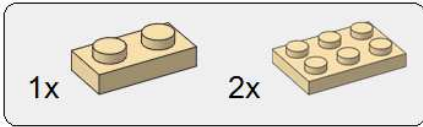

9

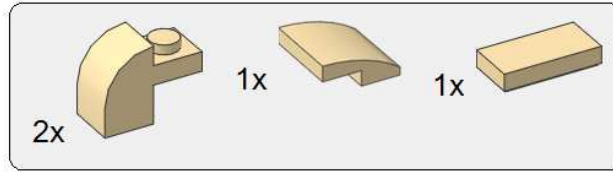
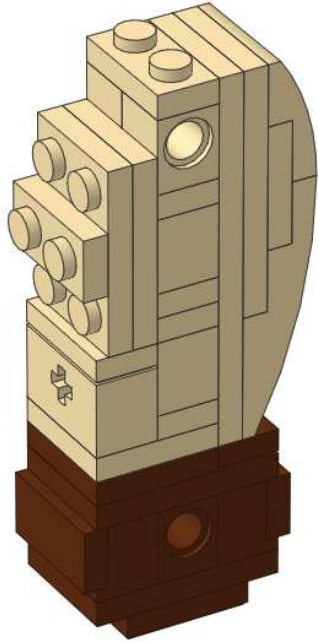

10

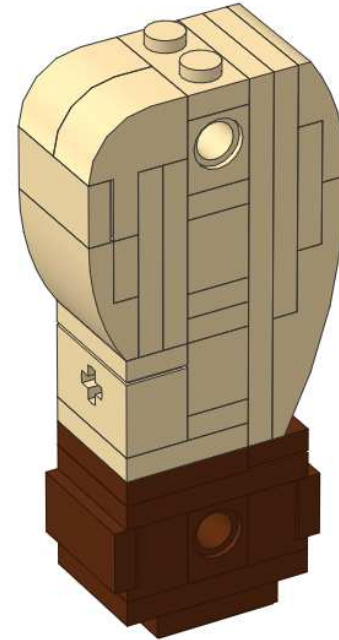

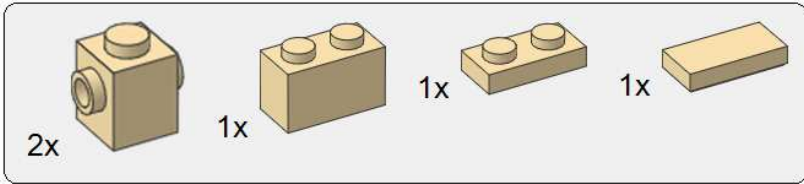

11

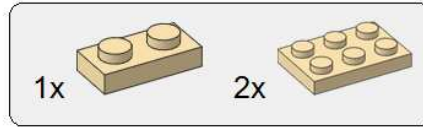
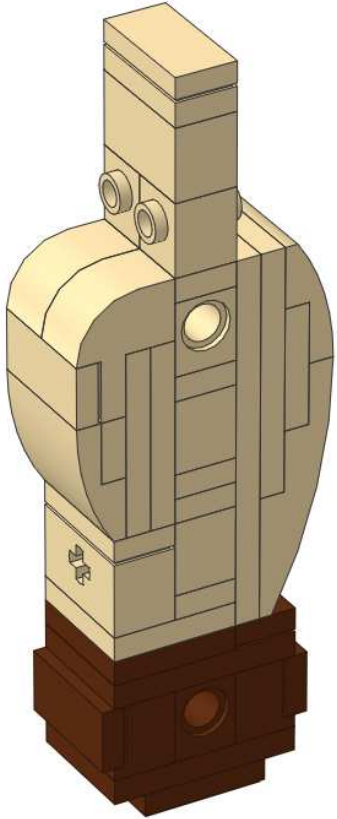

12

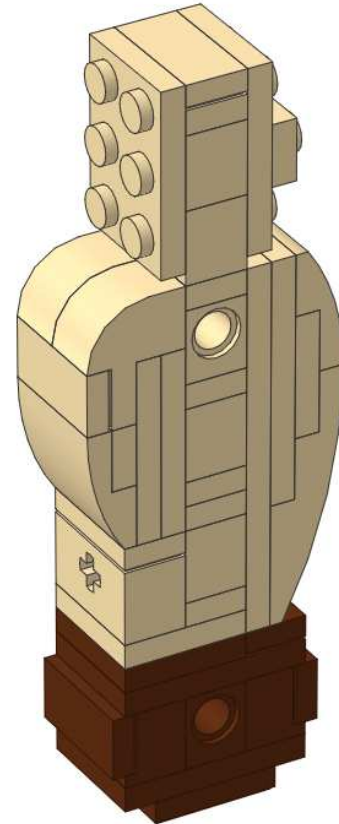

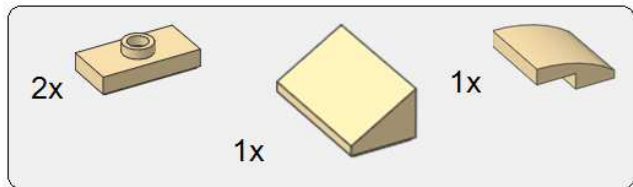

13

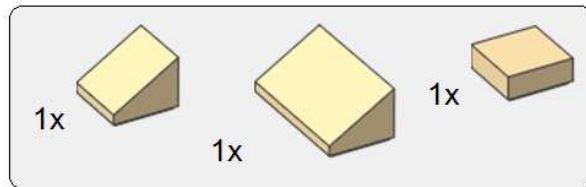
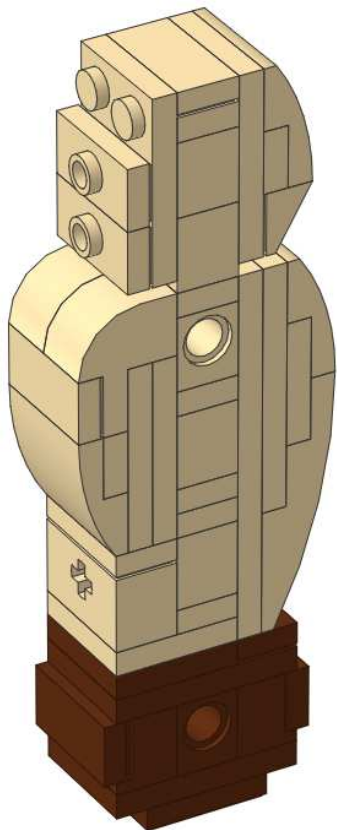

14

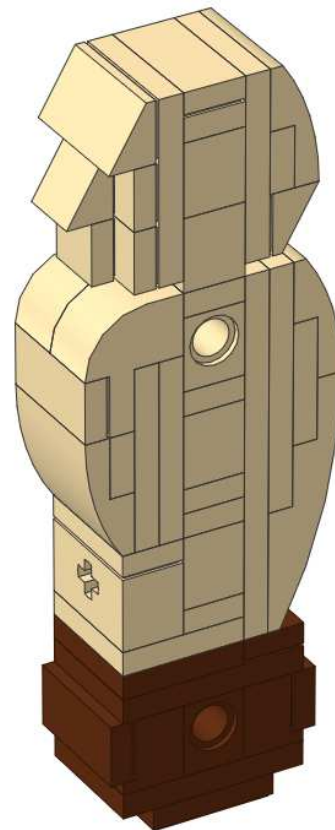

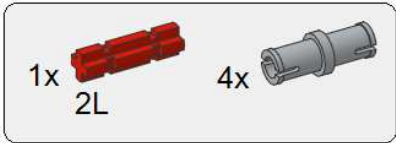

15

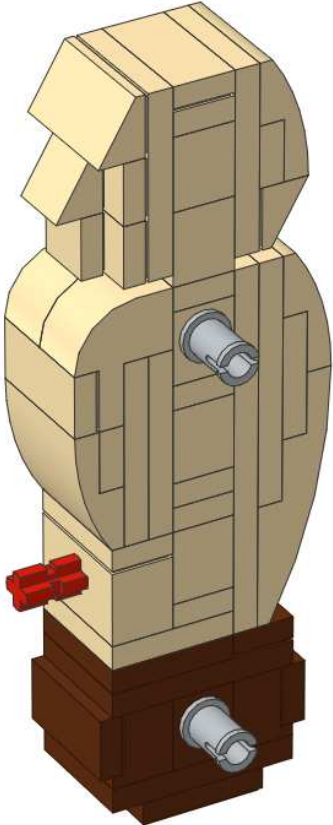

16

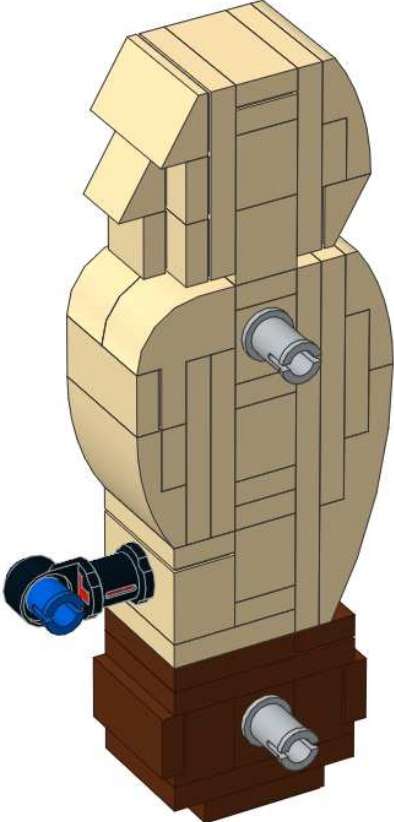

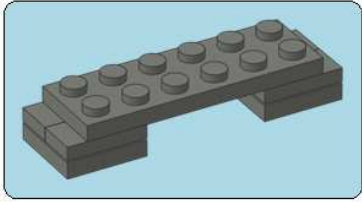

x5

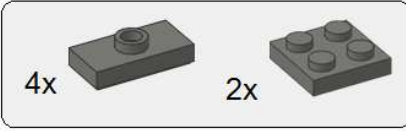

1

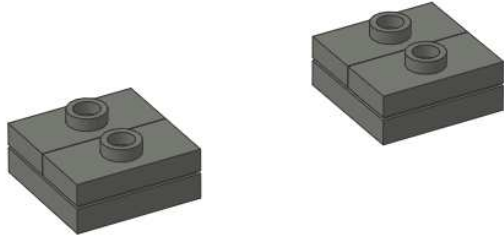

2



x5

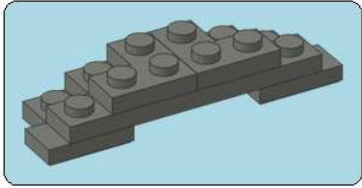

x12

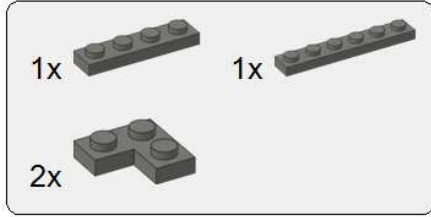

1

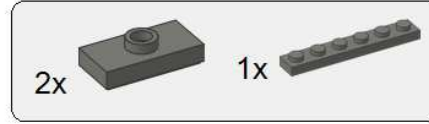
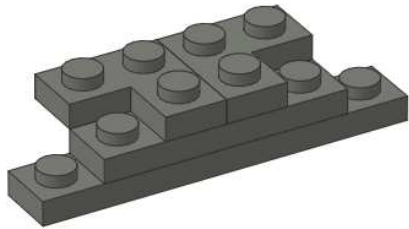

2

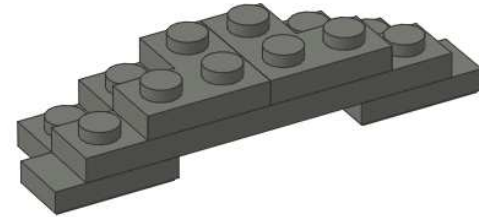

x12

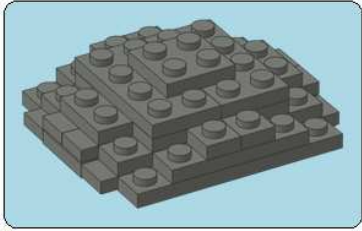

x5

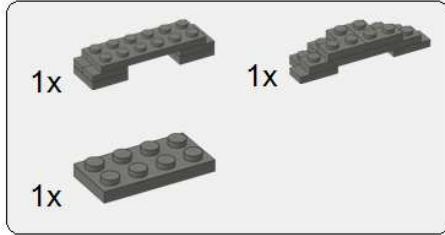

1

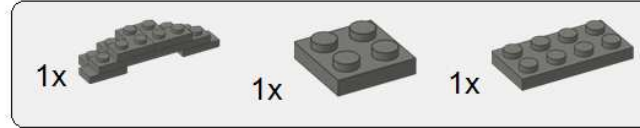
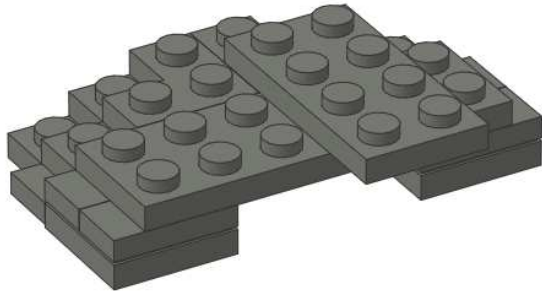

2

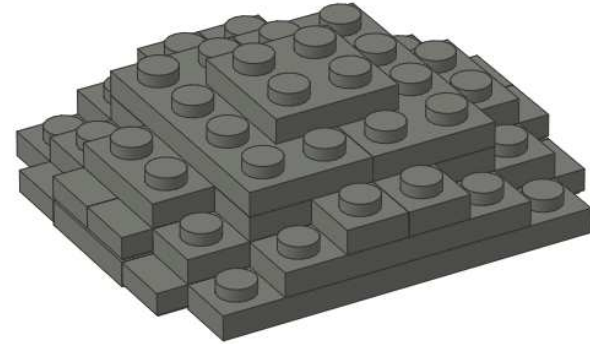

x5

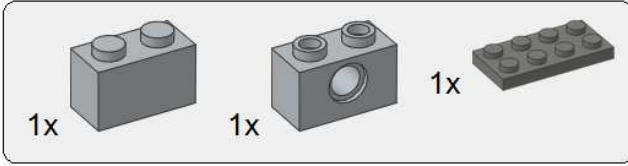
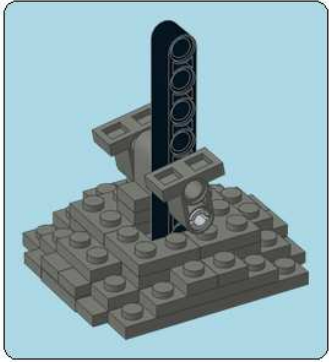

1

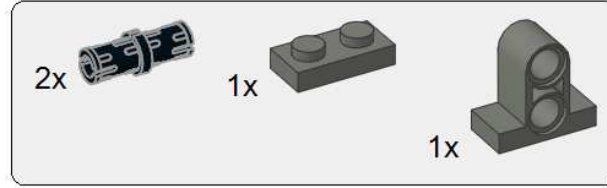
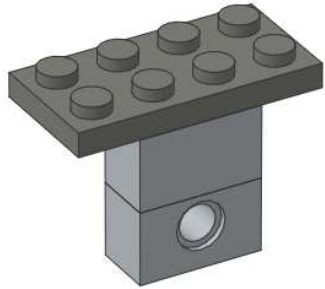

2

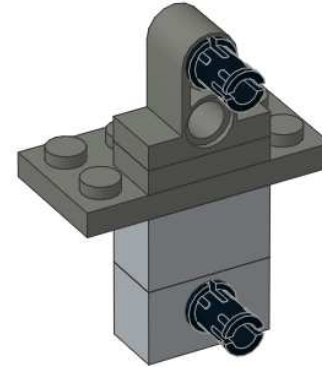

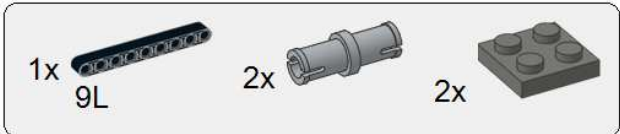

3

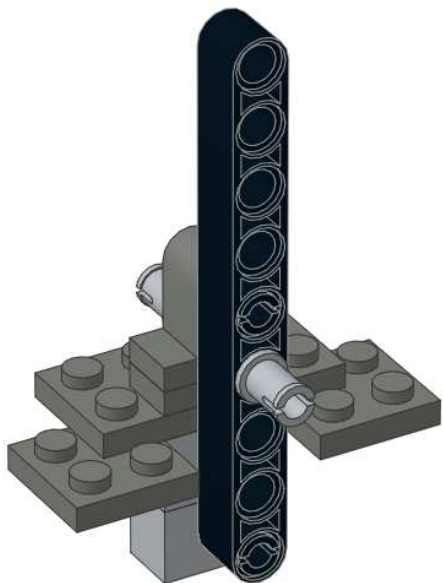

4

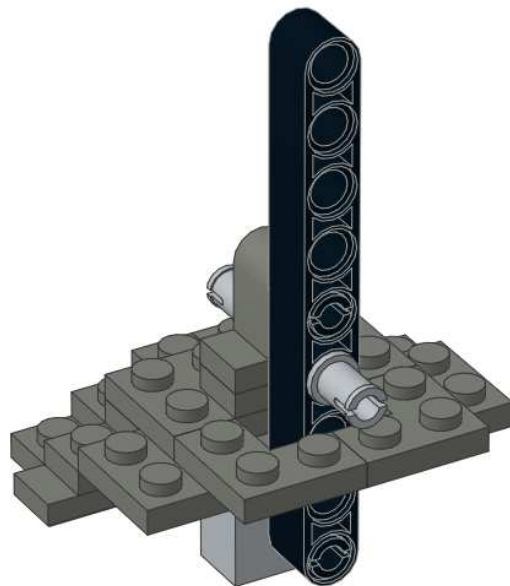

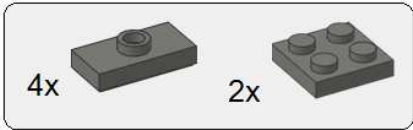

5

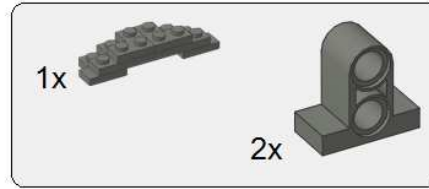
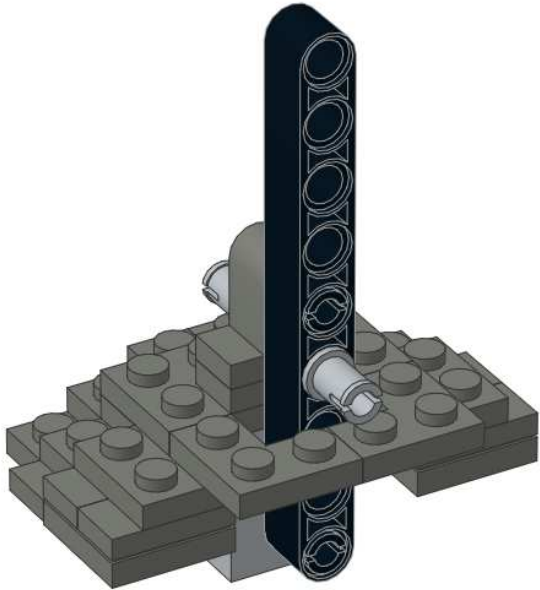

6

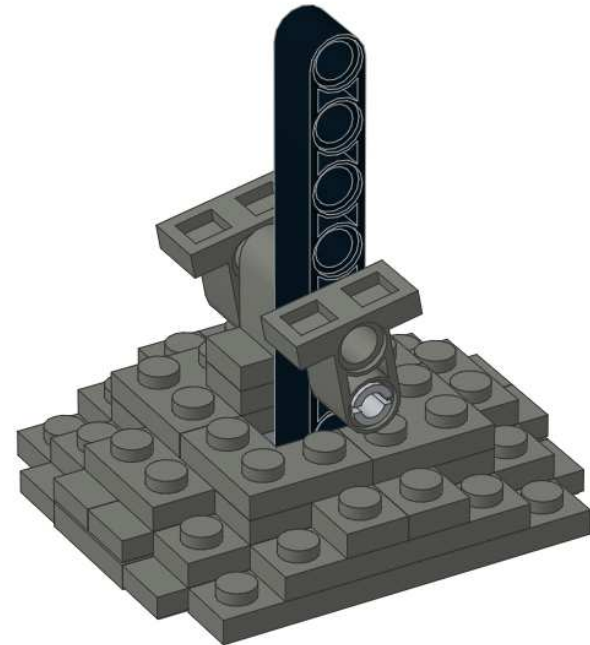

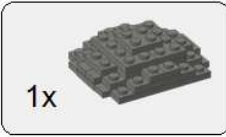
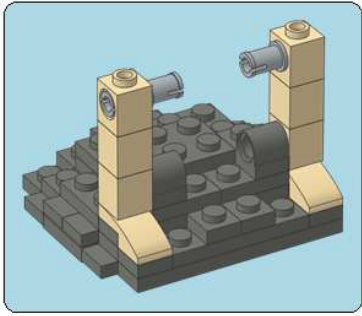

1

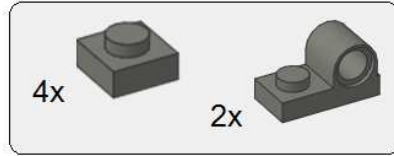
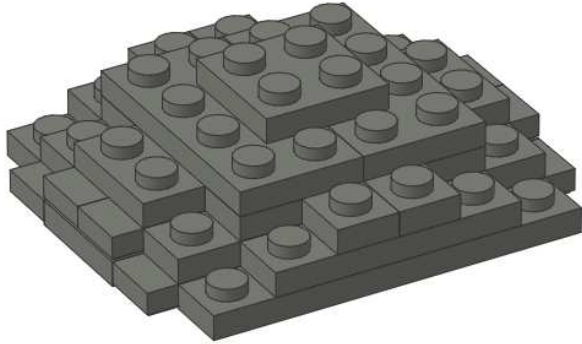

2

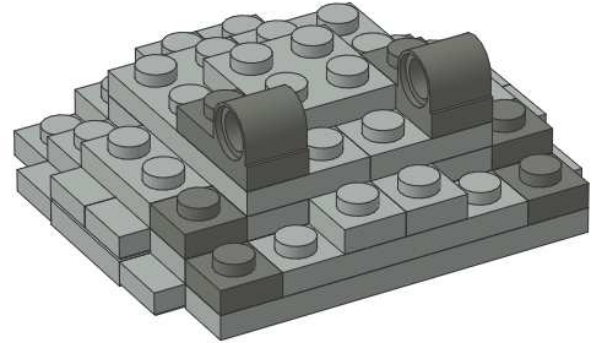

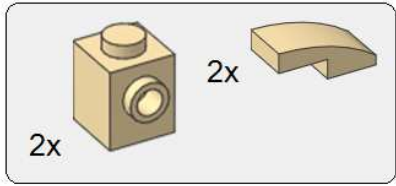

3

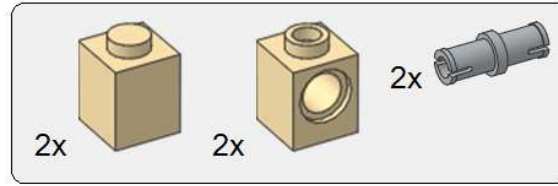
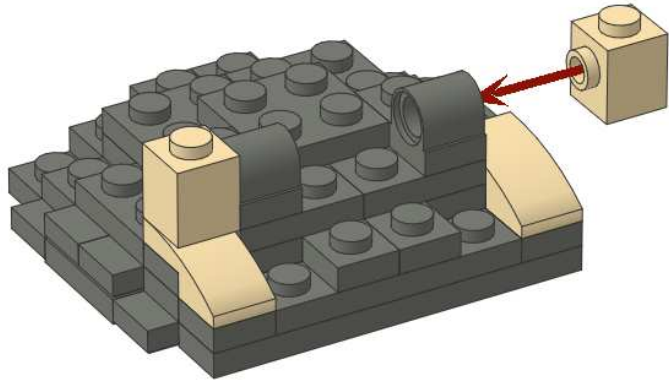

4

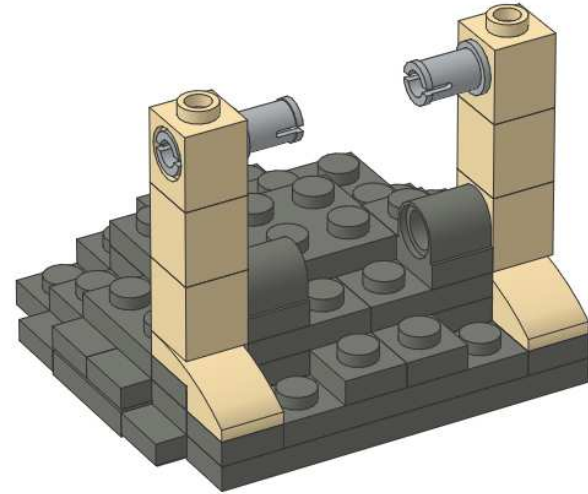

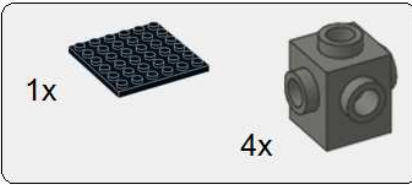
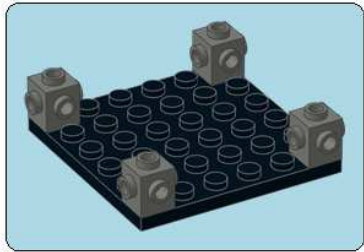

x2

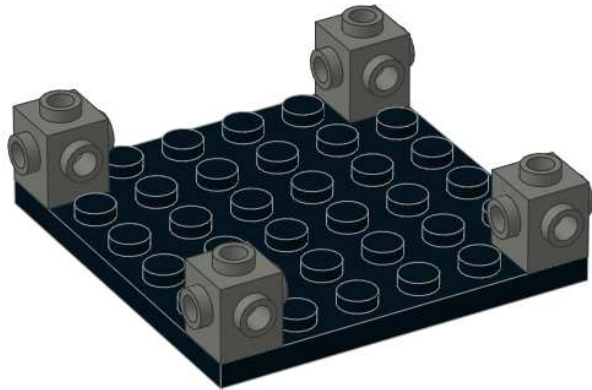

x2

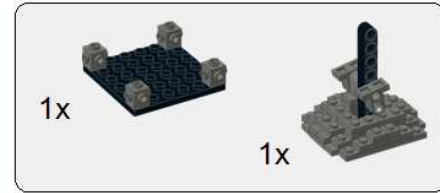
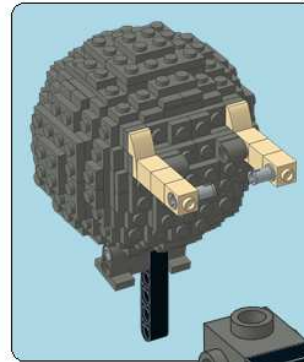

1



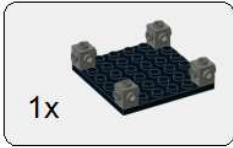

2

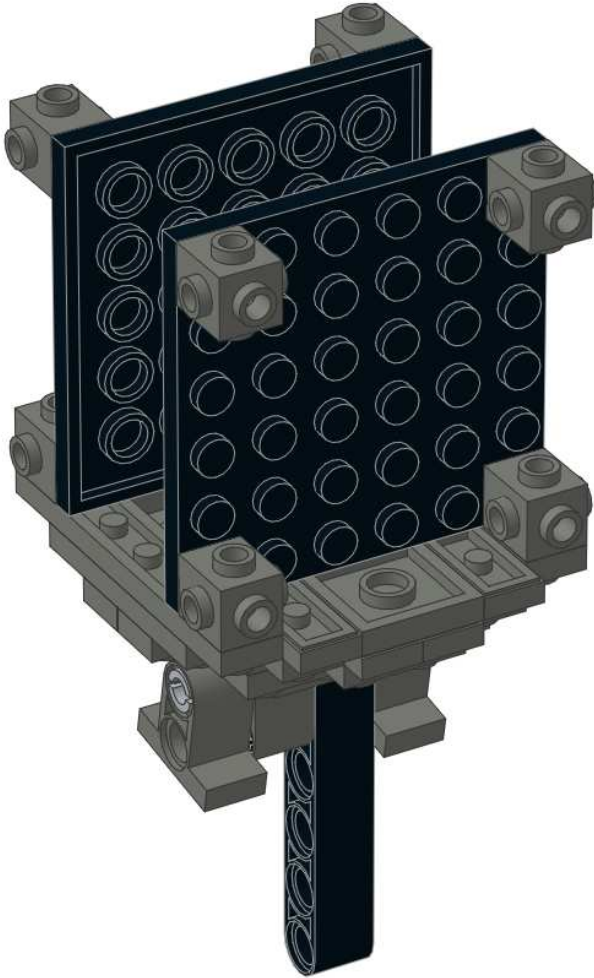

3

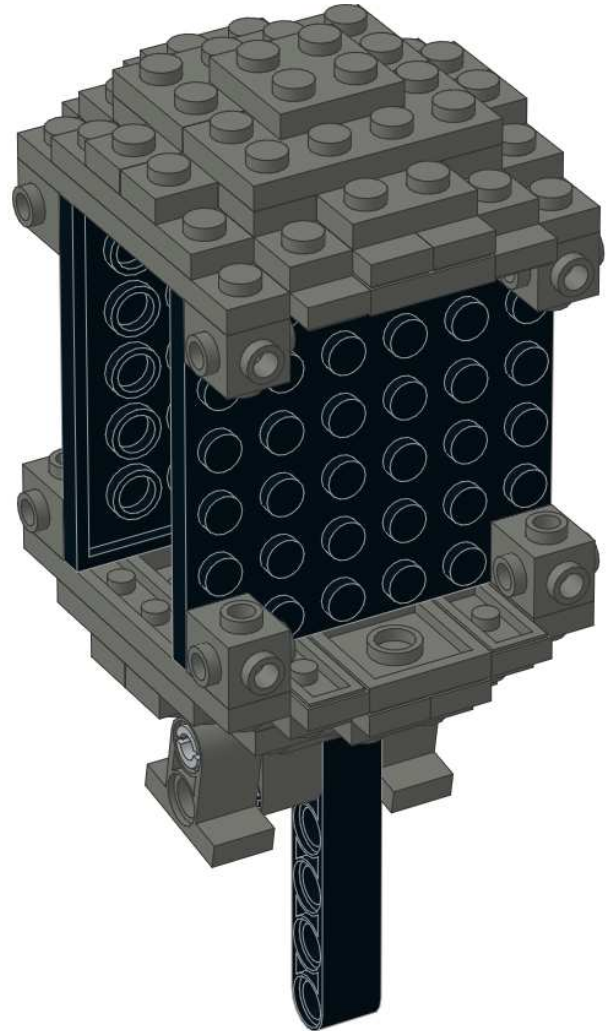



4

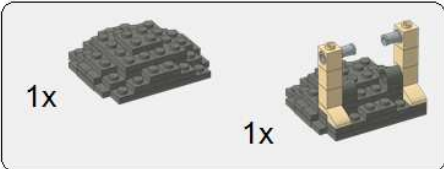
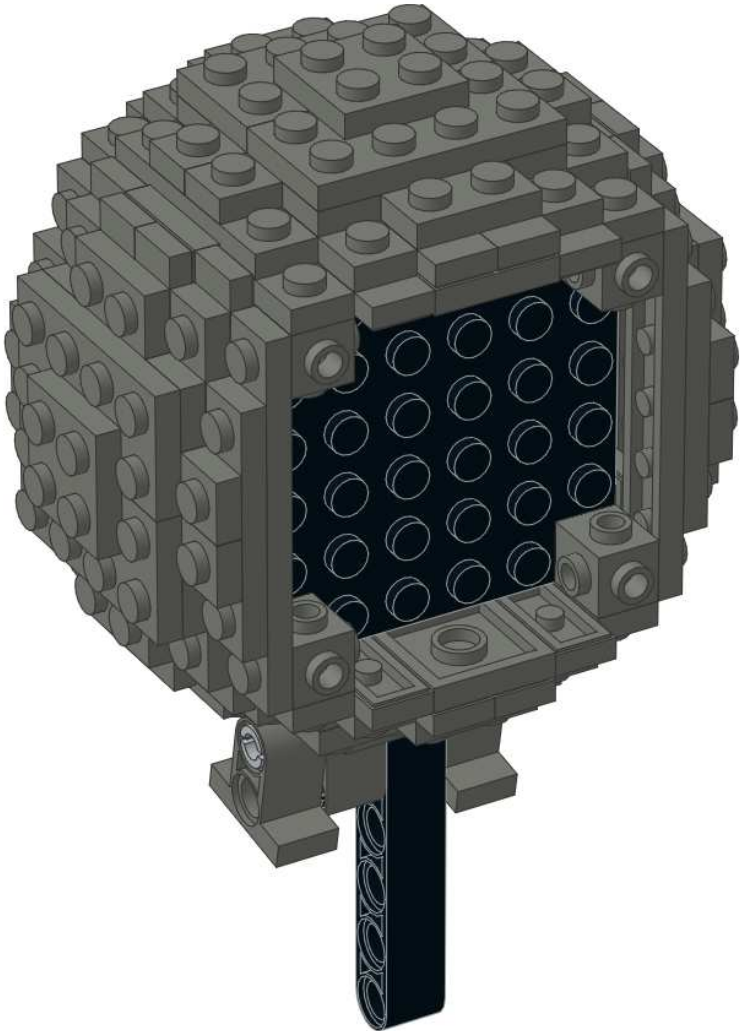

5

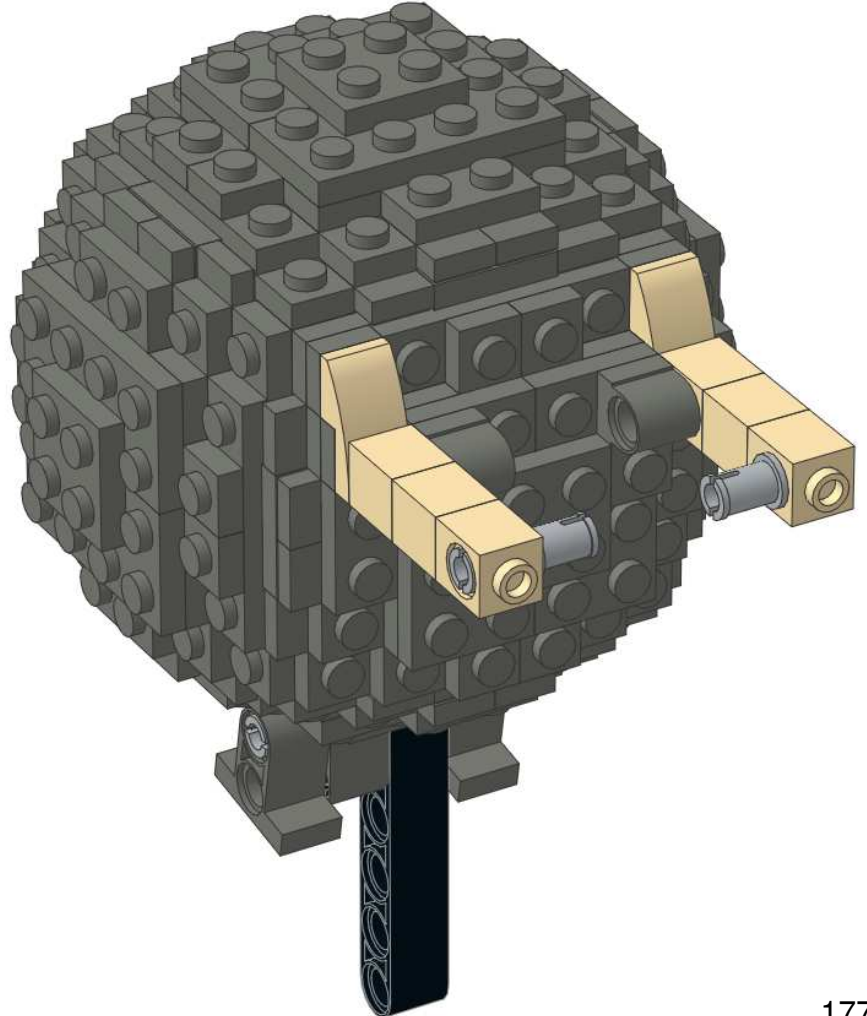

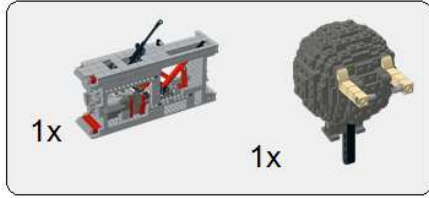
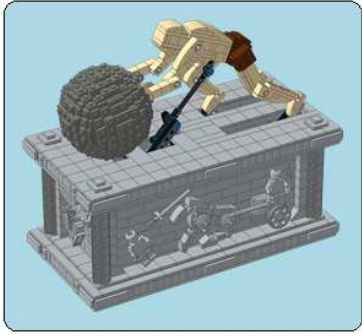

1

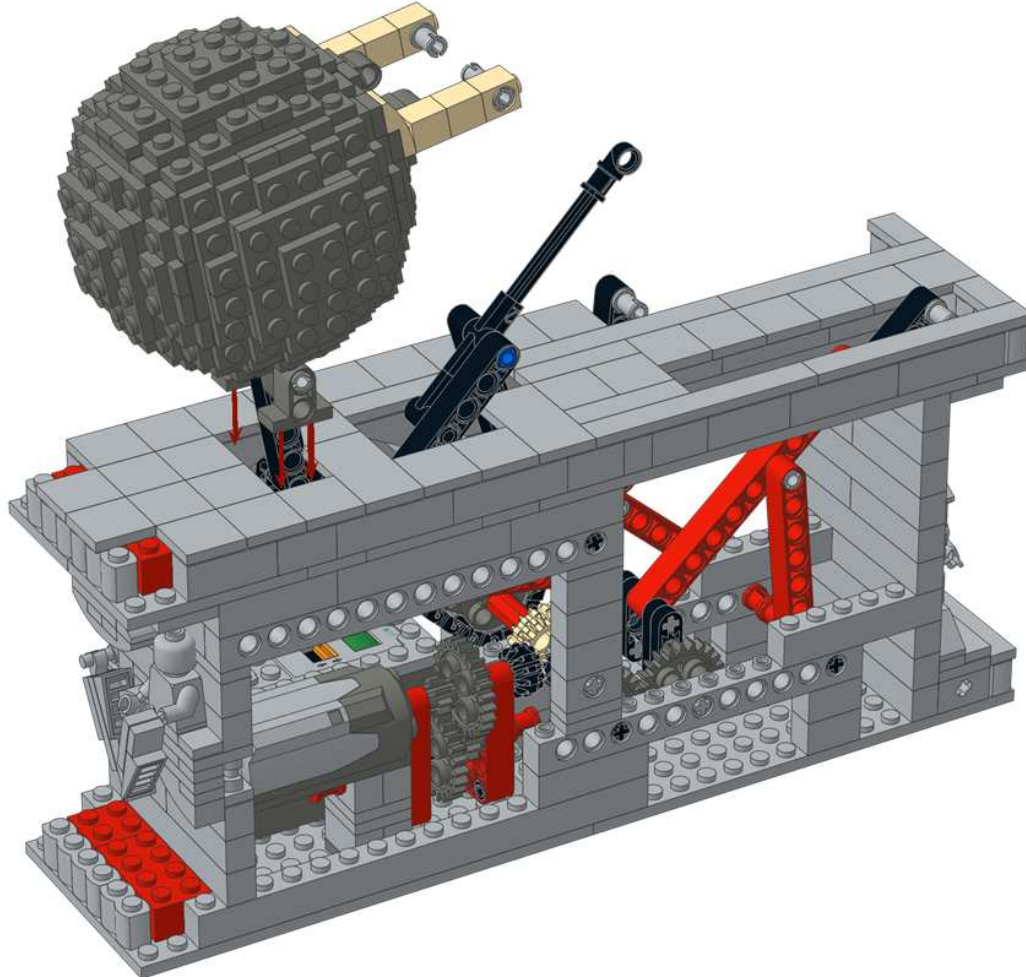

○

2

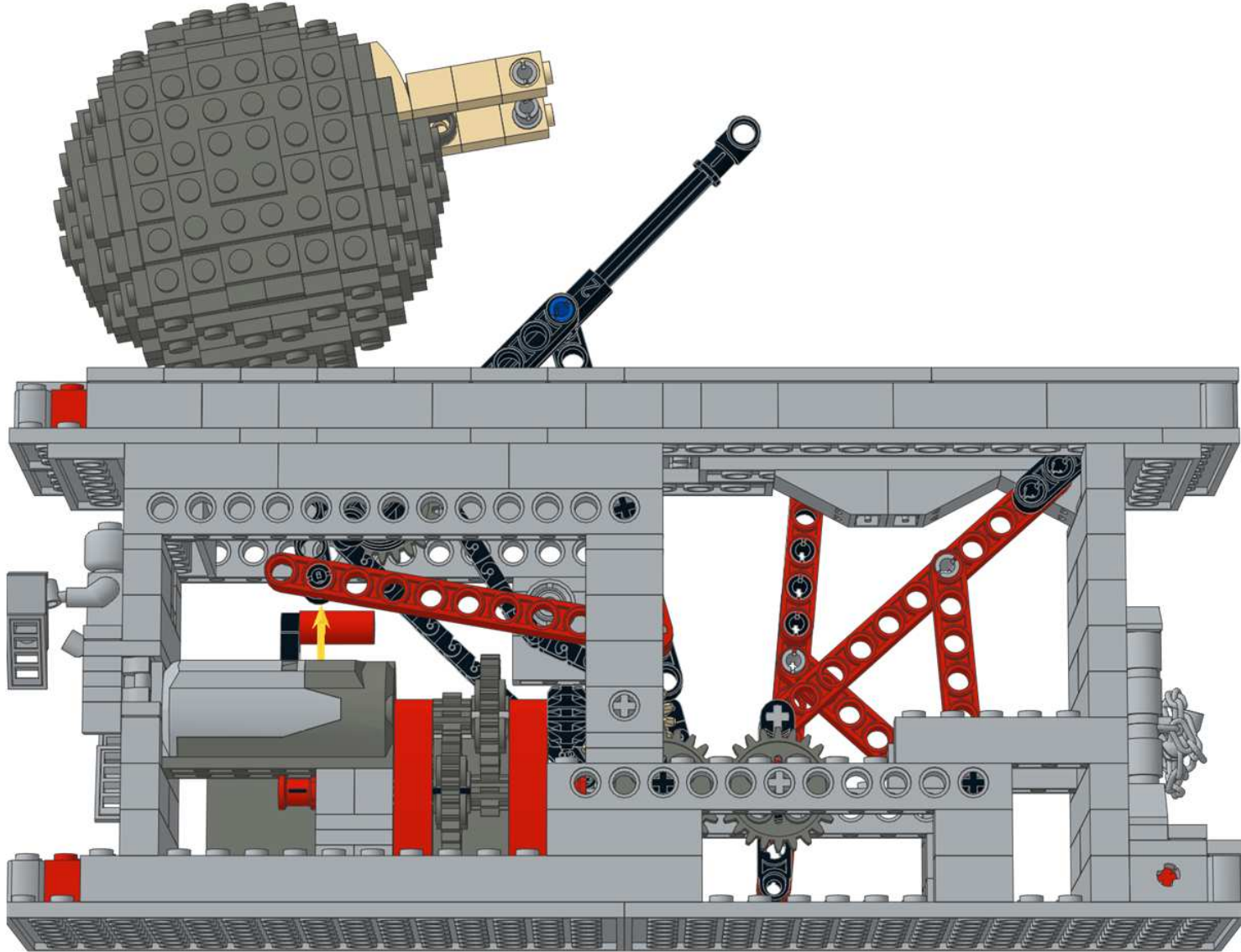

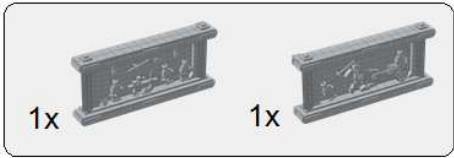

3

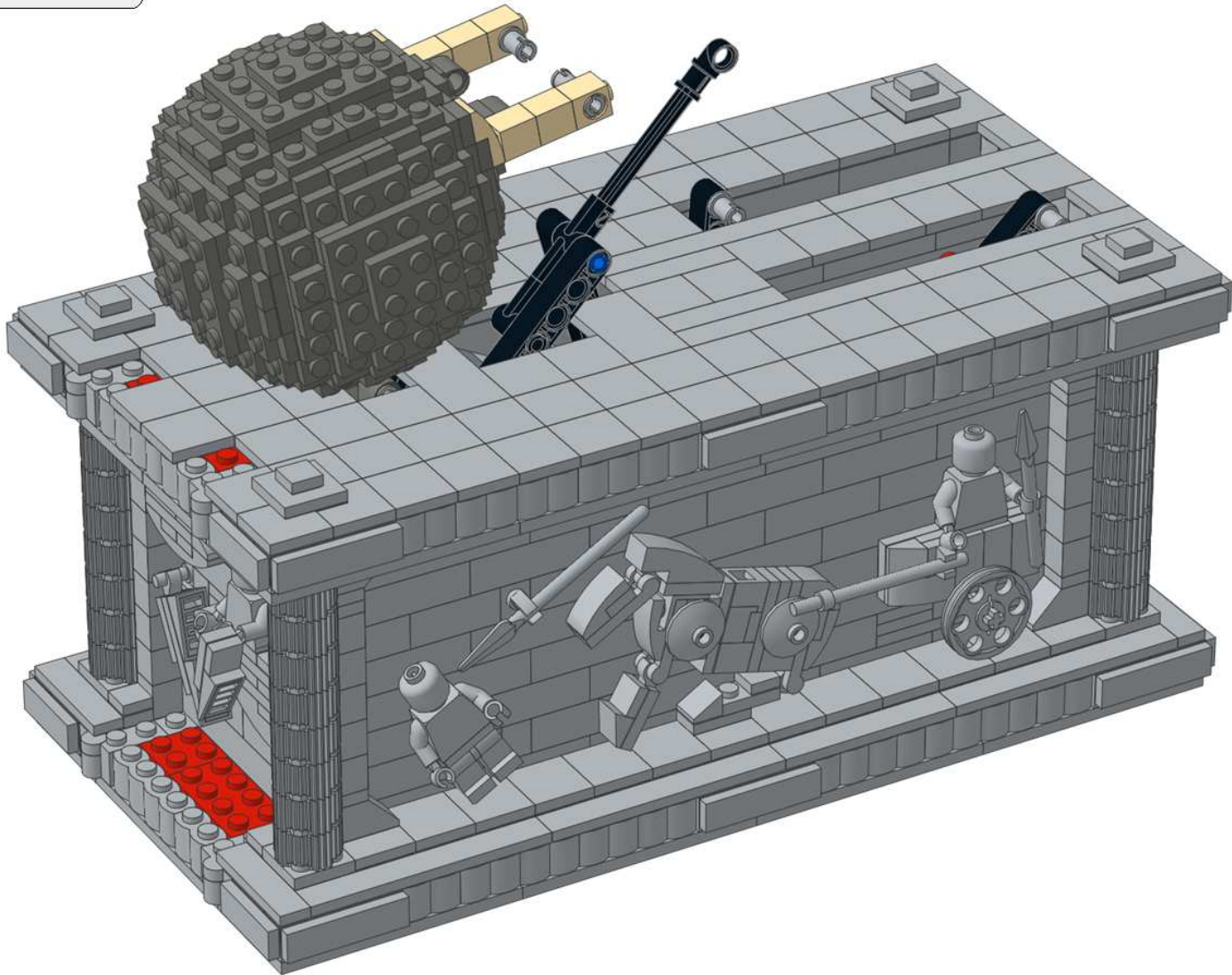

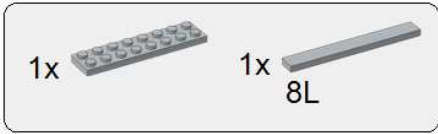

4

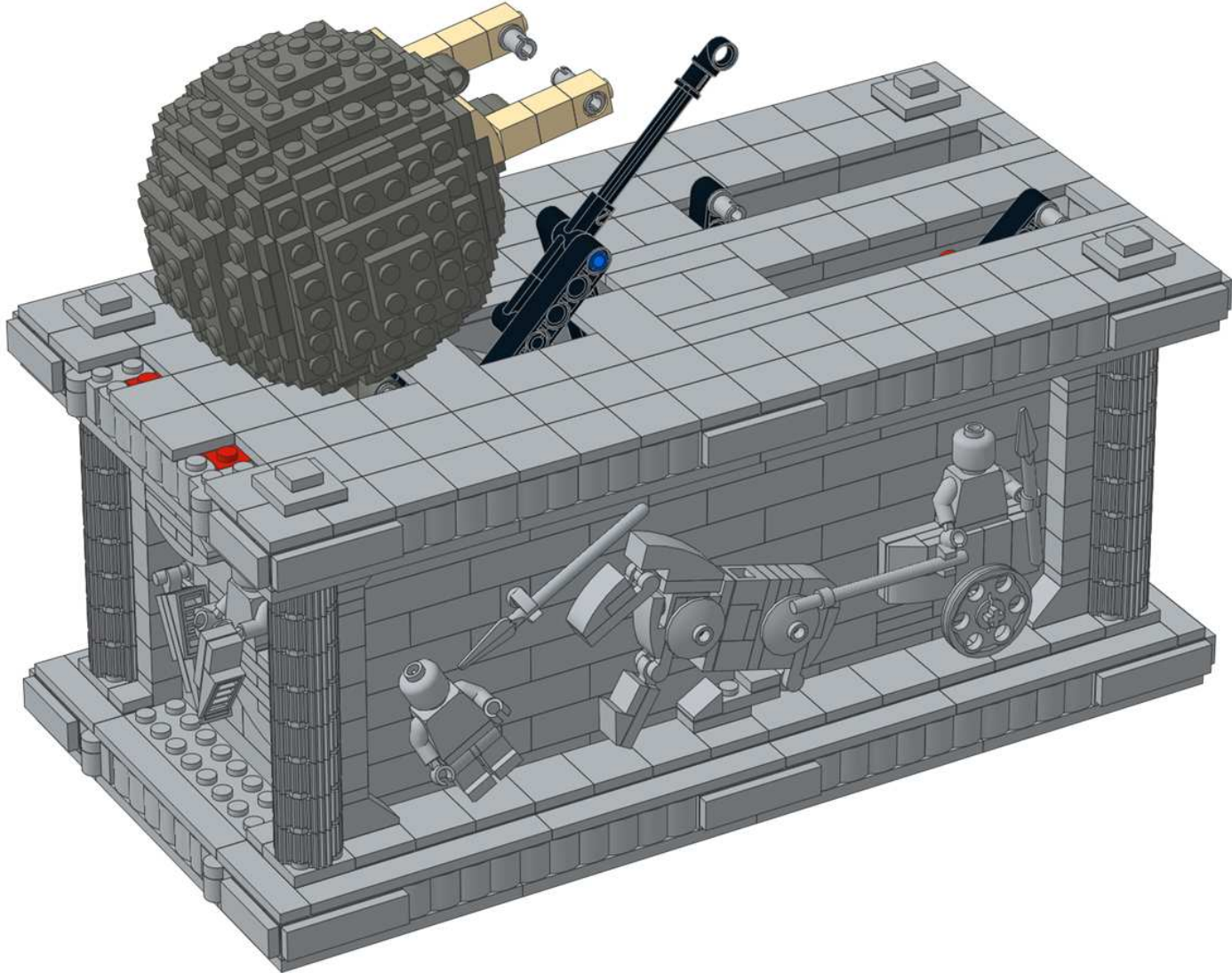

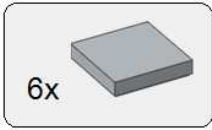

5

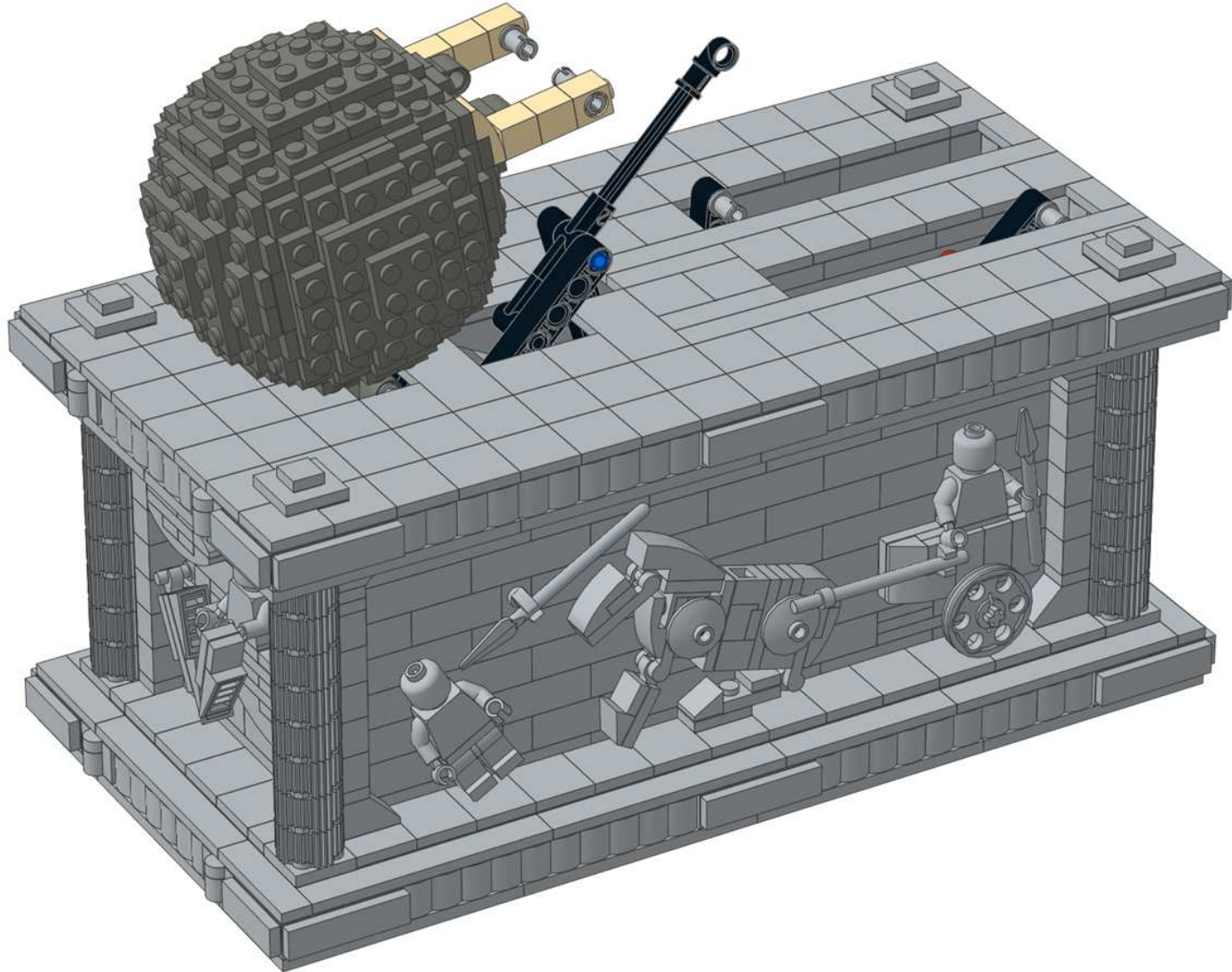

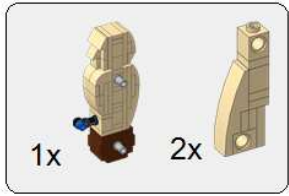

6

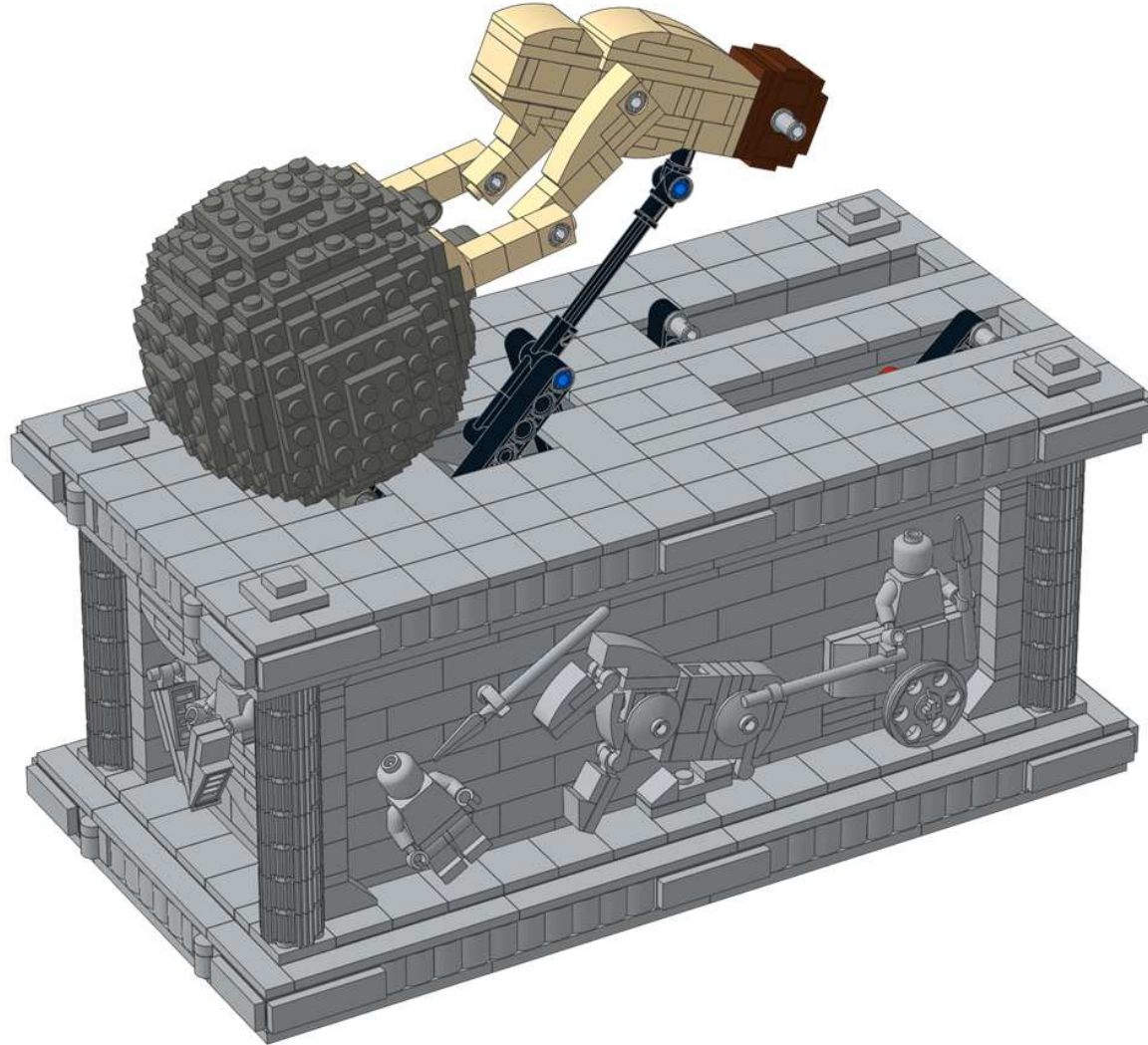

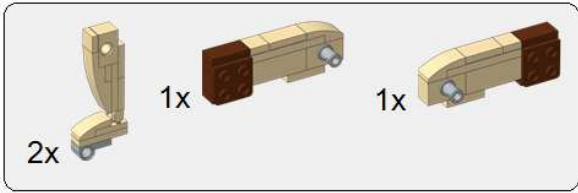

7

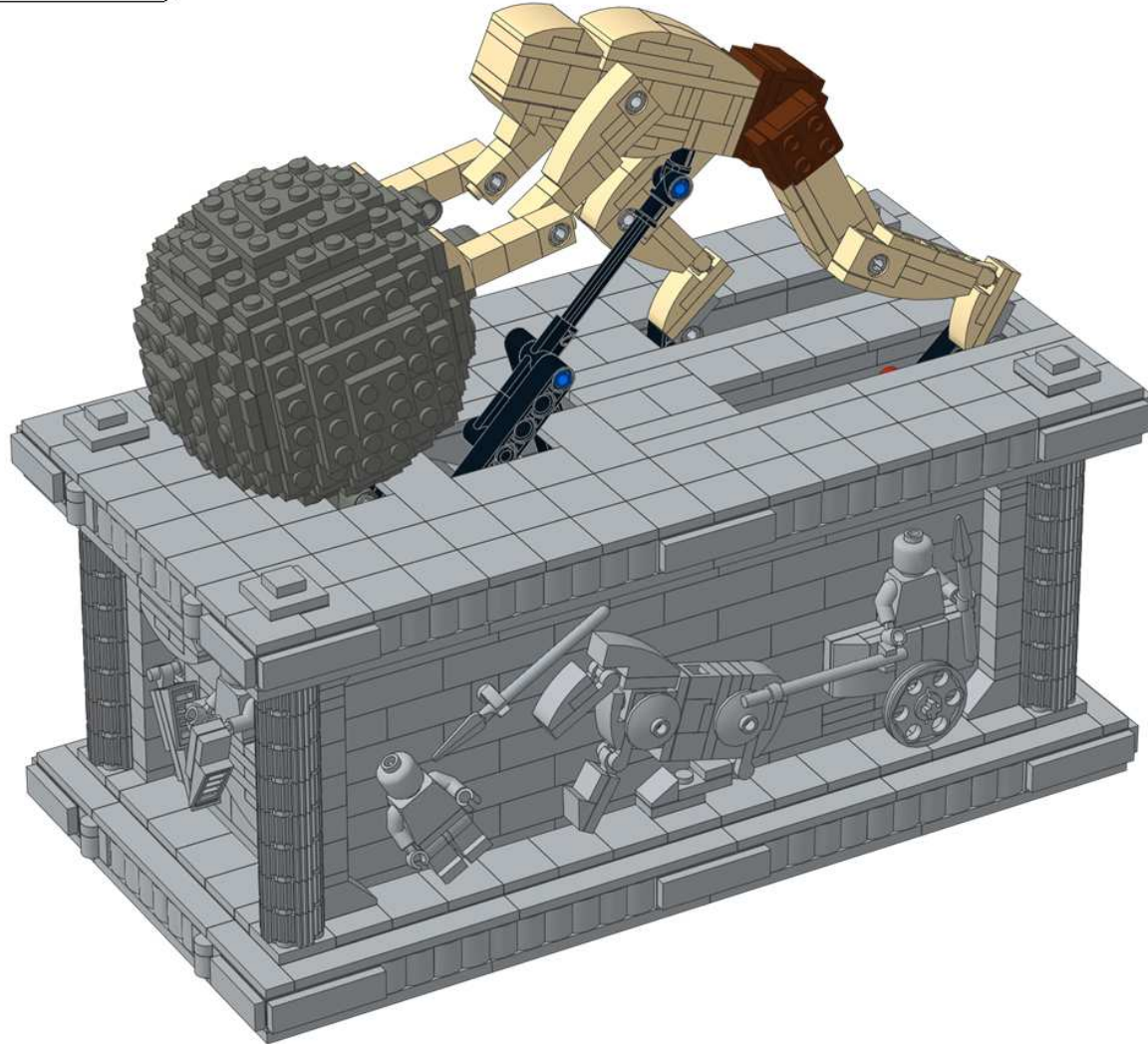

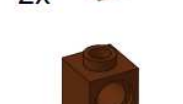
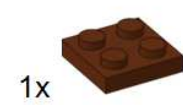
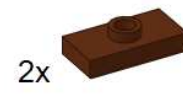
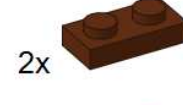
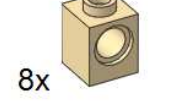
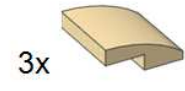
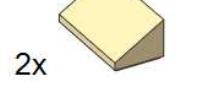
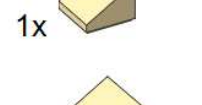
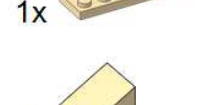
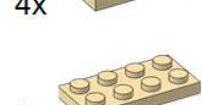
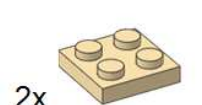
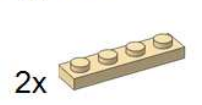
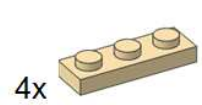
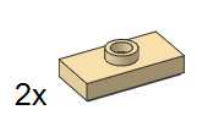
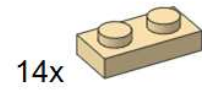
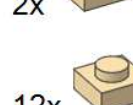
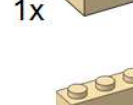
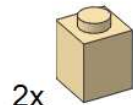
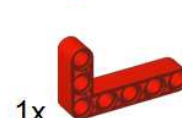

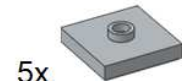
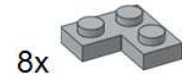
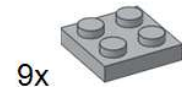
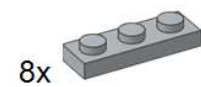
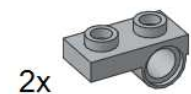
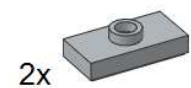
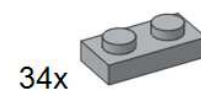
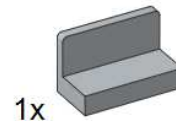
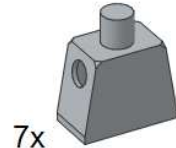
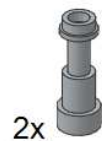
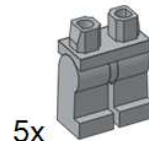
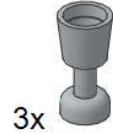
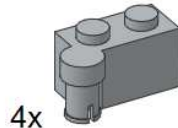
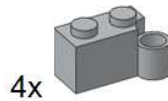
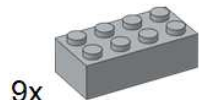
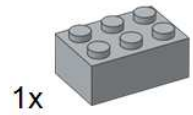
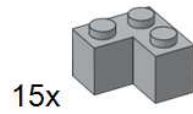
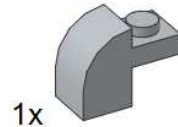
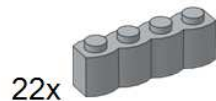
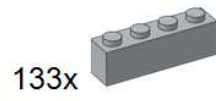
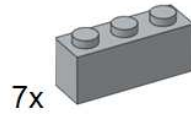
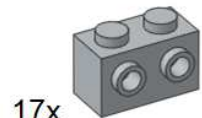
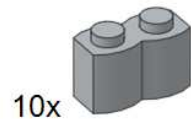
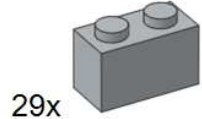
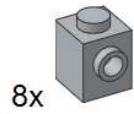
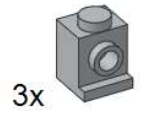
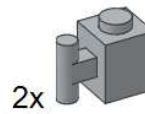
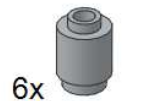
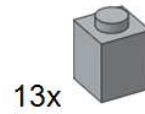
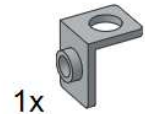

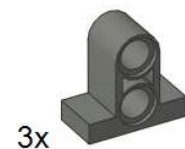
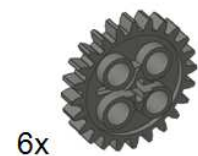
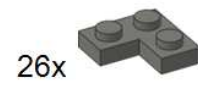
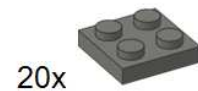
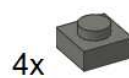
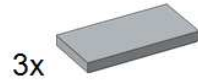
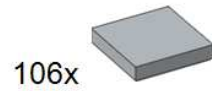
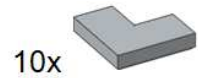
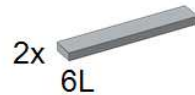
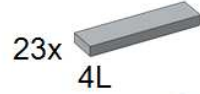
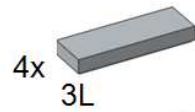
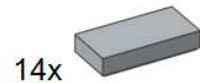
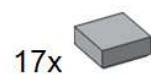
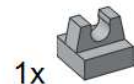
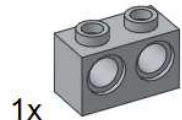
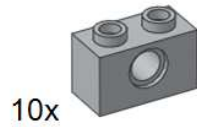
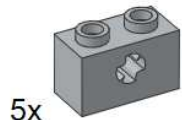
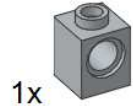
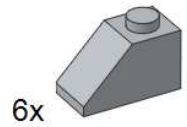
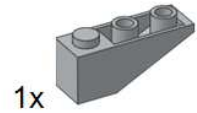
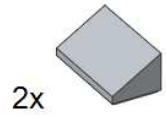
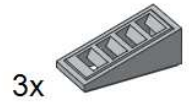

1518 Sisyphus

A custom model design by Jason Allemann

Copyright © 2015

To see more of our models, visit jkbrickworks.com

These instructions were created using the LDraw system of tools.
For more information, visit ldraw.org. Publishing was done using
Instructor version 1.6

These instructions and the model they depict are in no way
sponsored, endorsed, or authorized by The LEGO Group.