

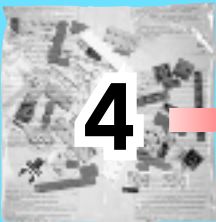

10230

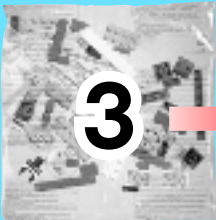

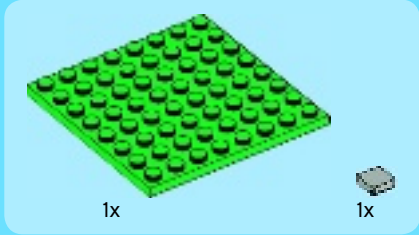

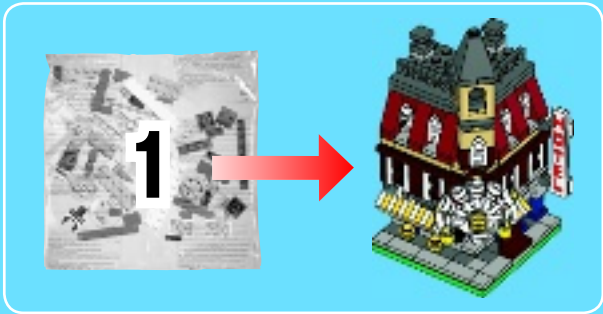

1

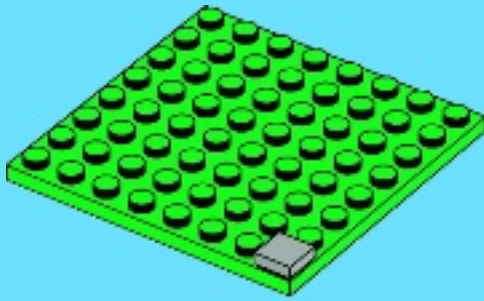

2

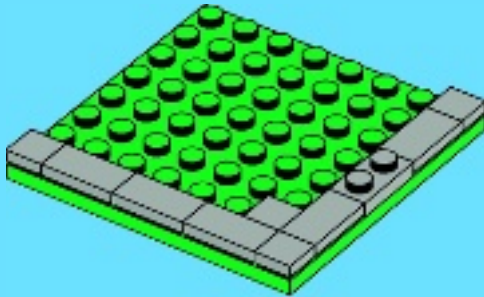



2x



2x



8x

# 3

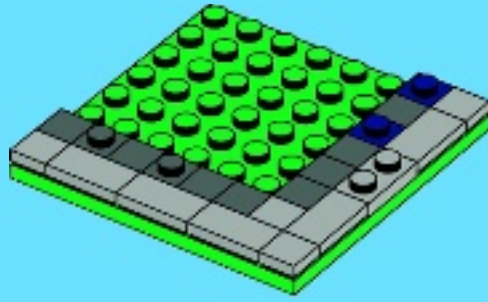

1x



1x



1x



2x

# 4

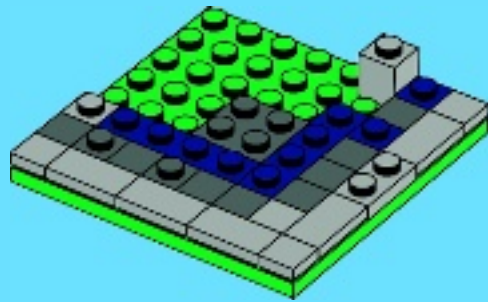

2x



5x



4x



1x

# 5

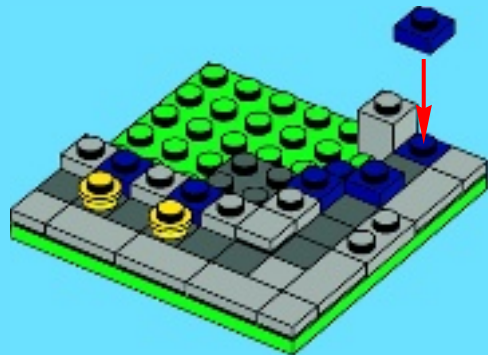

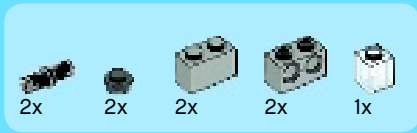

6

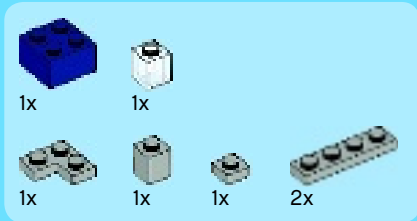
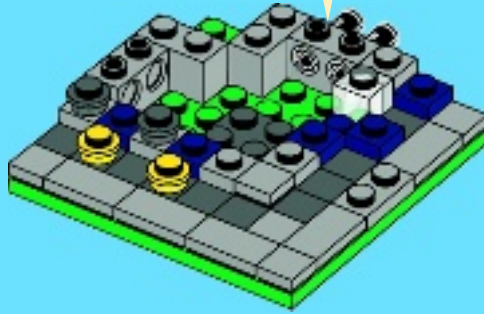
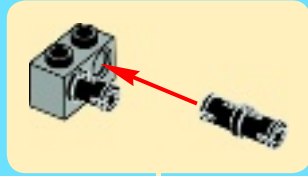

7

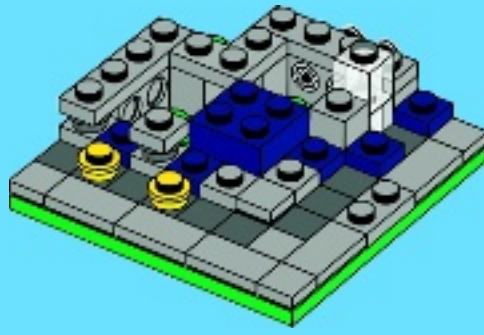



8

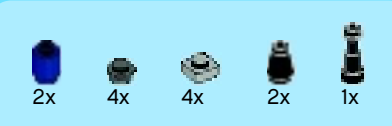
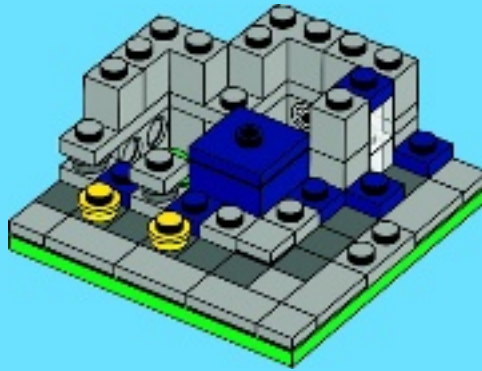

9

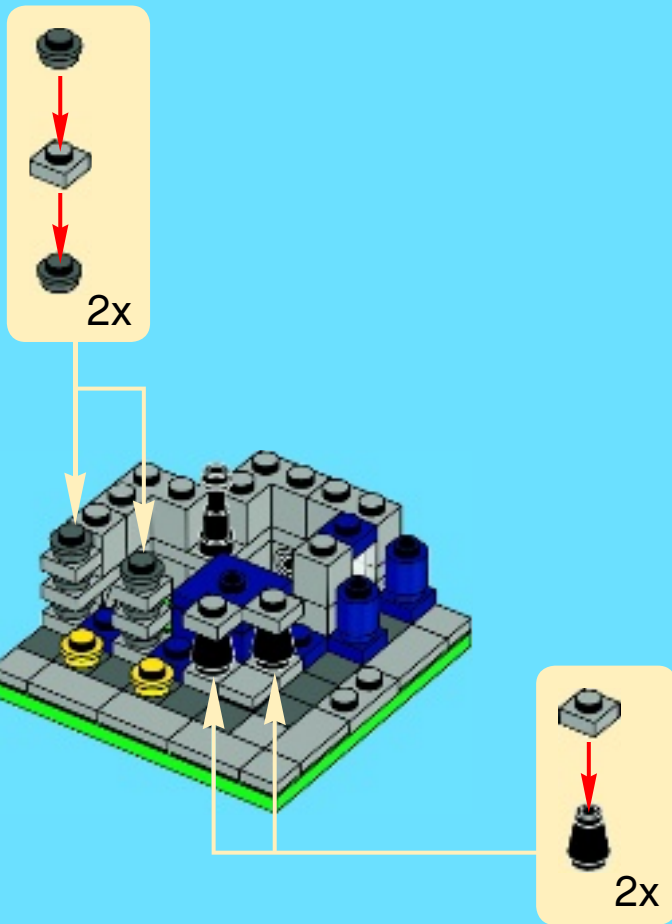

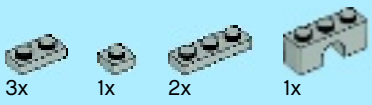

10

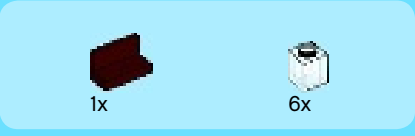
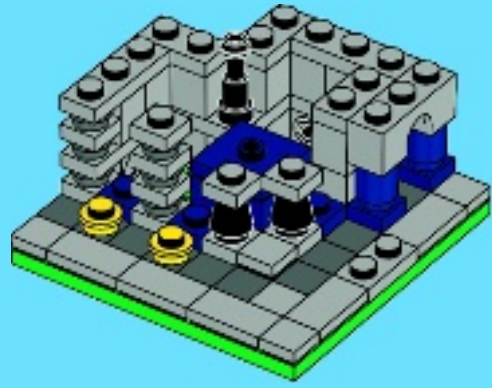

11

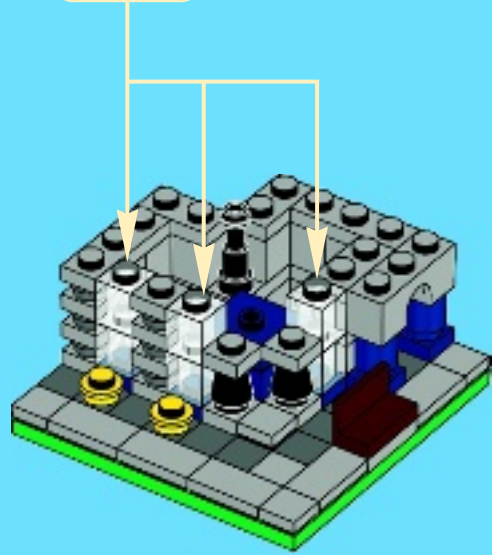
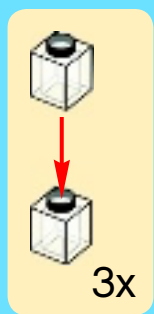

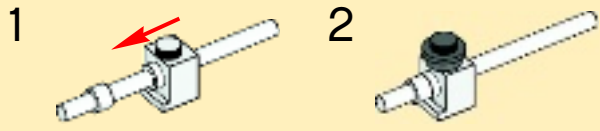
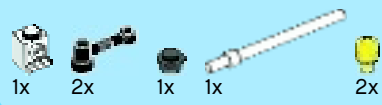

12

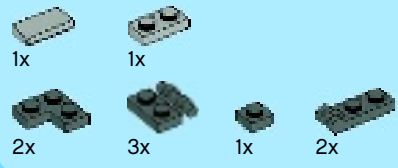
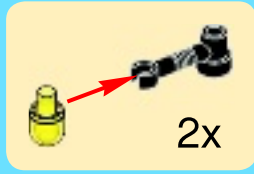
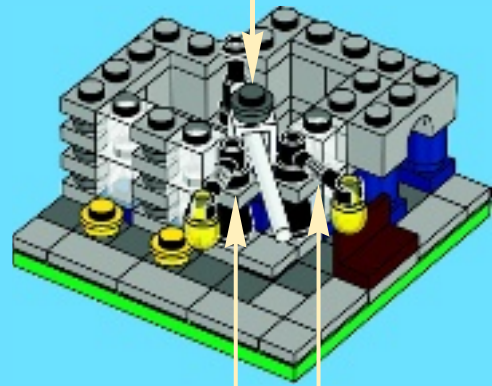

13

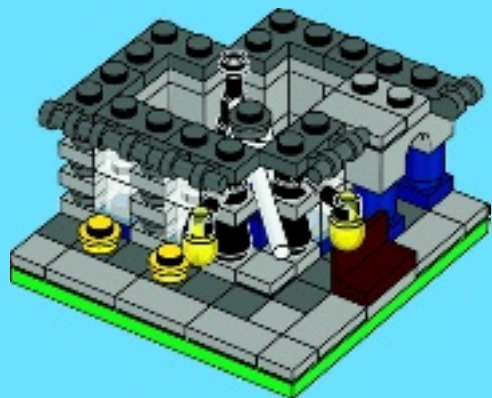



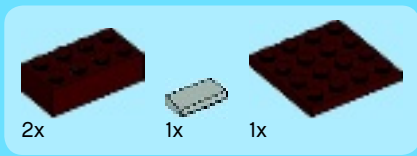

# 14

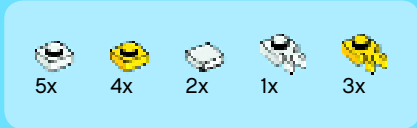
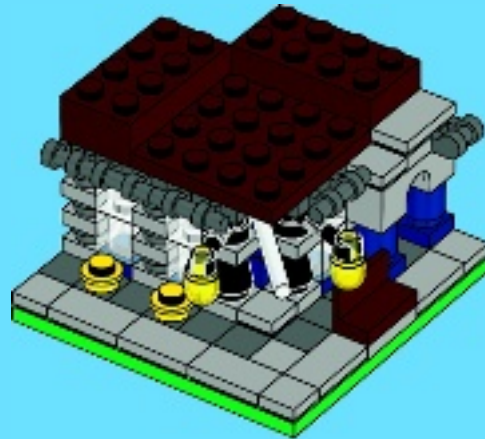

# 15

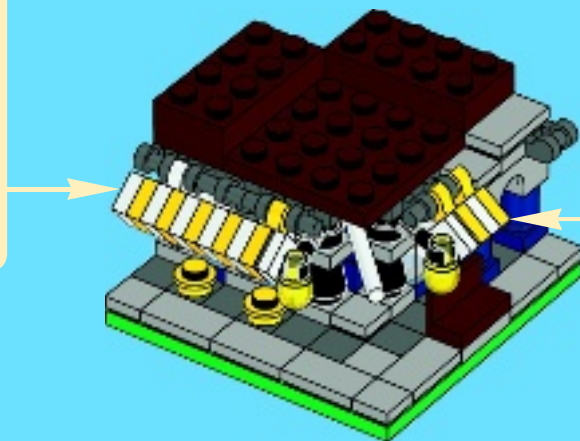
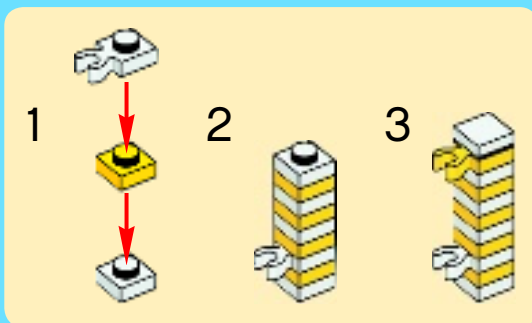

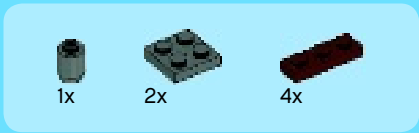

16

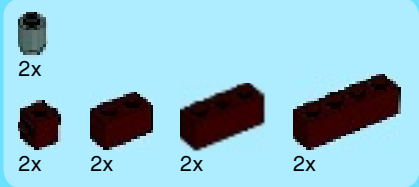
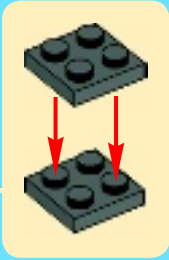
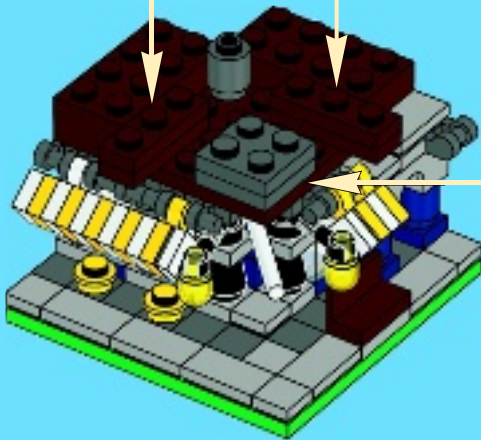
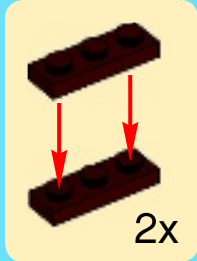

17

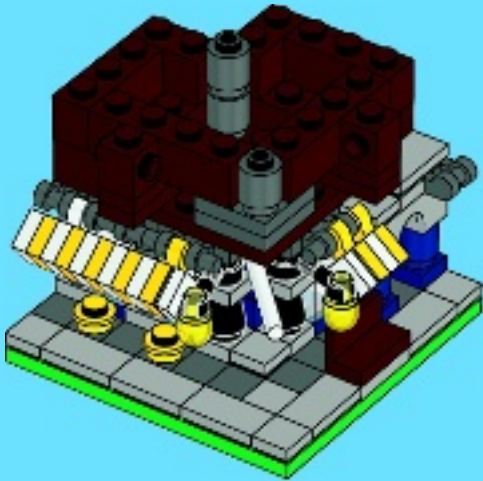



8x



4x



16x

# 18

1



2



3

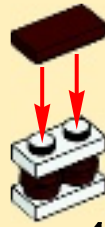

4x

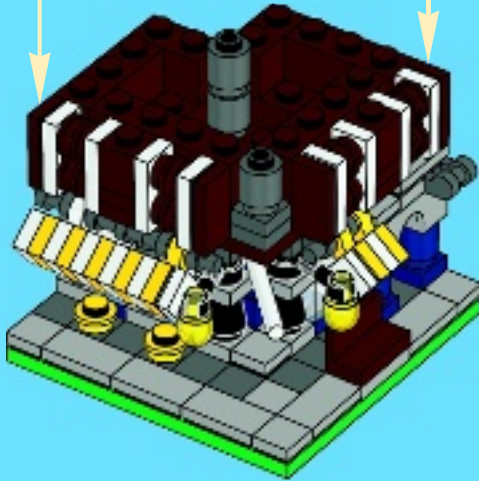

2x



1x



2x

# 19

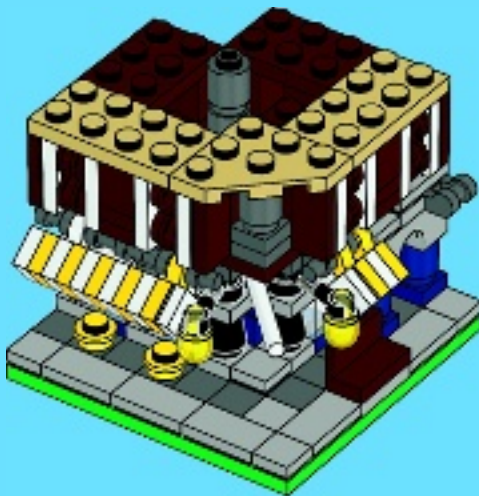

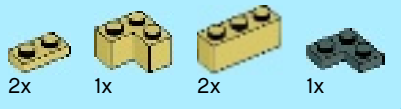

20

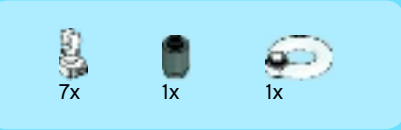
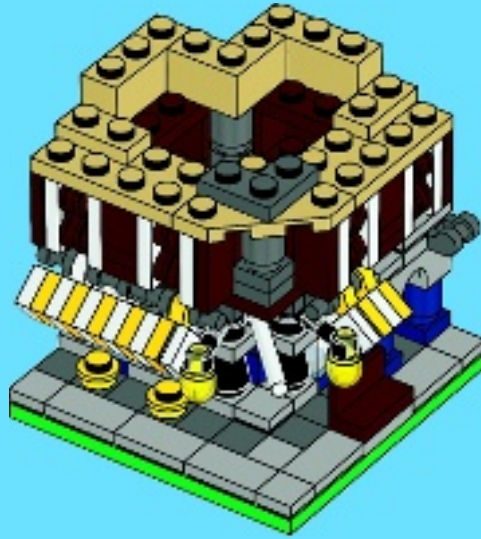

21

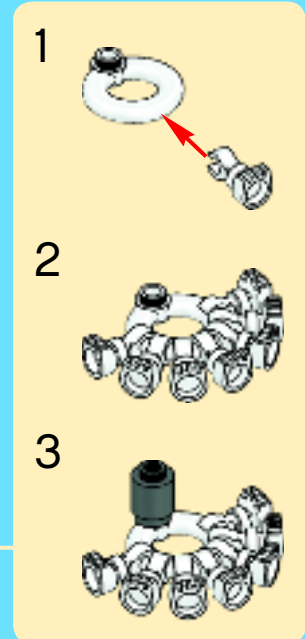
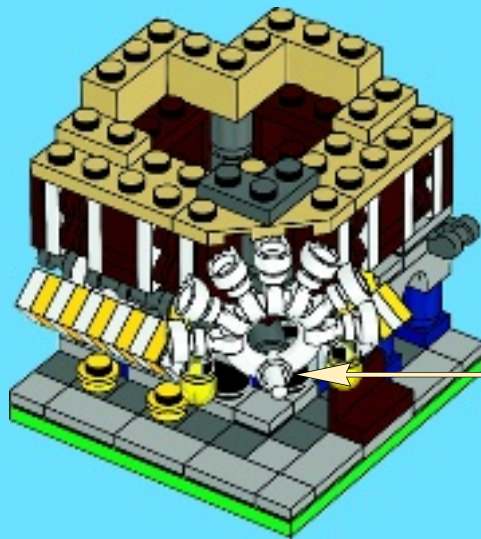



22

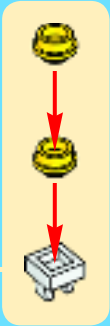
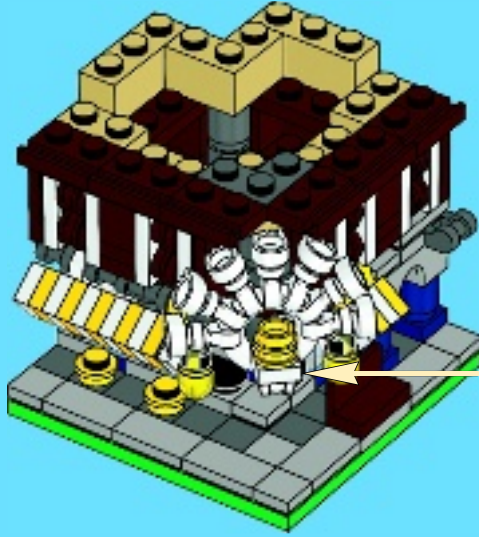

23

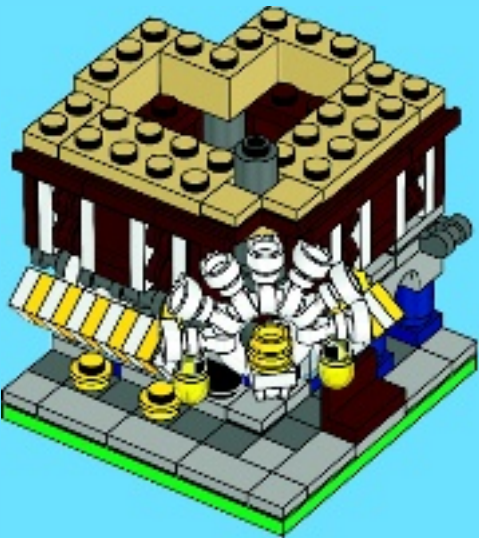



24

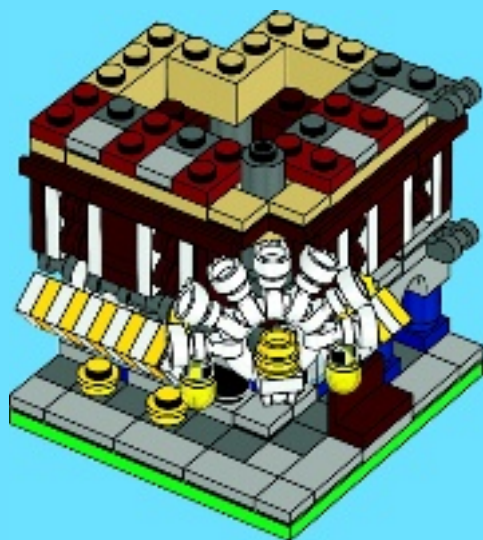

25

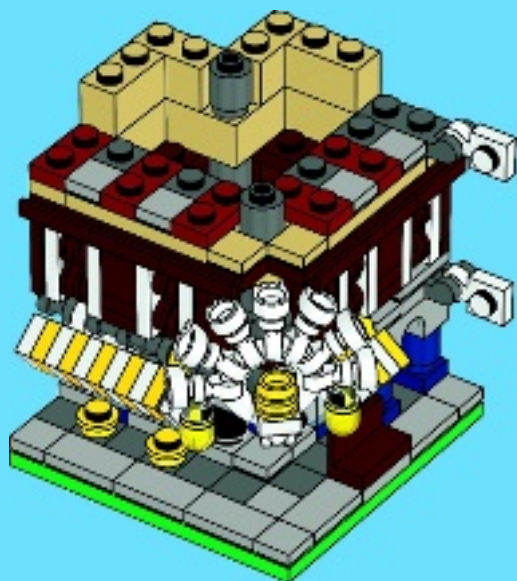



1x



2x



6x

# 26

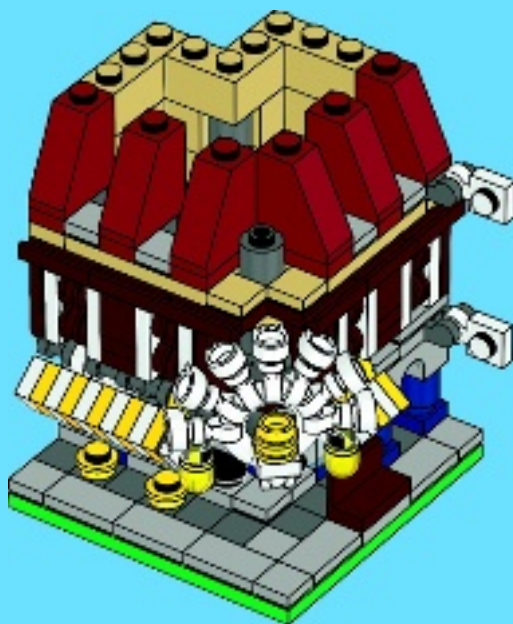

4x



4x



1x



4x

# 27

1



2



4x

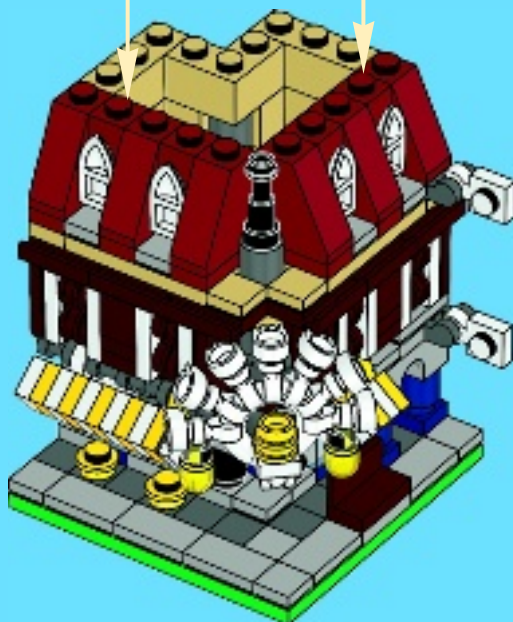

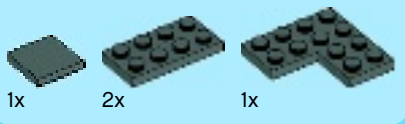

28

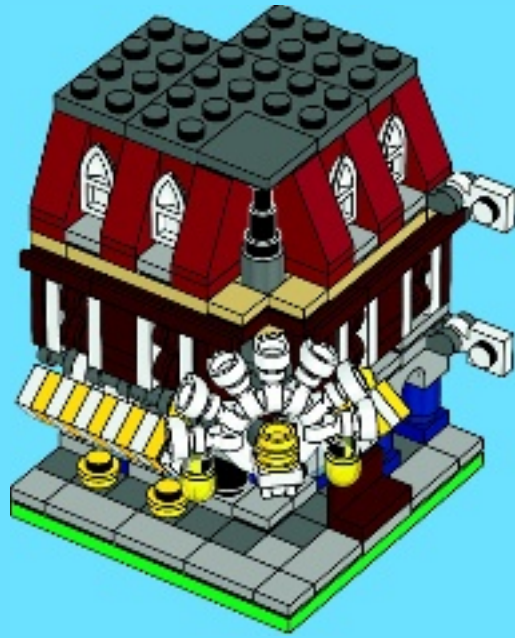

29

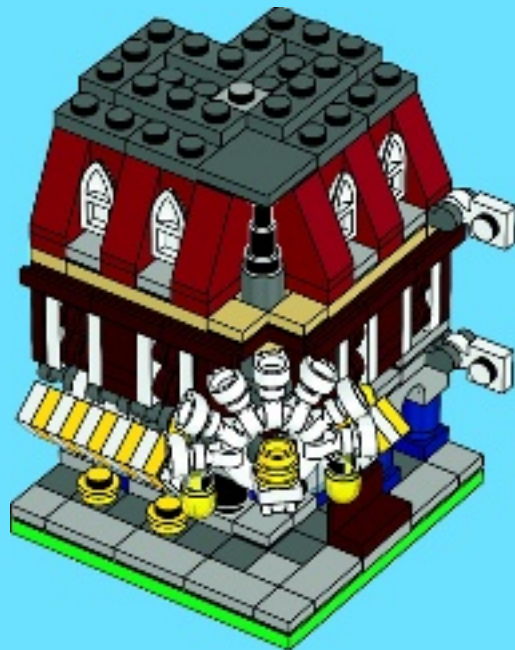



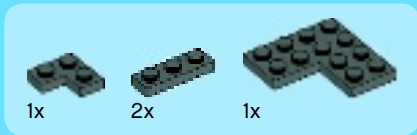

30

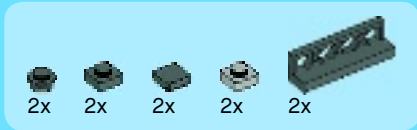
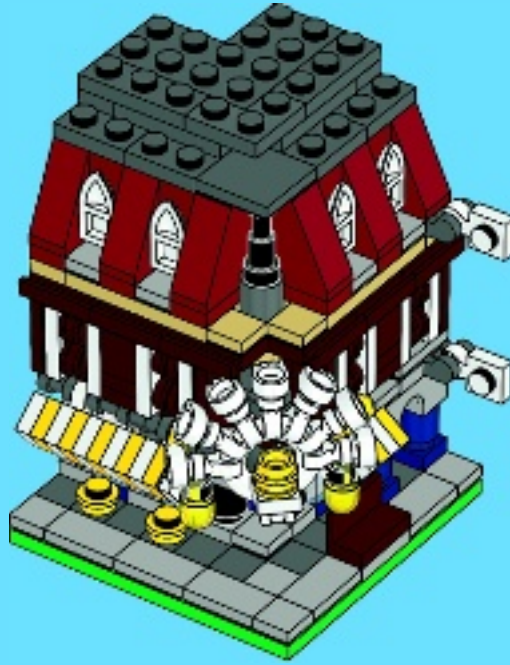

31

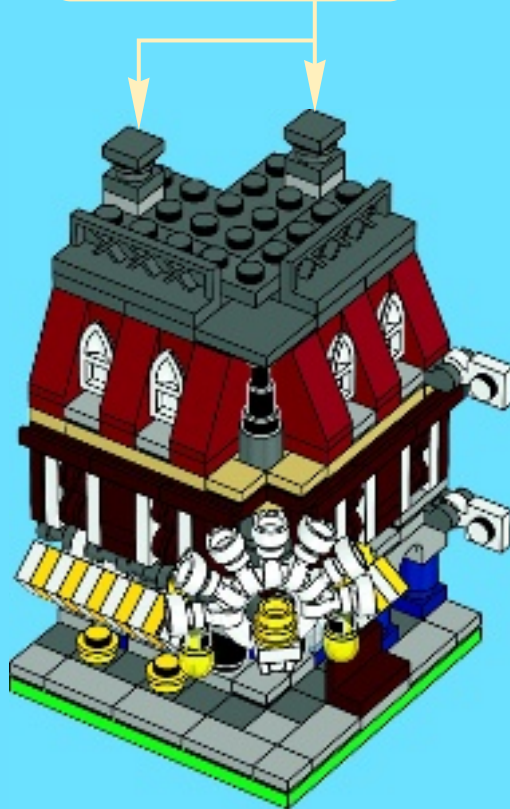
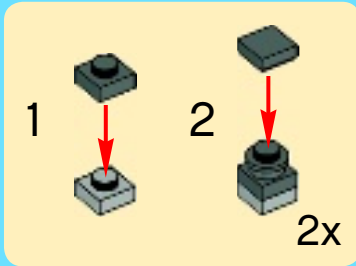



2x



1x



1x

# 32

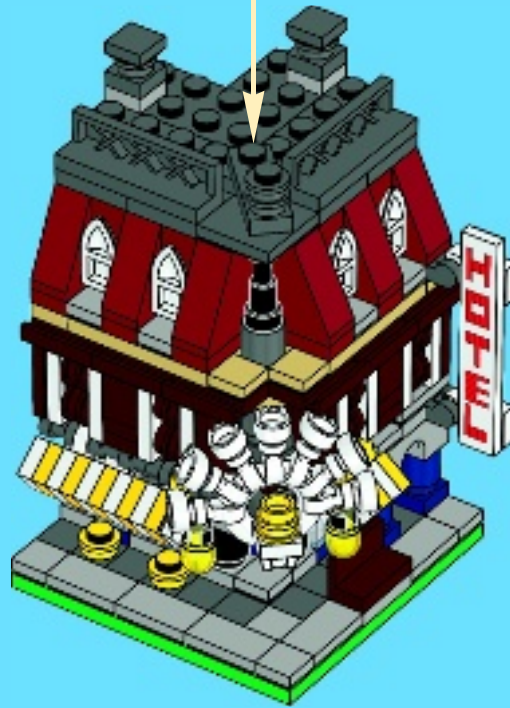
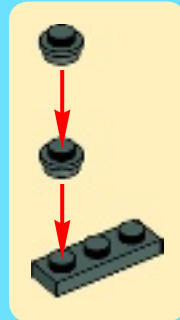



1x



1x

1

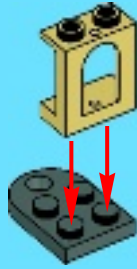

1x

2



2x

3



1x

4



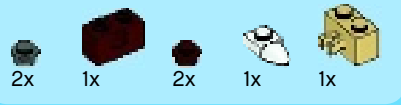

5

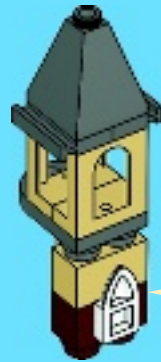
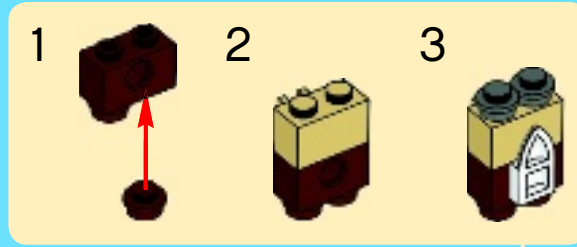

33





2

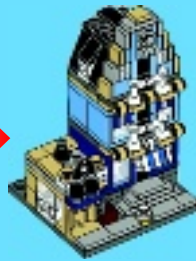

1x



1x

1



1x



1x



2x



3x

2

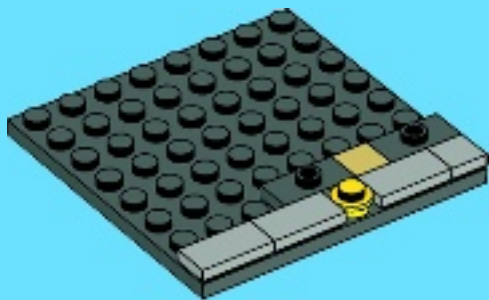

1x



1x



2x



1x



1x



2x

3

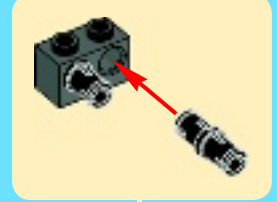
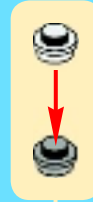

1x



1x



2x

4

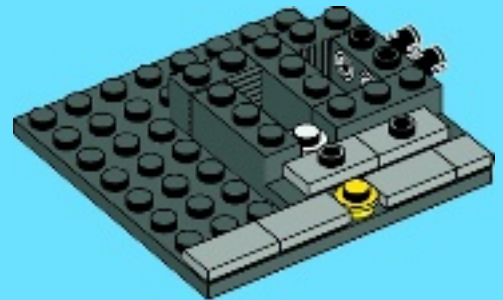



1x



1x



1x

5

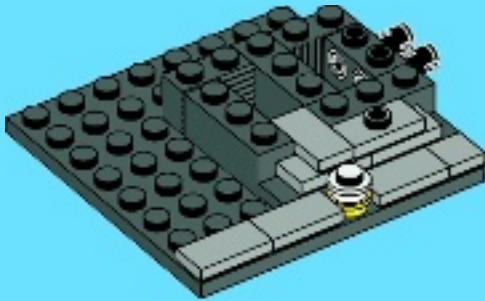

1x



1x



2x

7

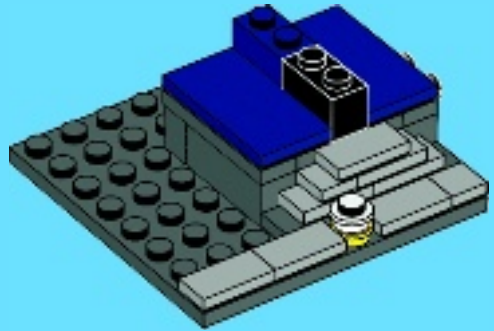

2x



2x



1x

6

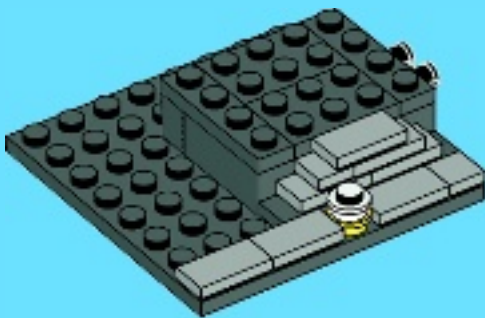

3x



1x

8

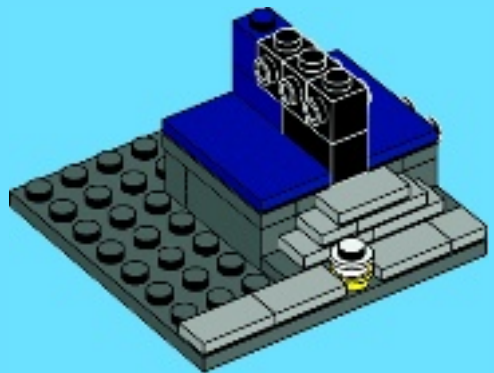

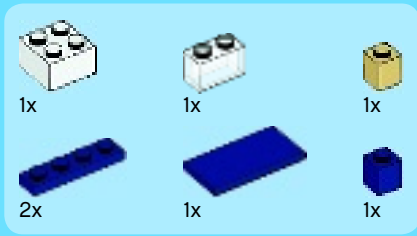

9

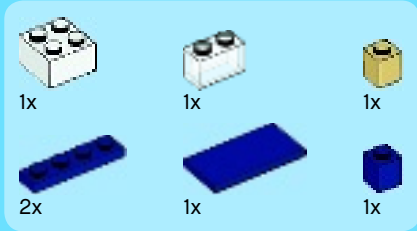
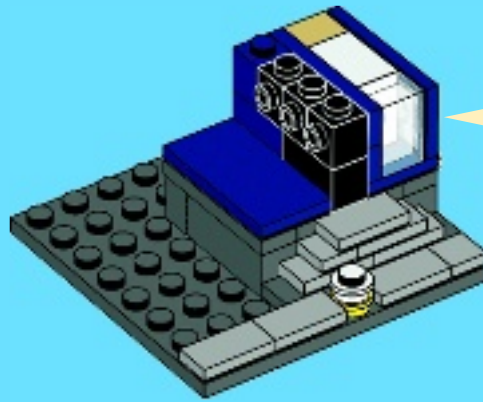

10

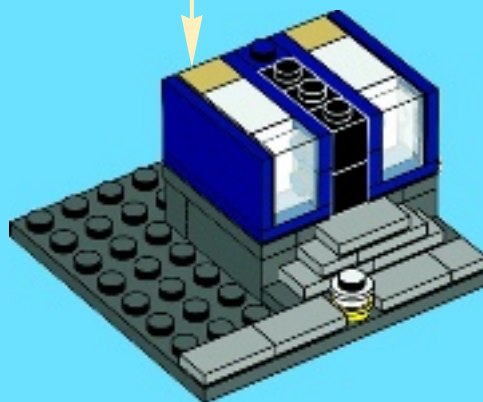



4x



1x



1x



1x

# 11

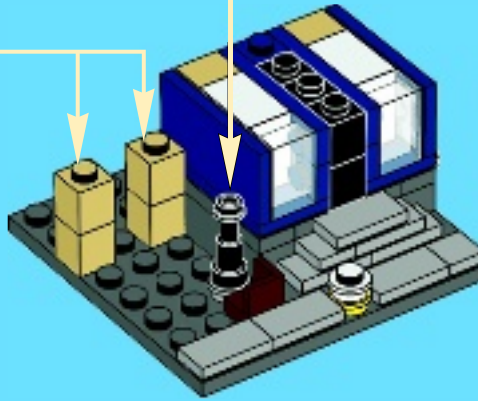
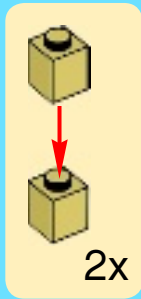

1x



1x



2x

# 12

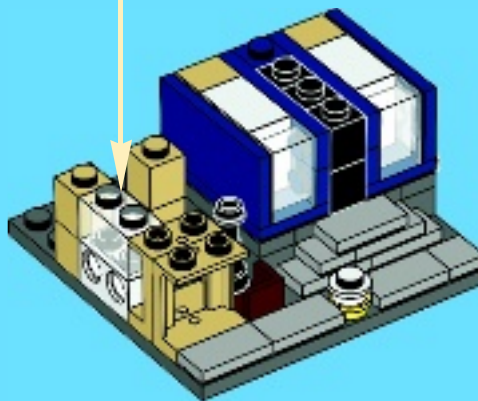
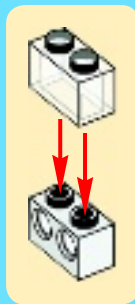





2x



1x



1x

# 13

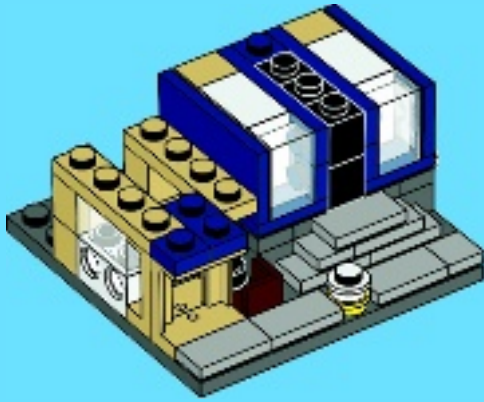

1x



2x



1x

# 15

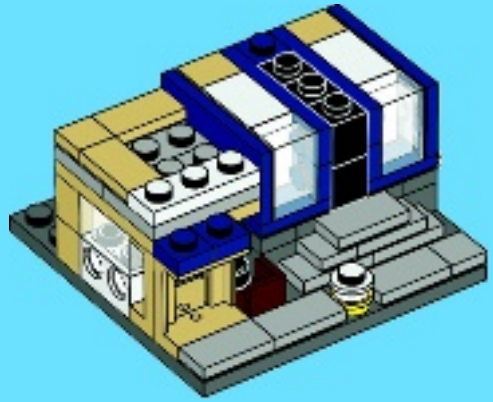

2x

# 14

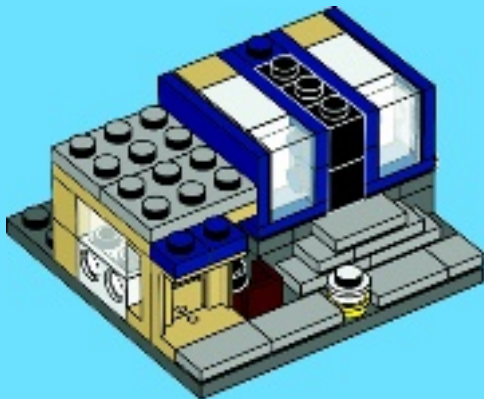

2x



3x



2x



2x



2x

# 16

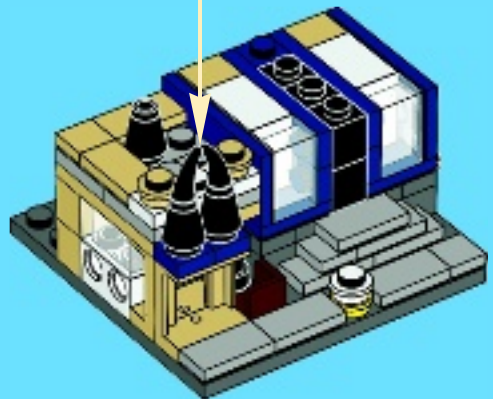



1



2

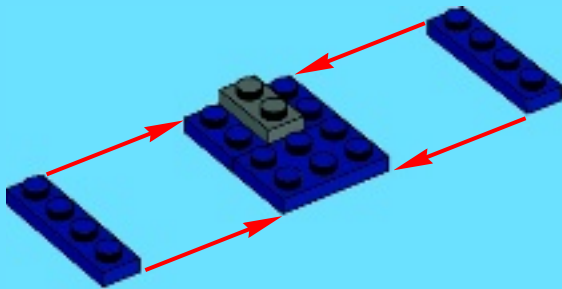

3



4



5

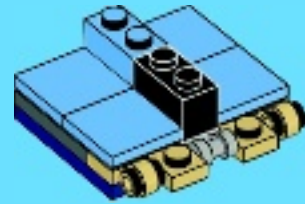

6

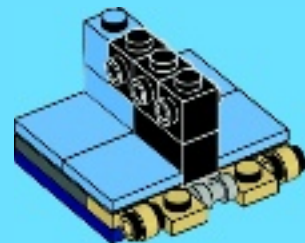



2x

1



1x



1x



1x

2

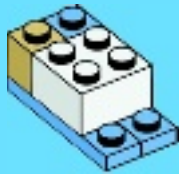

2x



1x



1x

3

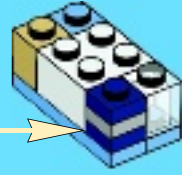
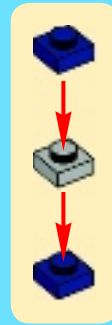

2x

4

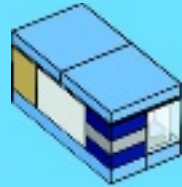

7

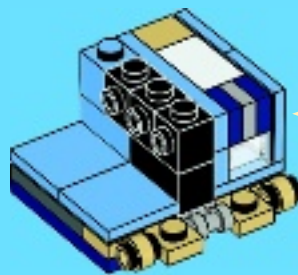

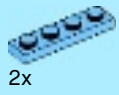

2x

1



1x



1x



1x

2

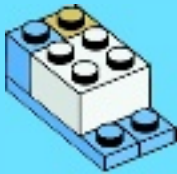

2x



1x



1x

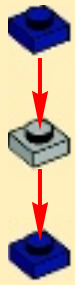

3

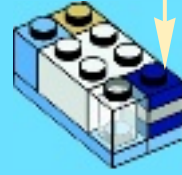

2x

4

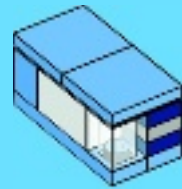

8

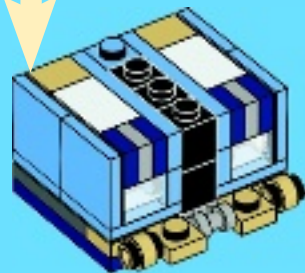



2x

# 17

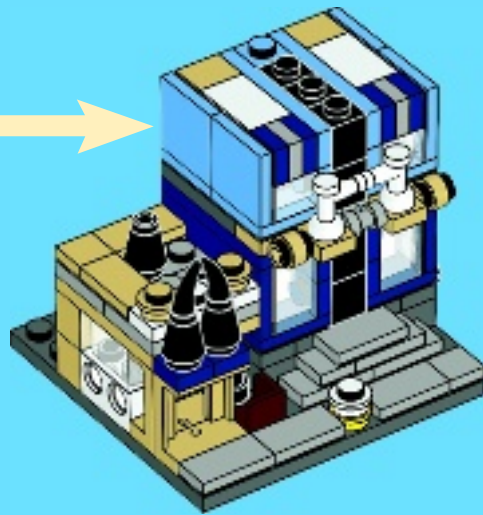

1x



2x



1x



1x

# 18

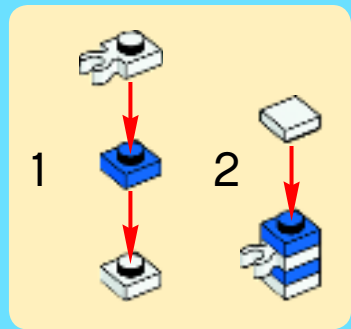



1



2

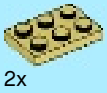
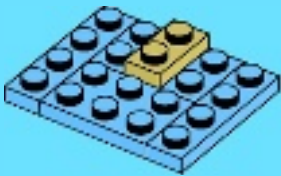

3



4



5



6

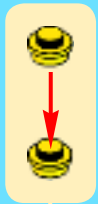
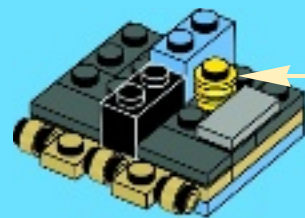



7

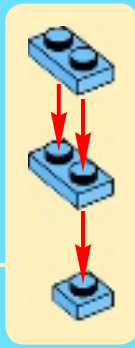
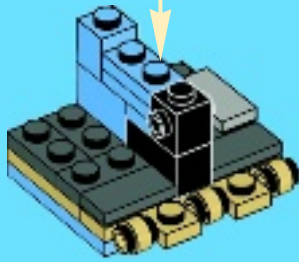

10



8

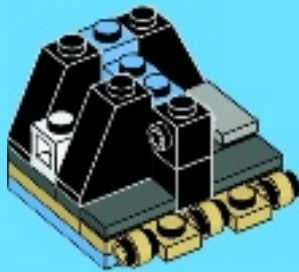

11

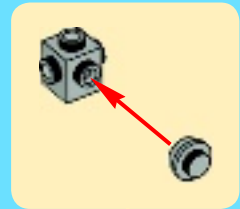

9

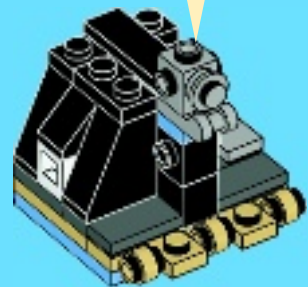
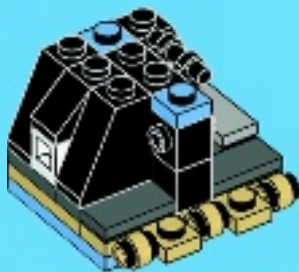



12

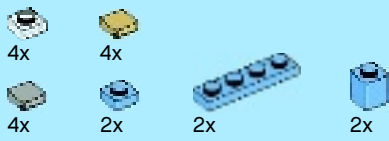
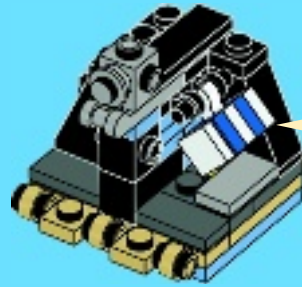
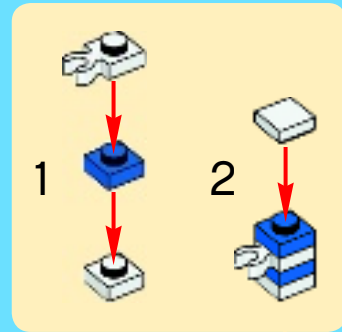

13

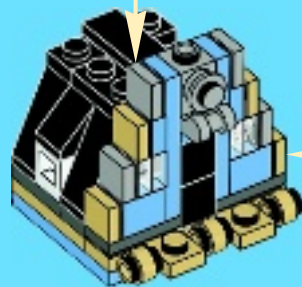
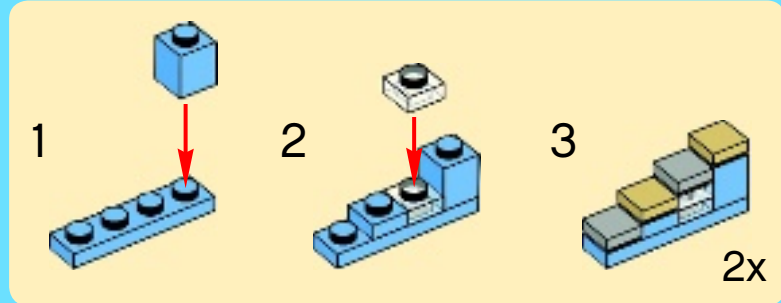





2x



1x



1x

14

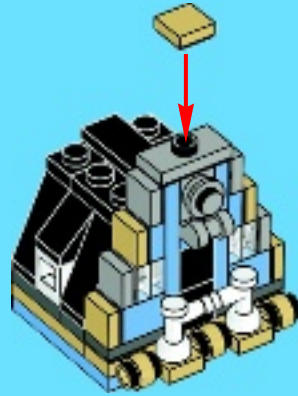

19



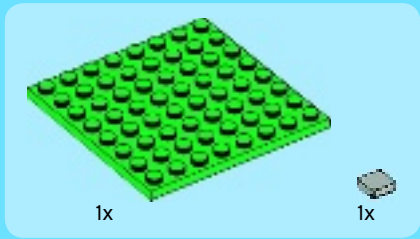
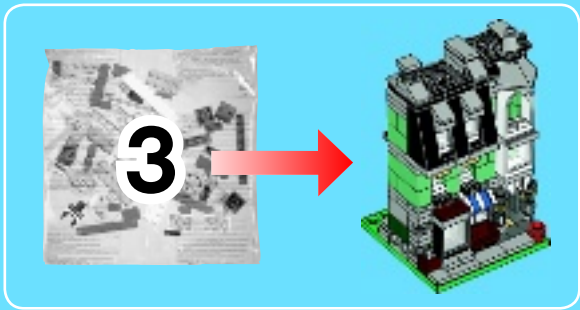

1

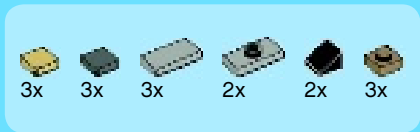
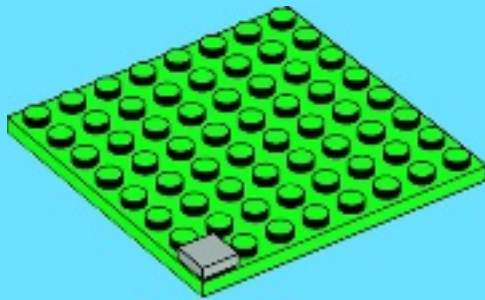

2

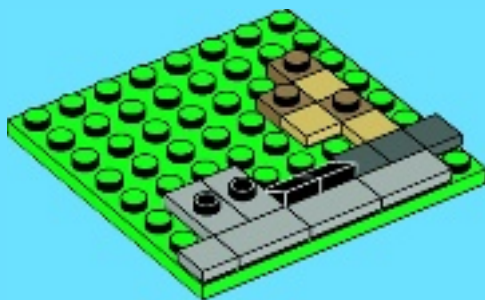



3

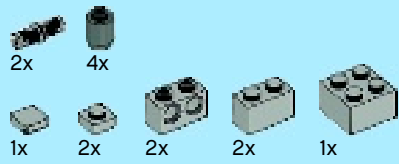
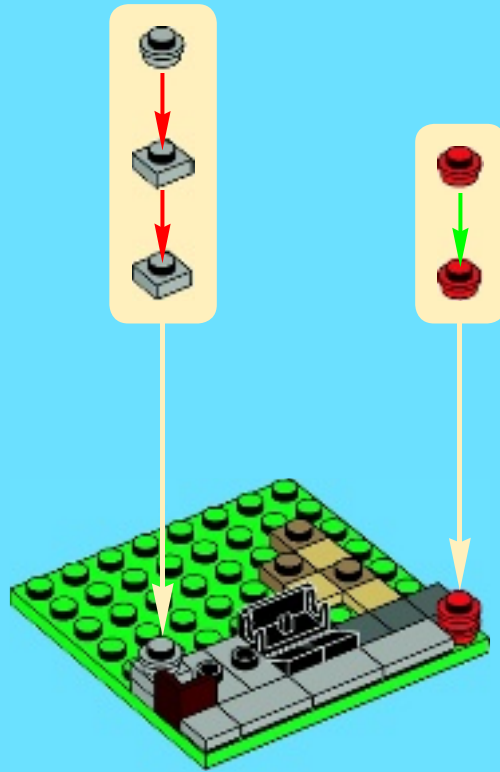

4

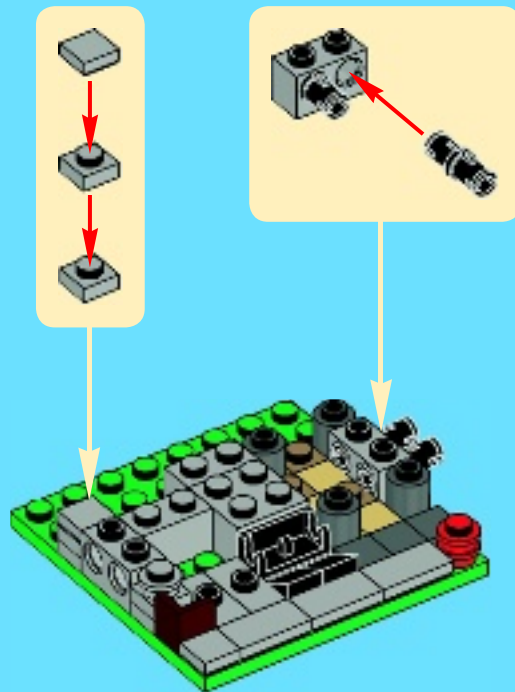



5

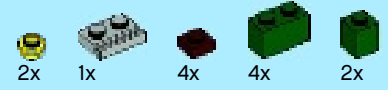
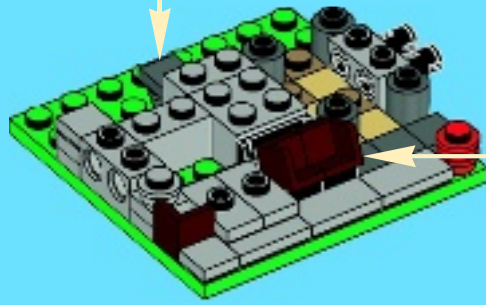
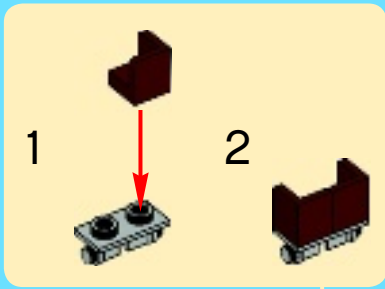
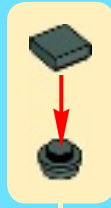

6

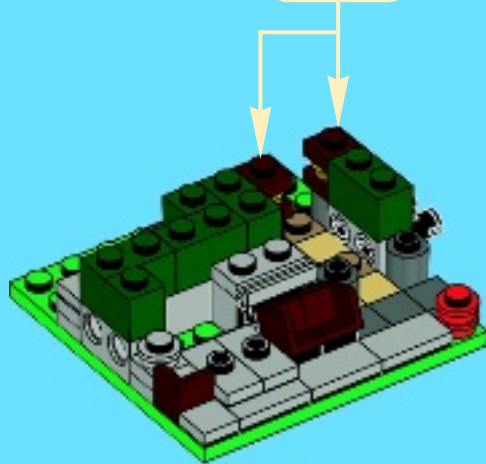



2x



2x



1x



2x

# 7

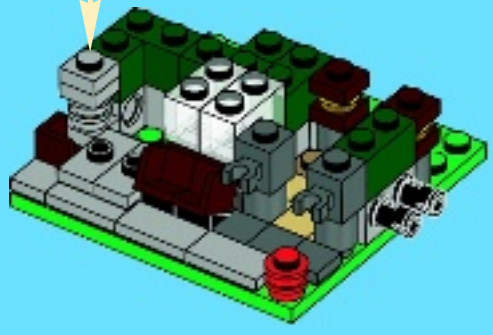
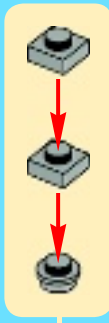

2x



1x



1x



2x



1x



1x



1x

# 8

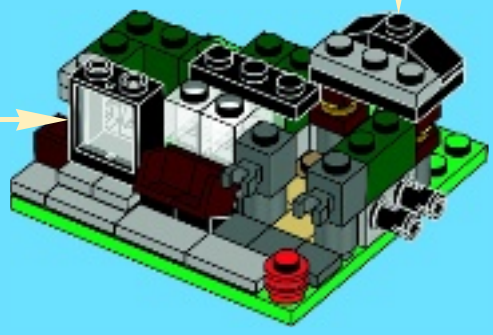
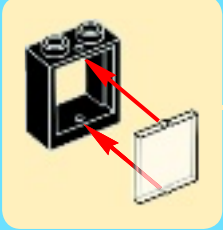
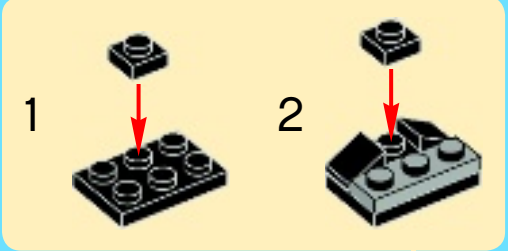

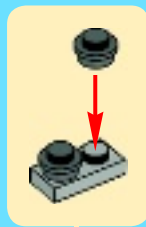
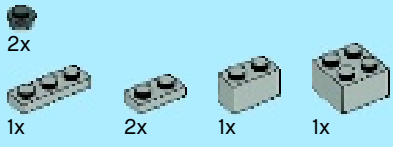

9

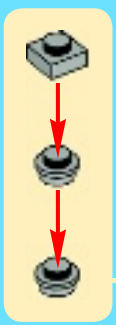
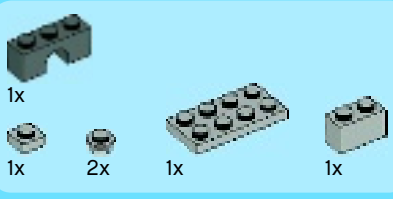
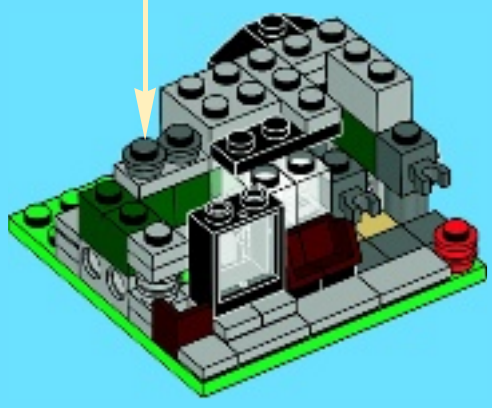

10

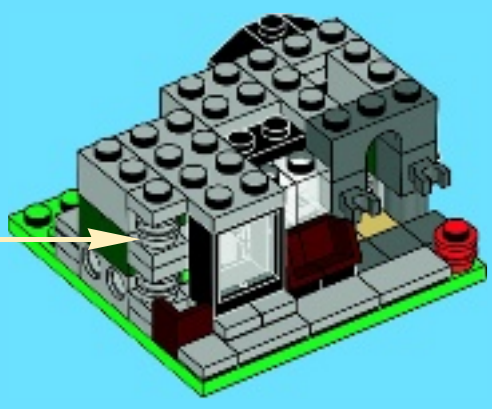



2x



2x



2x

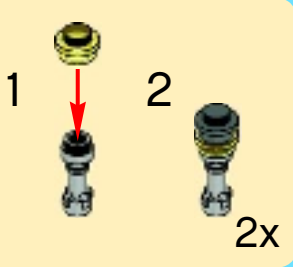

# 11

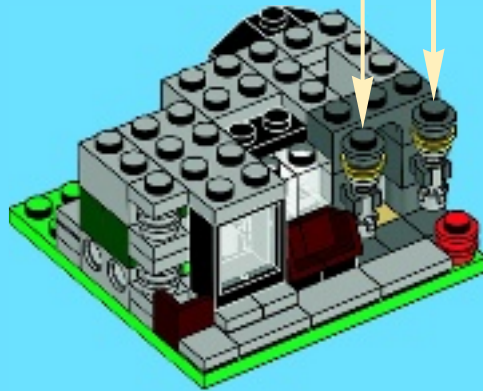

2x



1x



1x



2x

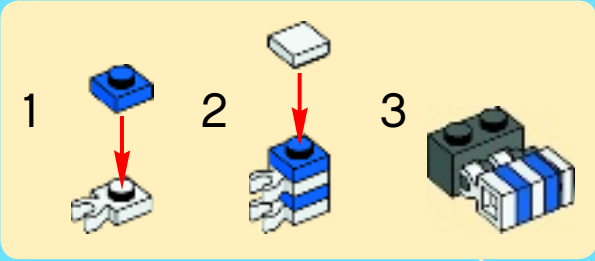

# 12

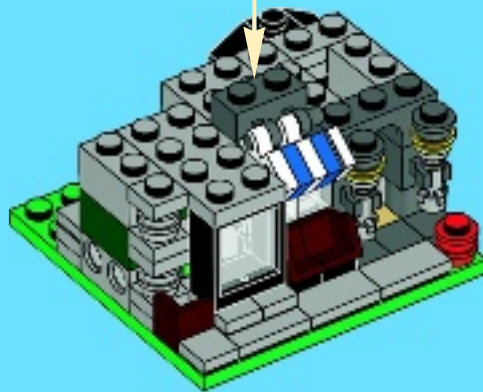

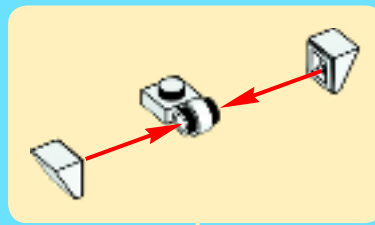
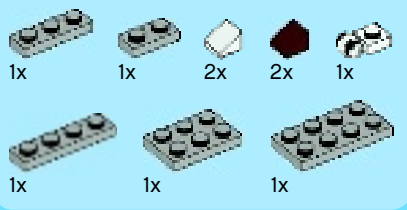

# 13

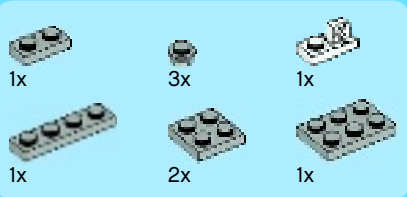
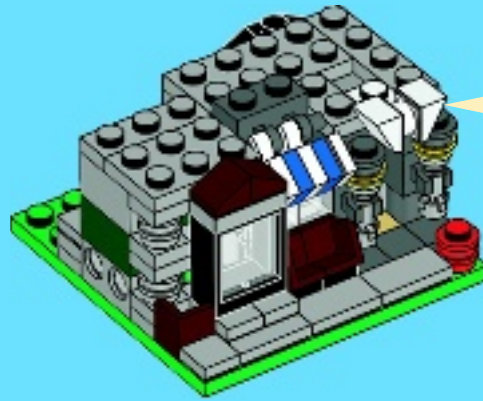

# 14

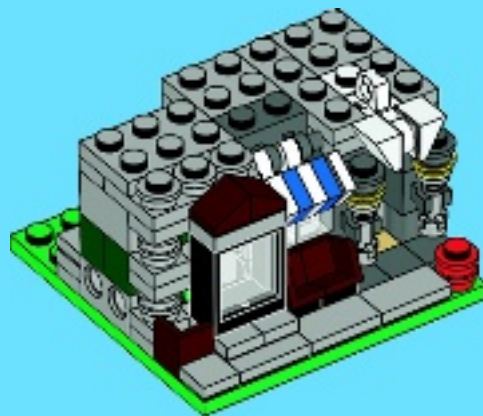



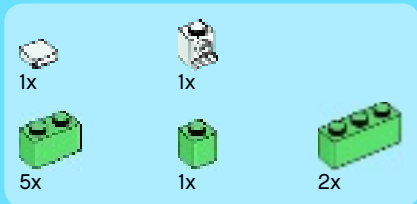

# 15

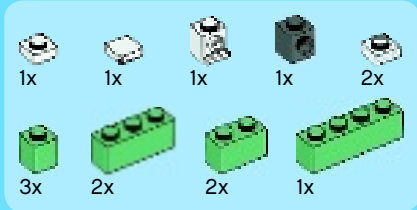
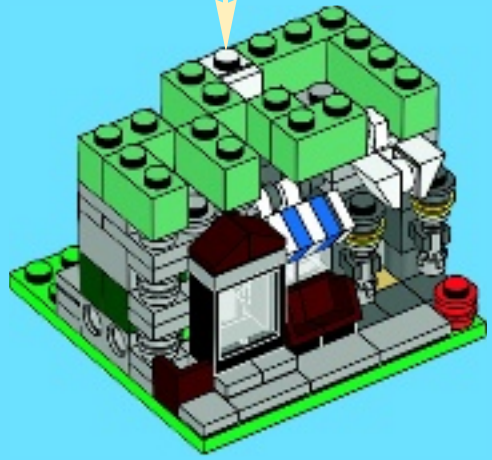
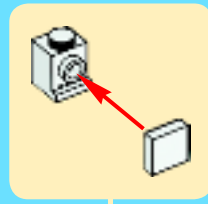

# 16

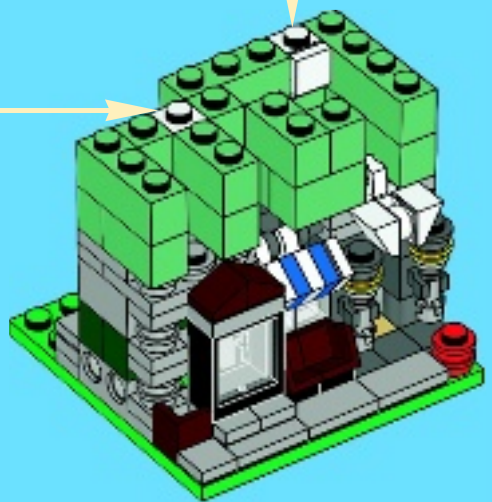
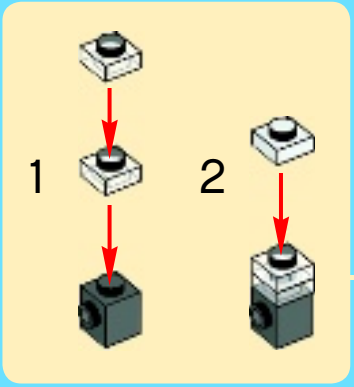
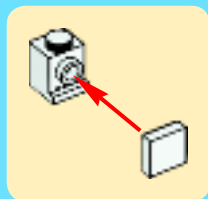

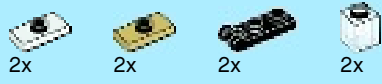

17

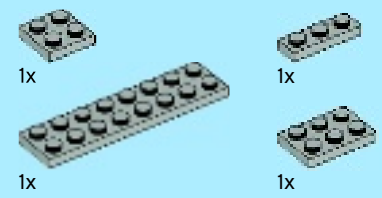
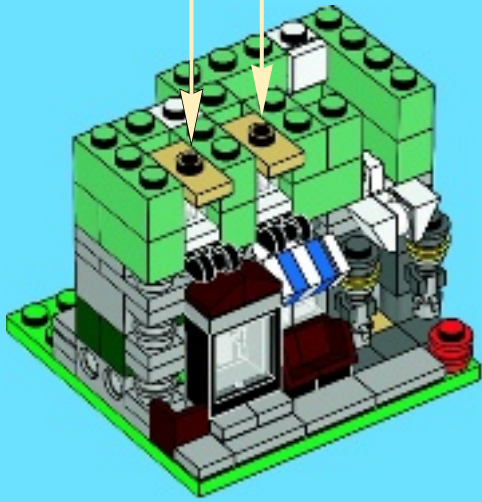
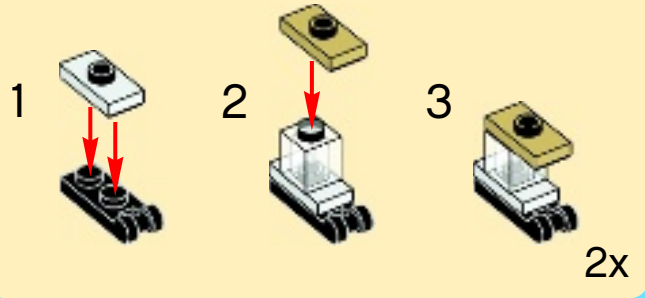

18





2x



2x



3x

# 19

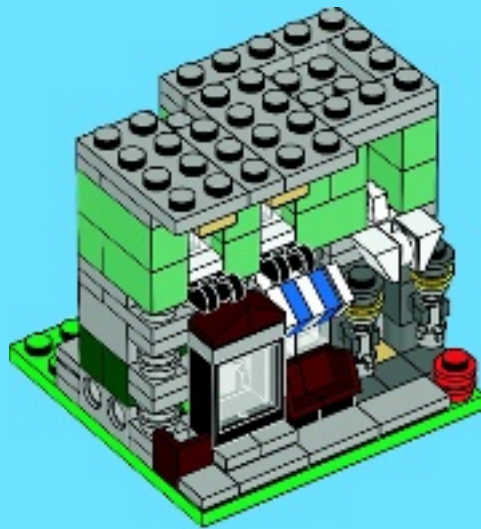

1x



2x



3x



1x



1x

# 20

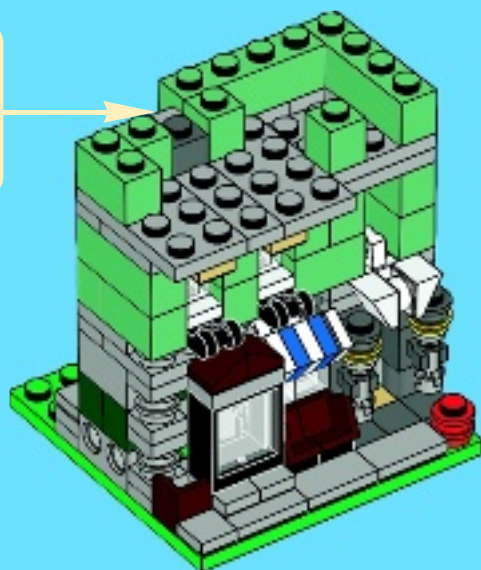
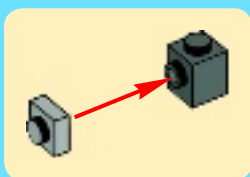

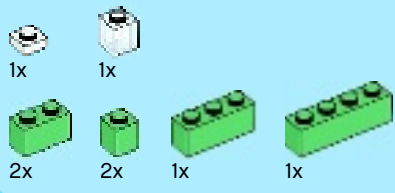

21

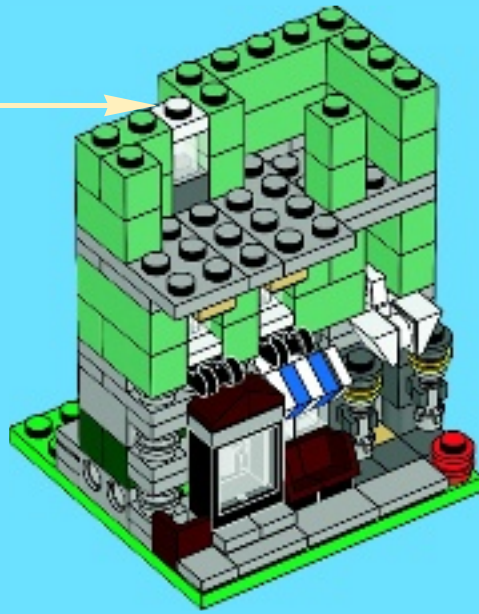
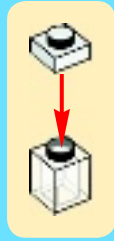

22

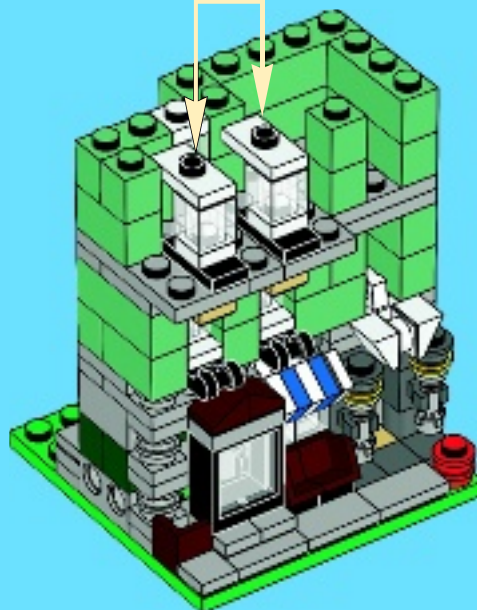
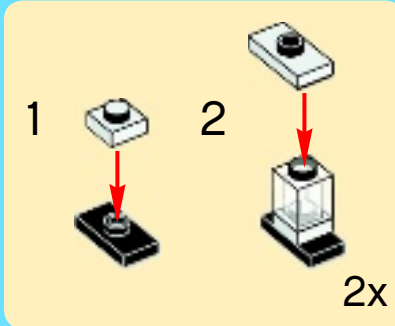



2x



2x



4x

# 23

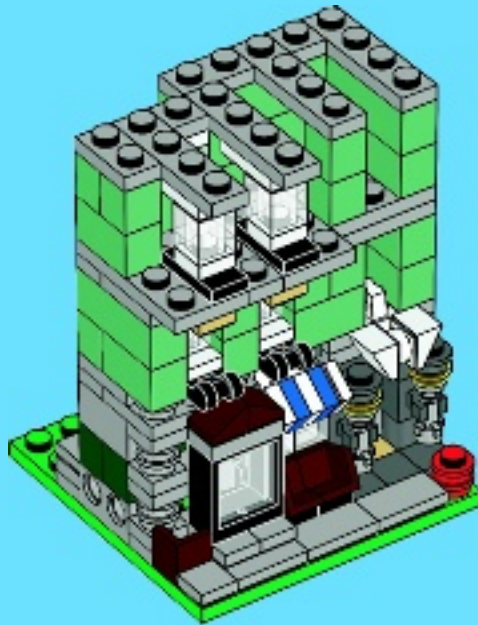

2x



3x



1x



1x

# 24





3x



1x

# 25



1

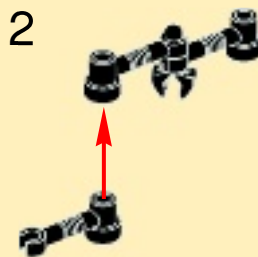

2



3

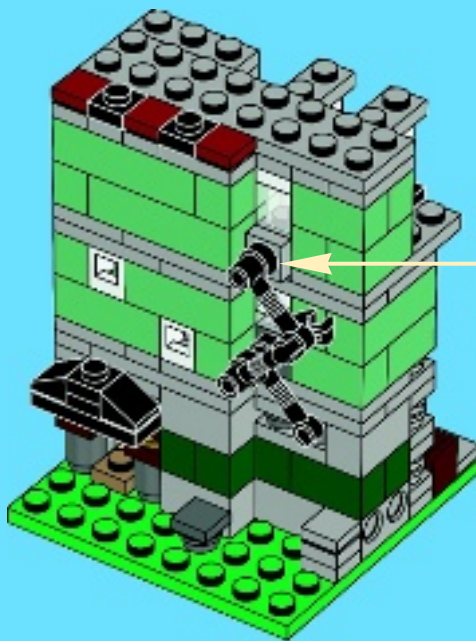

1x



1x



1x



1x

# 26



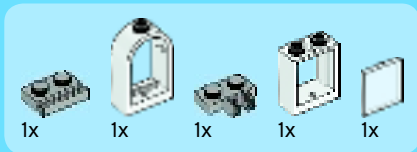

27

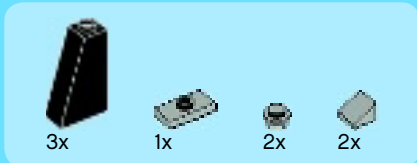
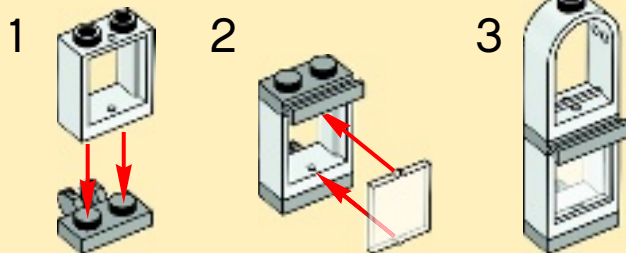

28





2x



1x



2x

# 29



2x



1x



2x

# 30







2x



2x



1x



3x

# 31

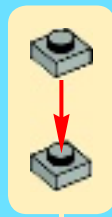

5x



1x

# 32





2x



1x



1x

# 33

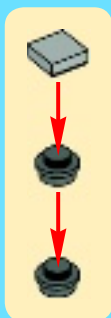



10224

10218

10211





FREE! GRATIS! GRATUIT!



www.LEGOclub.com



LEGO Club Magazine

LEGO and the LEGO logo are trademarks of the/son des marques de commerce de/son marcas registradas de LEGO Group. ©2012 The LEGO Group. 6020961



www.LEGO.com



LEGO Club Email

VISIT THE WORLD'S BIGGEST LEGO SHOP! www.LEGOshop.com

GO TO www.LEGOclub.com

00800 5346 5555 1-866-534-6258 • 1-877-518-5346



\* Freephone. Mobile charges may apply. \* Numéro sans frais. Des frais peuvent s'appliquer avec les téléphones cellulaires. \* Gebührenfrei. Kosten für Anrufe aus Mobilfunknetzen können abweichen. \* Gratis telefonnummer vanaf vaste lijn. \* Det er et gratis nummer, når du ringer fra fasttelefon. \* Det är gratis, när du ringer från en fast telefon. \* Numéro sans frais. Des frais peuvent s'appliquer avec les téléphones portables.

YES! I want to join the LEGO Club FREE! OUI! Je veux m'abonner au LEGO Club GRATUITEMENT! Ja! Ich möchte Mitglied im kostenlosen LEGO Club werden. Ja! Ik wil graag GRATIS lid worden van de LEGO Club. Ja! Jeg ønsker å melde meg inn i LEGO Club gratis! Ja! Jag vill gå med i LEGO Club GRATIS!

Registration form fields: First name, Last name, Date of Birth, Street, City, Zip/Postcode, Email

Mail to / Poster à, Mail to, Per Post an, Stuur op naar, Send til, Skickas till, Poster à

Fill in your email address and we will send you a membership confirmation and monthly email newsletters. If you do not wish to receive the newsletters please tick here. Remplis ton adresse e-mail et nous t'enversons une confirmation d'adhésion ainsi que le bulletin e-mail mensuel. Si tu ne désires pas recevoir le bulletin, coche cette case. Vui je e-mailadres in en we sturen je een bevestiging van je lidmaatschap en maandelijkse e-mail nieuwsbrieven. Als je geen e-mail wilt ontvangen, kruis dan dit vakje aan.

If you do not wish to receive additional mailings from the LEGO Club please tick here. Si tu ne désires pas recevoir de courrier supplémentaire du Club LEGO, coche cette case. Als je geen verdere post van de LEGO Club wilt ontvangen, kruis dan dit vakje aan. Om du vill få annan information från LEGO Gruppen, sätt ett kryss här. Dersom du ønsker å motta annen informasjon fra LEGO Gruppen, setter du et kryss her.

The English language version of the magazine can only be mailed to addresses in the US, Canada, the UK, and Republic of Ireland. Club membership is valid for two years and includes free copies of the LEGO Club Magazine and e-mail newsletters. In the US and Canada please allow up to 6 weeks for delivery of your first magazine. In the UK and Republic of Ireland please allow six to 14 weeks for delivery of your first magazine. By signing this form you consent the LEGO Club to use your child's data for LEGO mailings. The data will only be used for LEGO mailings and will not be sold, rented or otherwise disclosed to any company outside the LEGO Company except for disclosure to companies acting as our agents to help us provide services requested by the child. This coupon is valid for one free membership per person, group or organization. Photocopied coupons are accepted. La version française du magazine peut être postée uniquement au Canada. L'abonnement est valide pour 2 ans et inclut des exemplaires gratuits du Magazine LEGO. Aux E-U. et au Canada, allouer 6 semaines pour la livraison initiale. En remplissant ce formulaire, vous consentez à ce que LEGO utilise les informations de votre enfant pour des envois postaux de LEGO. L'information sera utilisée uniquement pour des envois postaux par LEGO et ne sera en aucun cas, vendue, louée, échangée ou divulguée à d'autres compagnies autres que la compagnie LEGO, à l'exception des compagnies affiliées qui nous procurent des services auxquels l'enfant en a fait la demande. Formulaires photocopiés acceptés. Mit der folgenden Unterschrift erkläre ich, für mein Kind den Beitritt als Mitglied zum kostenlosen LEGO Club, der von der LEGO GmbH, D-85627 Grasbrunn, betrieben wird. Die Mitgliedschaft beinhaltet die Zusendung des LEGO Club Magazines und kann beiderseits jederzeit beendet werden. Mir der Mitgliedschaft im LEGO Club sind keinerlei Verpflichtungen verbunden. Das deutschsprachige LEGO Club Magazin wird nur an Adressen in Deutschland, Österreich und der Schweiz versendet. Eine Anmeldebestätigung kann nur per E-Mail geschickt werden. Das Magazin erscheint fünfmal jährlich. Daher kann die Zustellung des ersten Heftes bis zu drei Monate dauern. Die Mitgliedschaft ist beidseitig jederzeit kündbar, ohne dass Ihnen Kosten entstehen. Sie können der werblichen Nutzung Ihrer Daten jederzeit widersprechen, Kündigung und Widerspruch können Sie telefonisch erklären (00800 / 5346 5555, Anruf gebührenfrei. Kosten für Anrufe aus dem Mobilfunknetz können abweichen) oder an die LEGO GmbH senden. Het Nederlandse LEGO Club Magazine kan alleen worden gestuurd naar adressen in Nederland. Het lidmaatschap is 2 jaar geldig en geeft recht op toezending van het gratis LEGO Club Magazine en LEGO Club e-mails. Het eerste magazine zal binnen 12 tot 14 weken toegestuurd worden. Het lidmaatschap kan op ieder moment opgezegd worden en kan na 2 jaar gratis worden verlengd, tenzij LEGO met deze activiteit stopt. Uw gegevens worden uitsluitend gebruikt voor mailings van LEGO en zullen niet worden verkocht, verhuurd of op welke wijze dan ook verstrekt aan derden buiten de LEGO Groep, uitgezonderd de organisaties die namens ons optreden om de informatie te sturen waarvoor toestemming is verleend. Den norske utgaven av magasinet sendes kun til adresser i Norge. Medlemskap i klubben gjelder 12 år og inkluderer gratisutgaver av LEGO Club Magazine. Påreg minimum opp til seks uker leveringstid for første magasin. Ved å undertegne dette skjemaet, gir du ditt samtykke til at LEGO Club kan bruke opplysningene om barnet ditt i LEGO forsendelser. Dataene vil utelukkende bli brukt i LEGO forsendelser og vil ikke bli solgt, utleid eller på annen måte gøres tilgjengelig for selskaper utenfor LEGO gruppen, unntatt selskaper som er våre agenter og som hjelper oss å tilby tjenestene barnet ettertar. Dette skjemaet gjelder for ett gratis medlemskap per person, gruppe eller organisasjon. Den svenske versionen av tidningen kan endast skickas till adresser i Sverige. Club-medlemskapet är giltigt i 2 år och innefattar gratis exemplar av LEGO Club Magazine. Vårigen räkna med minimum 6 veckor för leverans av din första tidning. Genom att skicka in det här formuläret godkänner du att LEGO Club använder barnets uppgifter för LEGO utskick. Uppgifterna kommer bara att användas för LEGO utskick och kommer inte att säljas, hyras ut eller vidarebefordras till något företag som inte tillhör LEGO Gruppen, med undantag av företag som agerar som våra ombud för att tillhandahålla tjänster som barnet har begärt. Den här kupongen gäller för ett gratis medlemskap per person, grupp eller organisation. En komplett en bulletin d'adhésion, vous acceptez que LEGO Club utilise les données relatives à votre enfant pour l'envoi de courriers concernant LEGO. Ces données seront uniquement utilisées pour l'envoi d'information concernant LEGO et ne seront ni vendues, ni louées, ni utilisées par d'autres sociétés que le groupe LEGO, à l'exception des sociétés agissant pour le compte de LEGO en tant que sous-traitant de services divers. L'abonnement au LEGO Club est valable pour une période de 2 ans. Il inclut l'envoi par courrier du magazine LEGO Club et par email des newsletters. Un délai de 6 à 14 semaines est à prévoir pour la réception de votre premier magazine. Ce bulletin d'adhésion gratuit est valable pour l'inscription d'une seule personne. Les photocopies sont acceptées. ATTENTION! Le bulletin d'adhésion doit être rempli et signé par un parent ou un tuteur.

Parent's signature - Signature d'un parent ou d'un tuteur - Unterschrift Erziehungsberechtigter / Handtekening ouders - Foreldres/foresattes underskrift - Förälders / förmyndares underskrift

Date Datum Date

B116