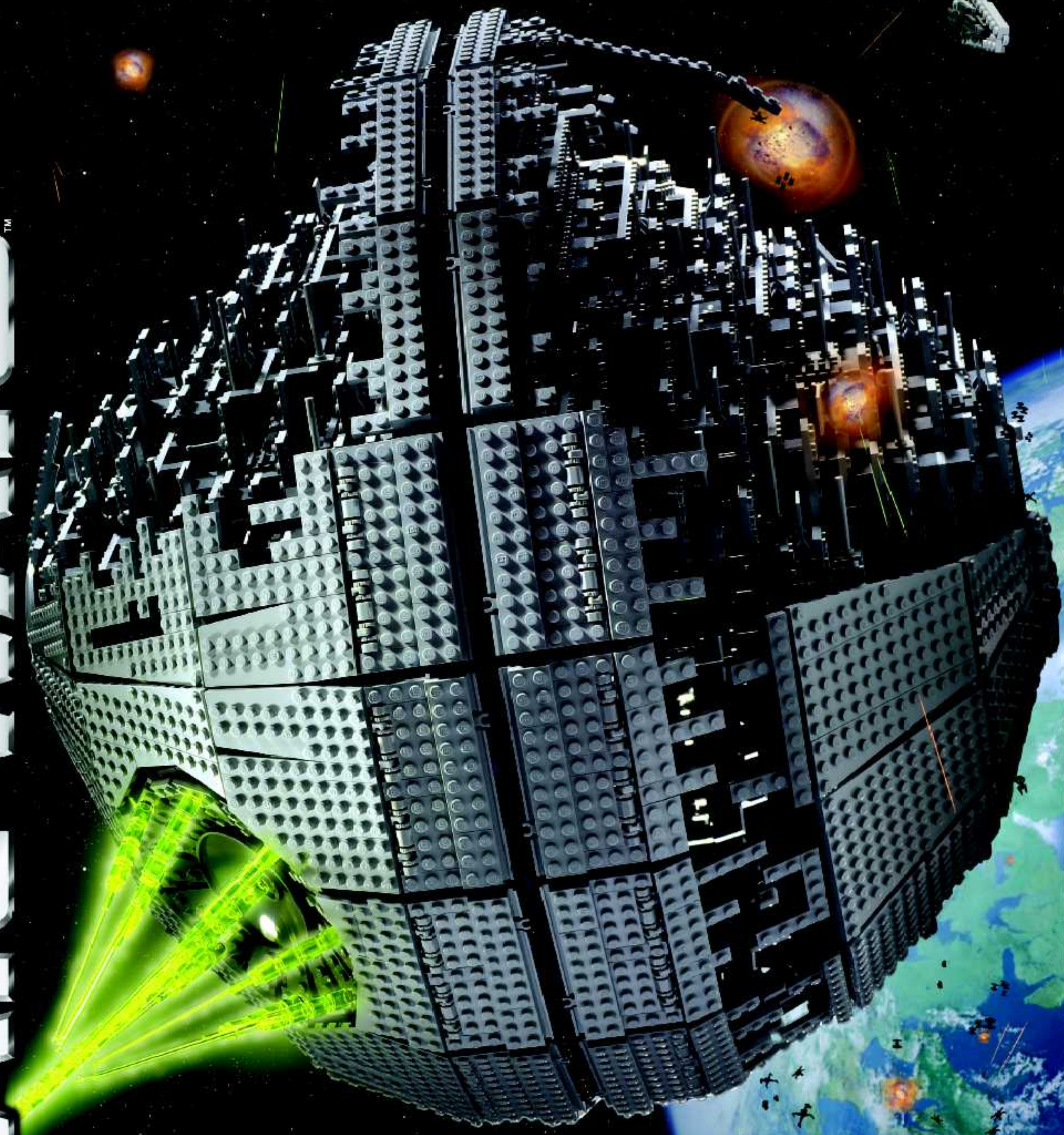

# STAR WARS™

The LEGO logo is displayed in its characteristic white, rounded font with a black outline, set against a solid red rectangular background.

**10143**

UCS Death Star II™

**STAR WARS**  
ORIGINAL TRILOGY EDITION

4289405



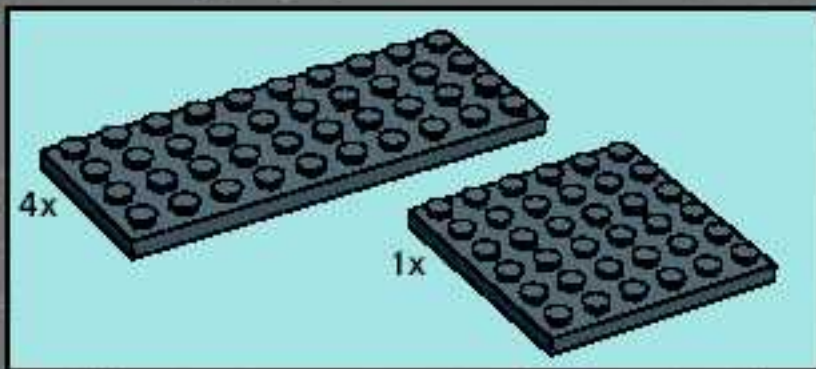
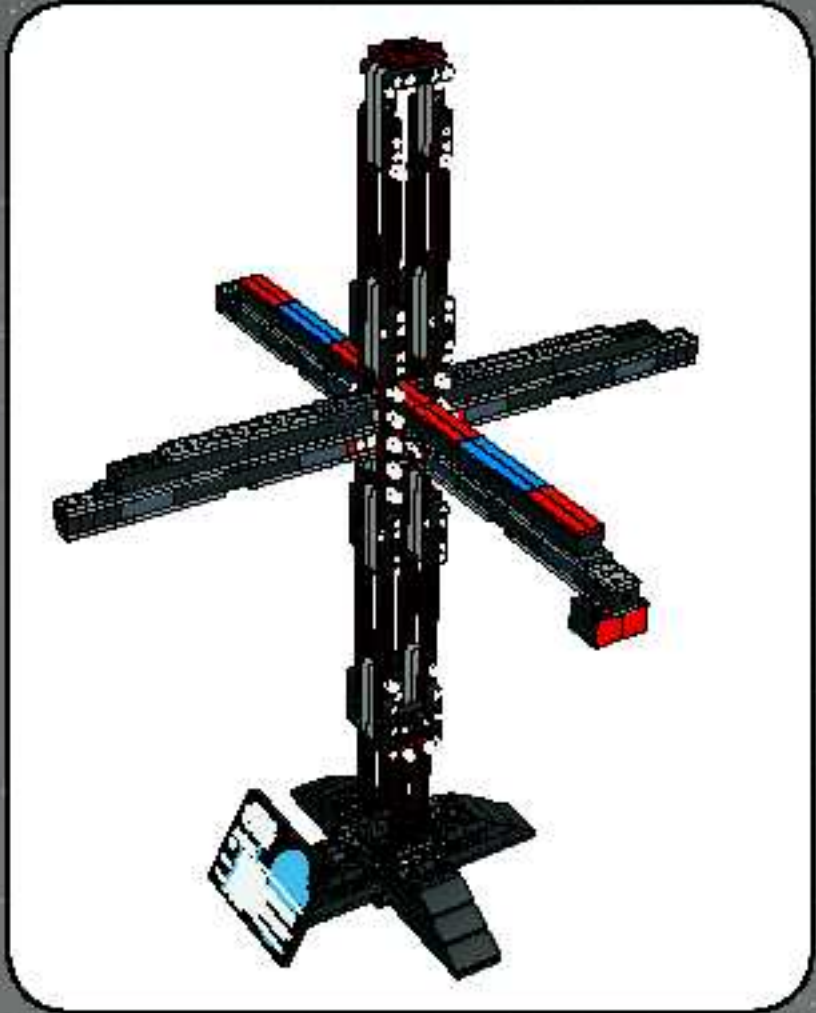
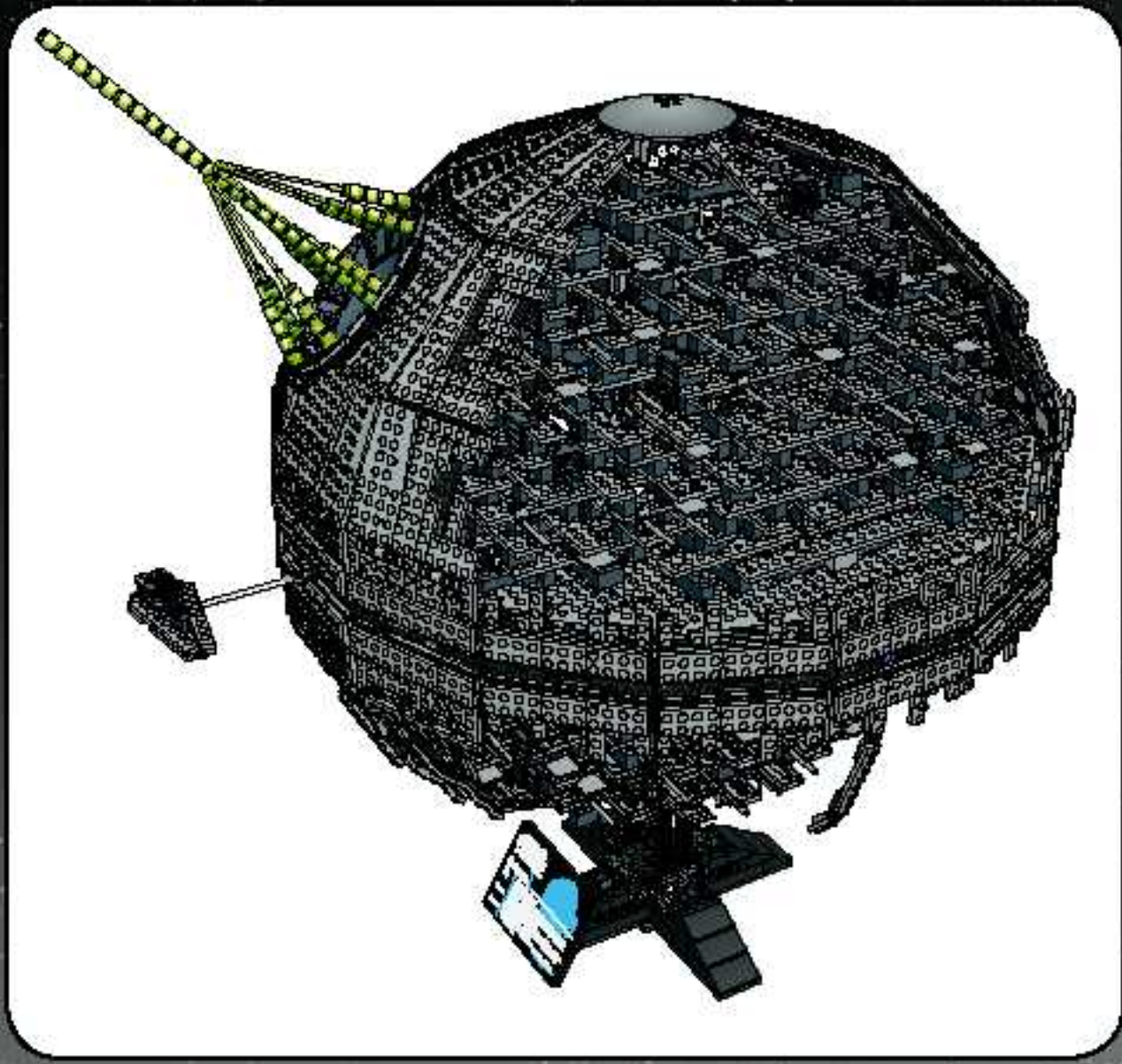

1

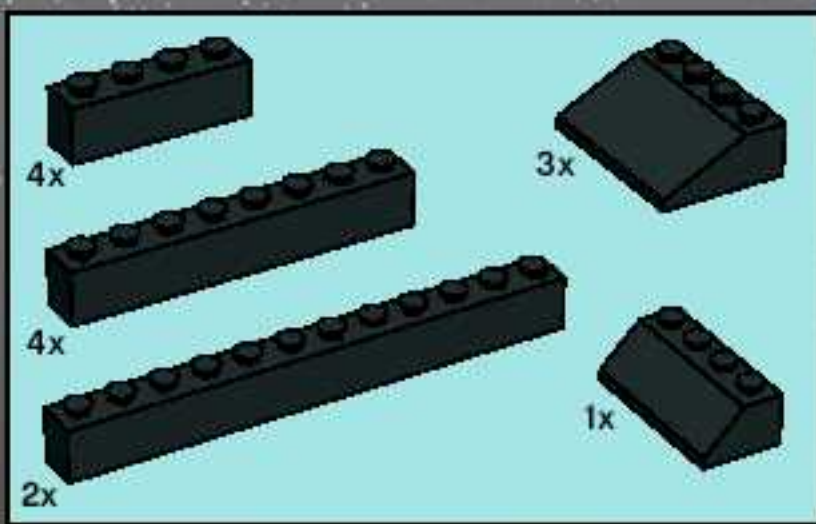
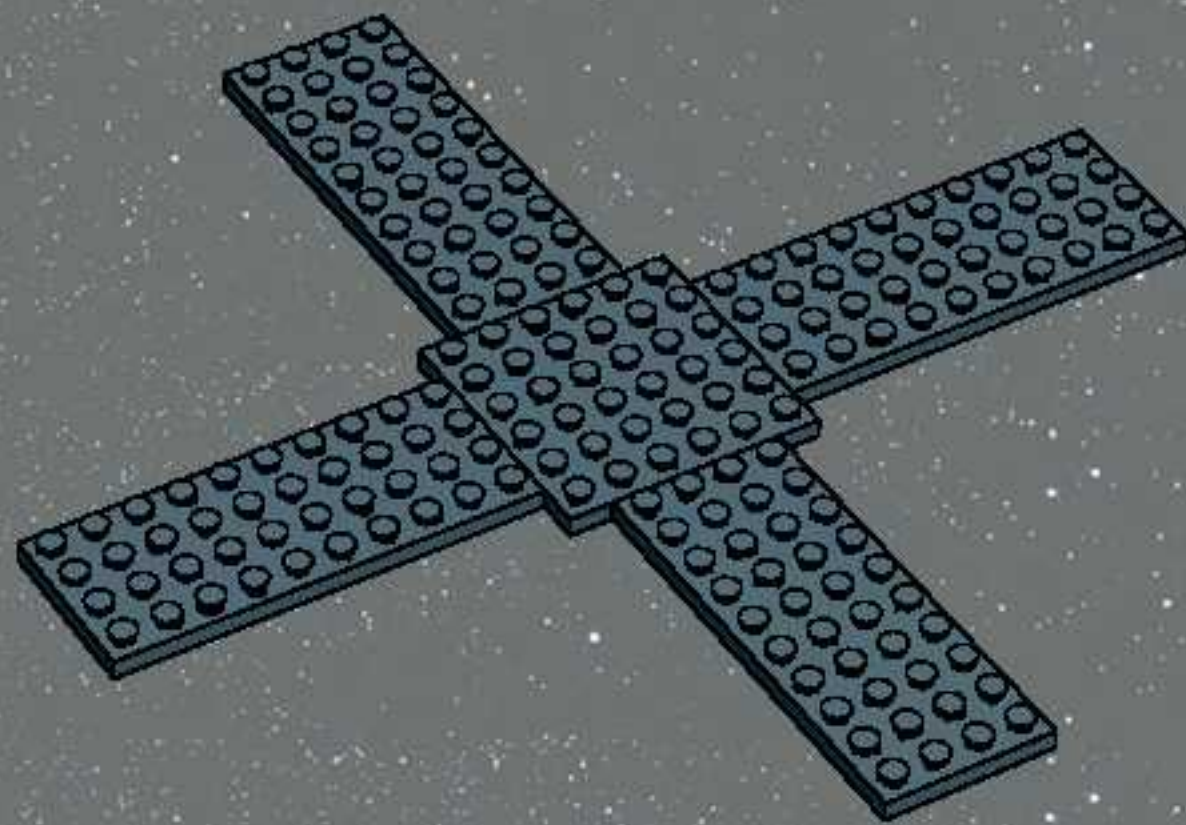

2

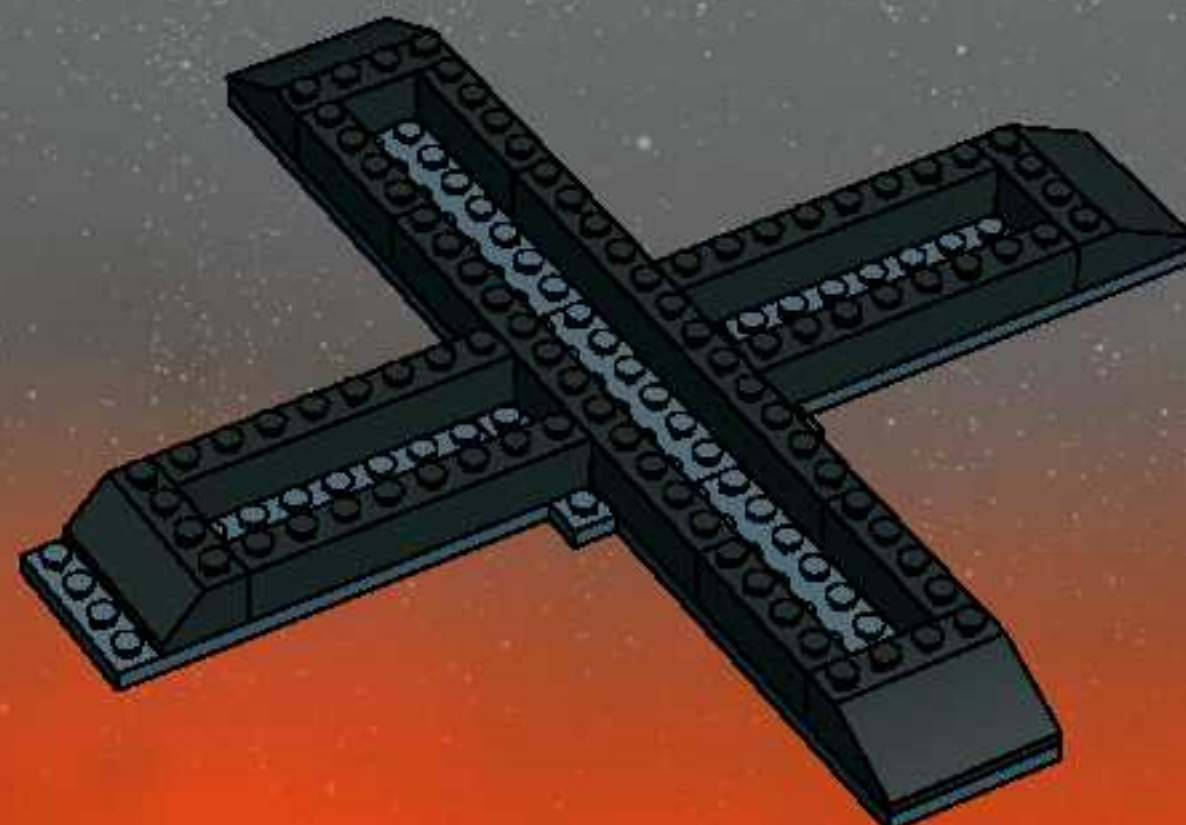



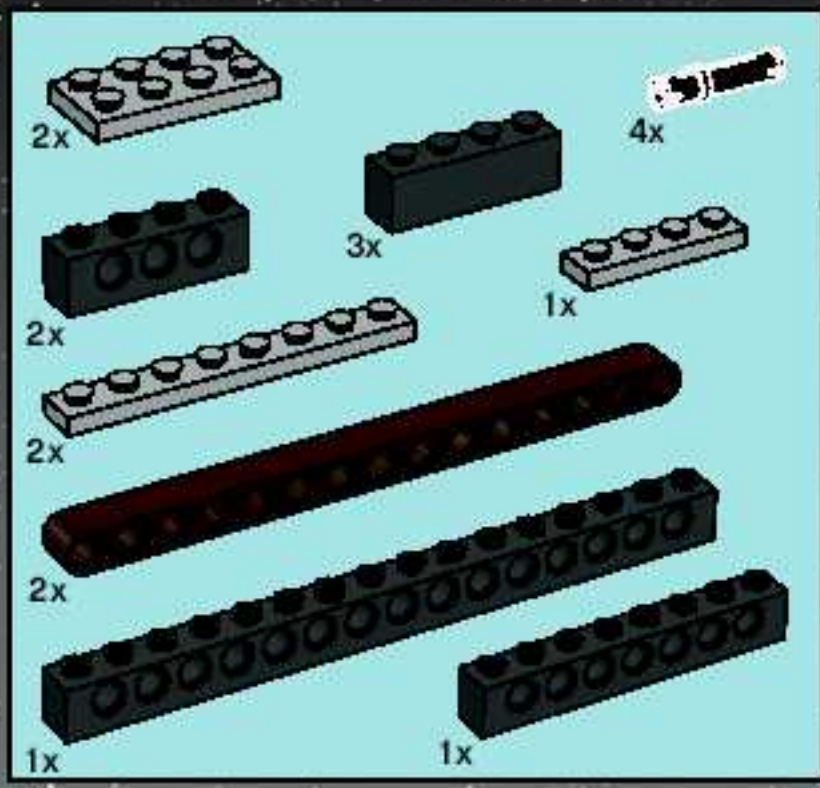

3

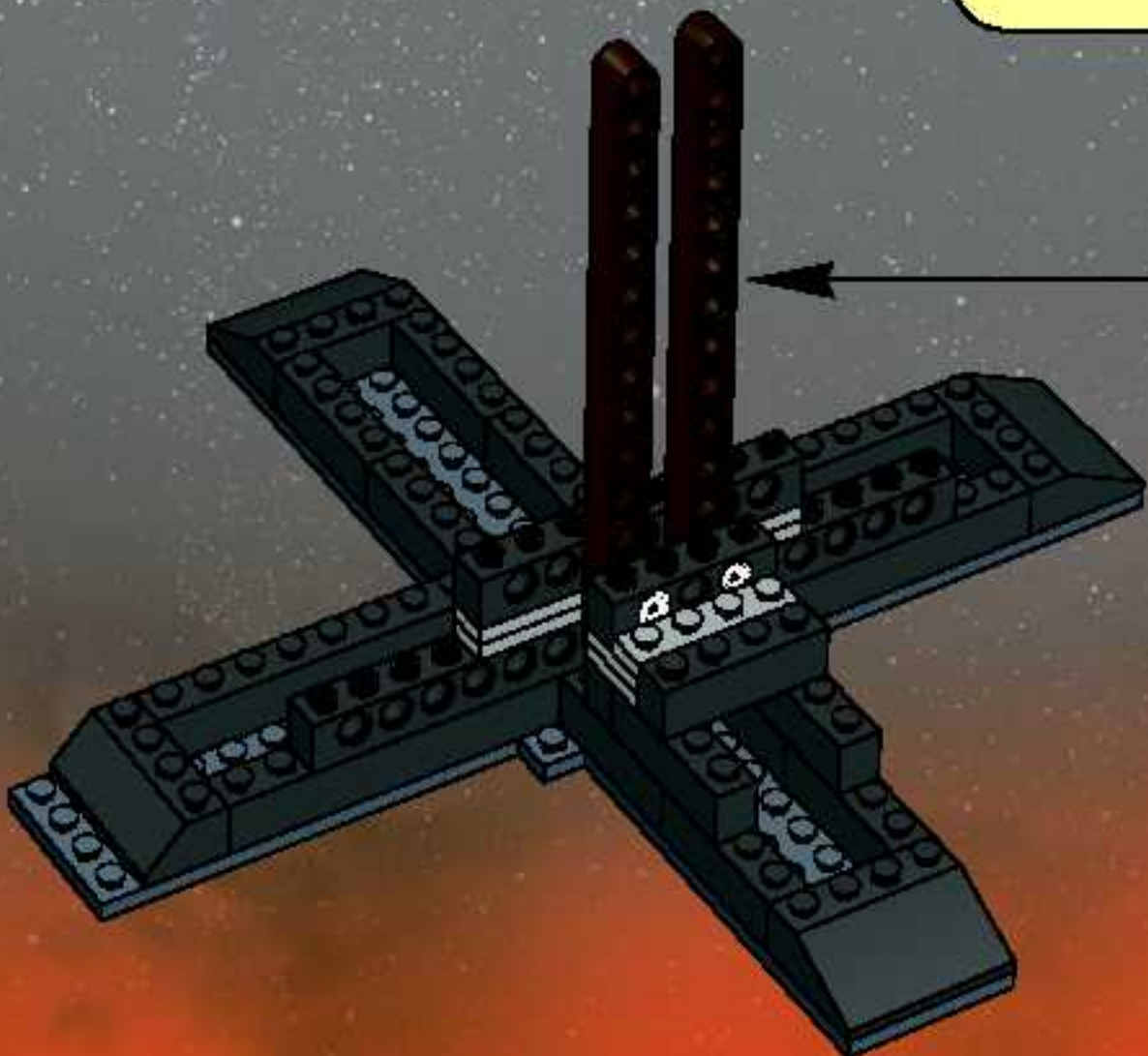
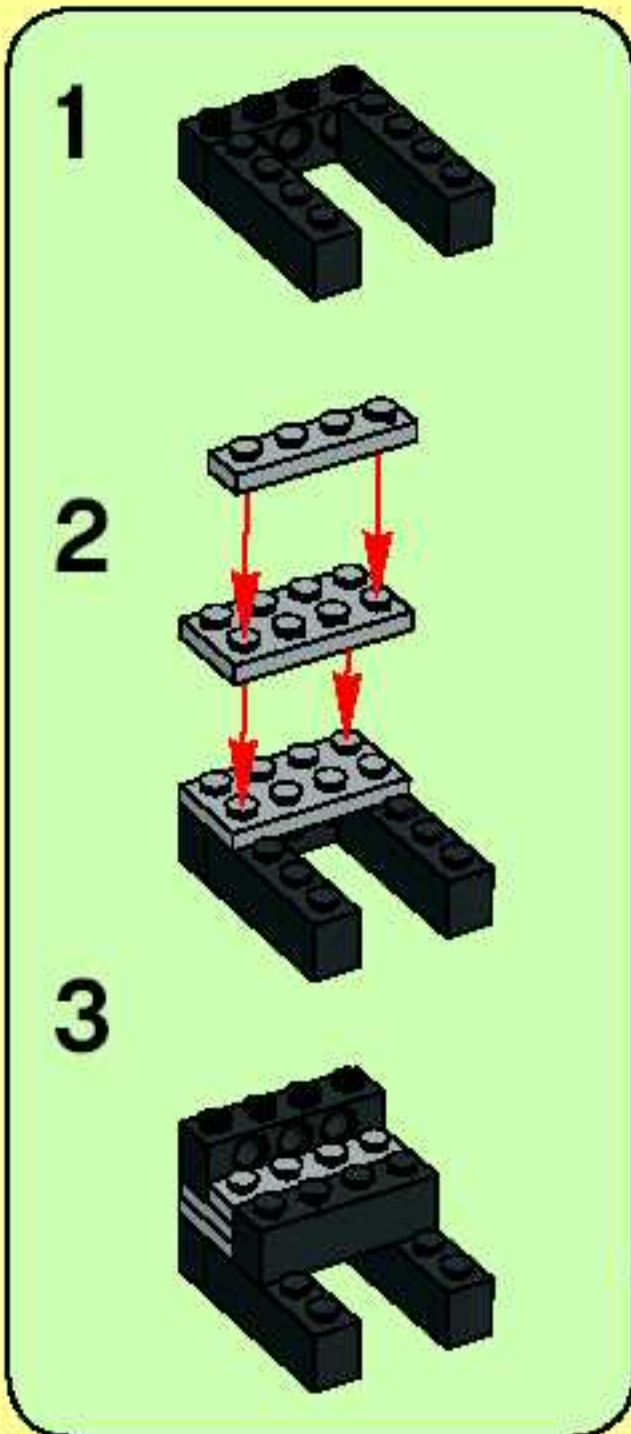
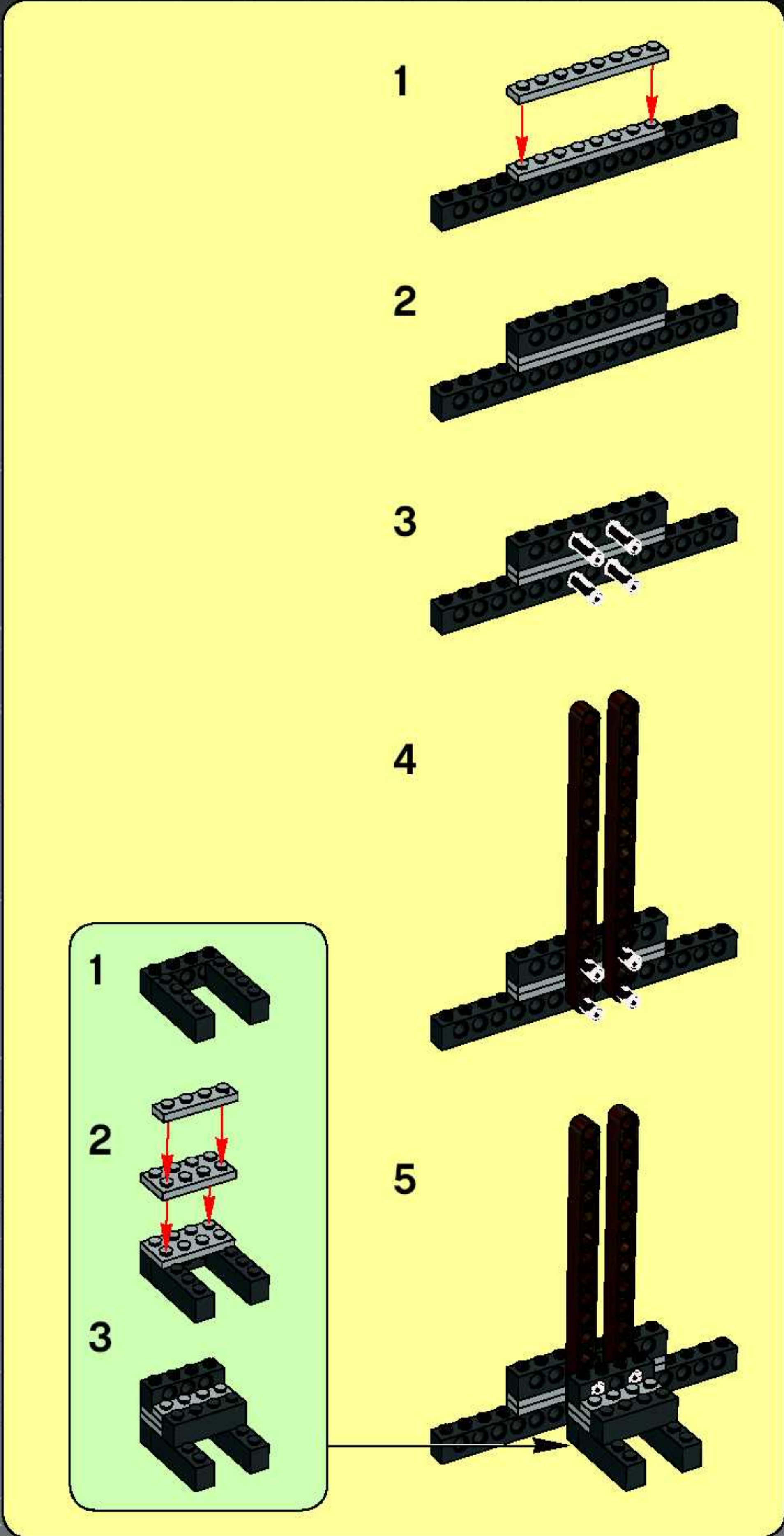



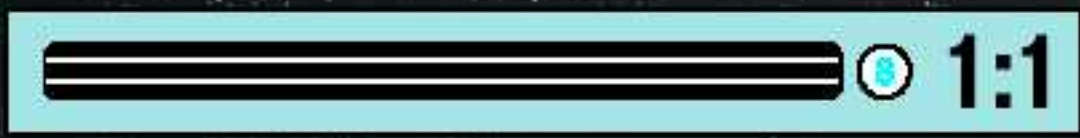
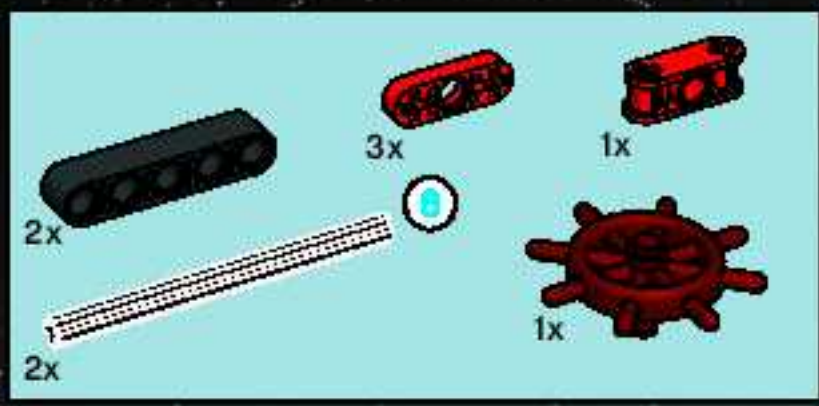

4

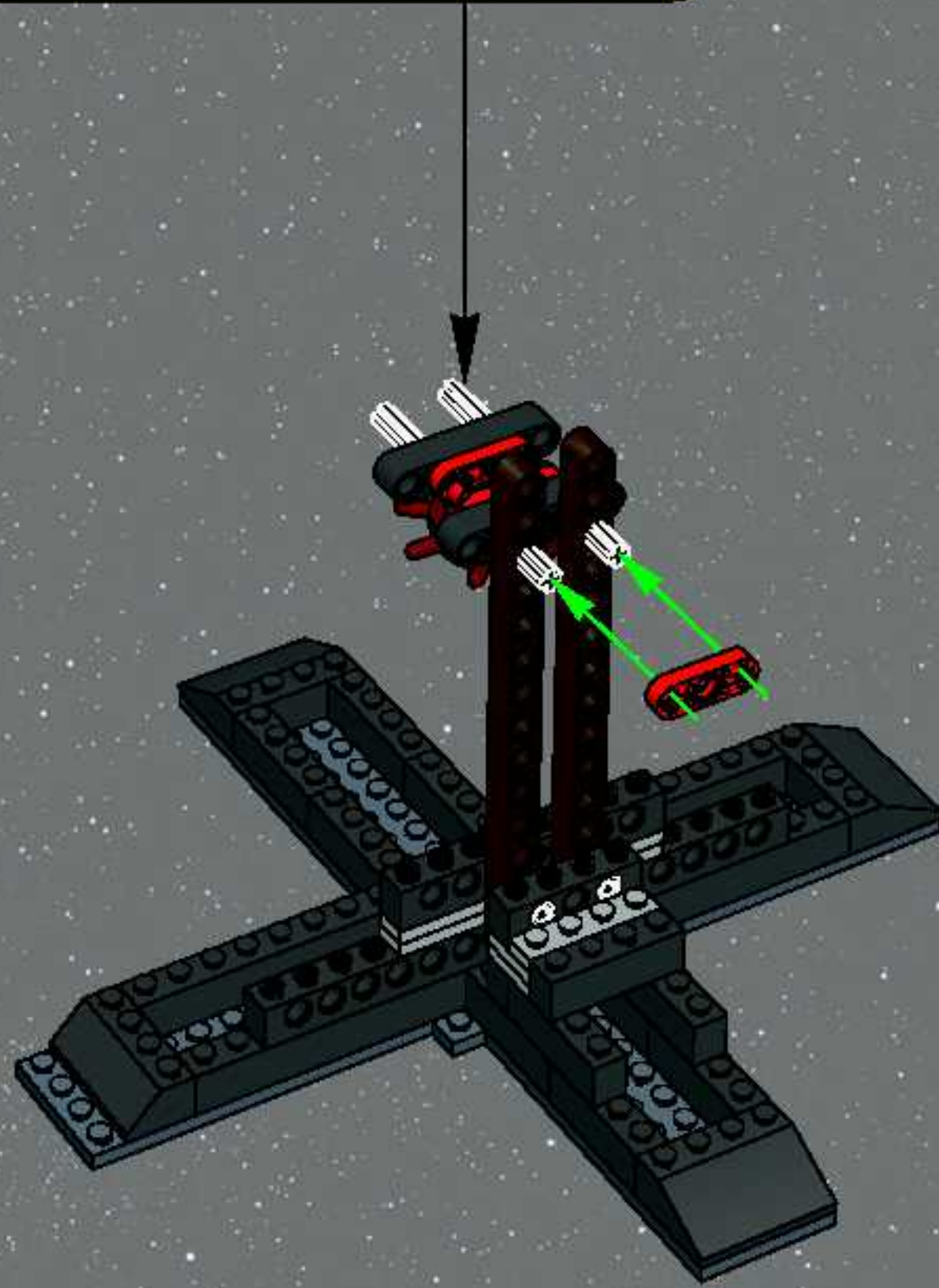
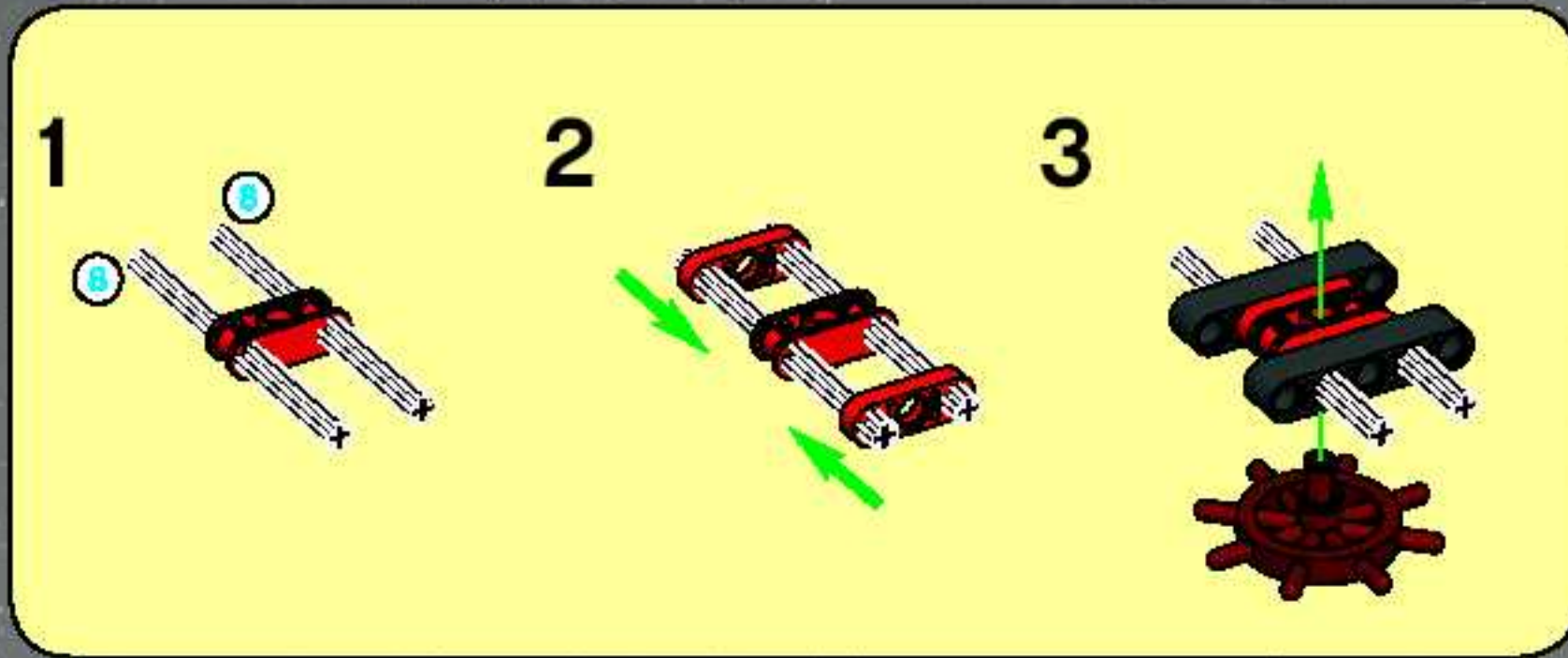



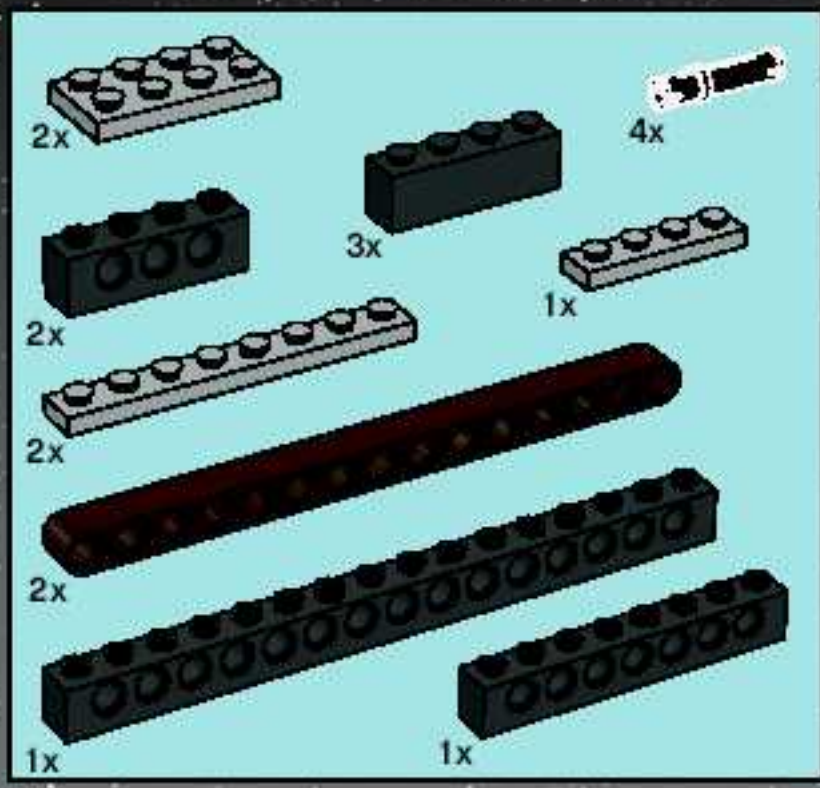

# 5

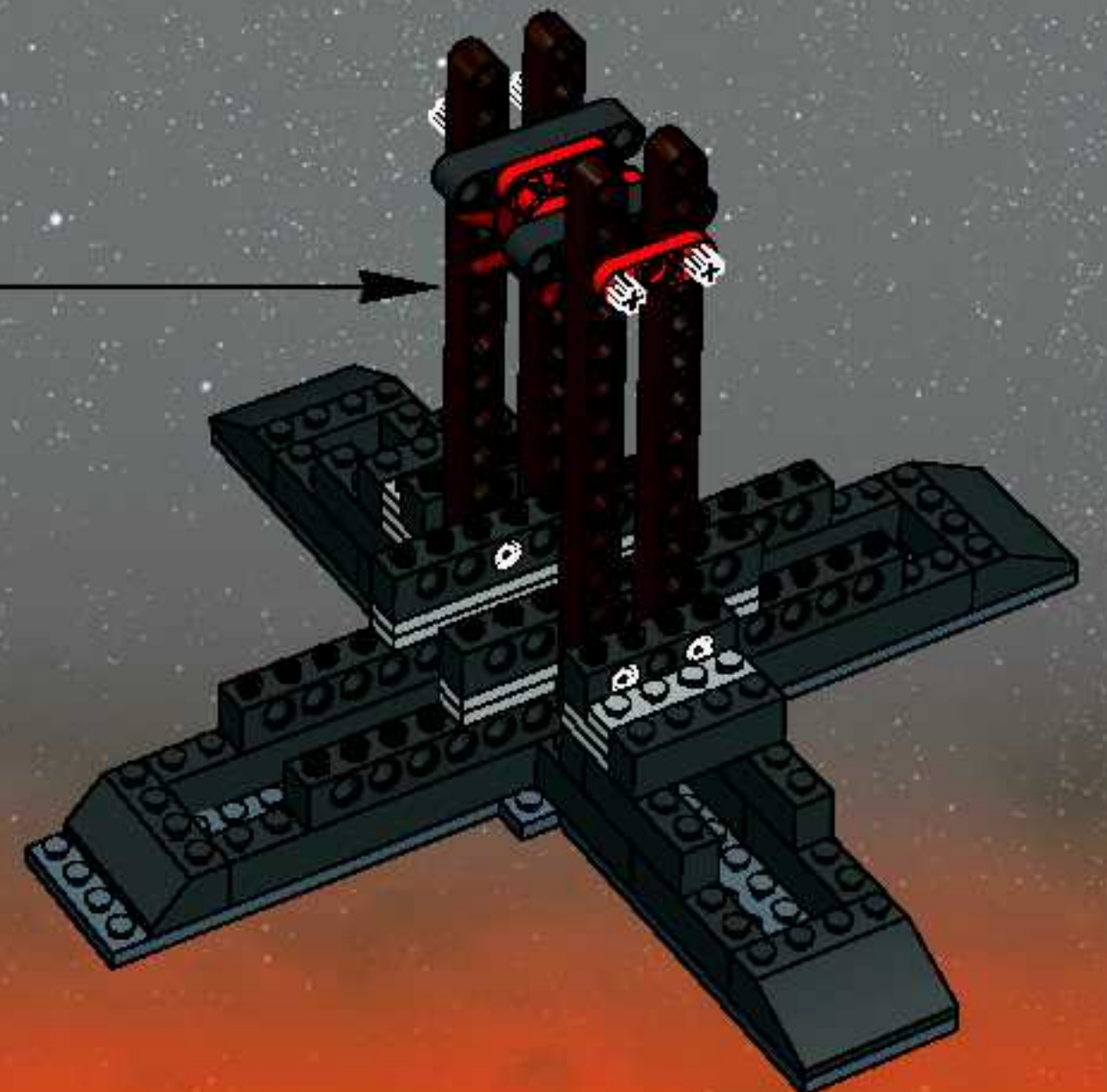
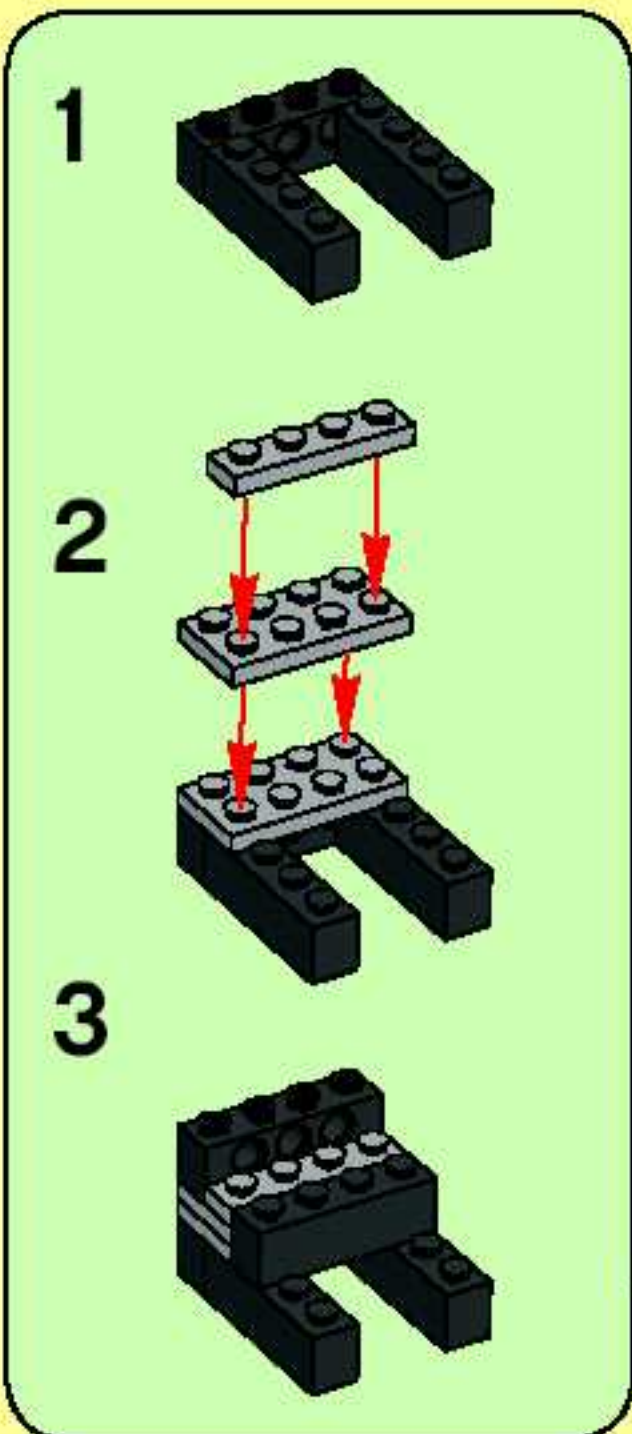
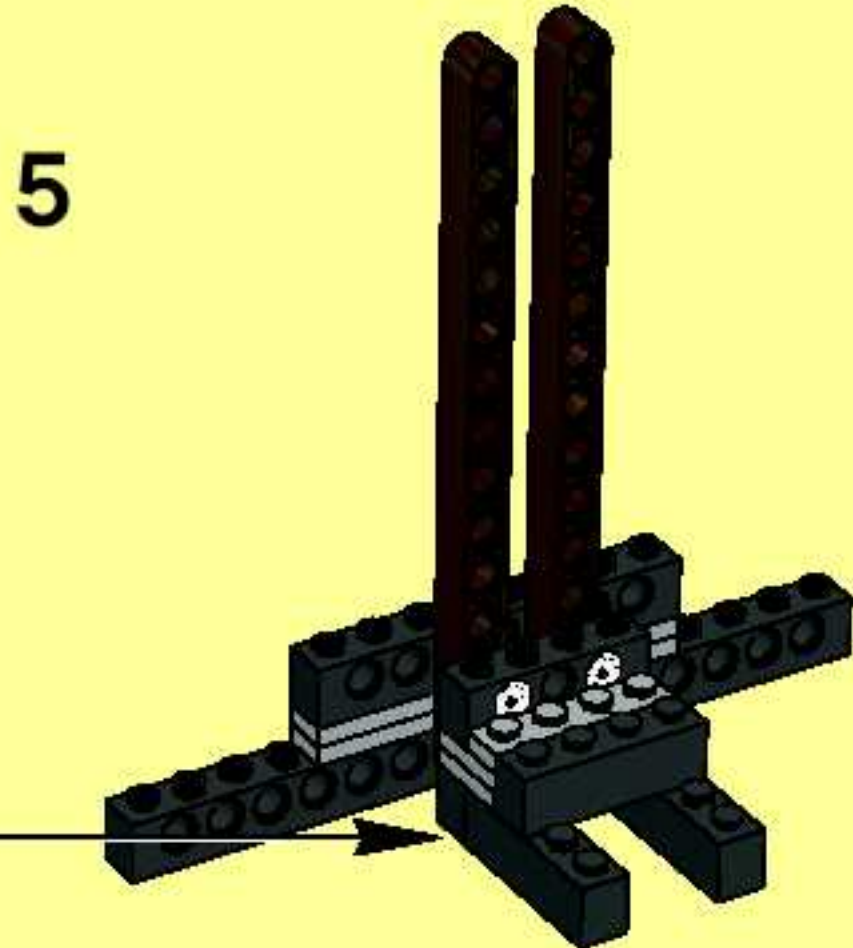
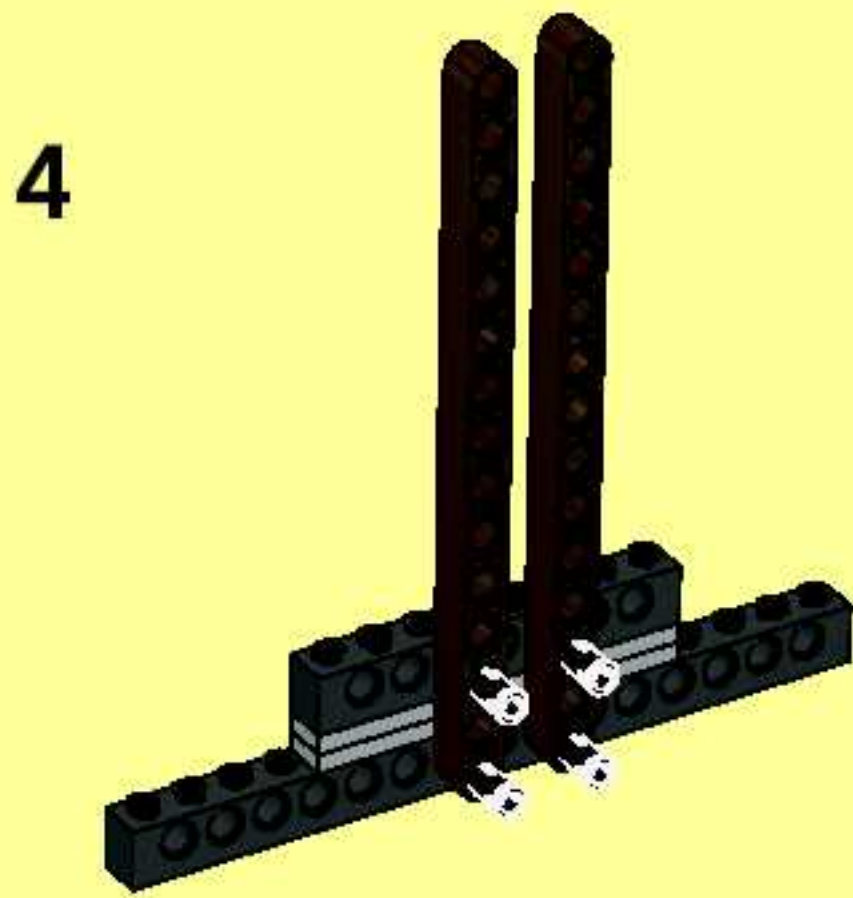
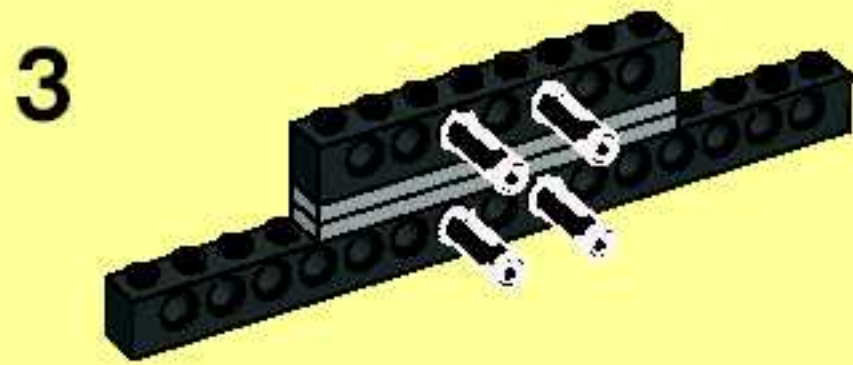
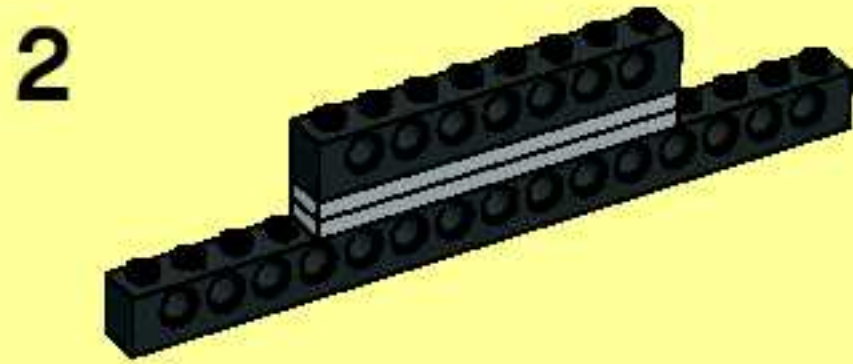
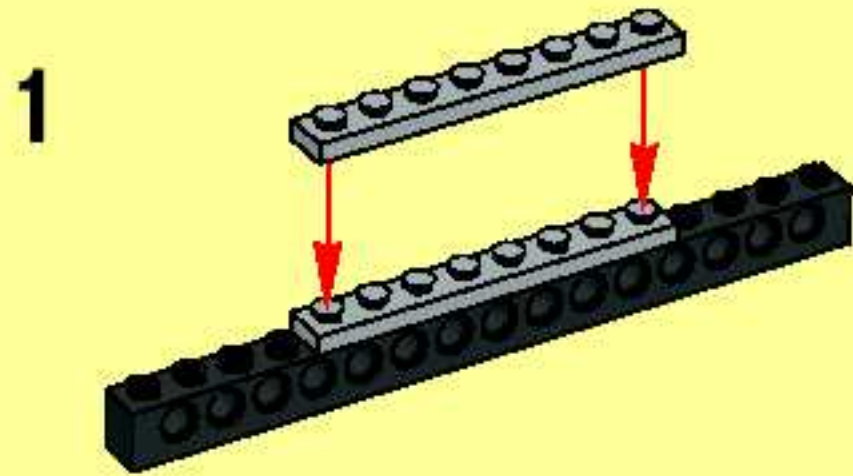



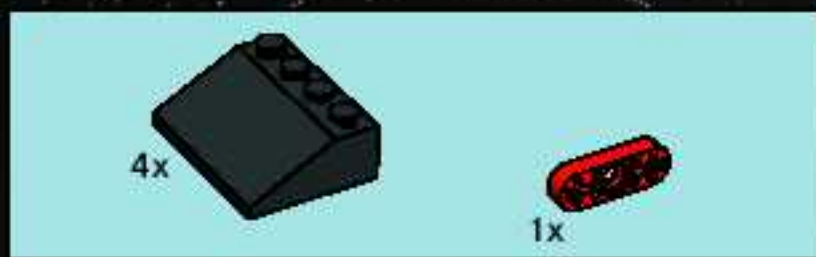

6

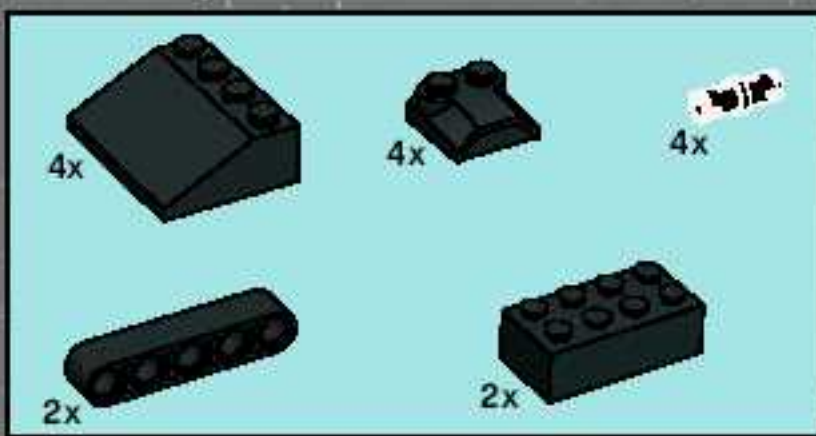

7

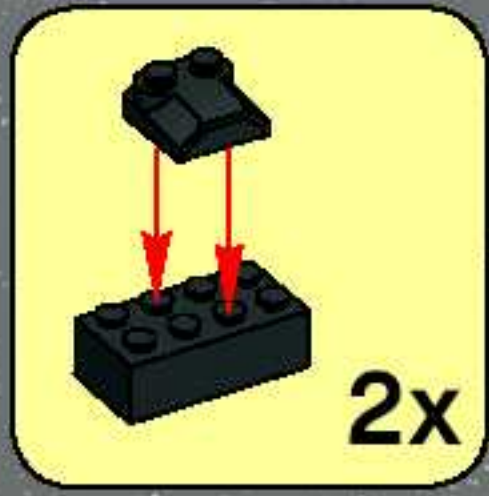





8

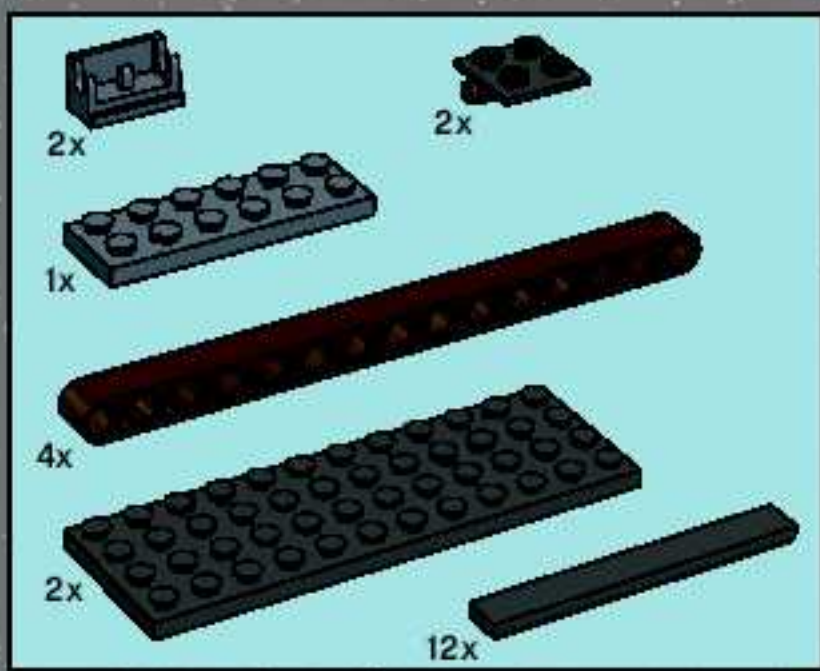
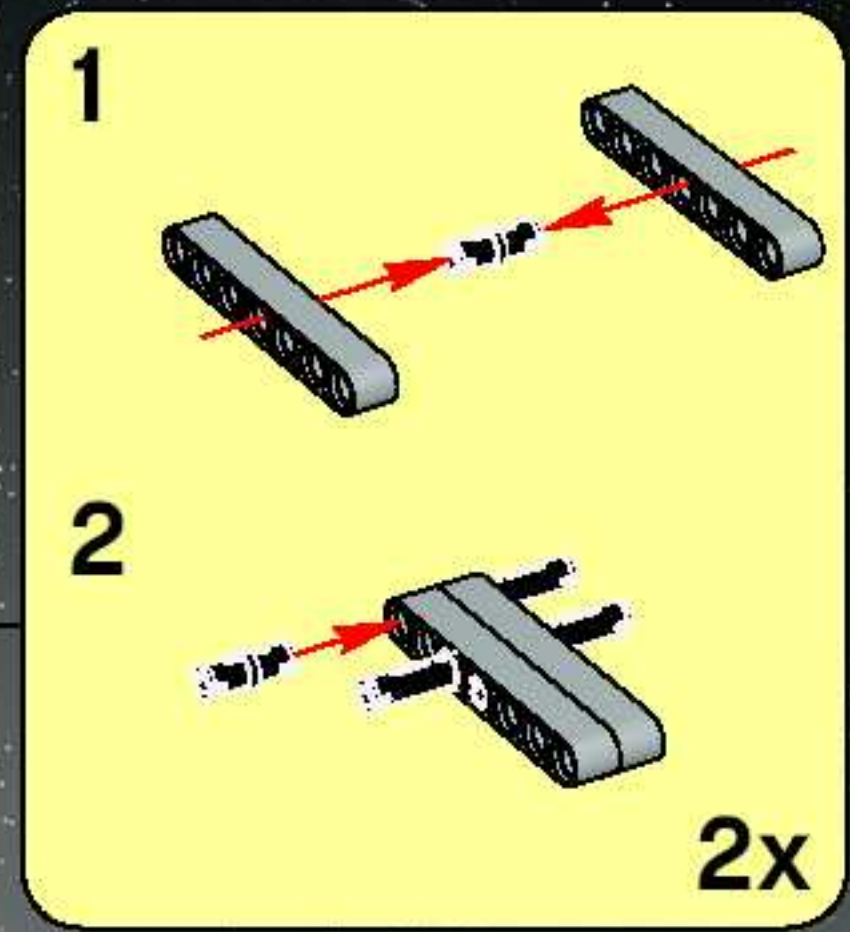
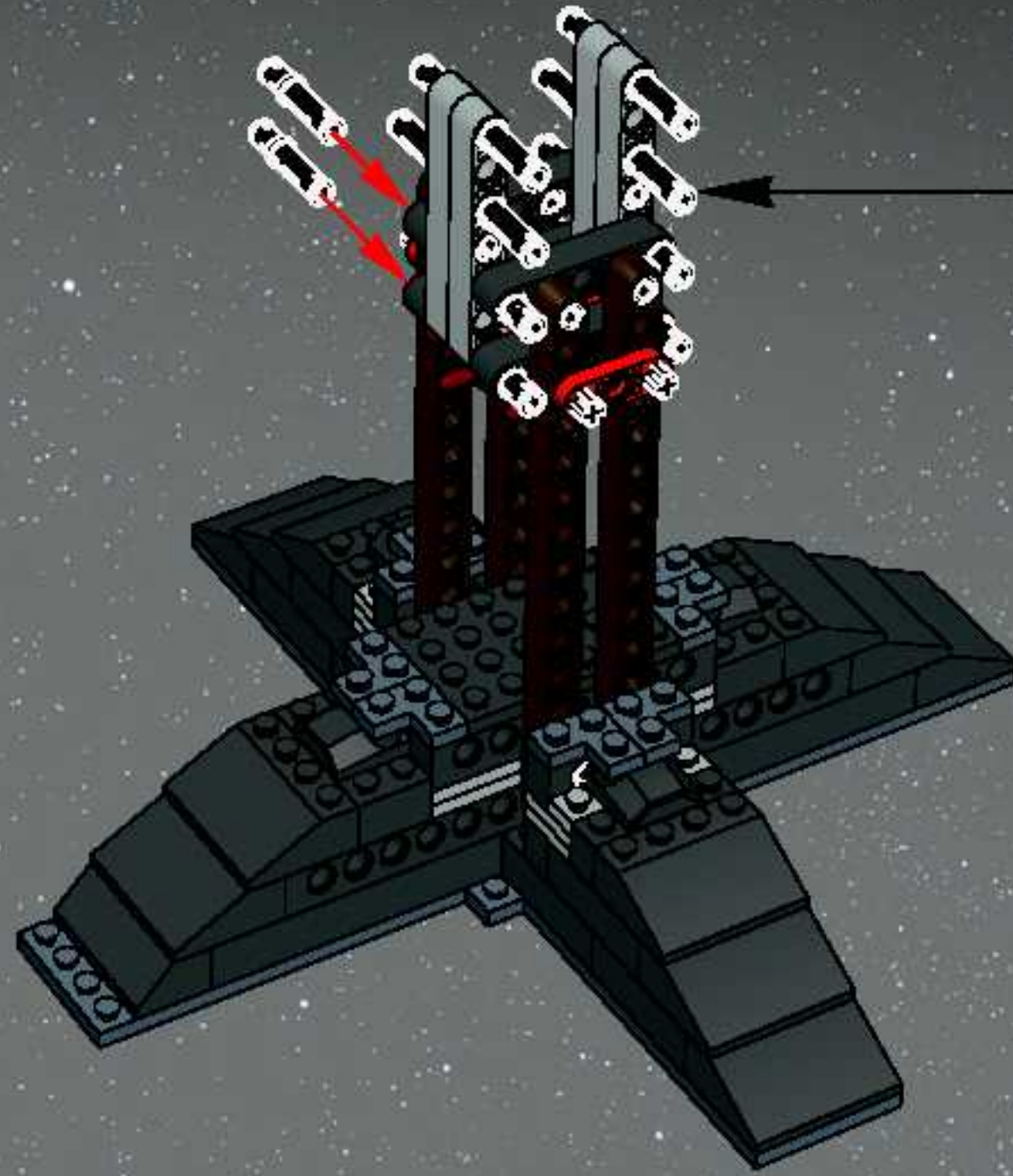

9

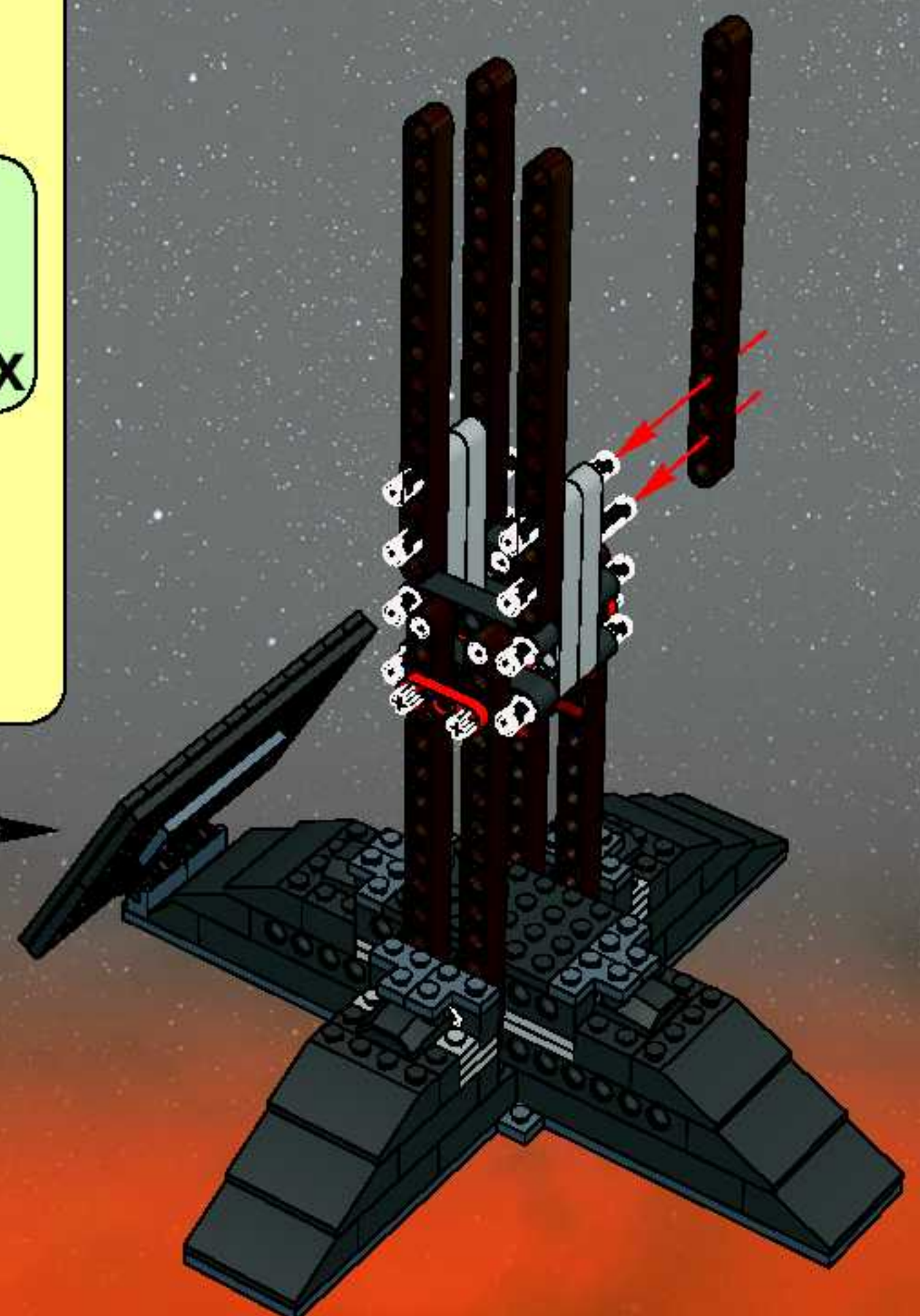
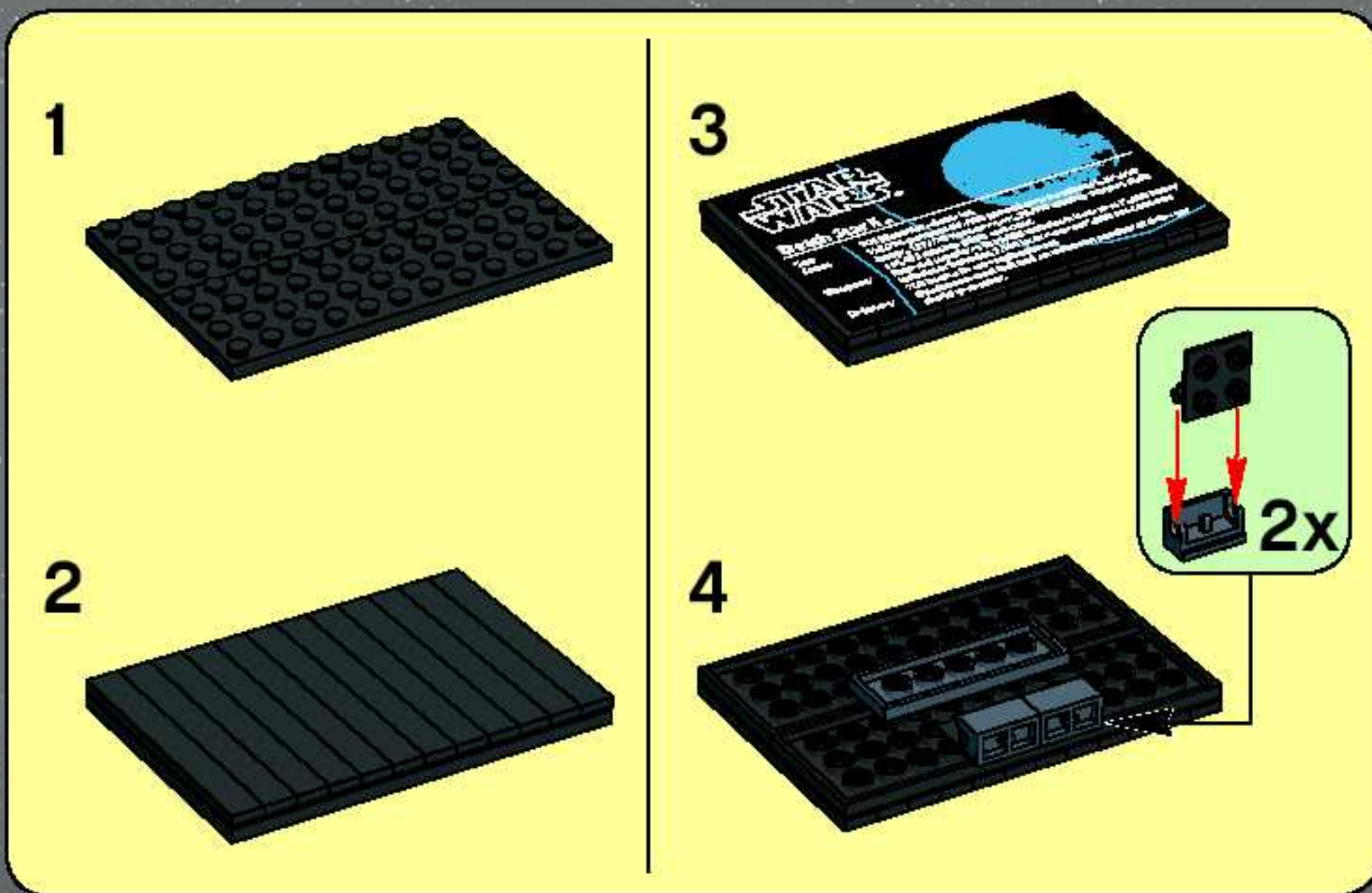



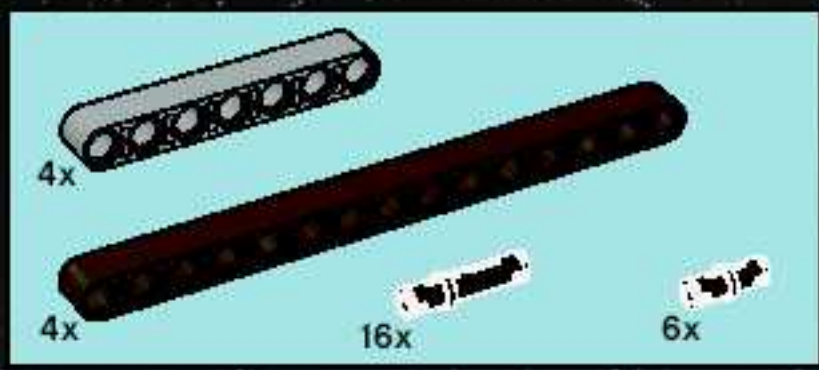

10

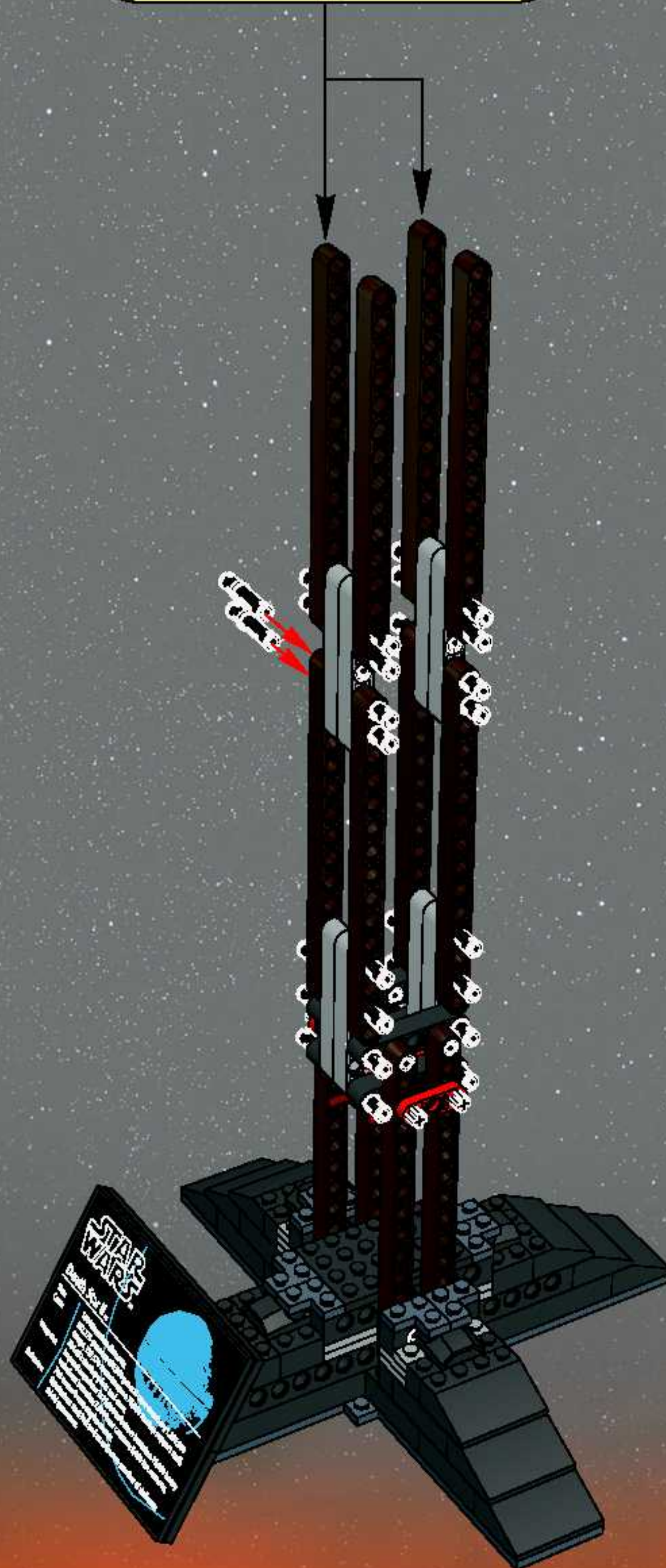
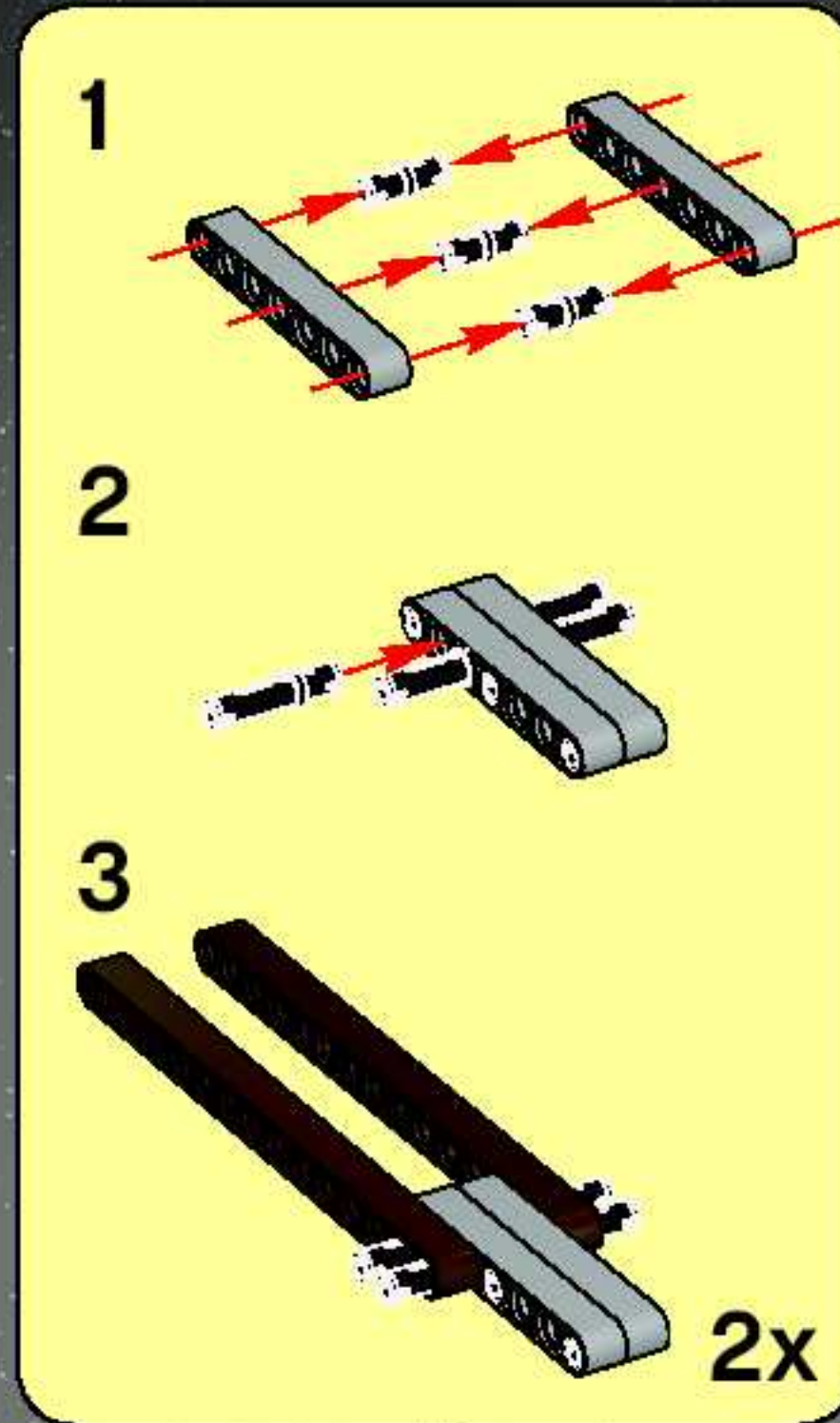



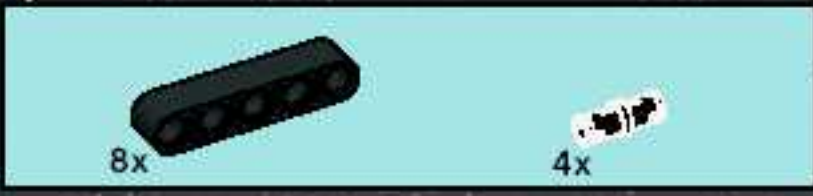

11





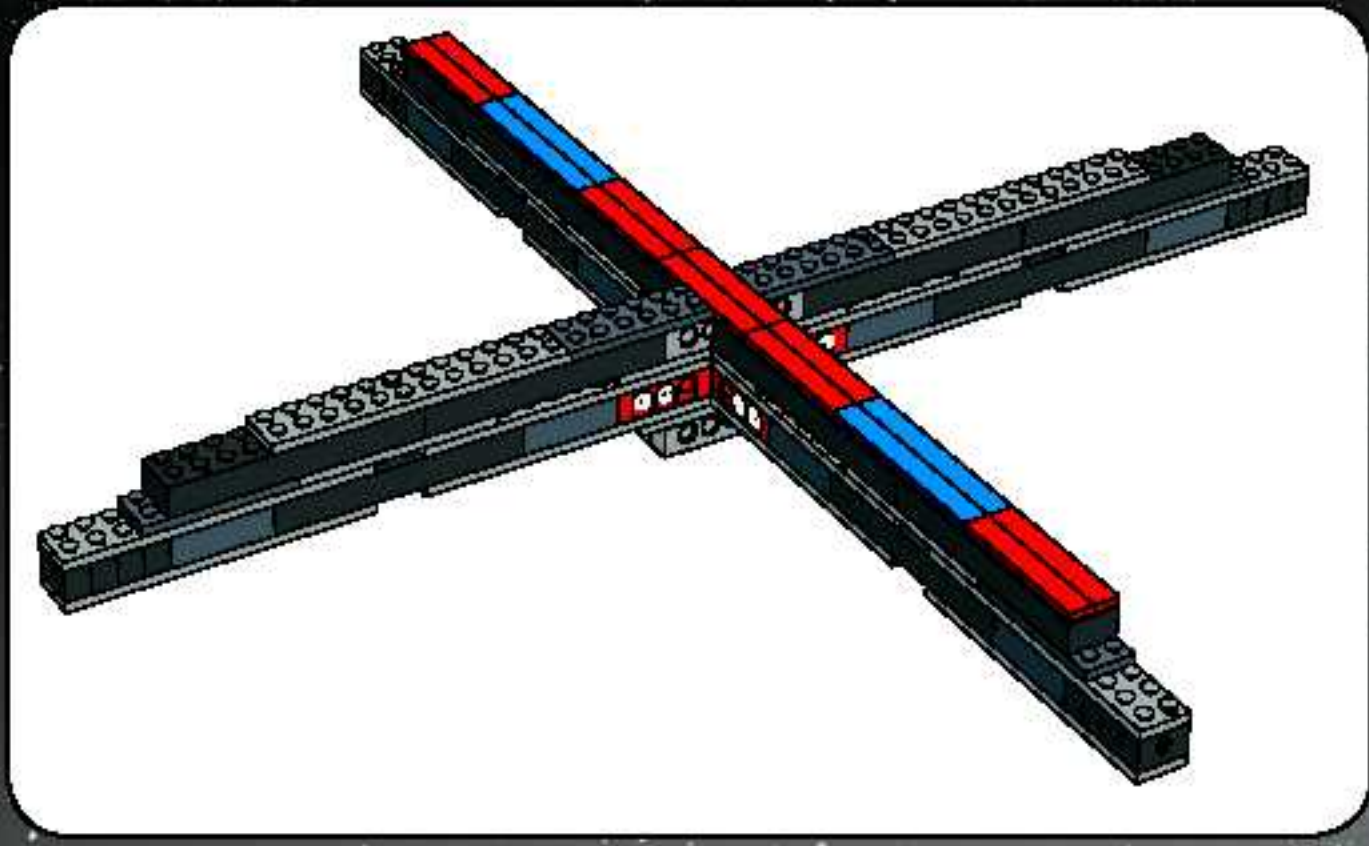

1



2

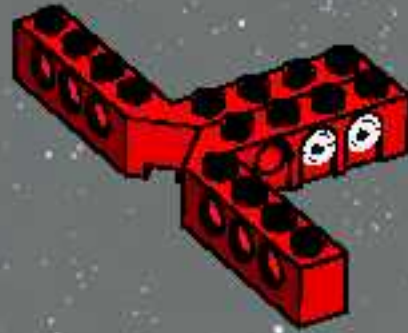

3

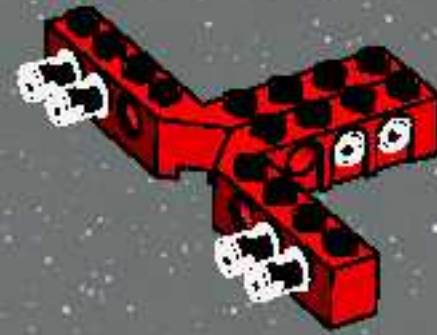

4

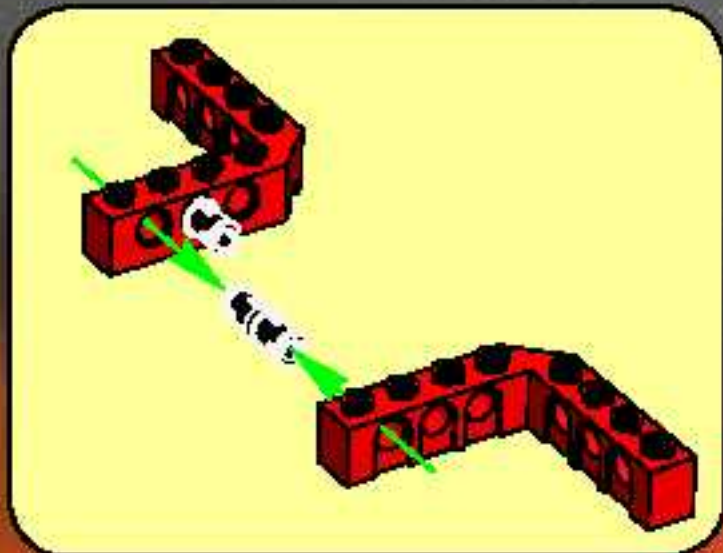



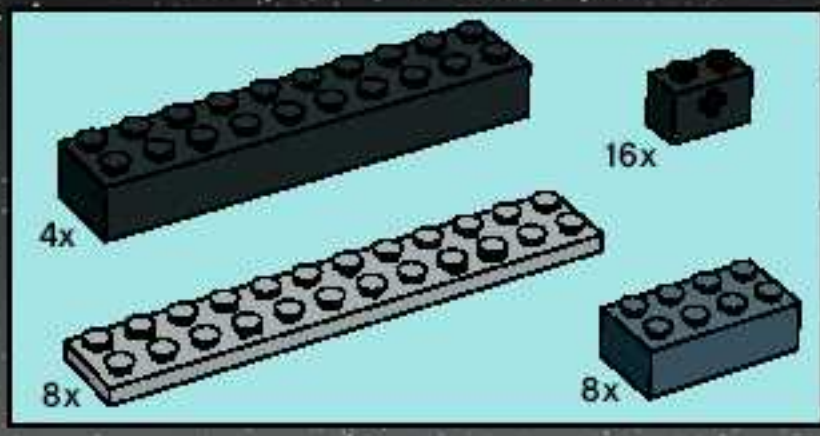

5

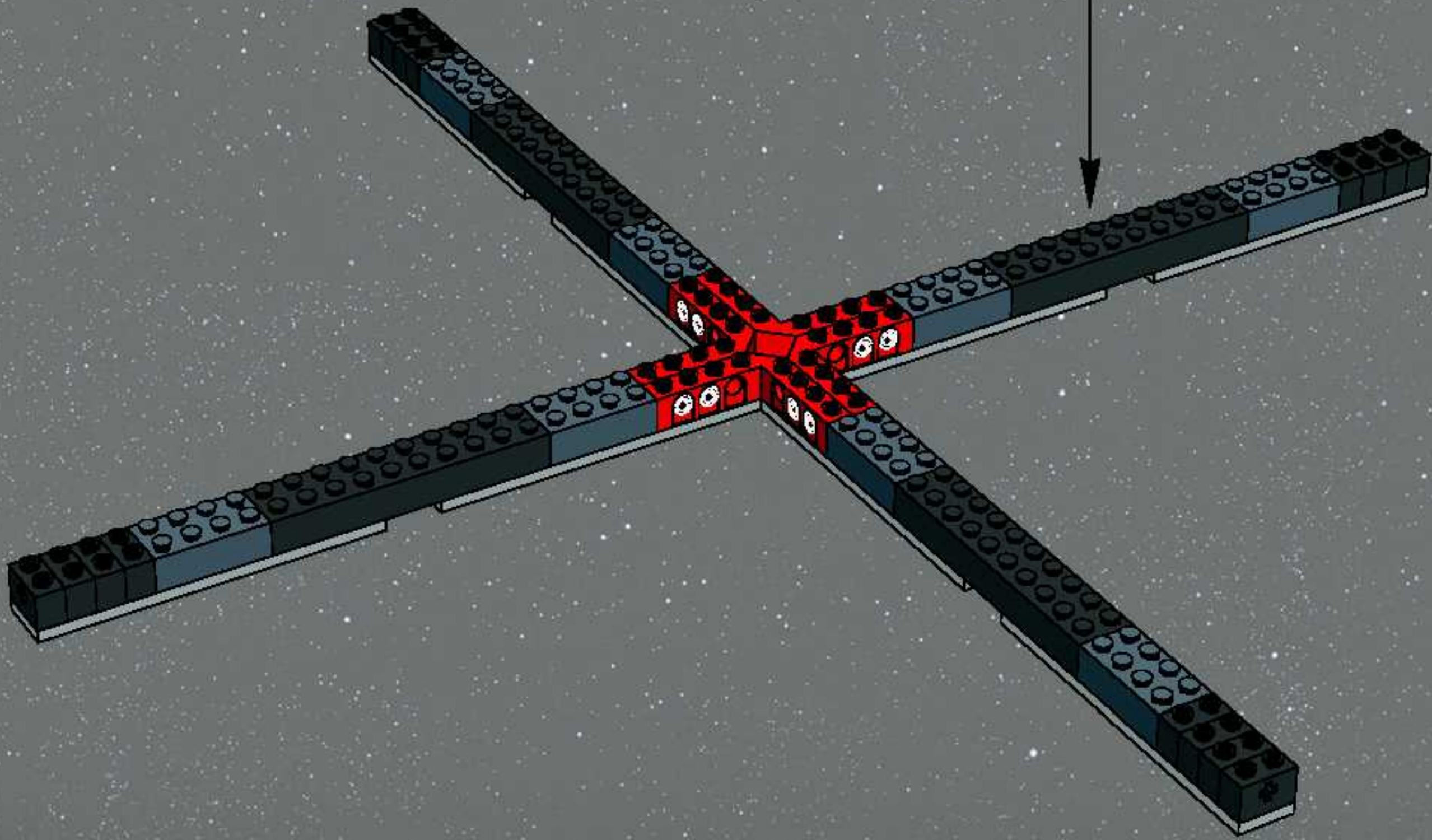
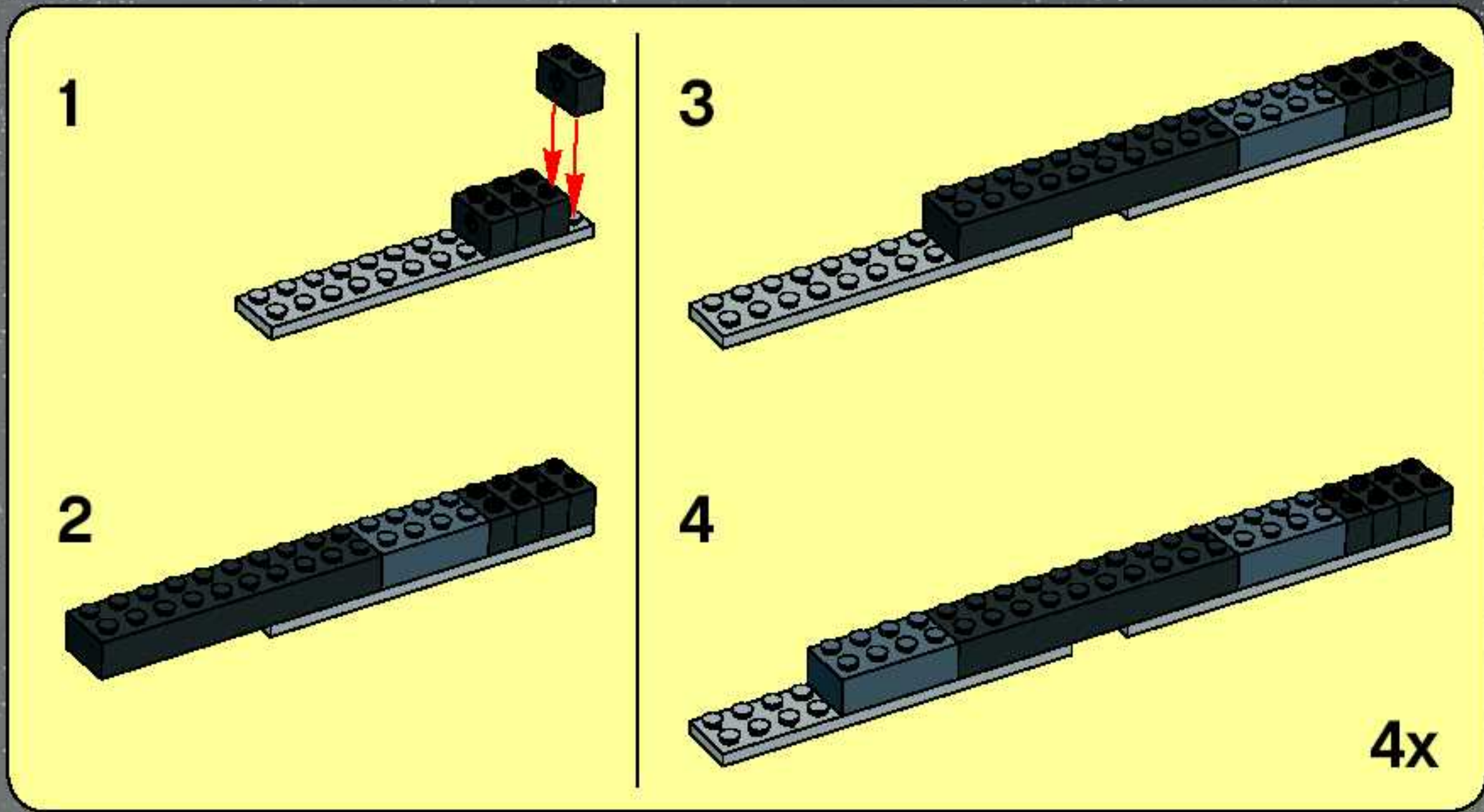



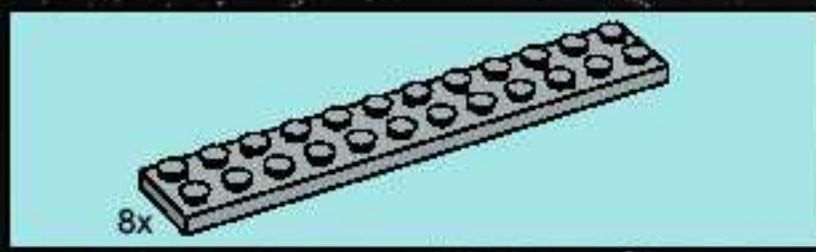

6

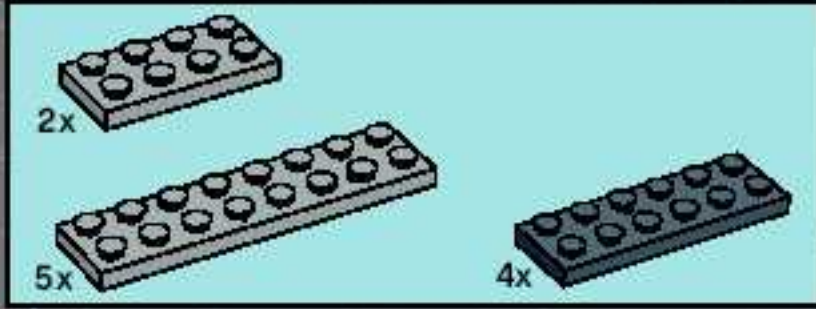
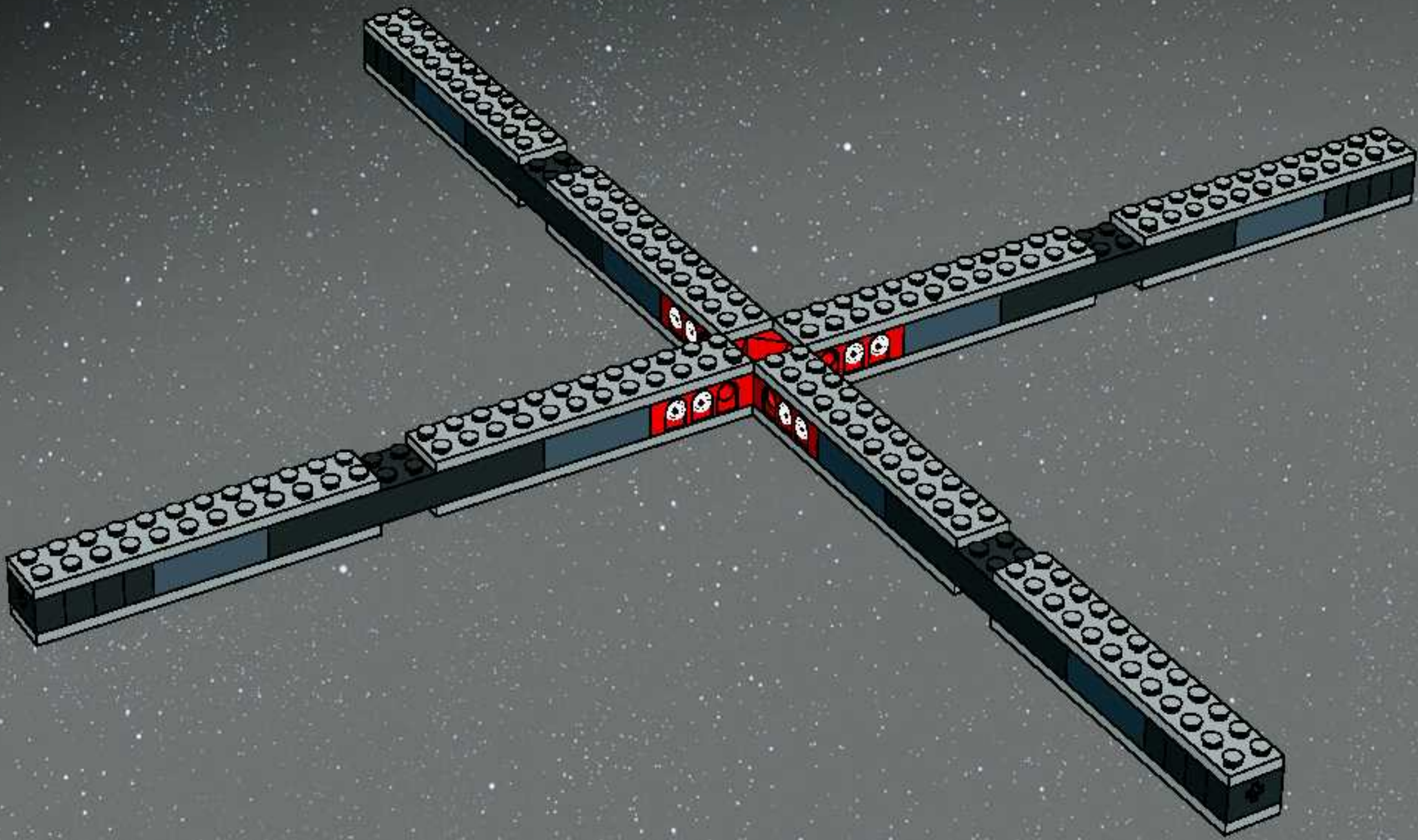

7

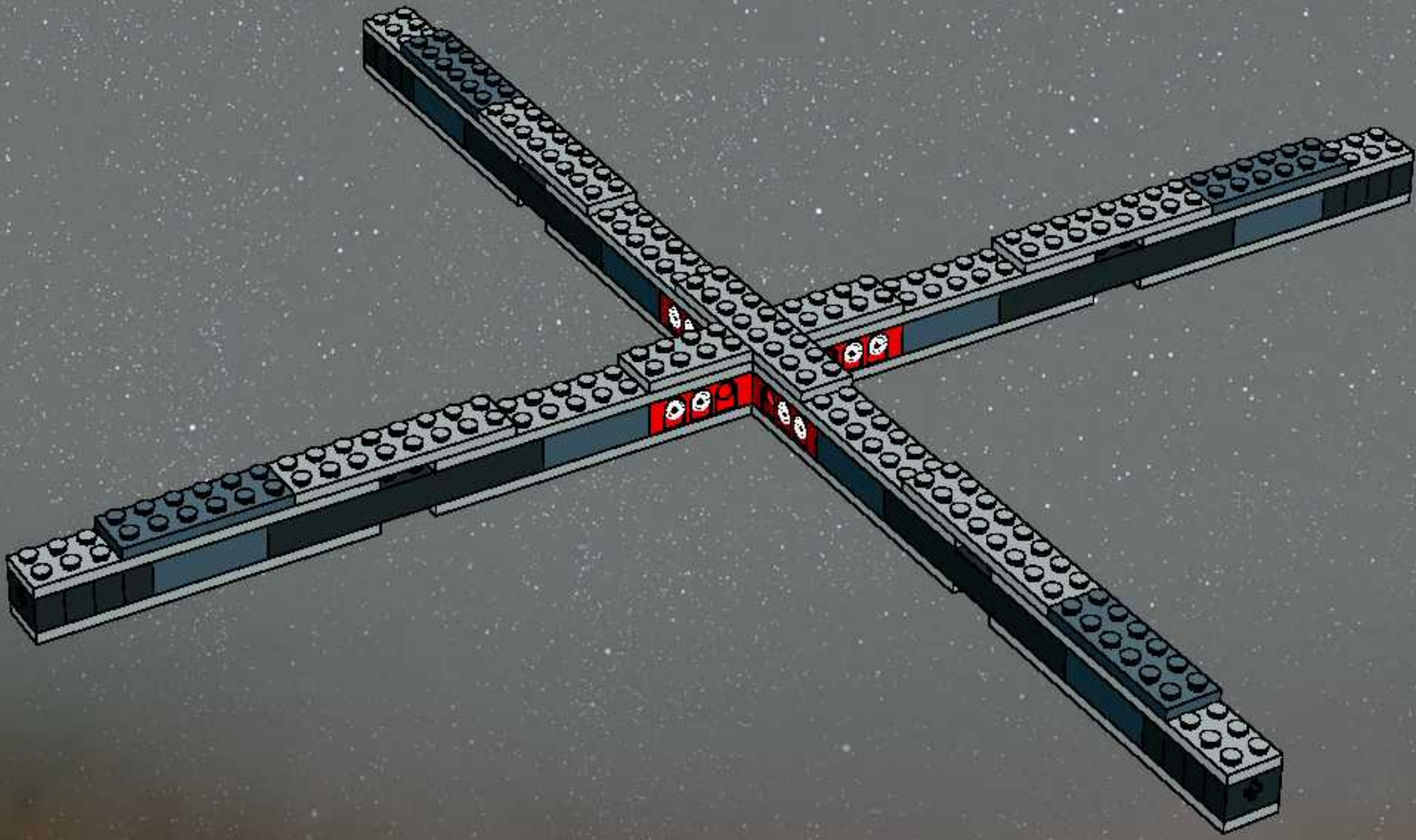



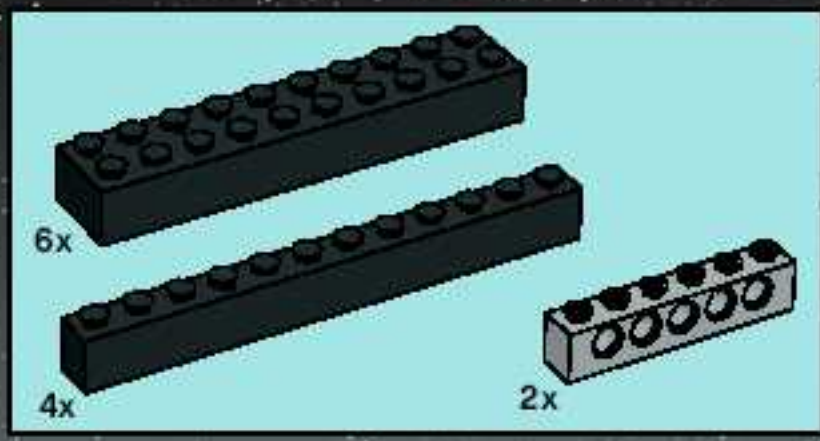

8

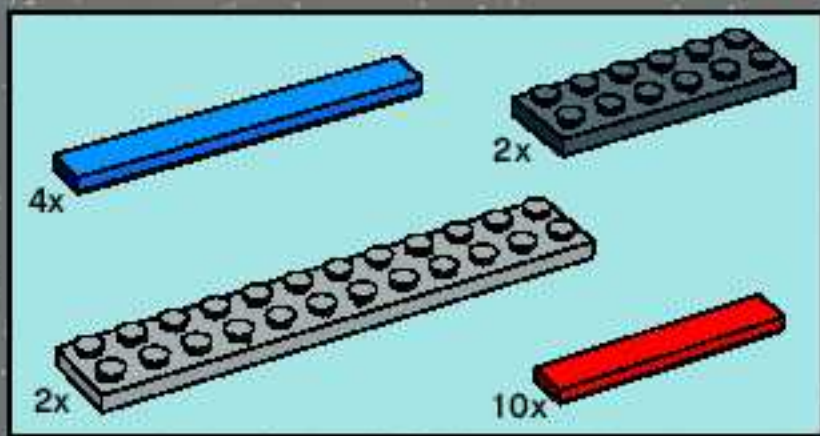
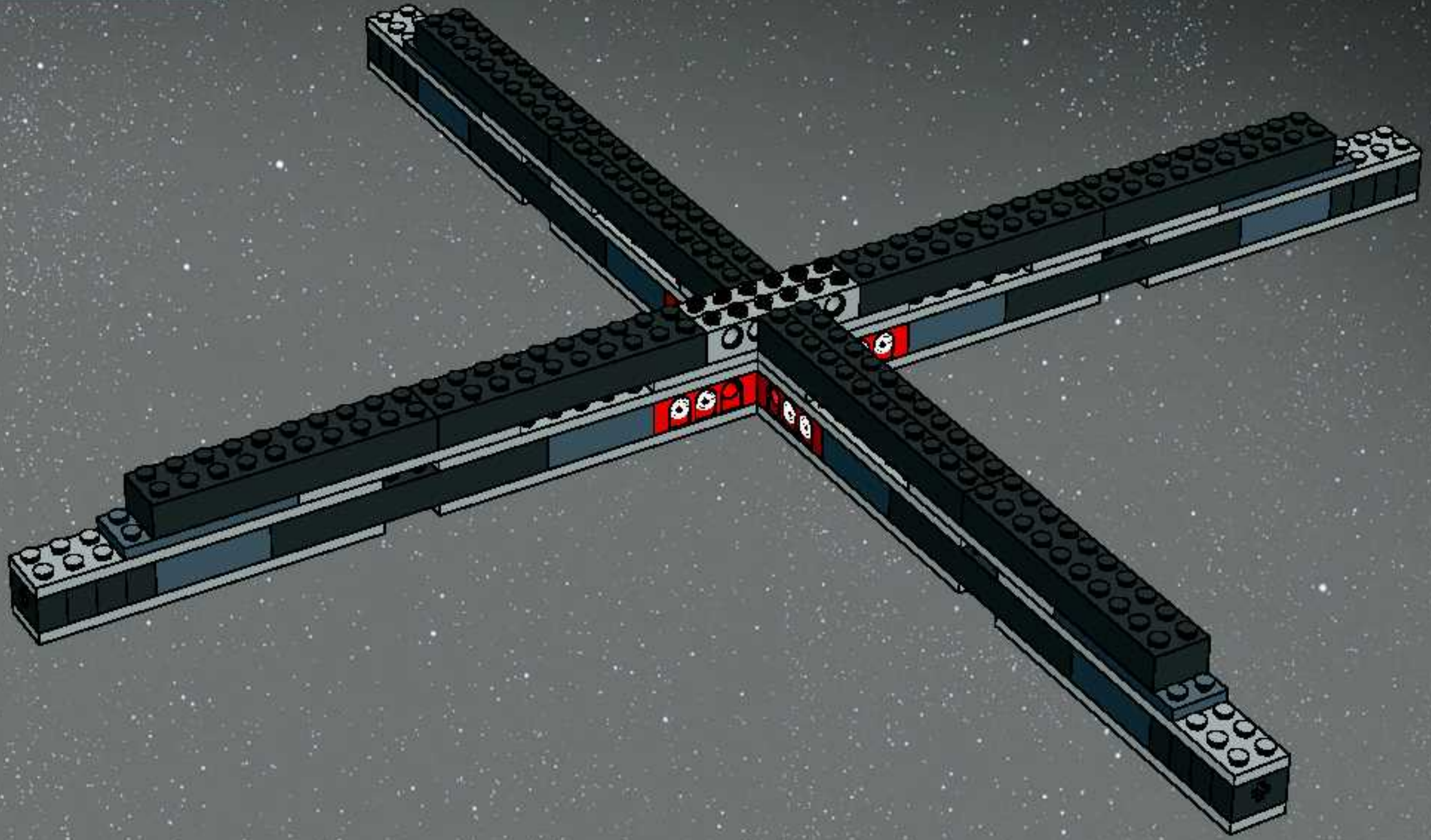

9

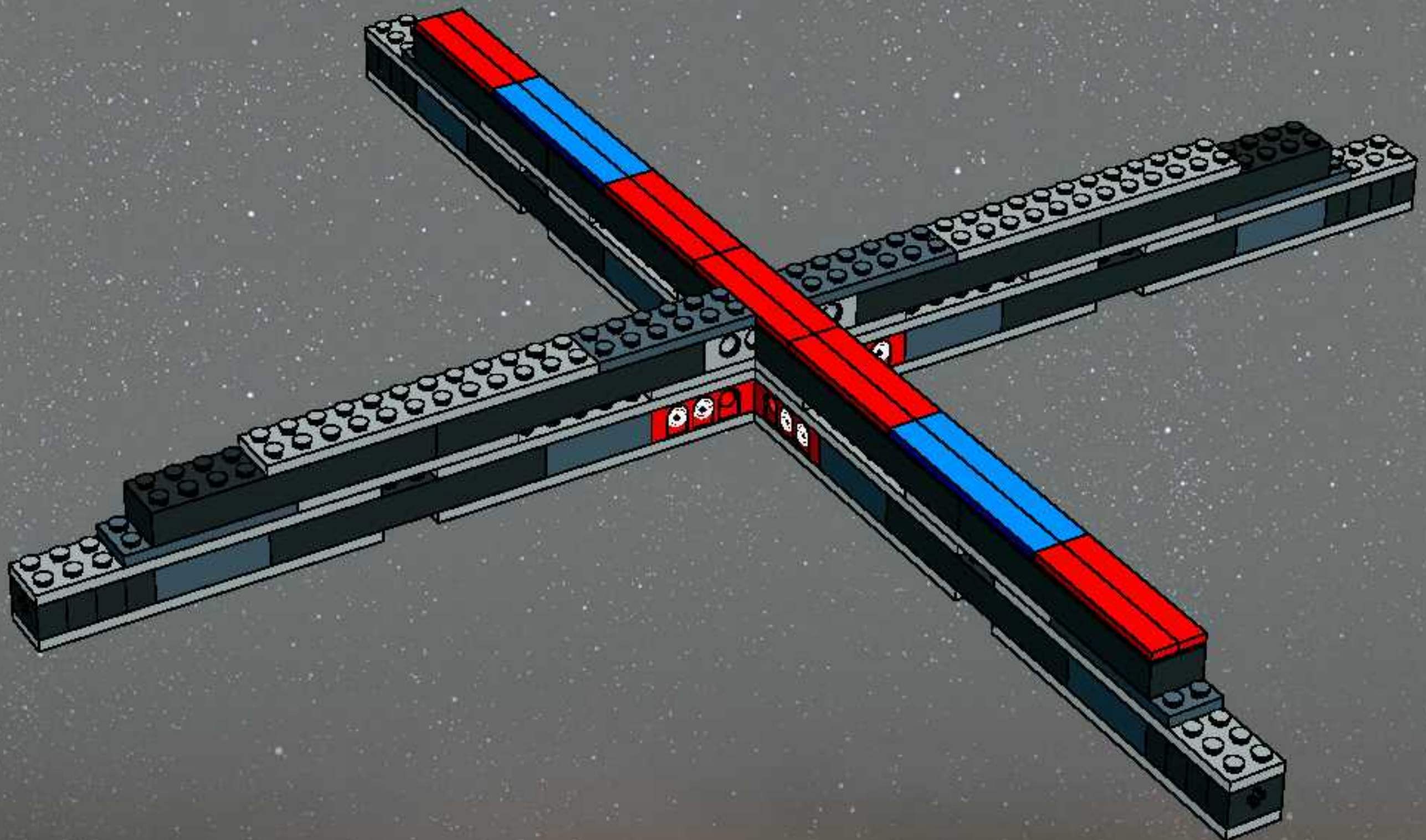





10

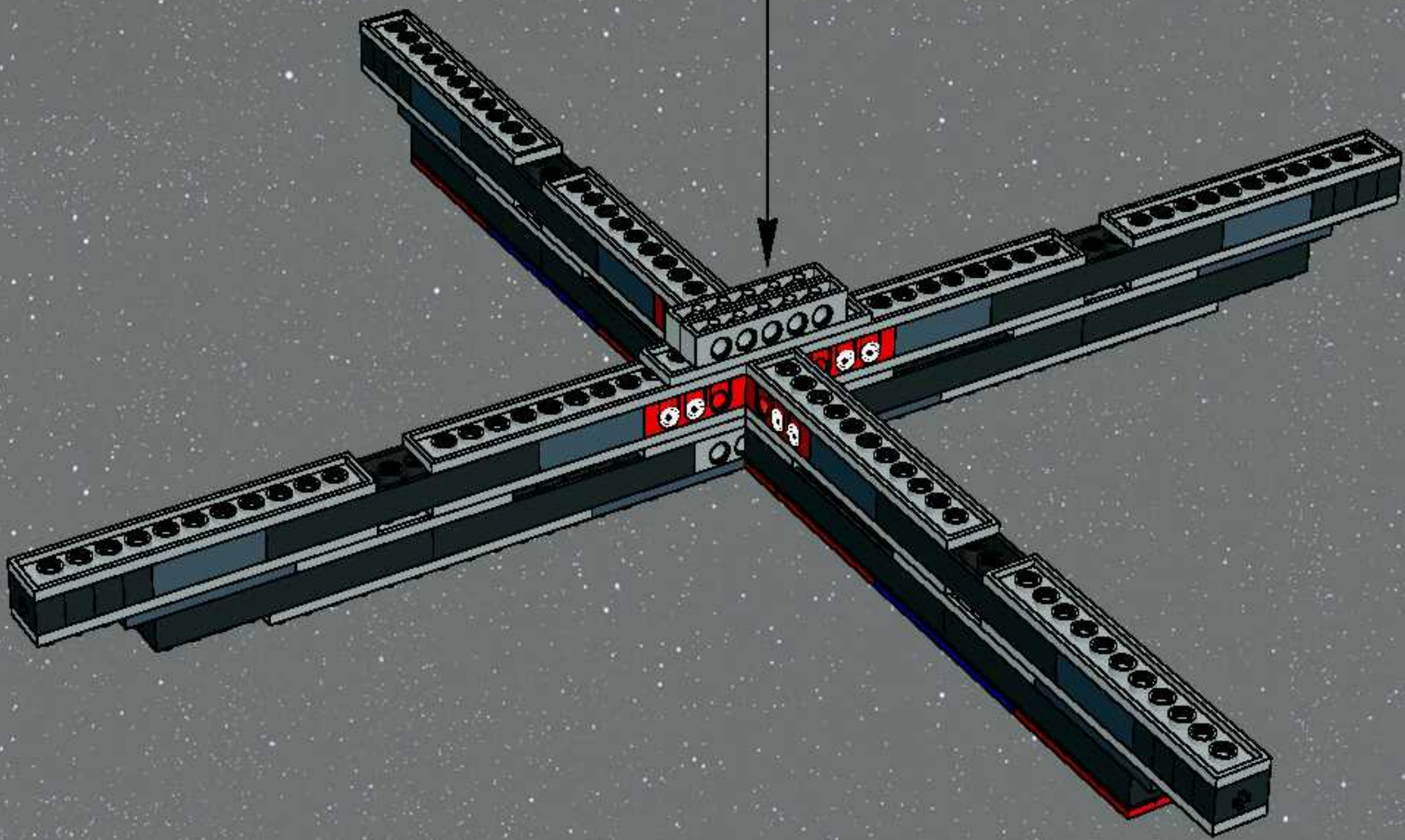
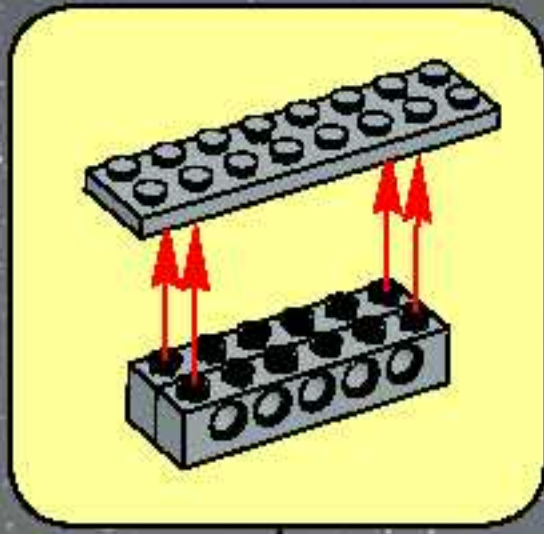





12

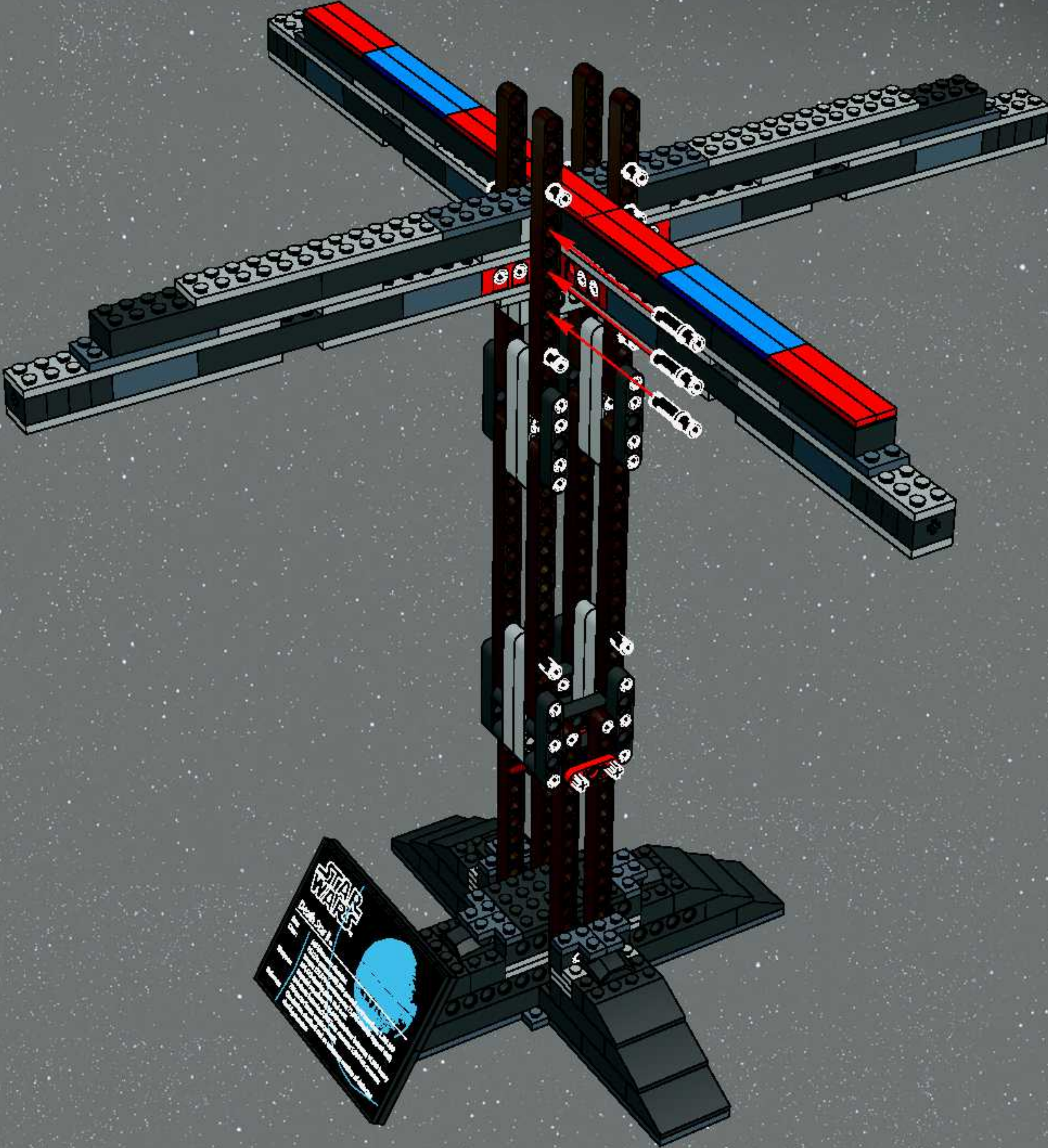



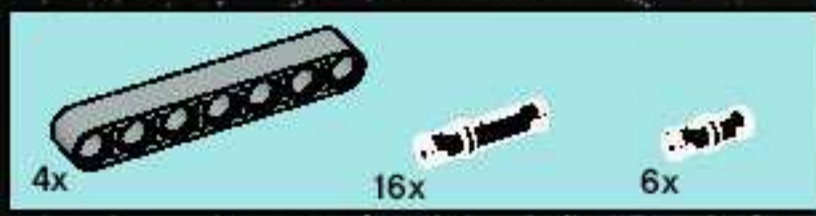

13

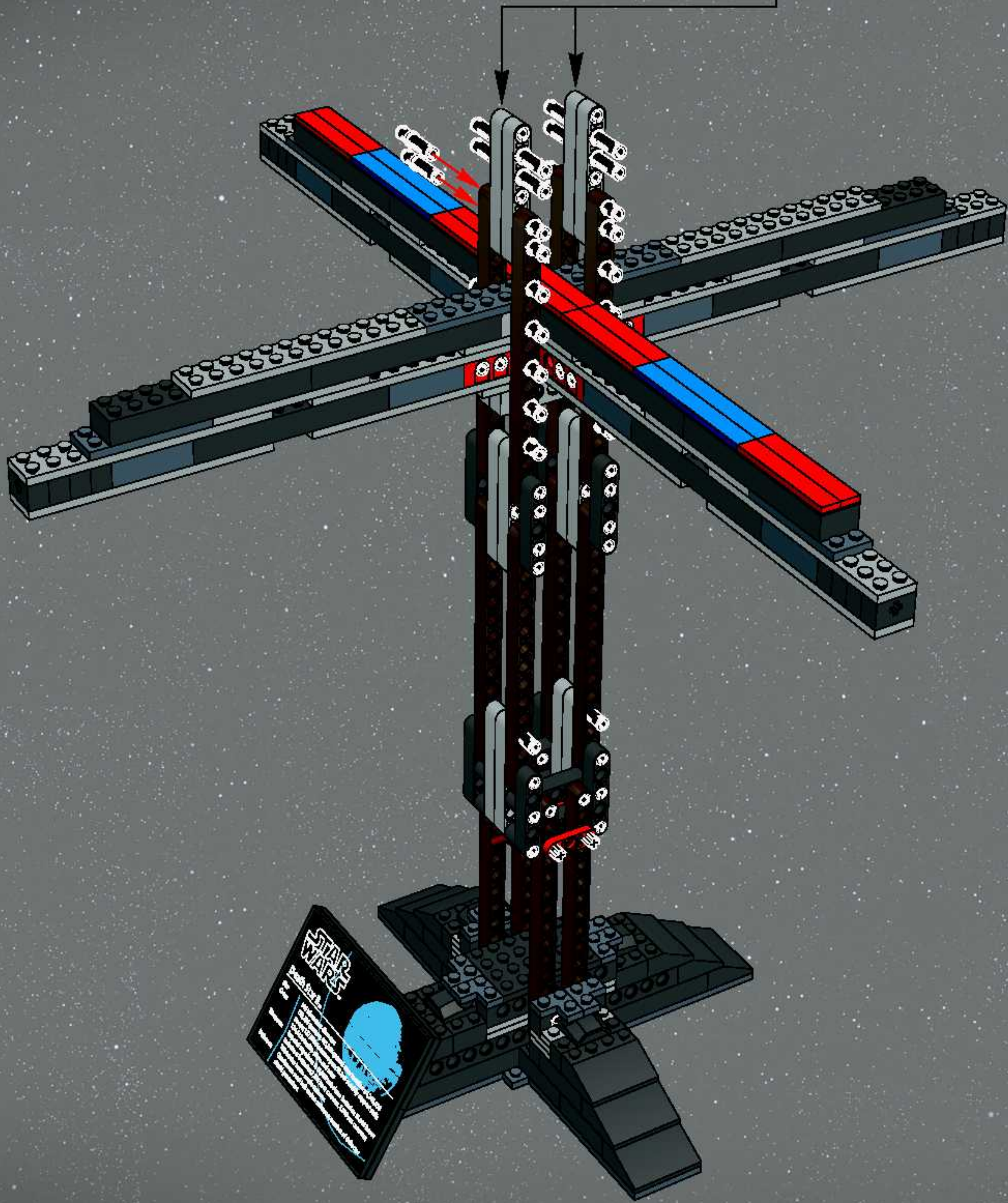
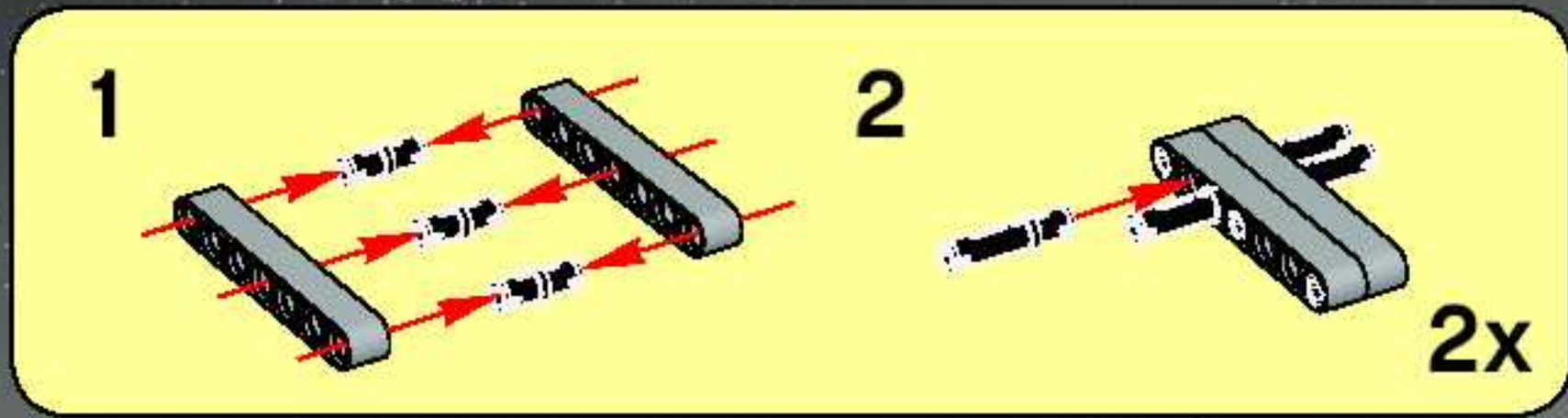



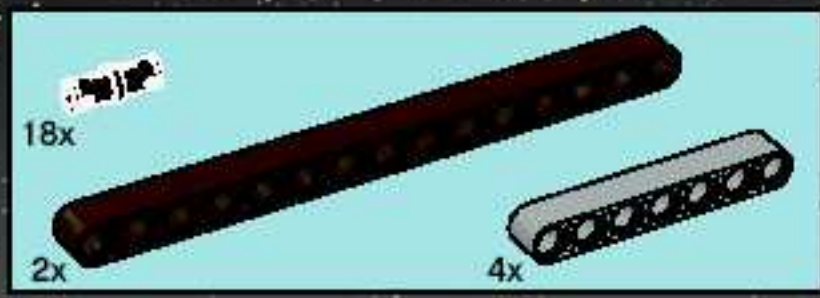

14

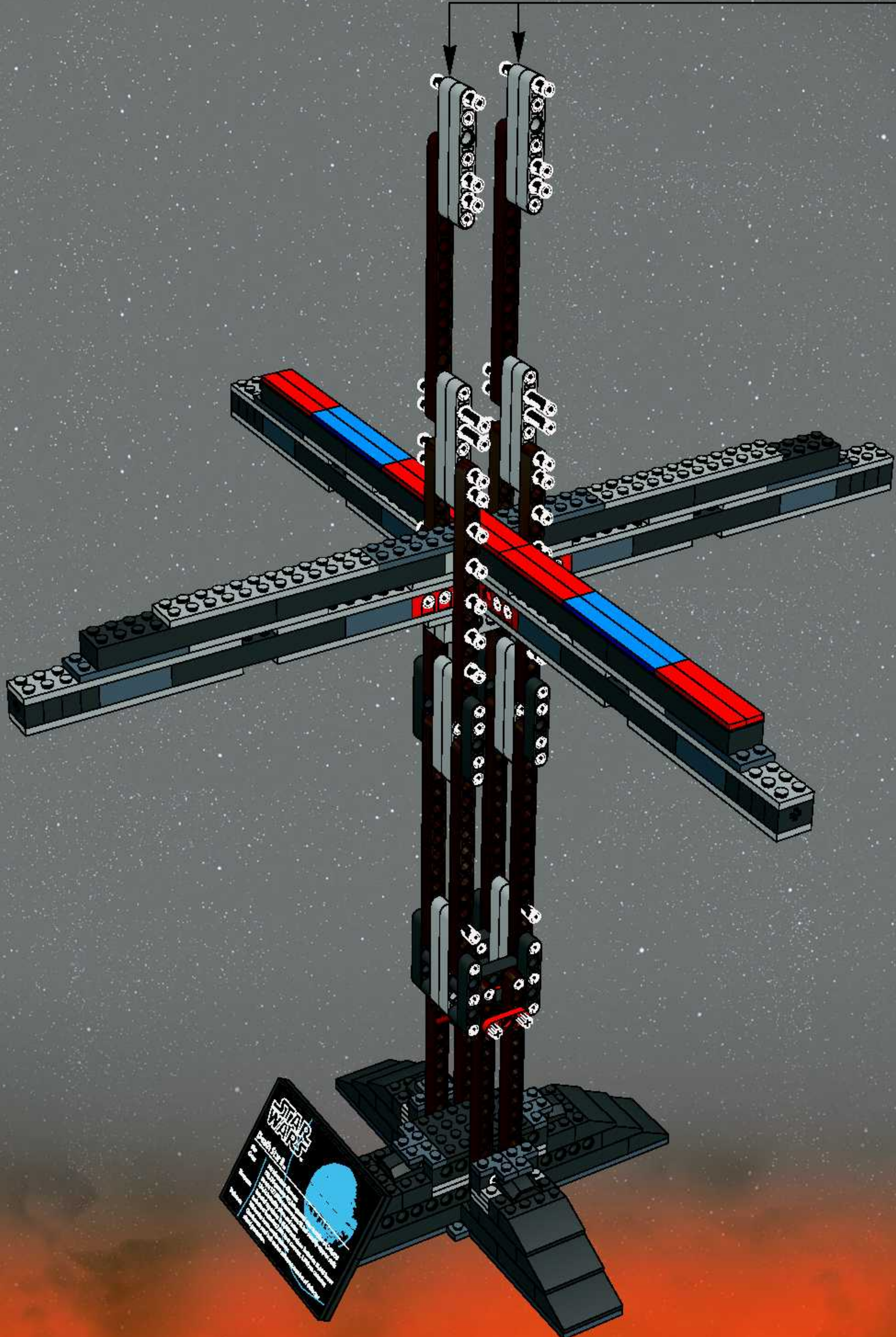
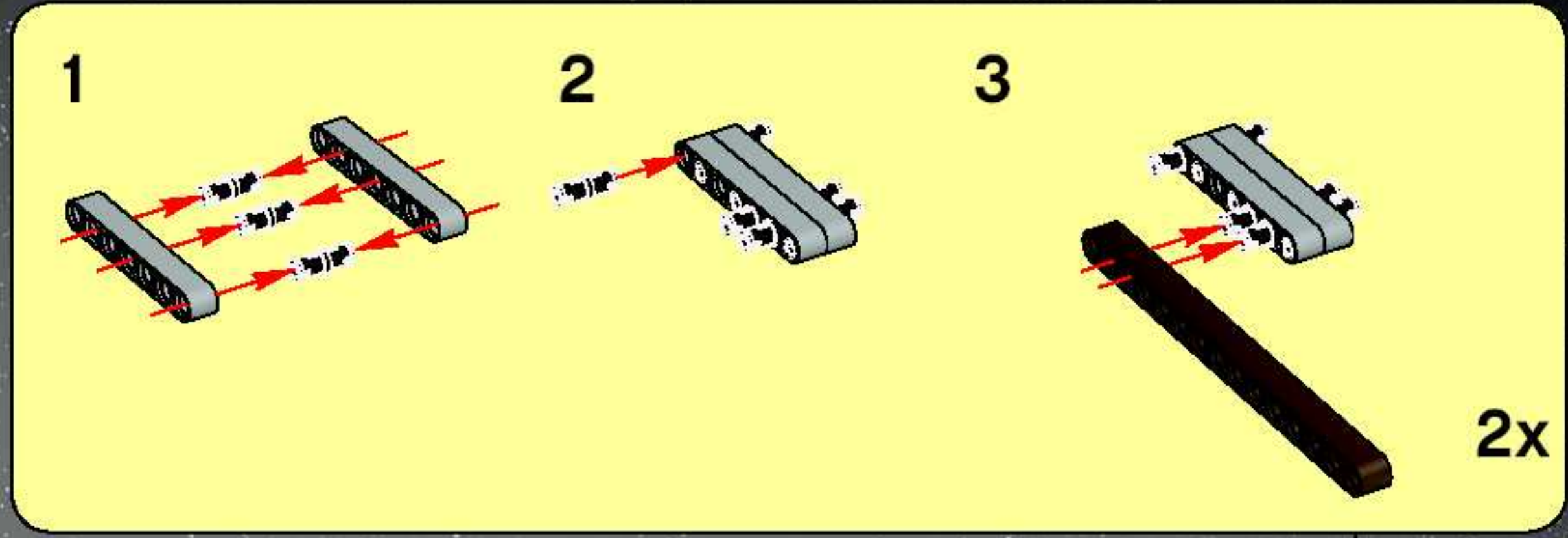



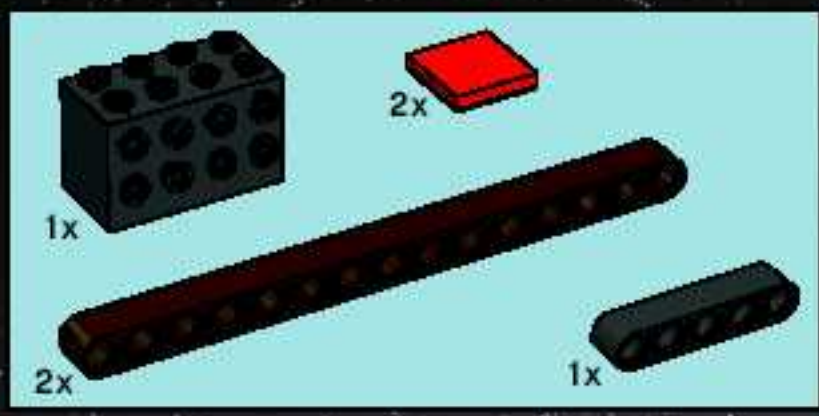

15

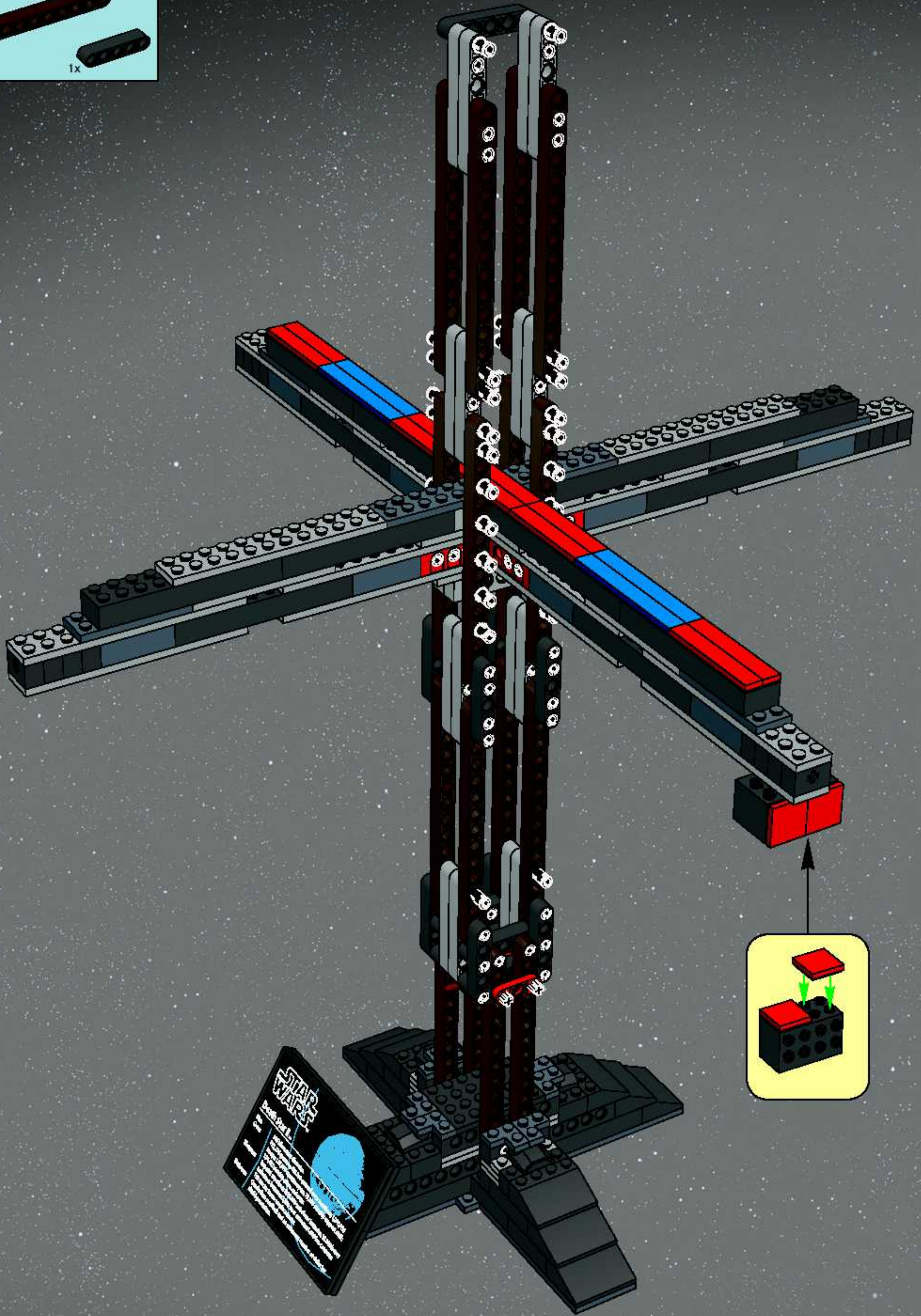





16

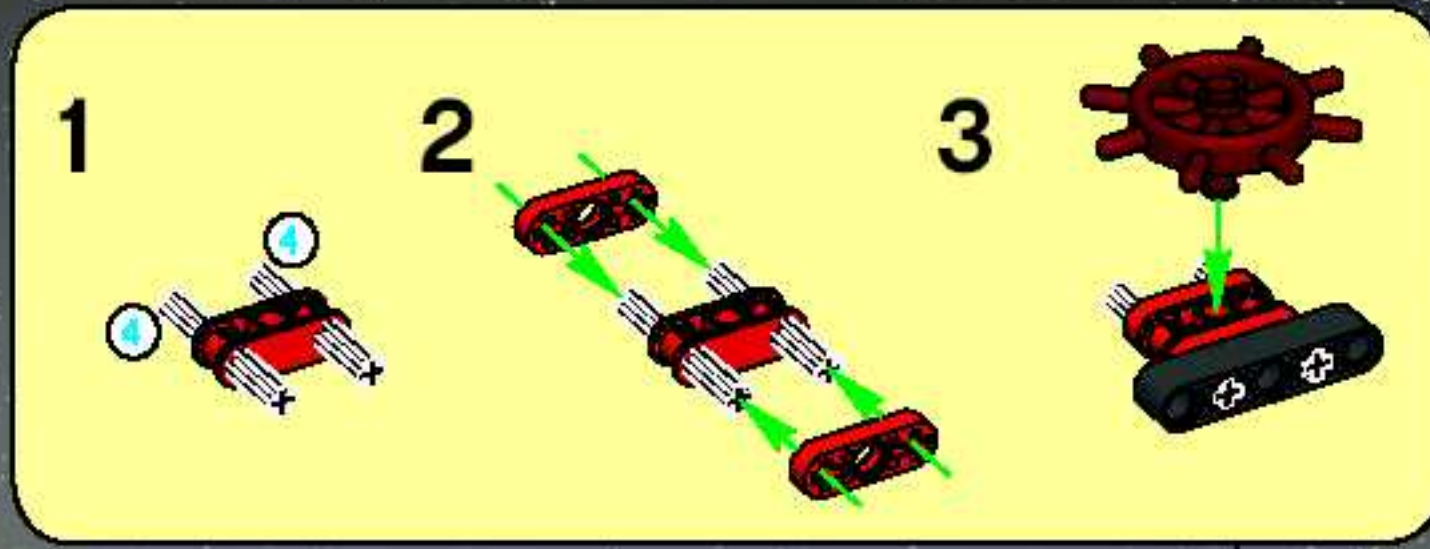



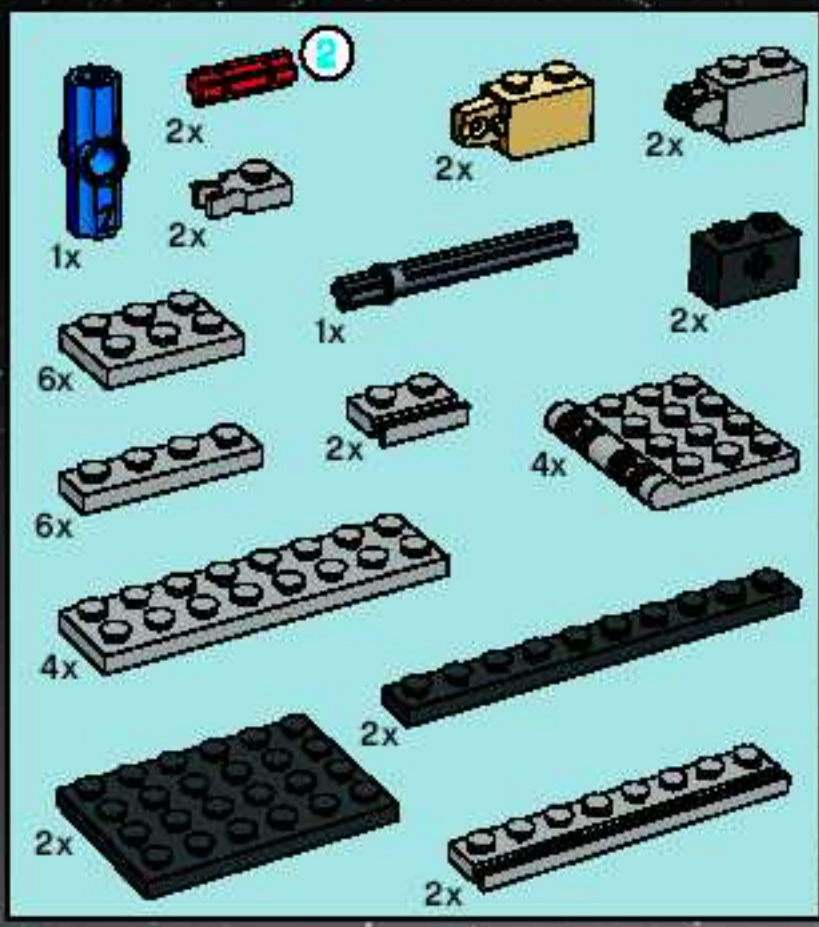

1:1

# 17

1

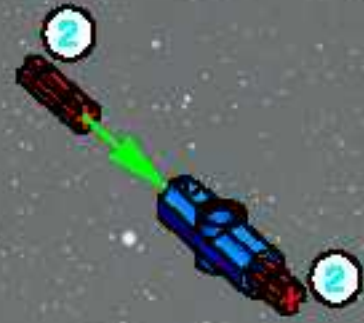

2



3

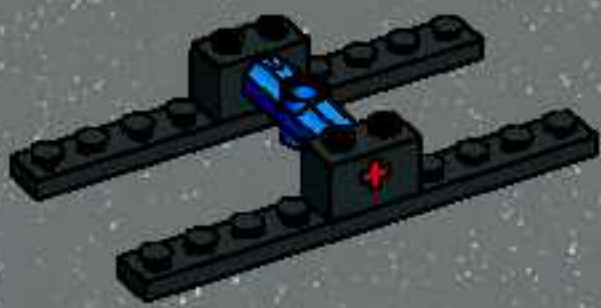

4



5

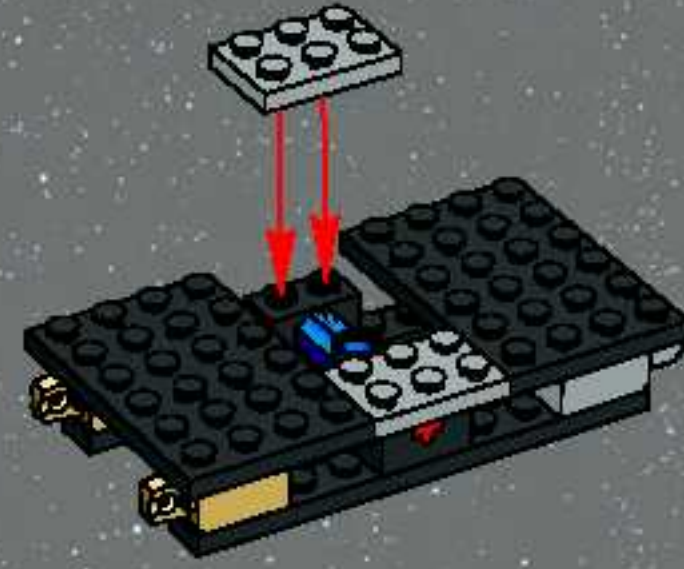

6



7

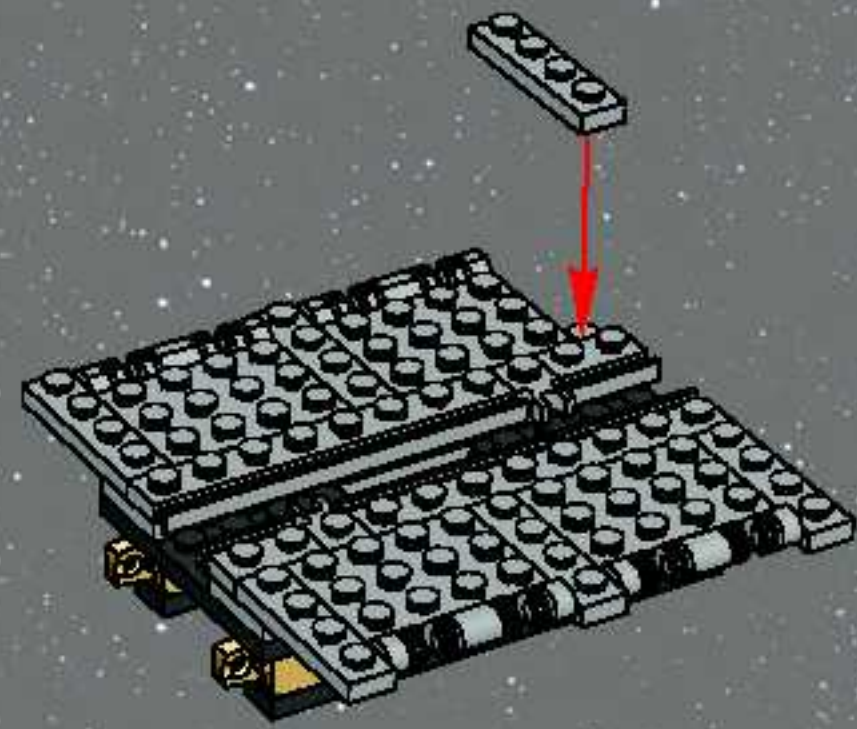

8

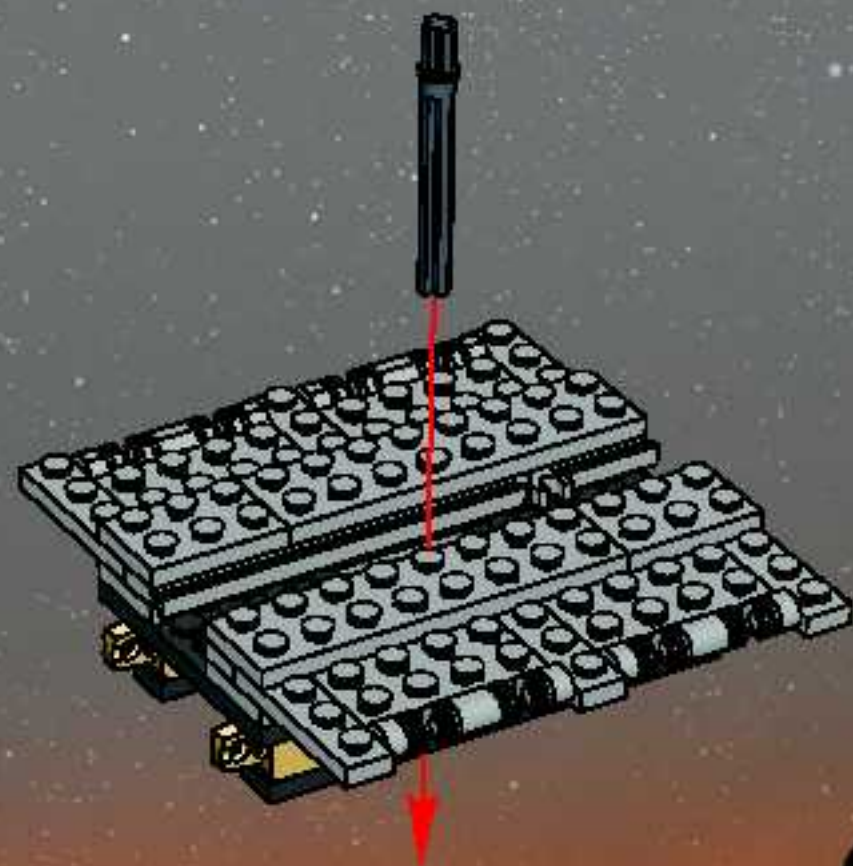

**3x**



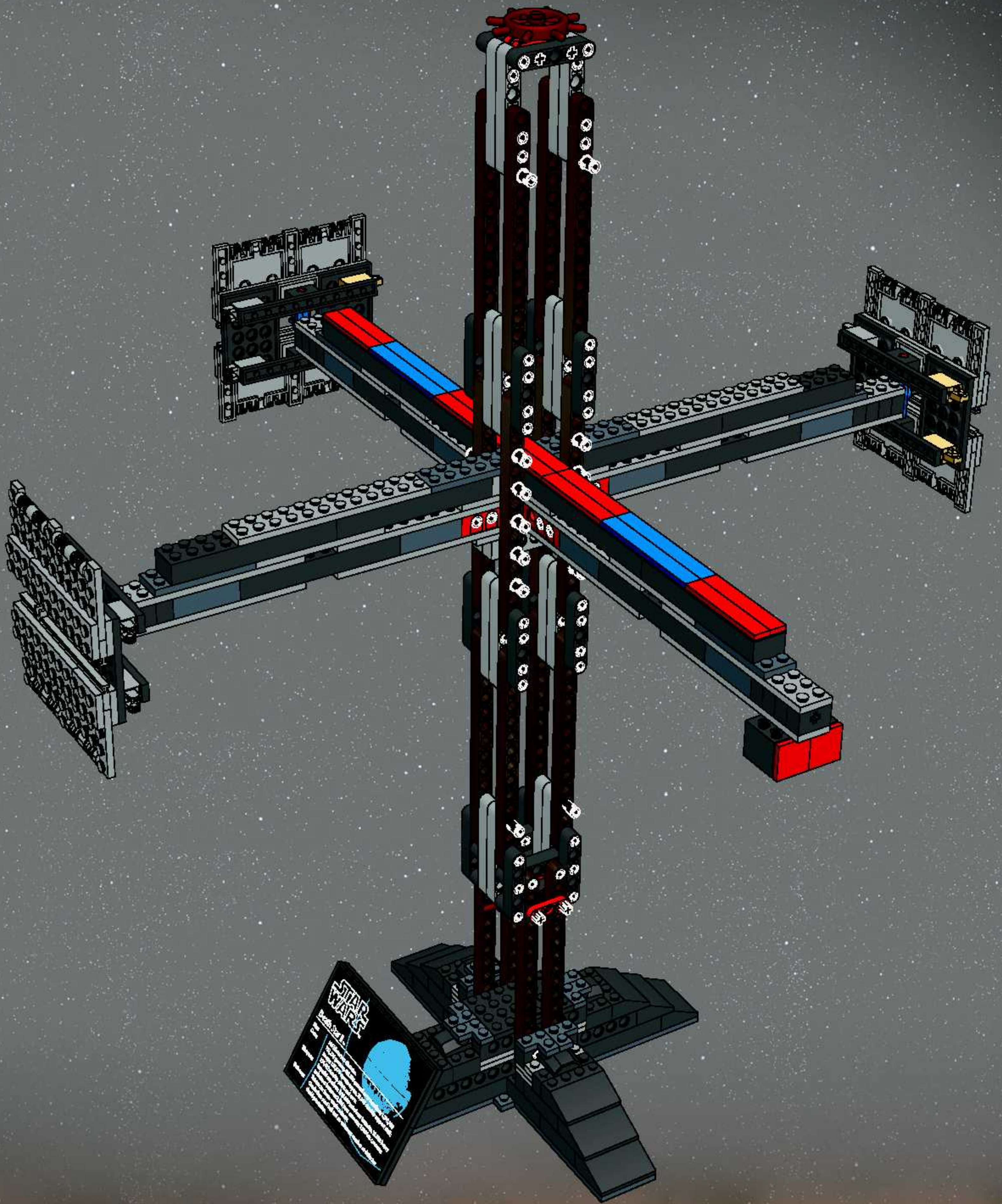



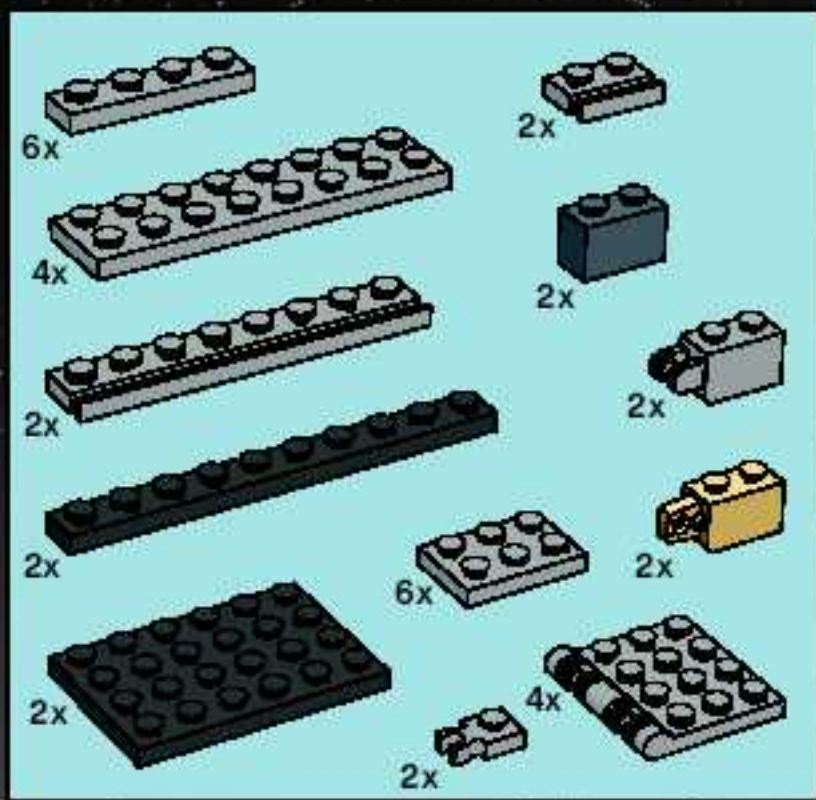

# 18

1

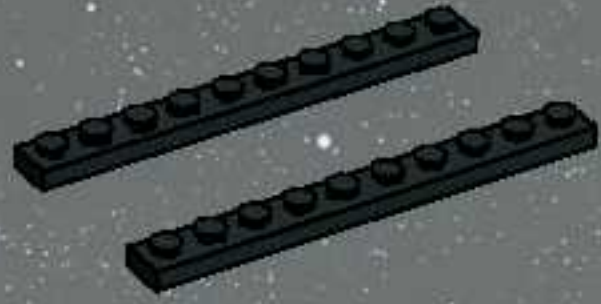

2

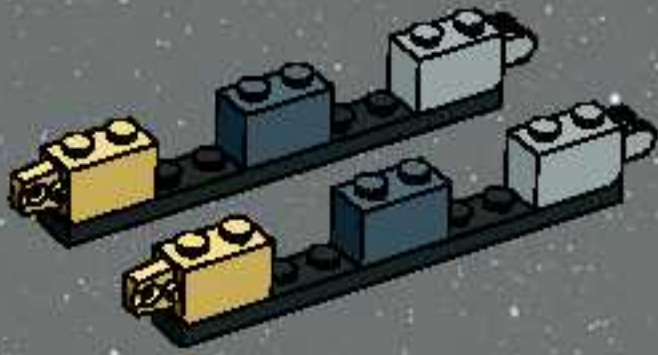

3

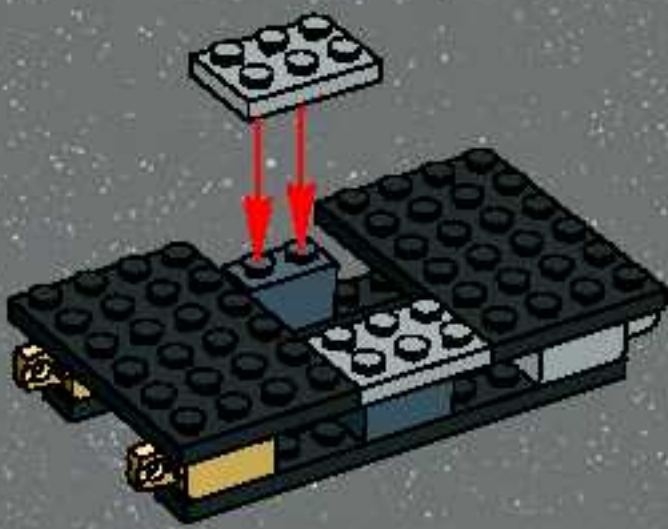

4



5

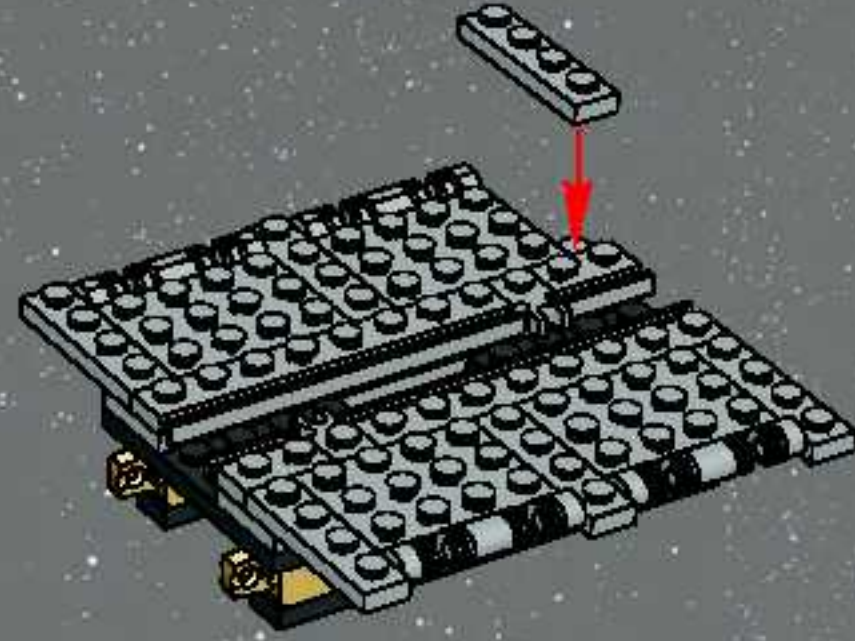

6



6x

7

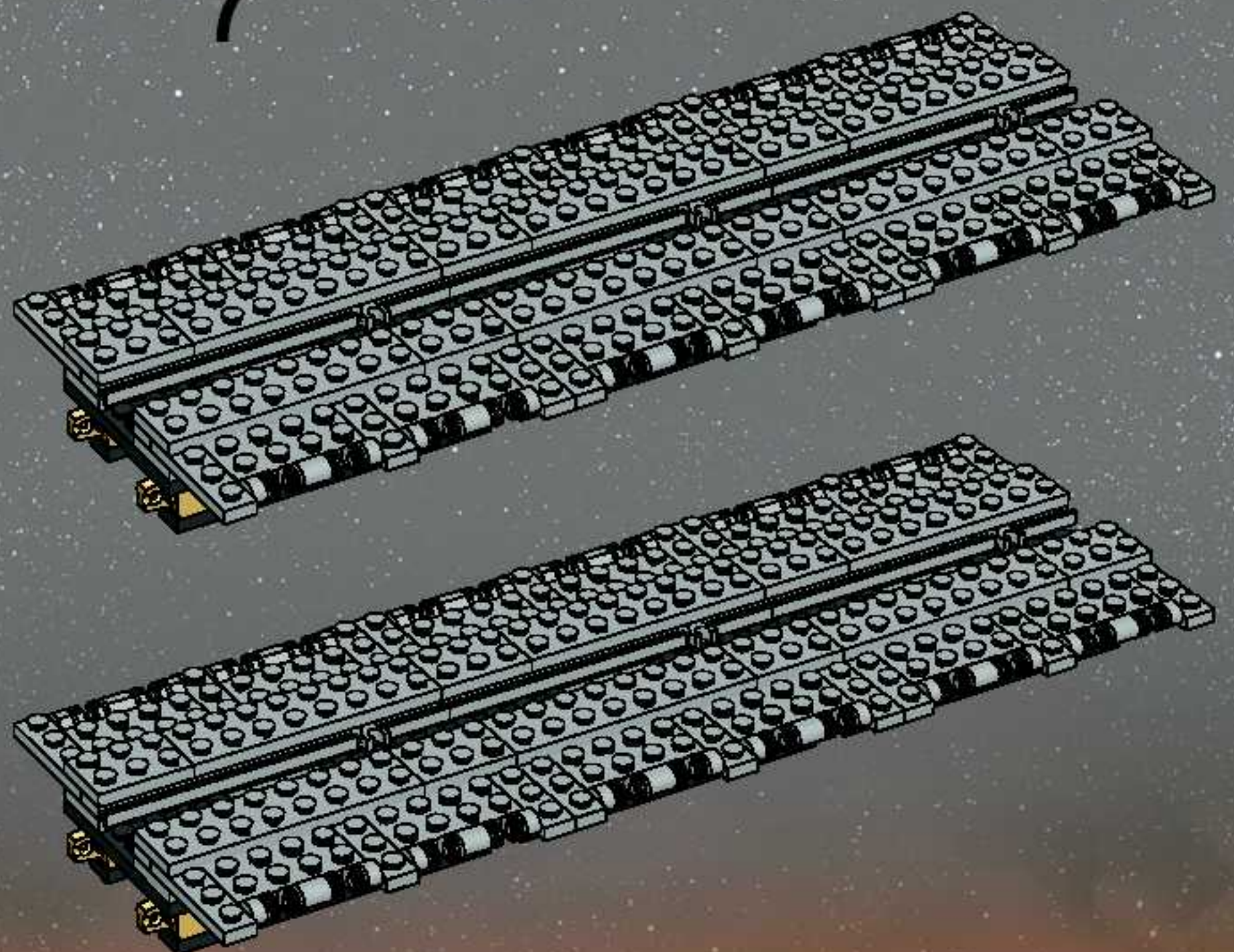



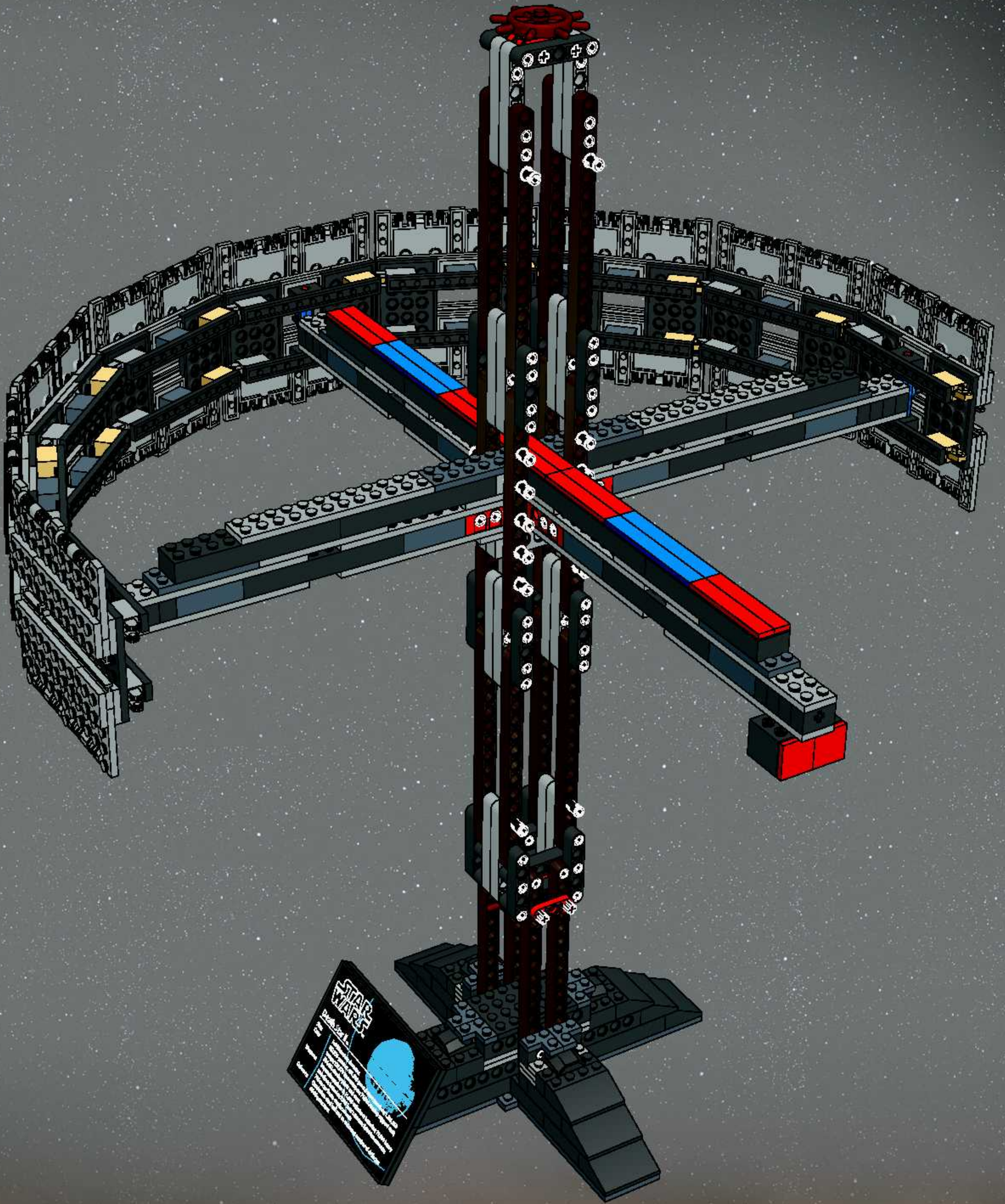



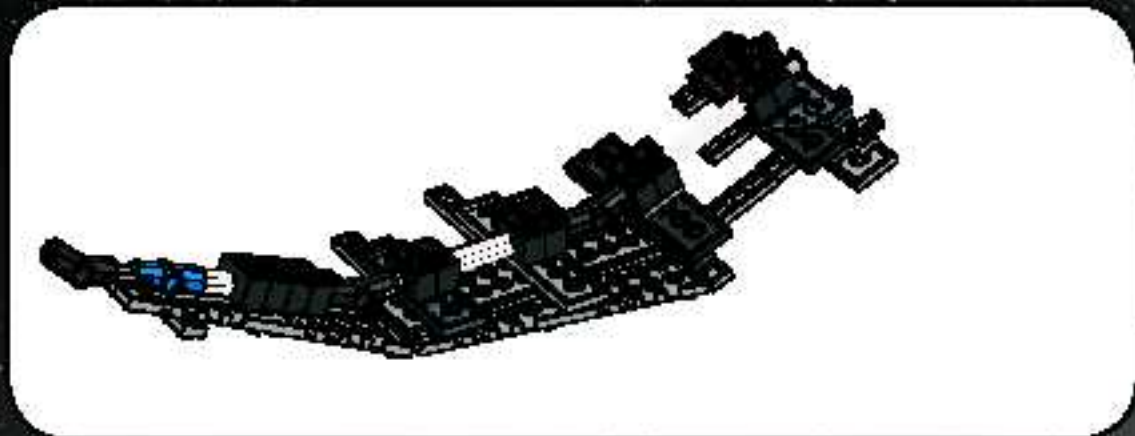

1



2



3

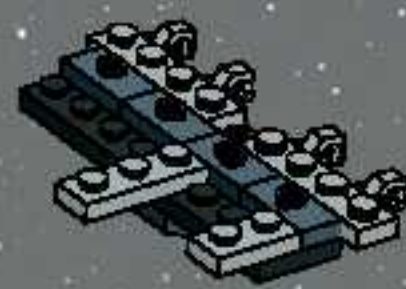

4

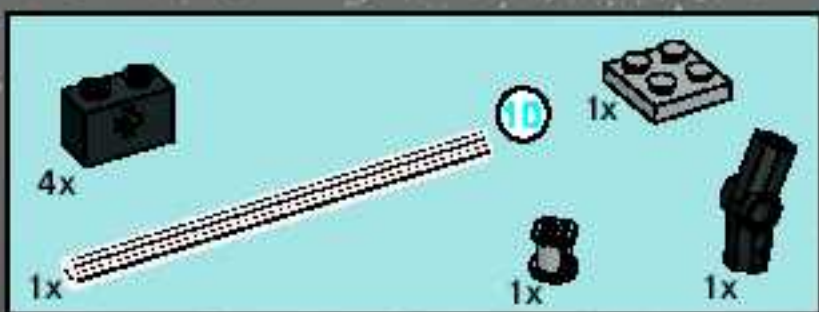
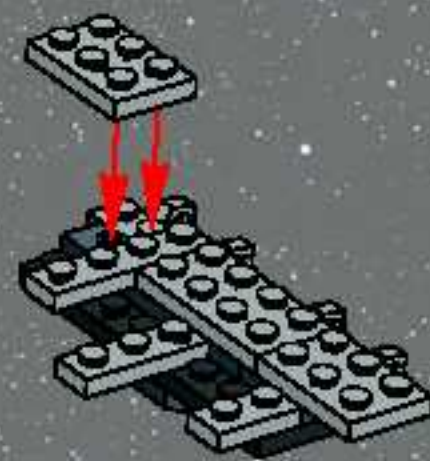

5

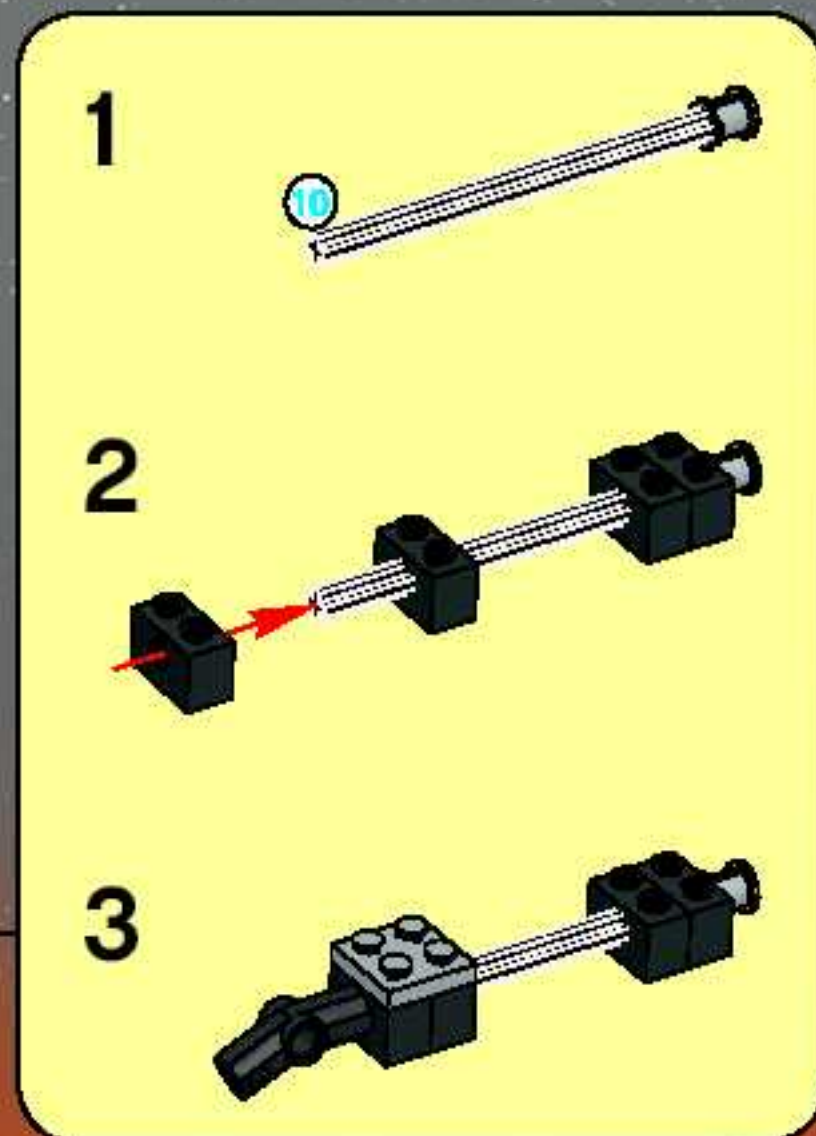
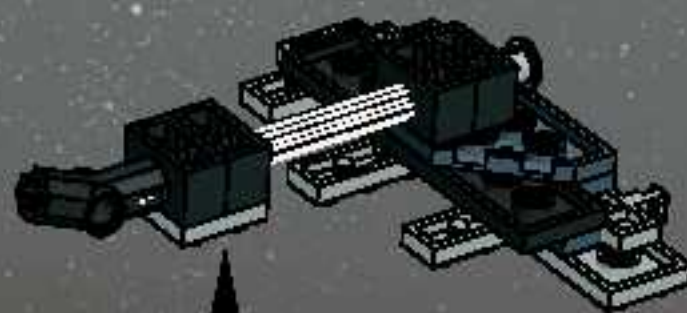



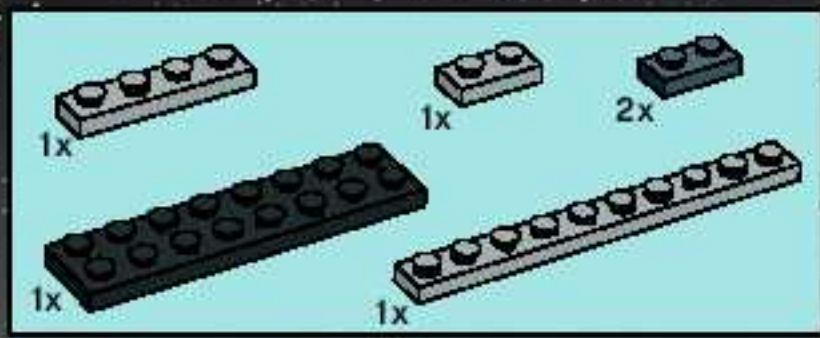

6

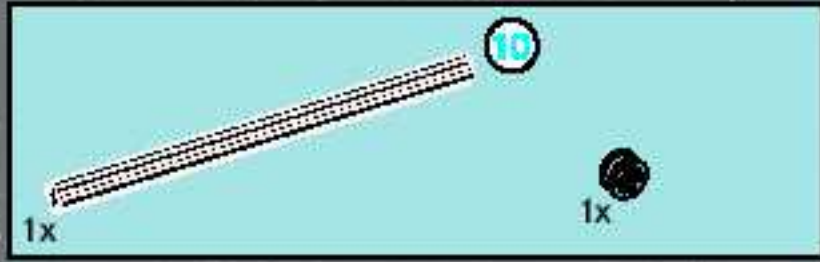
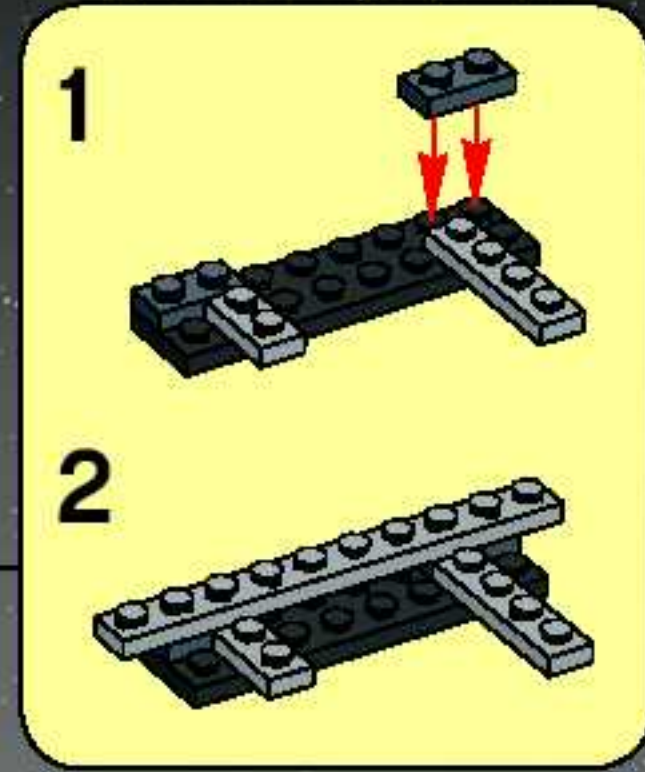
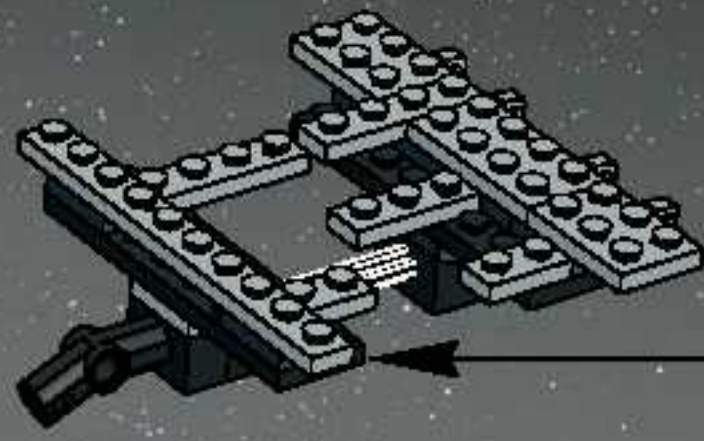

7

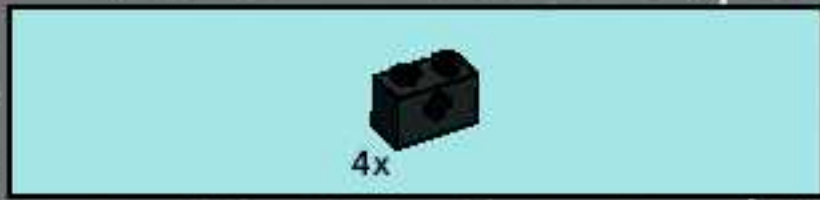
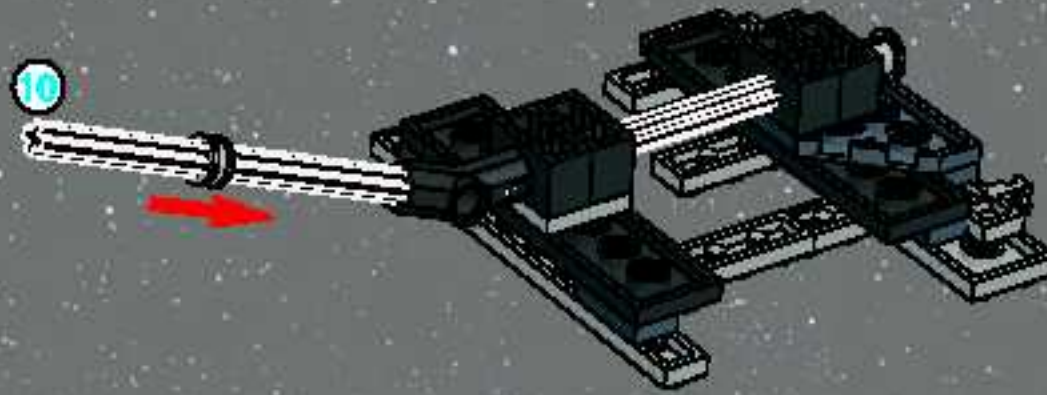

8

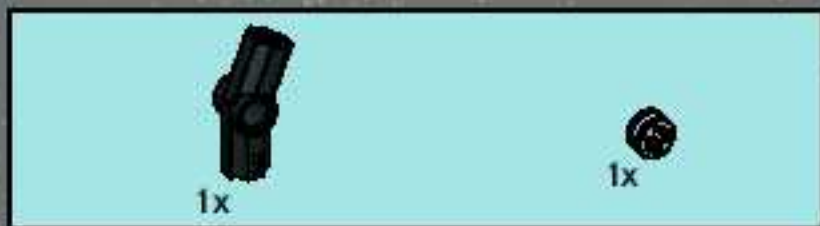
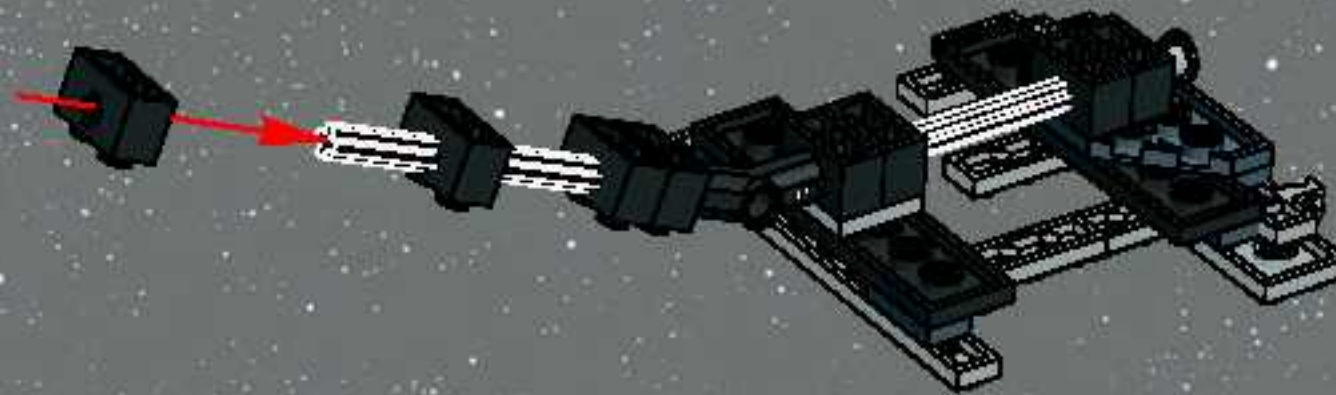

9





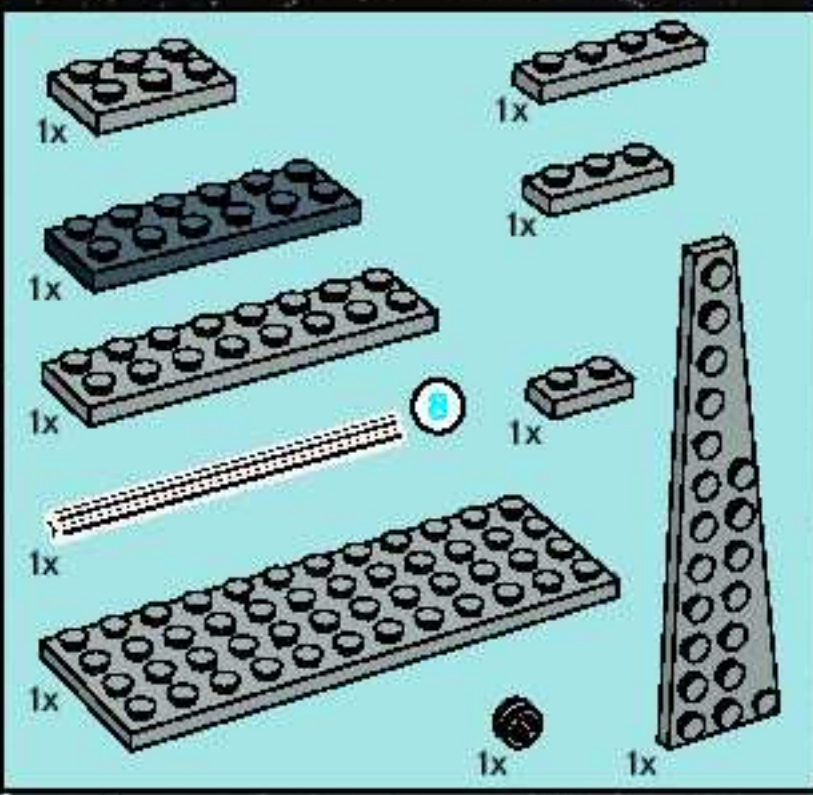

10

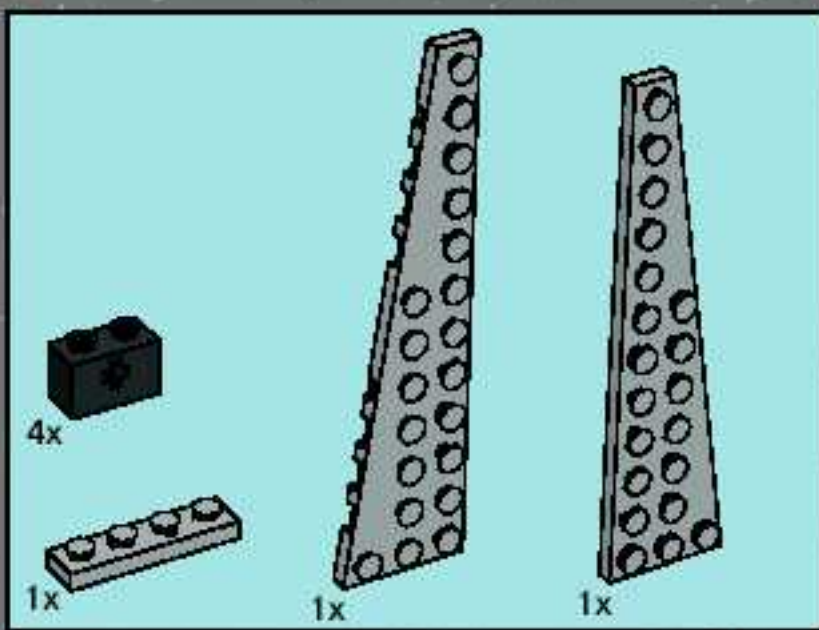
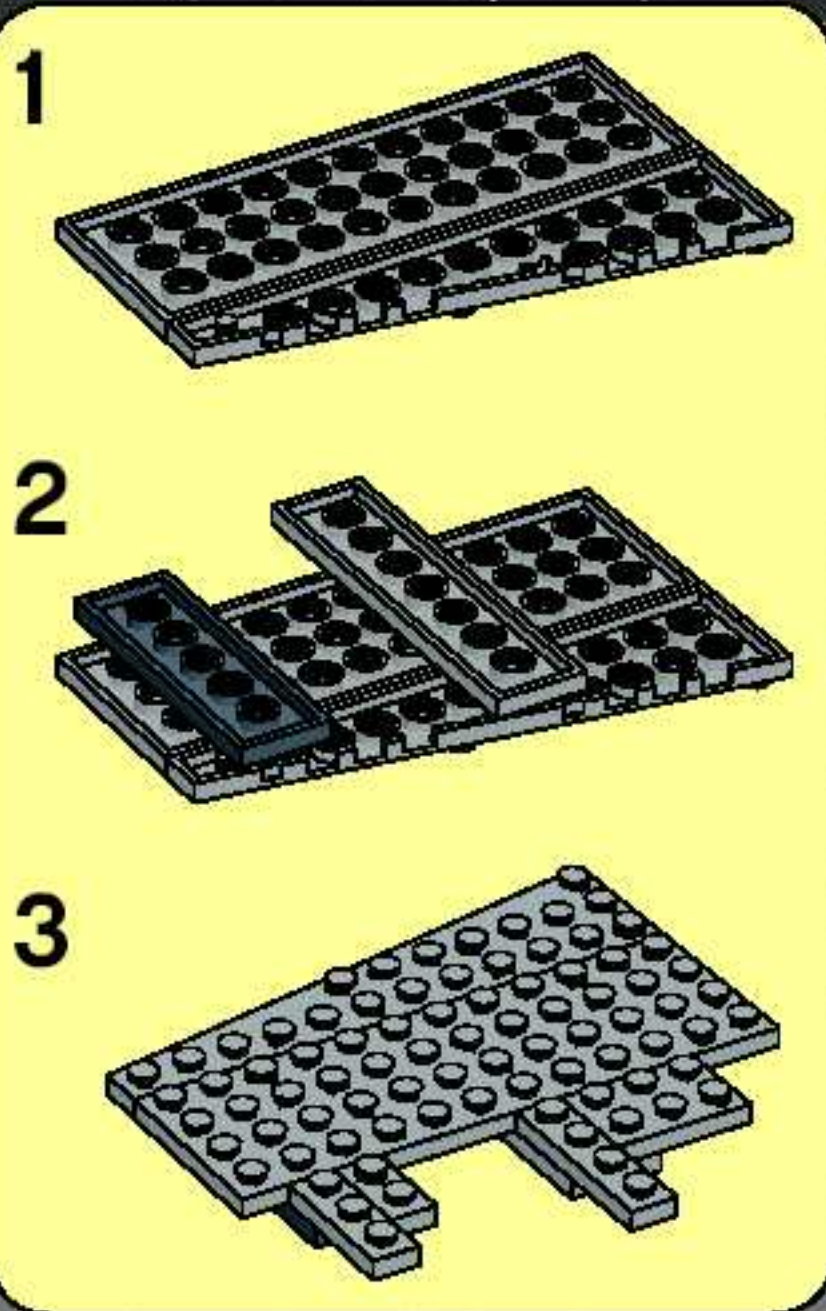
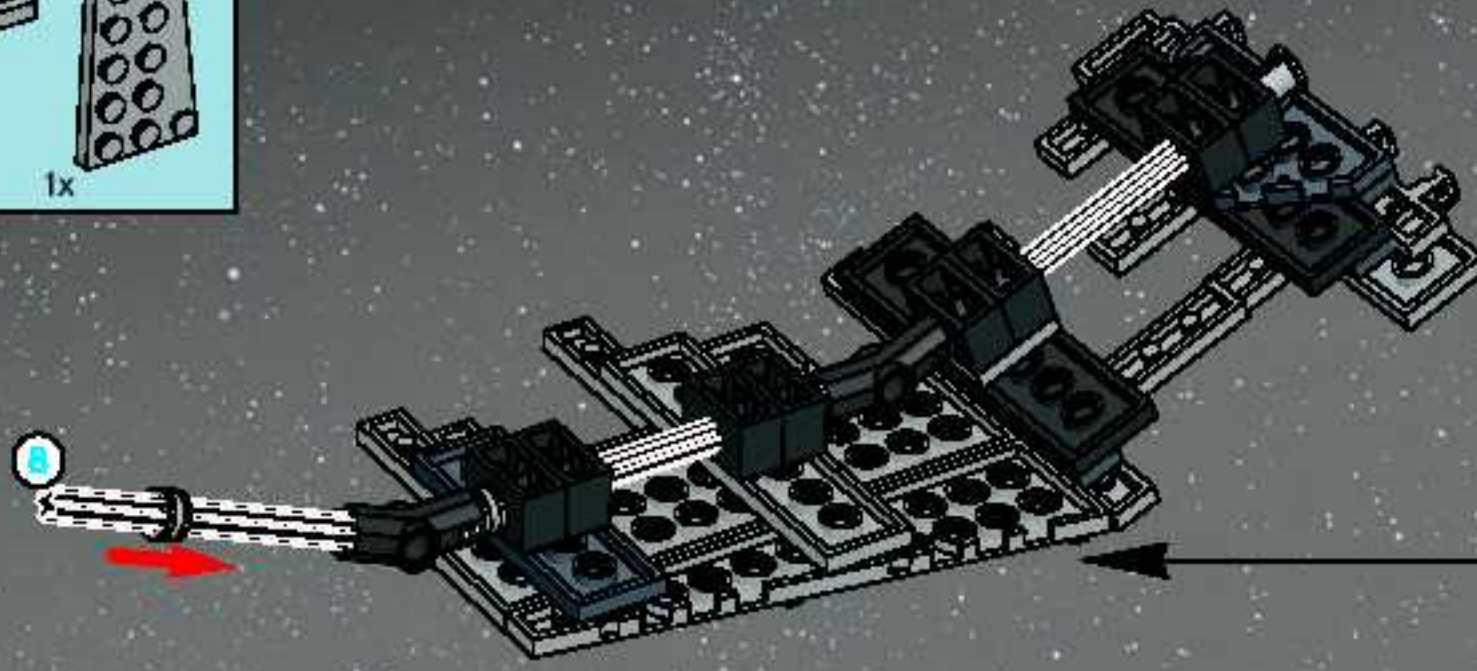

11

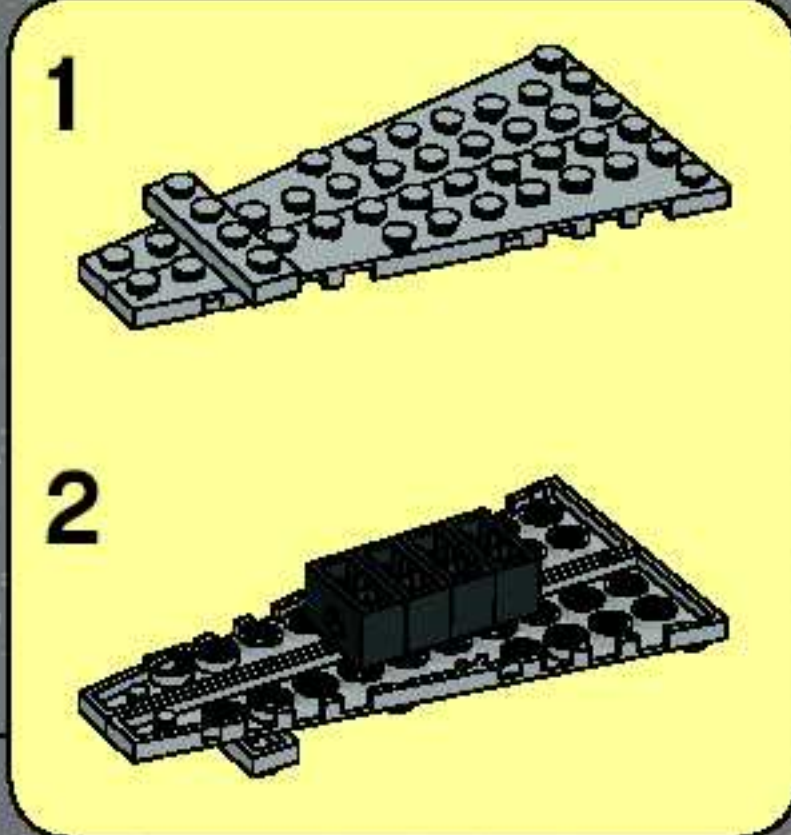
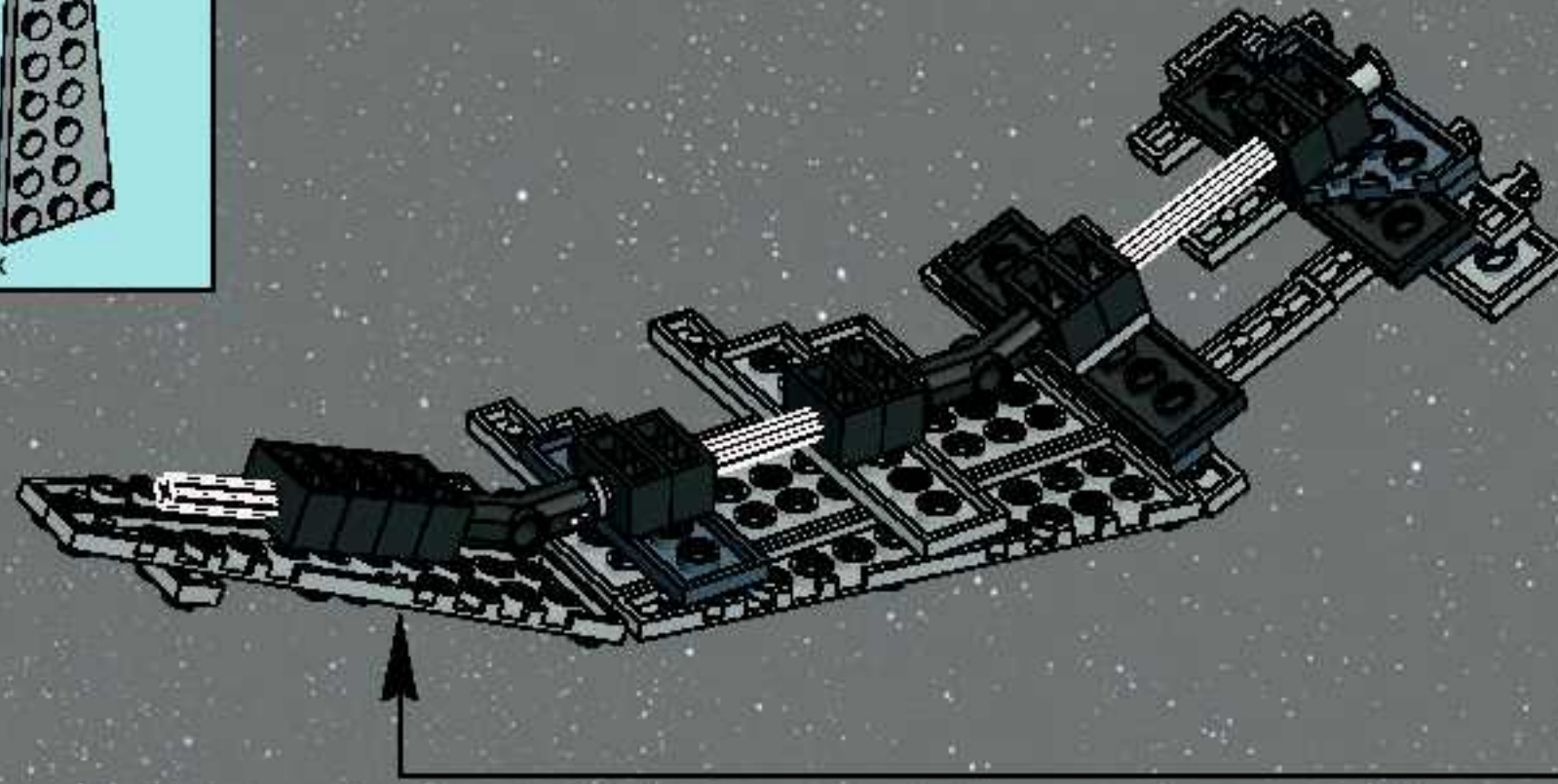

12

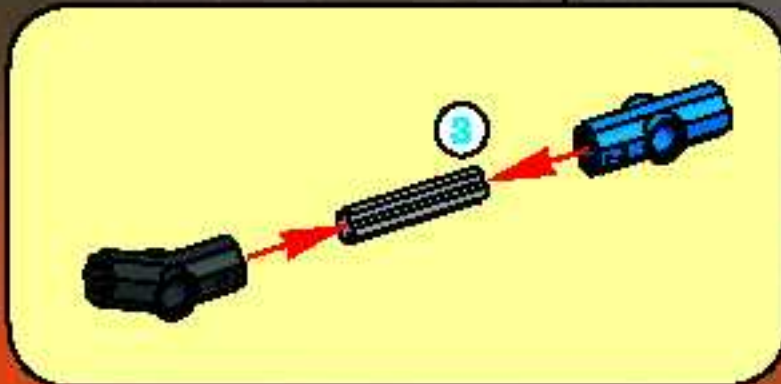
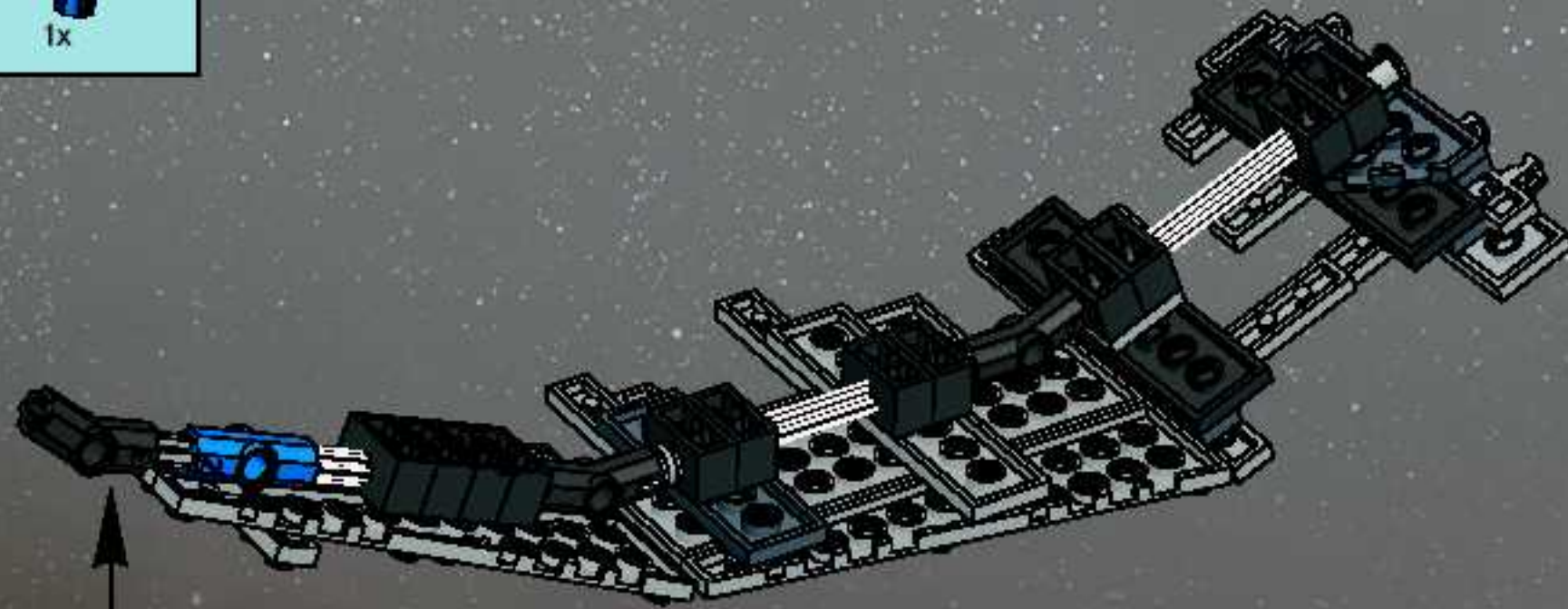



19

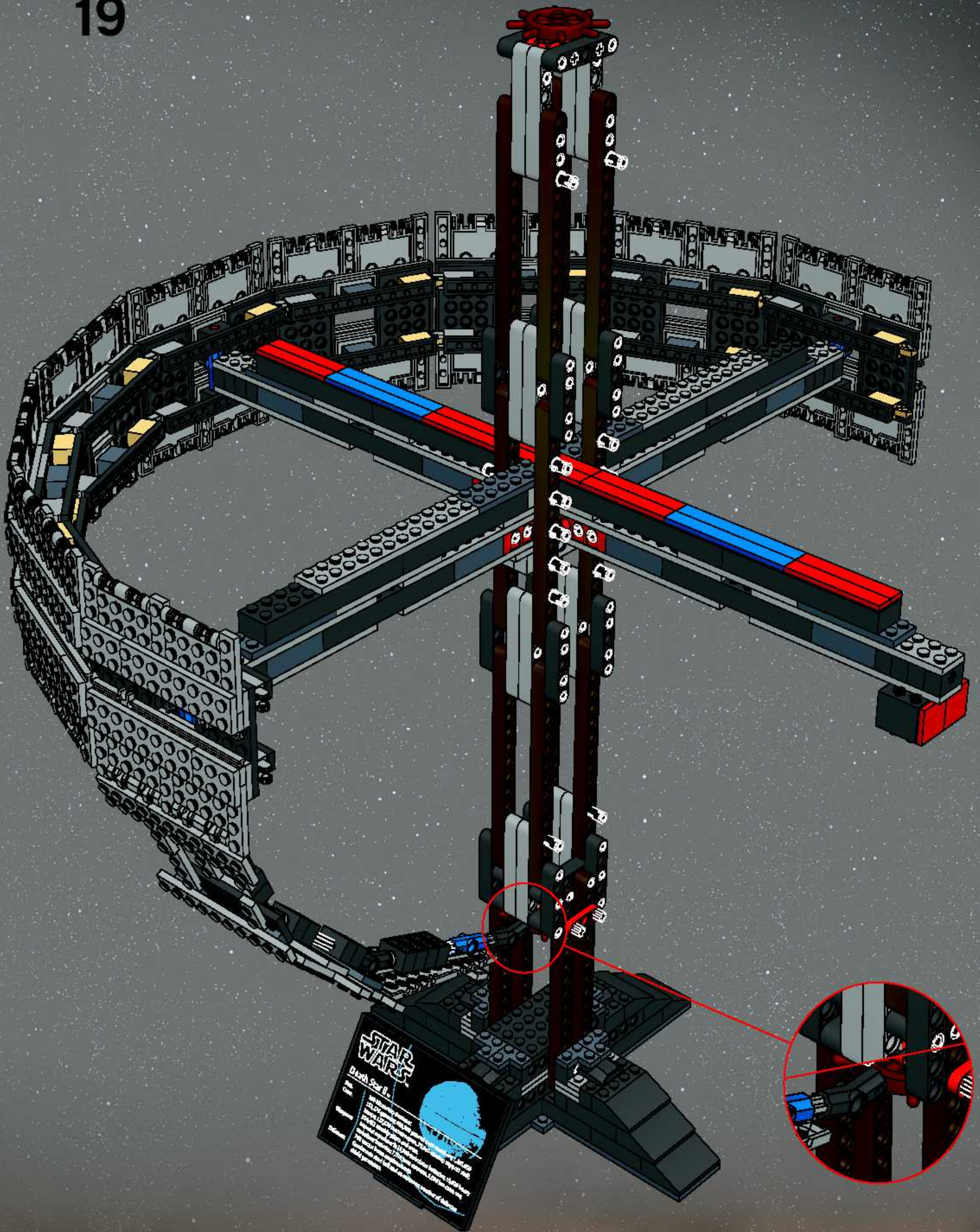



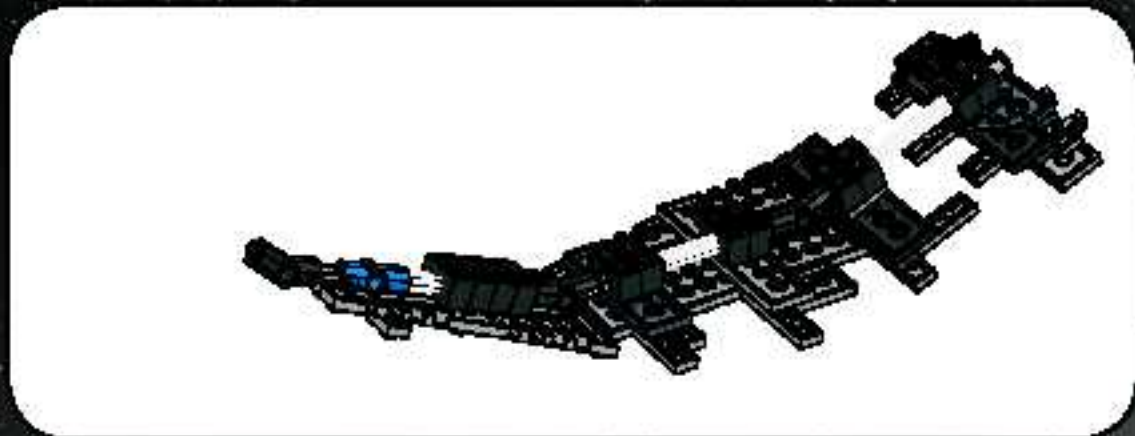

1



2

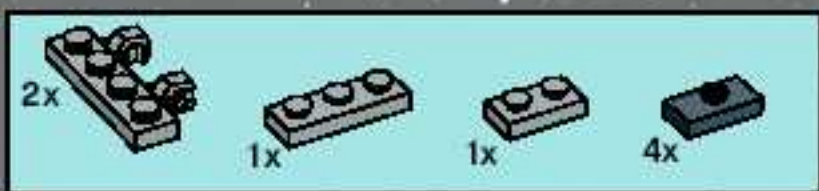

3



4

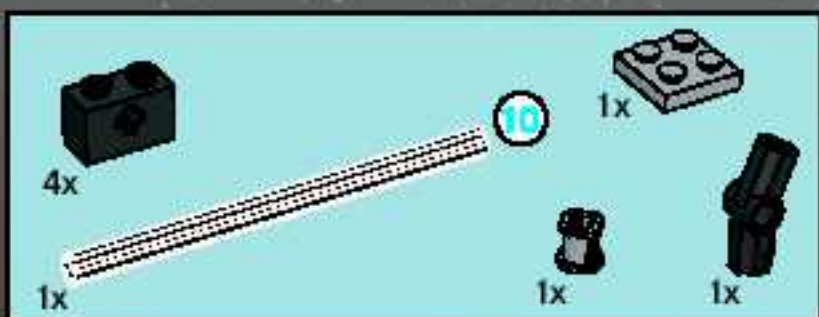
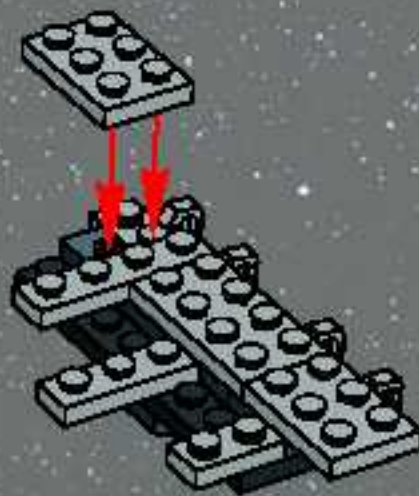

5

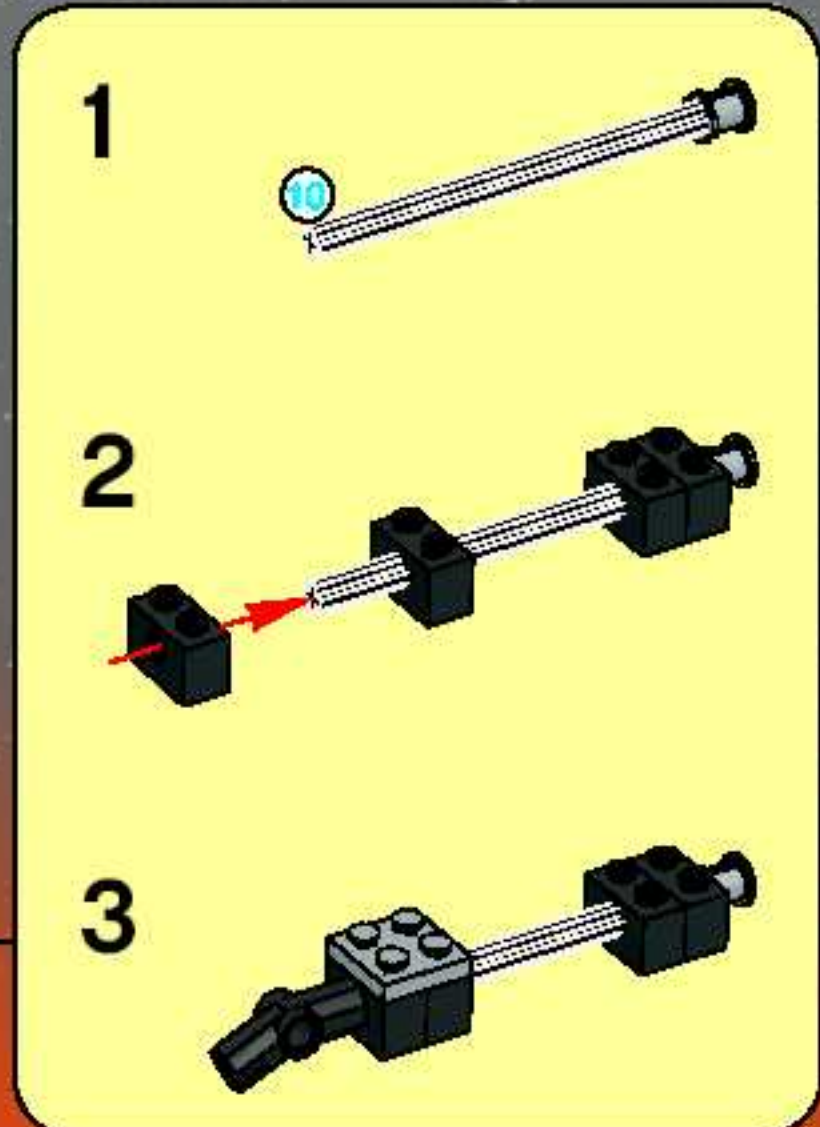
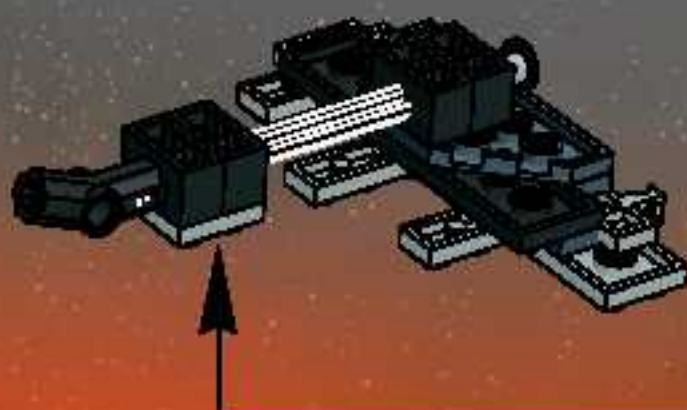



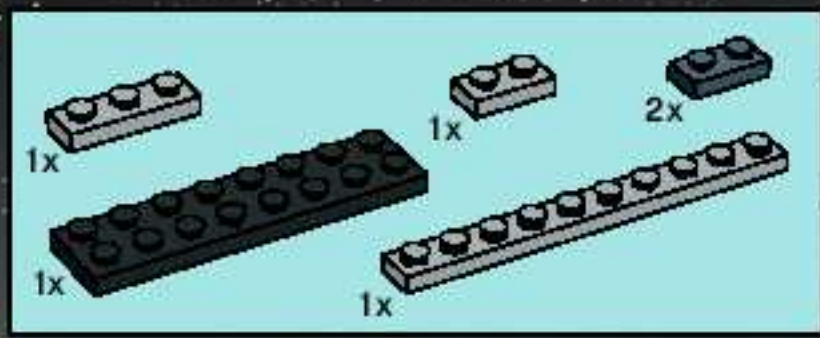

6

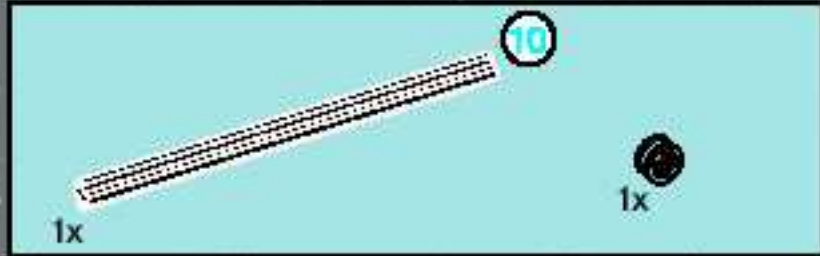
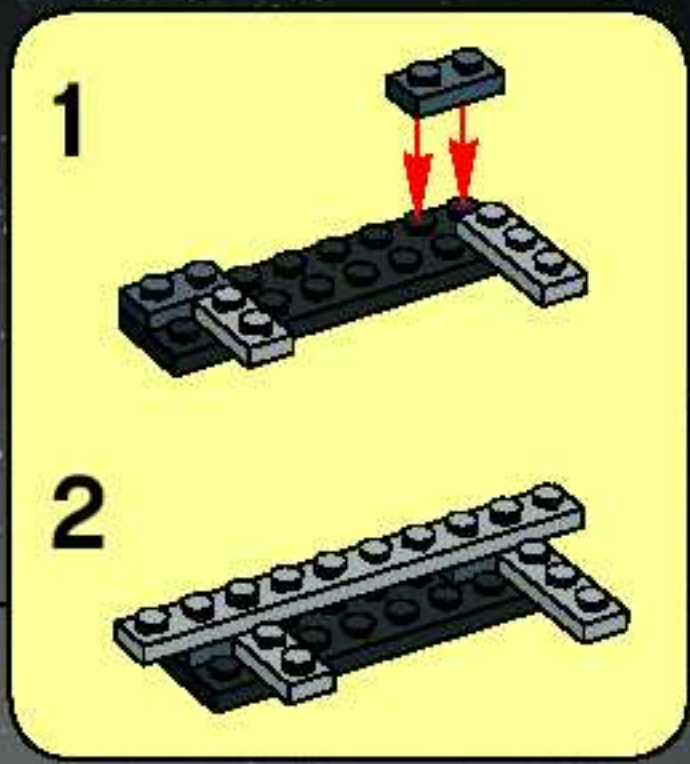
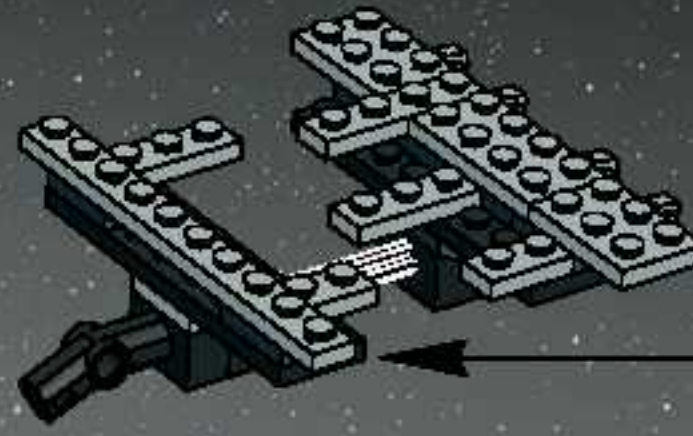

7

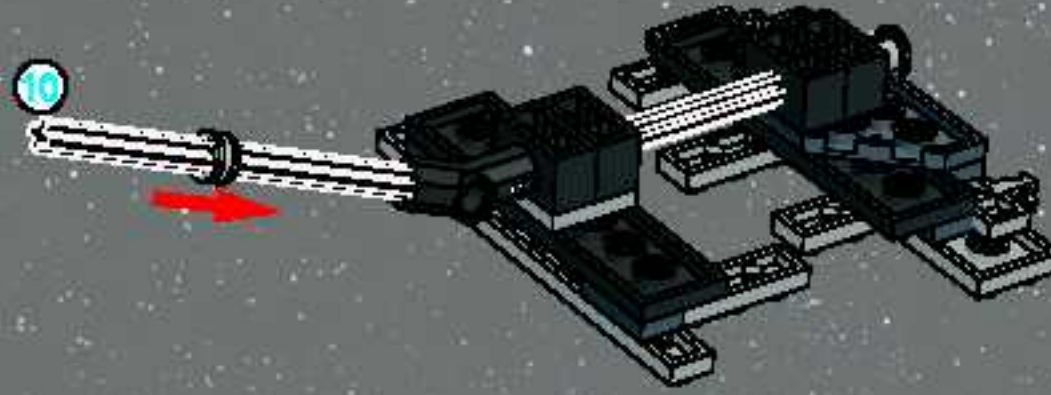

8

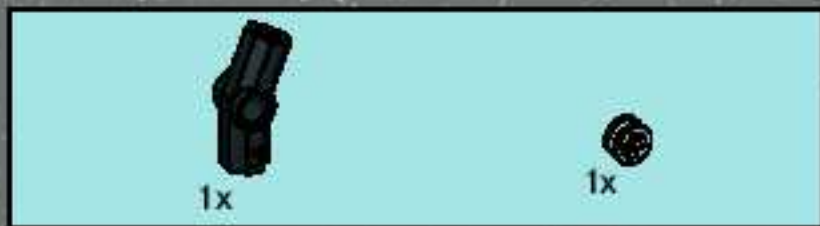

9





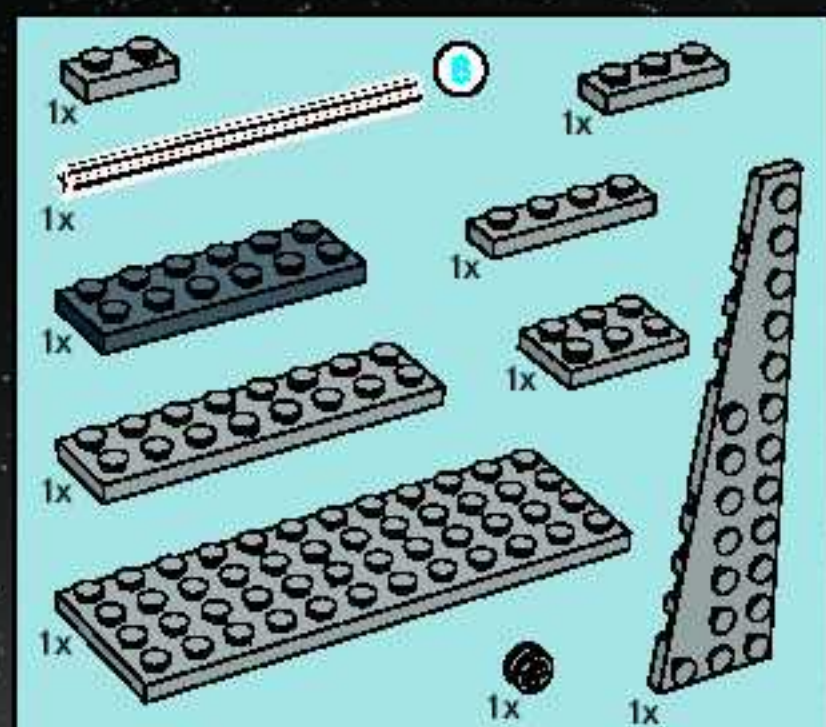

# 10

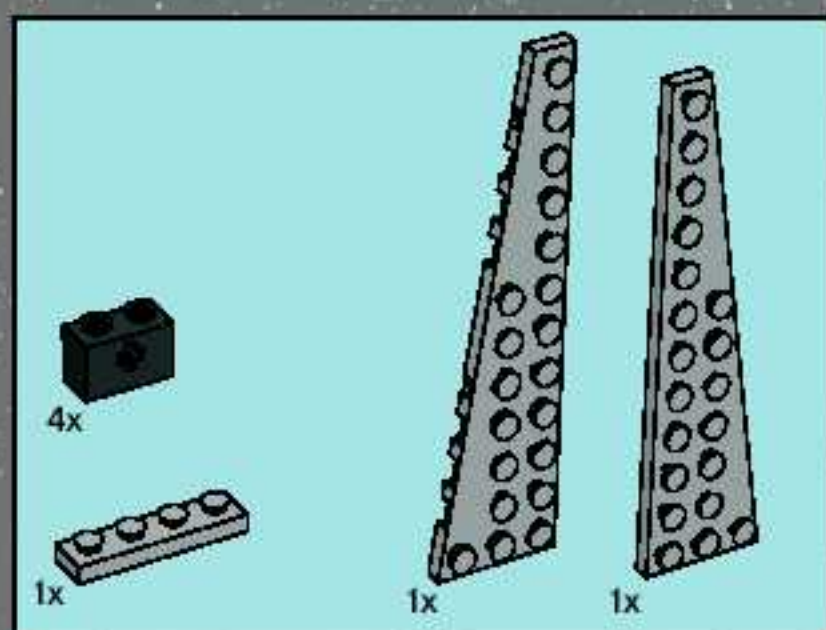
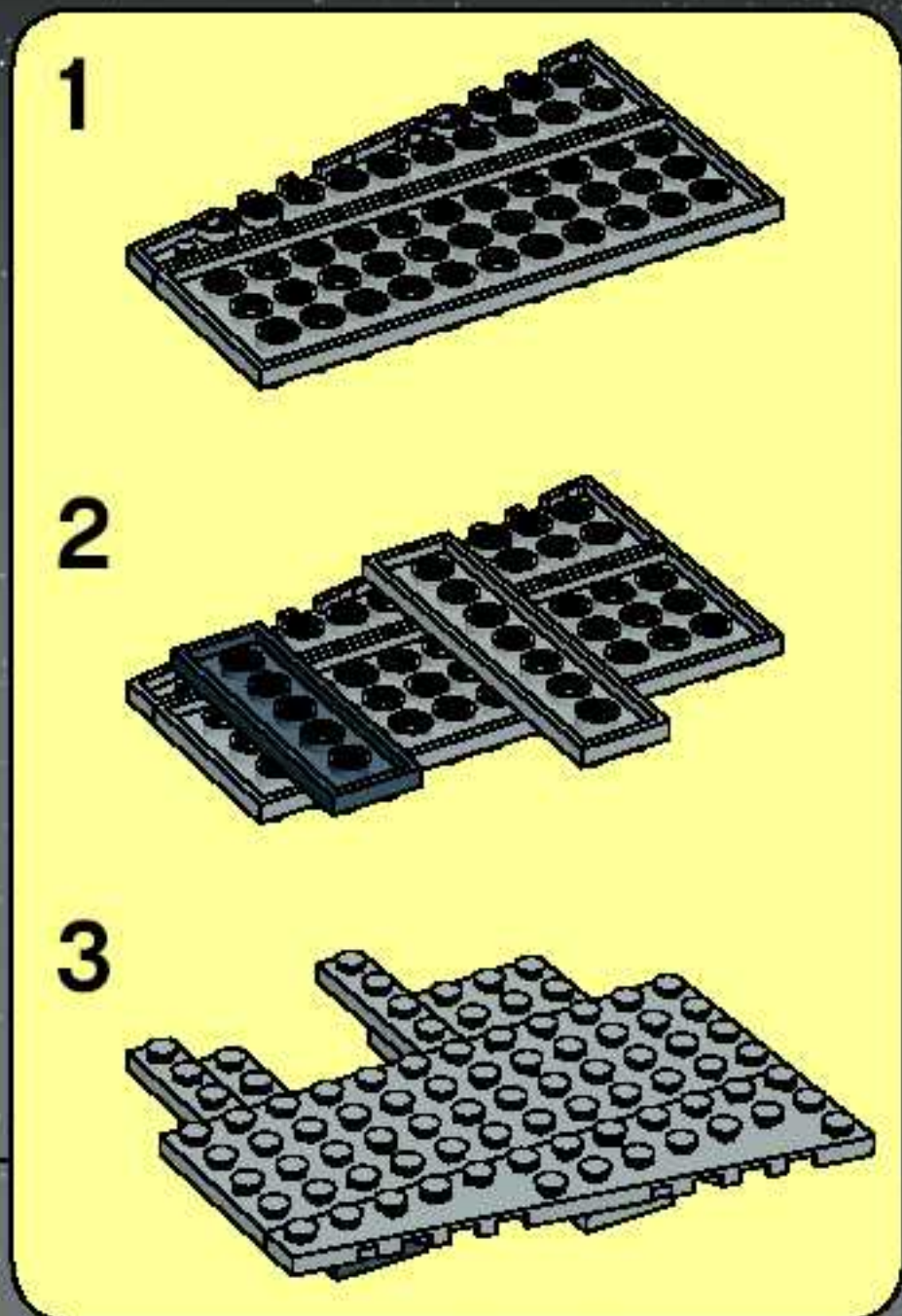
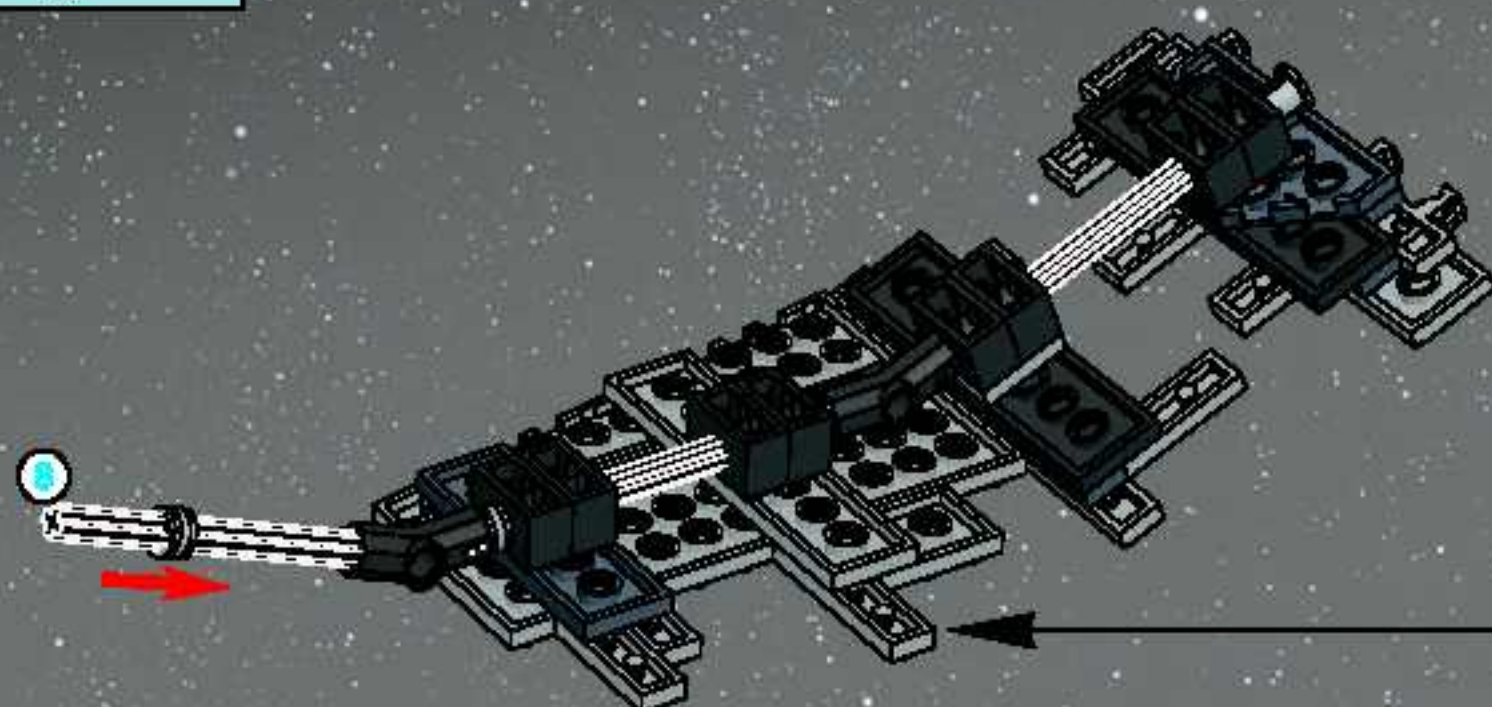

# 11

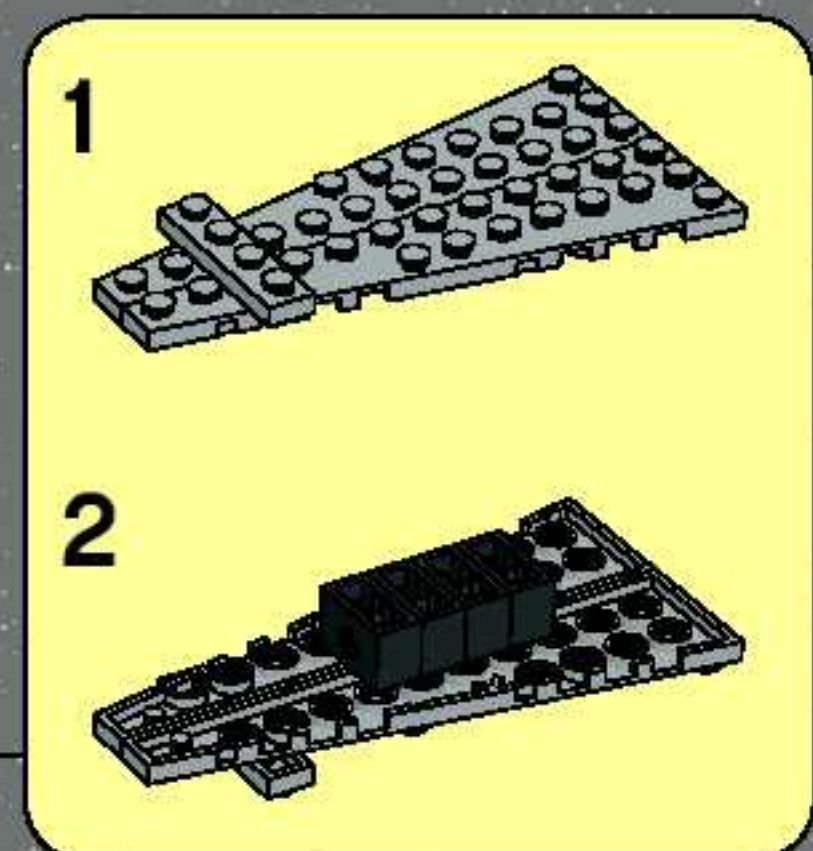
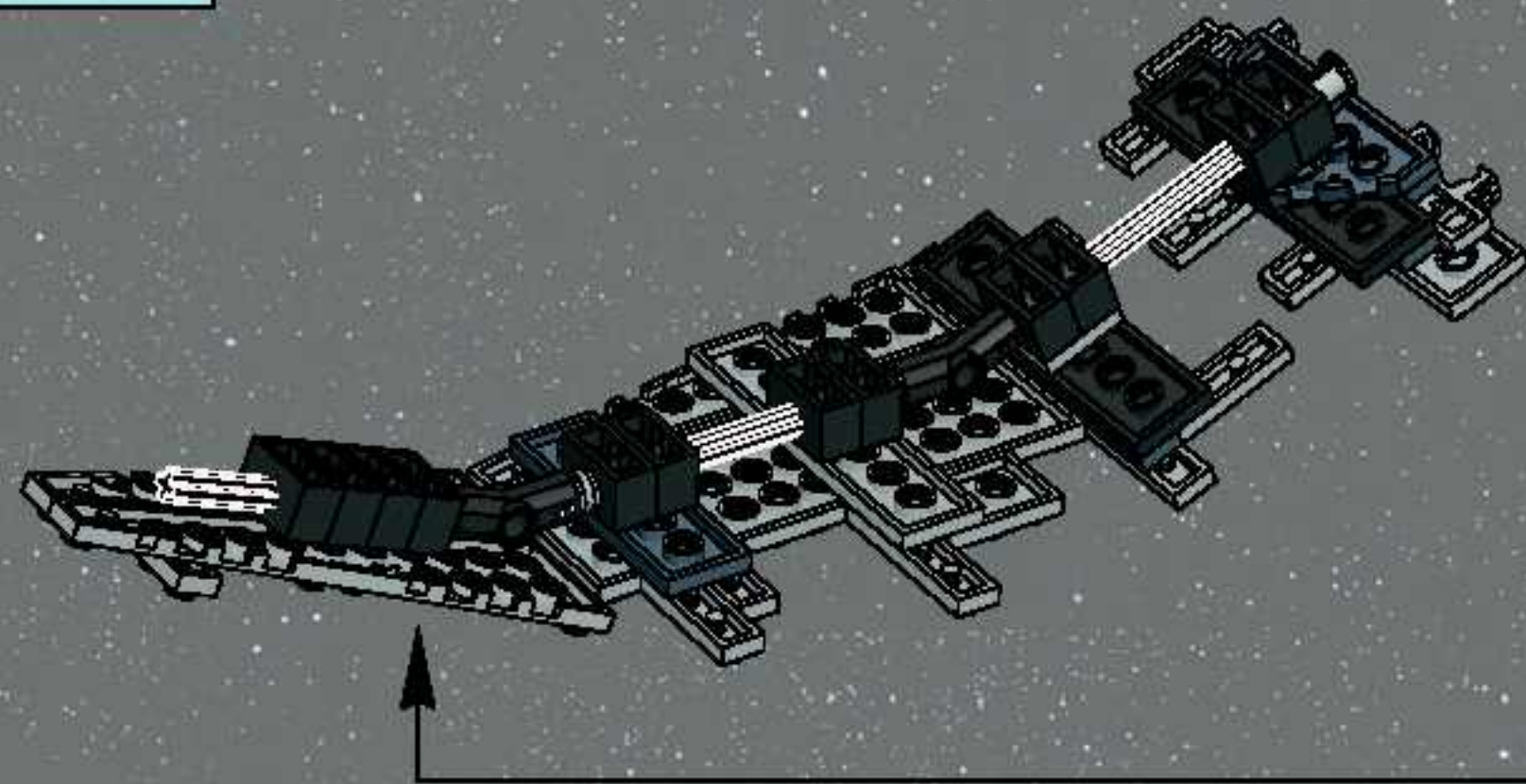

# 12

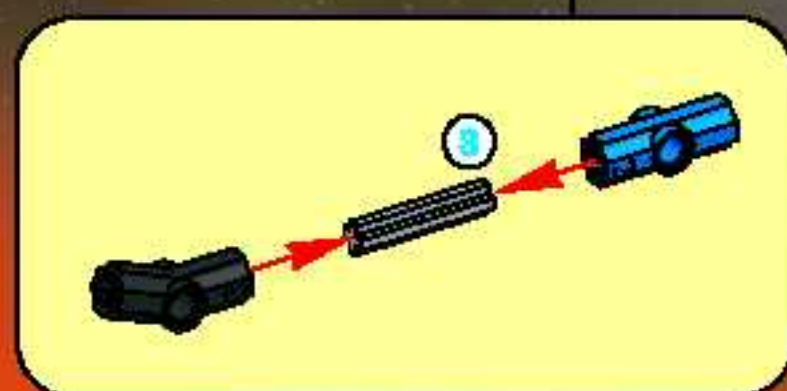
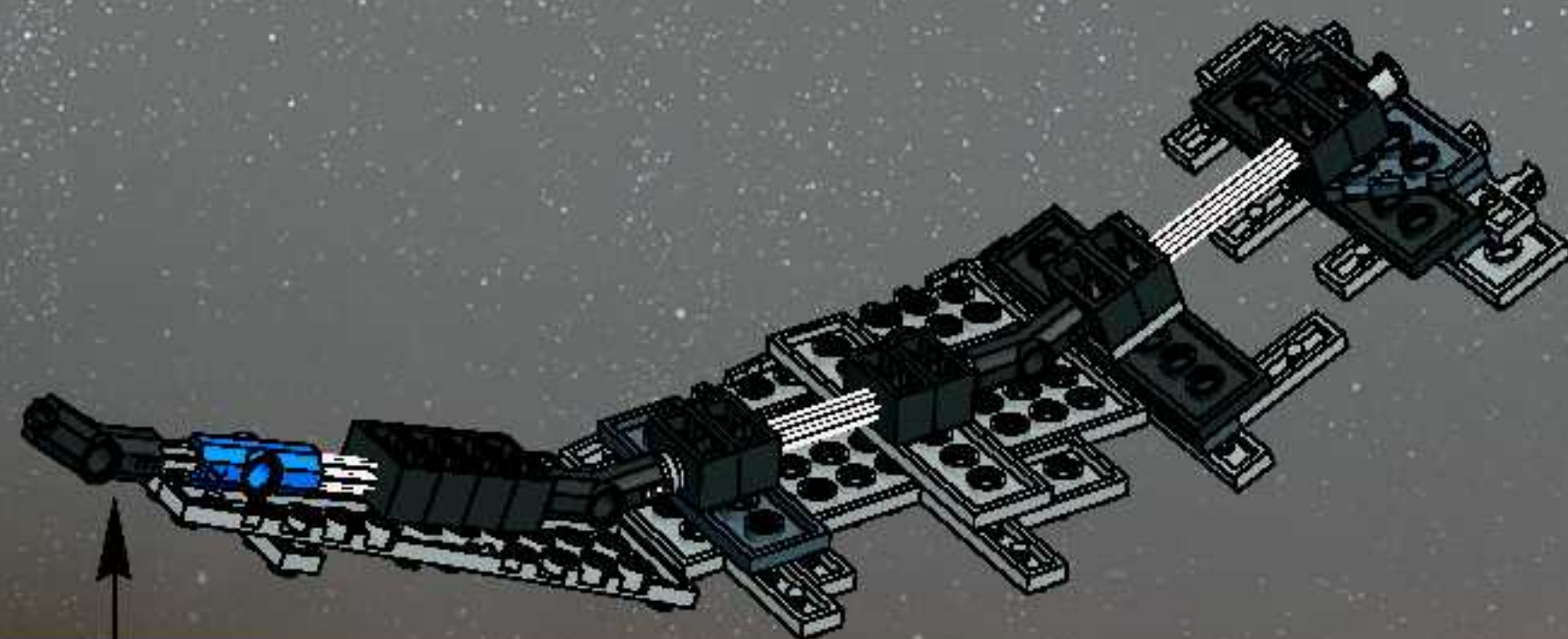



20

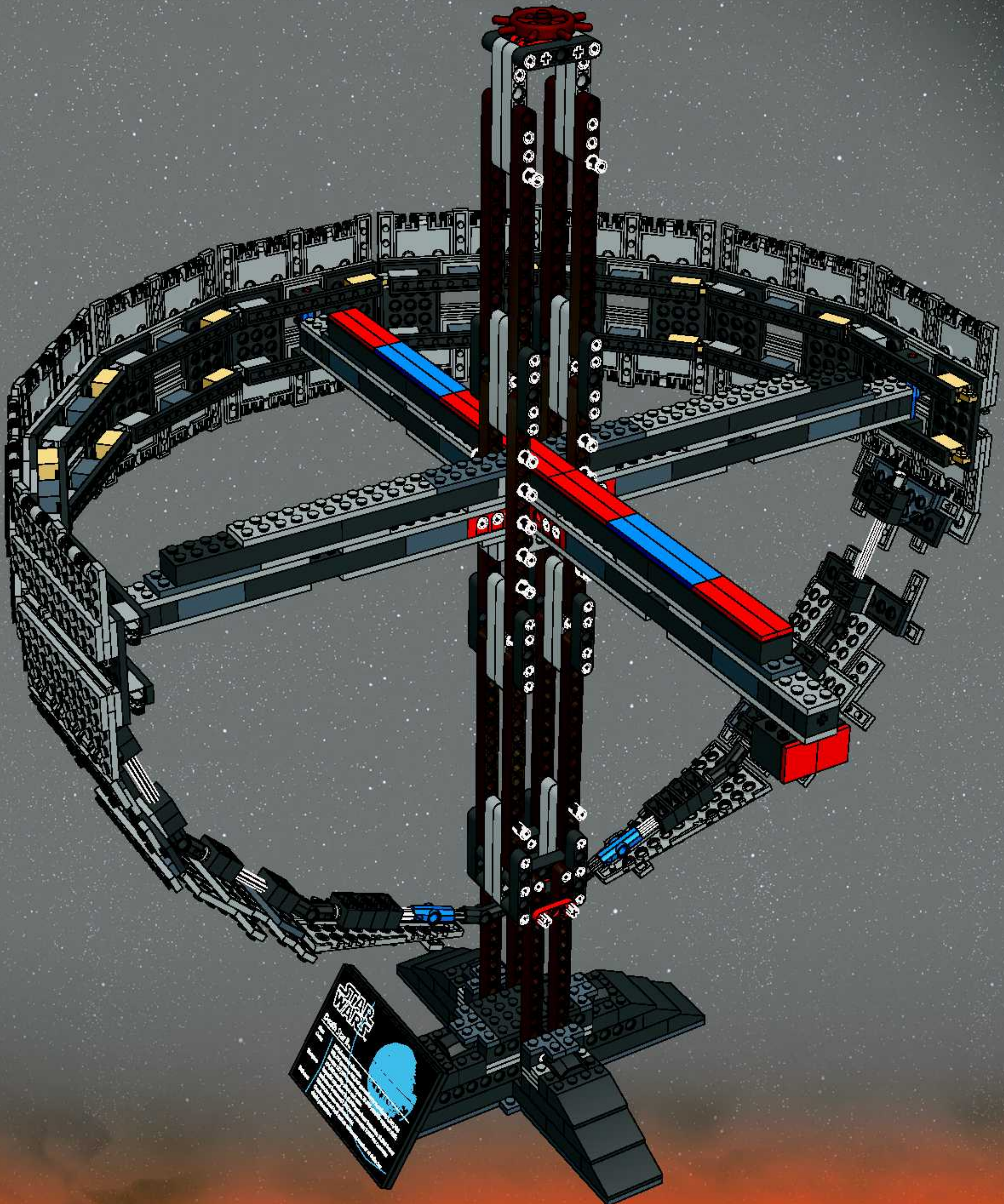



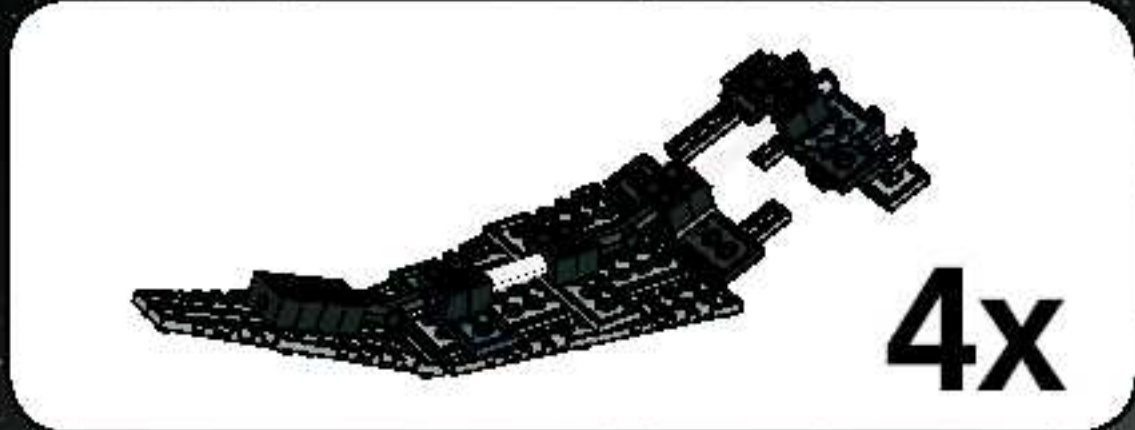

1



2



3



4

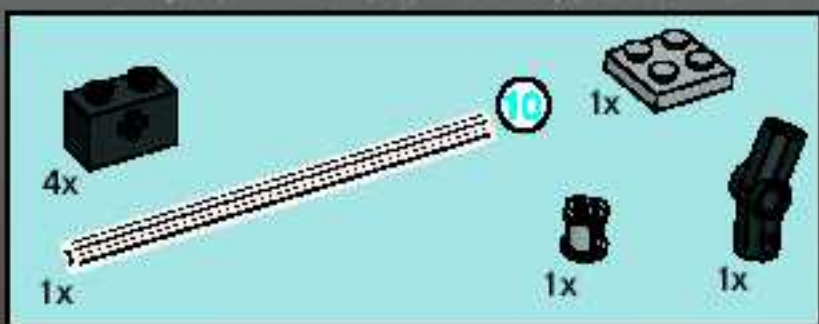
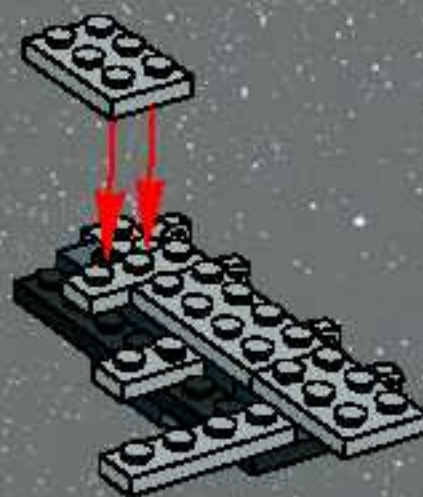

5

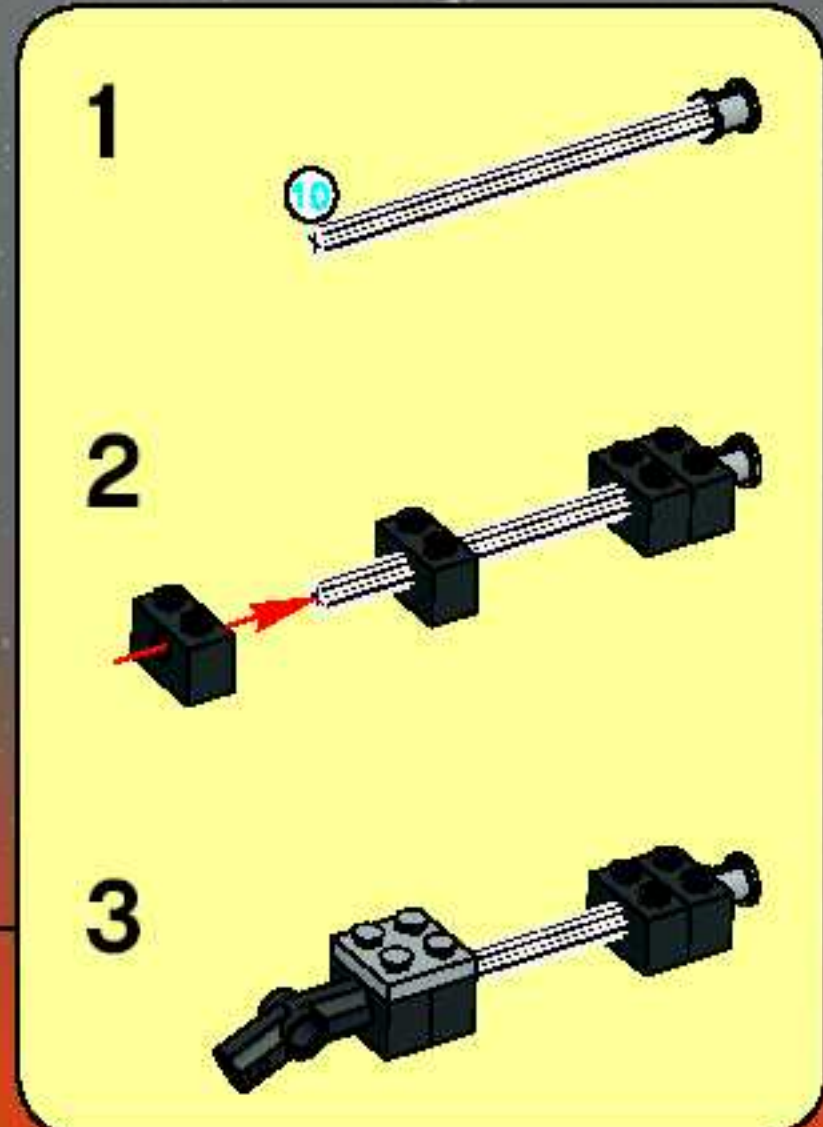
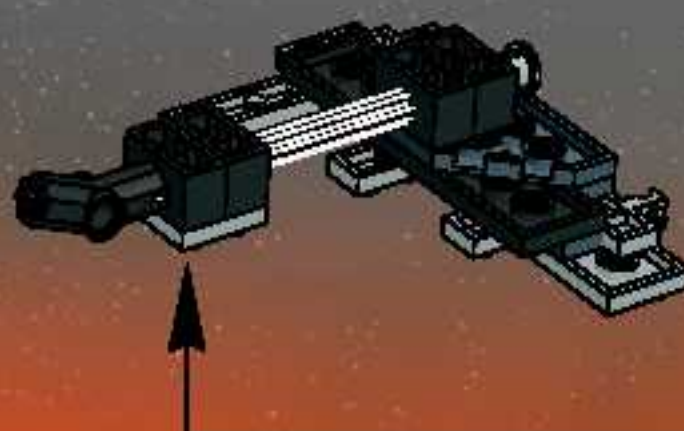





6

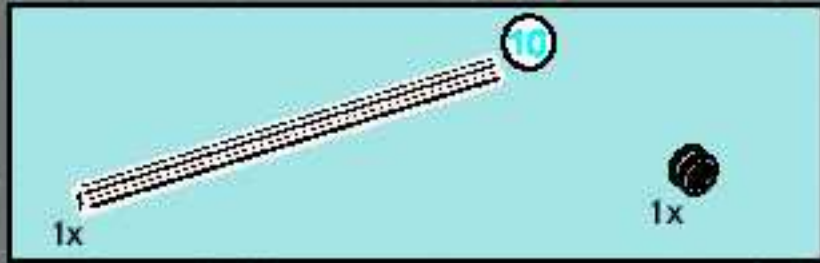

7

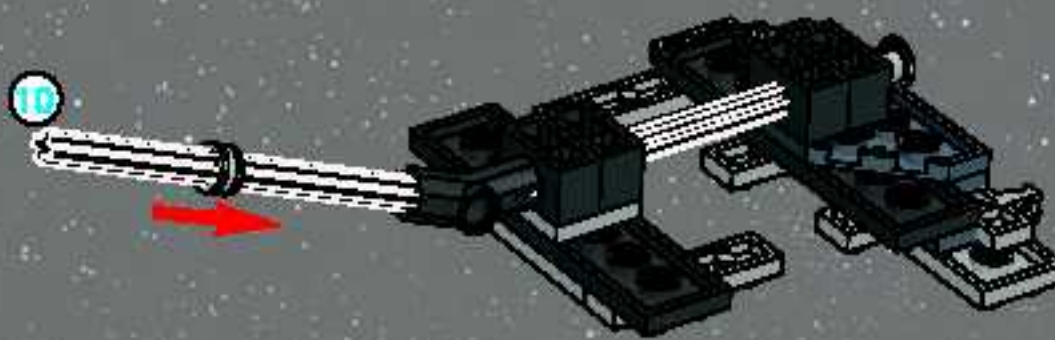

8



9





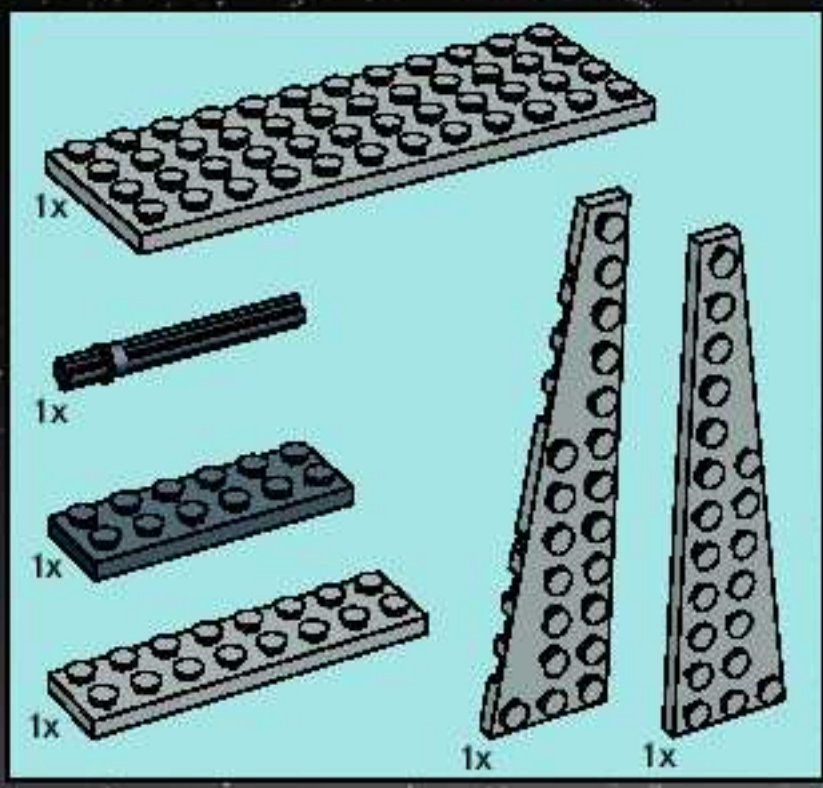

10

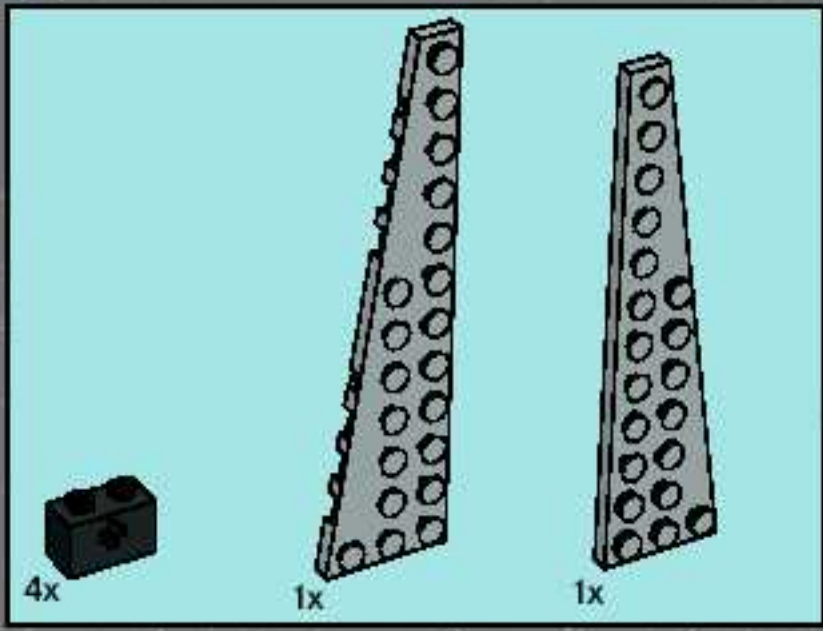
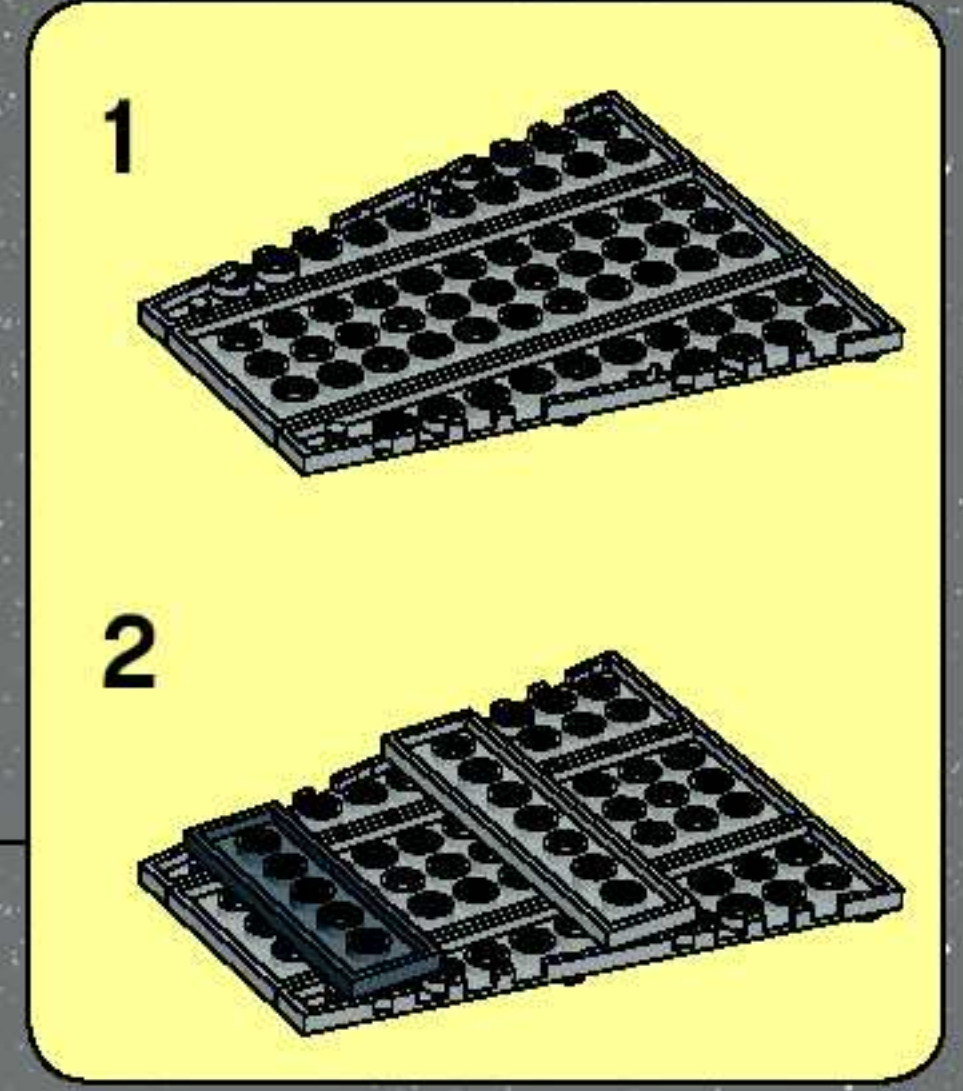
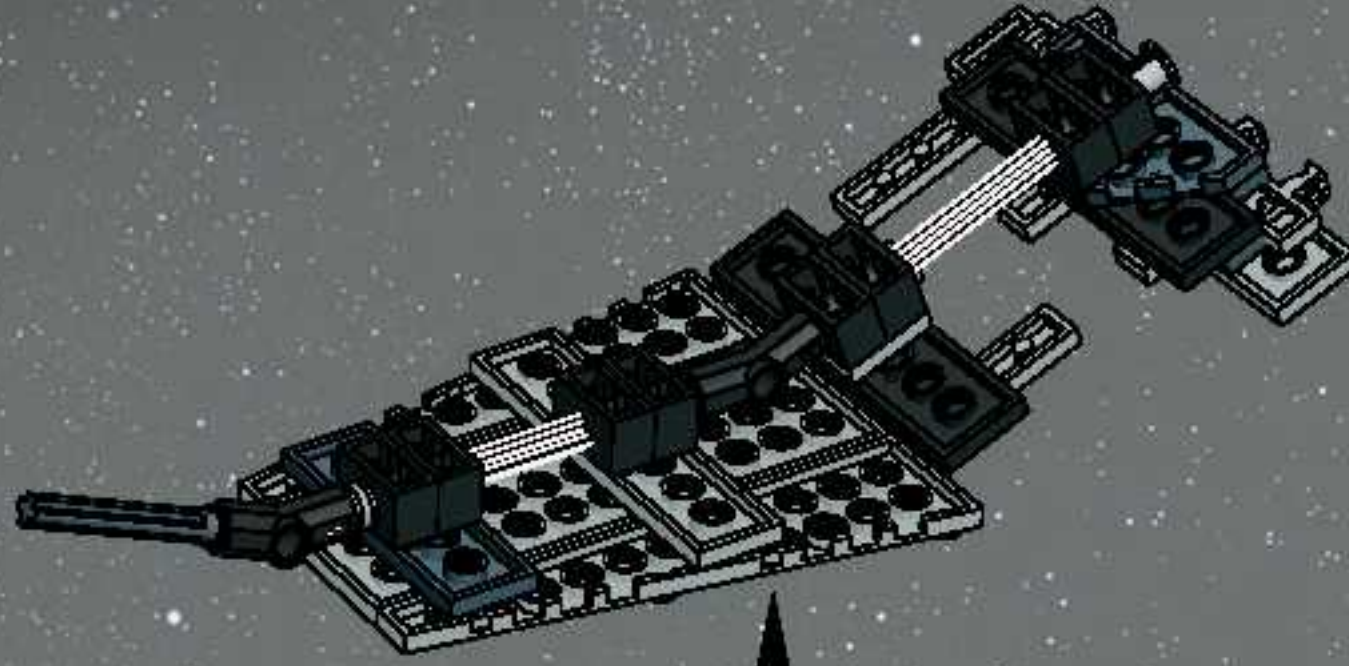

11

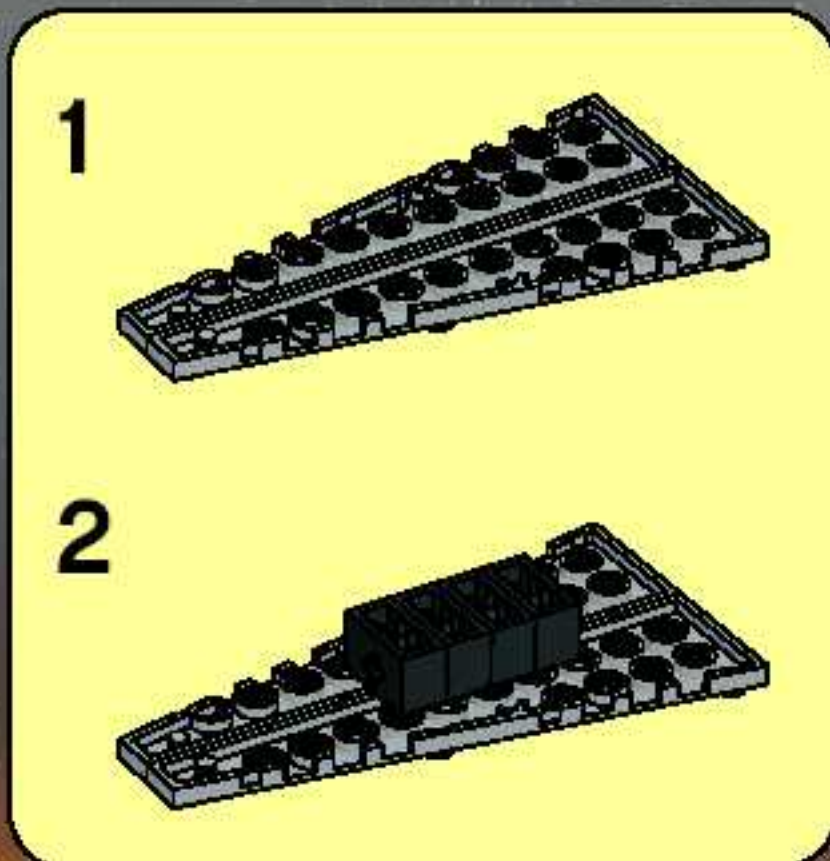
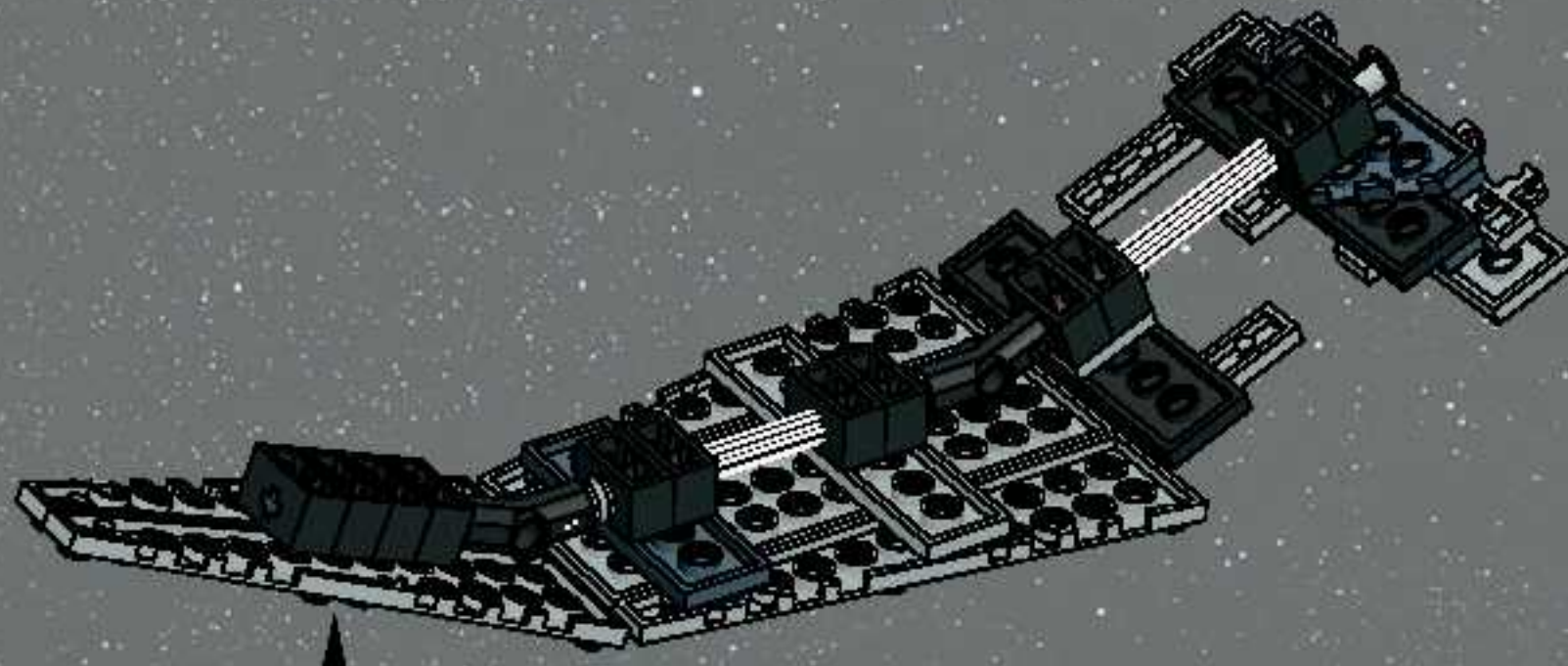

4x



21

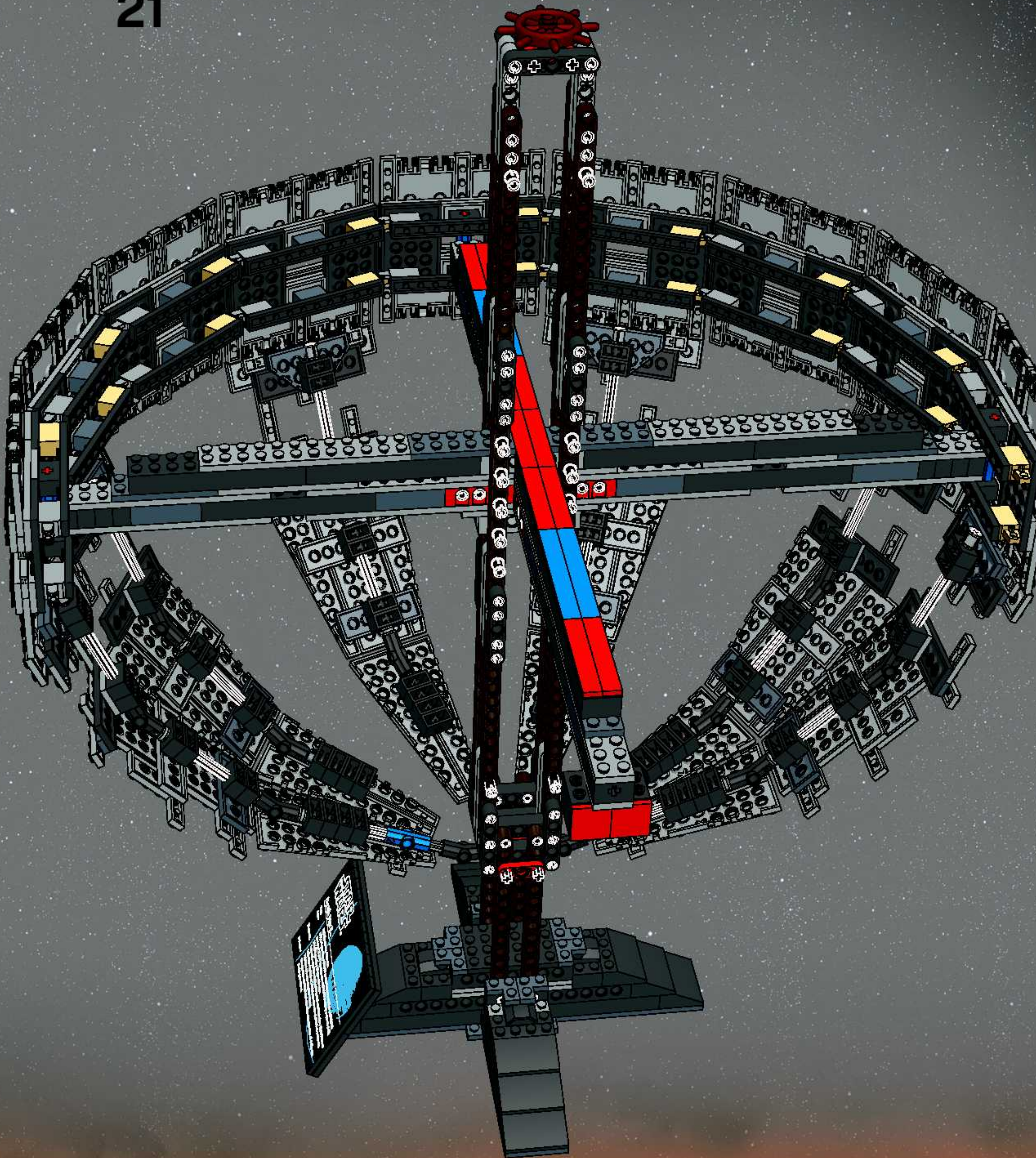



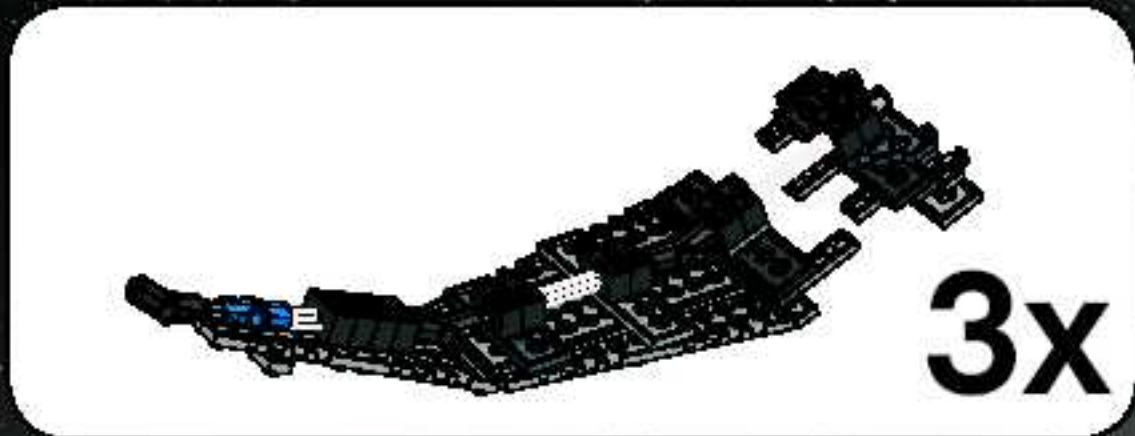

1



2



3

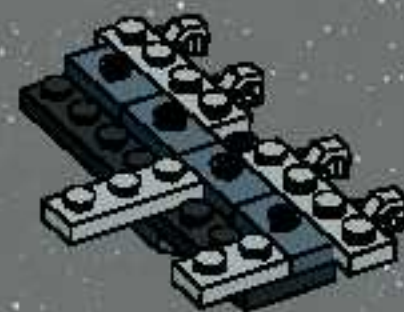

4

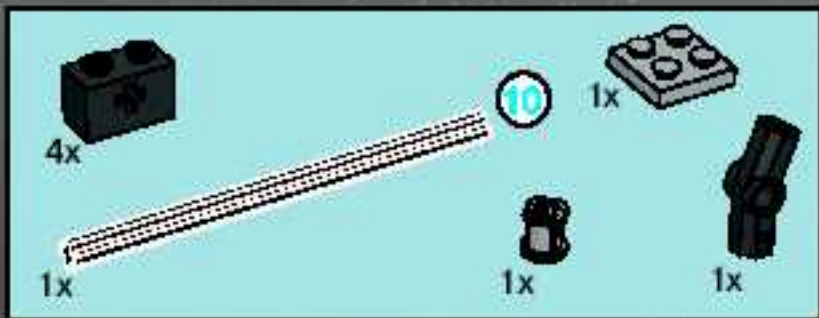
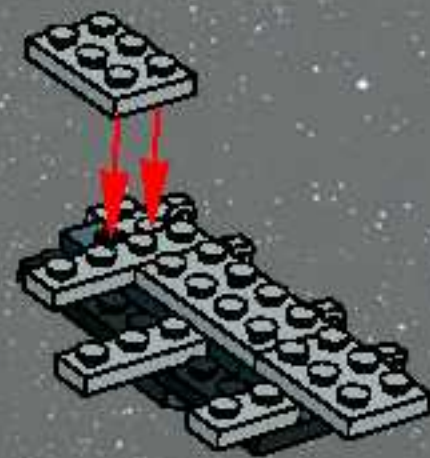

5

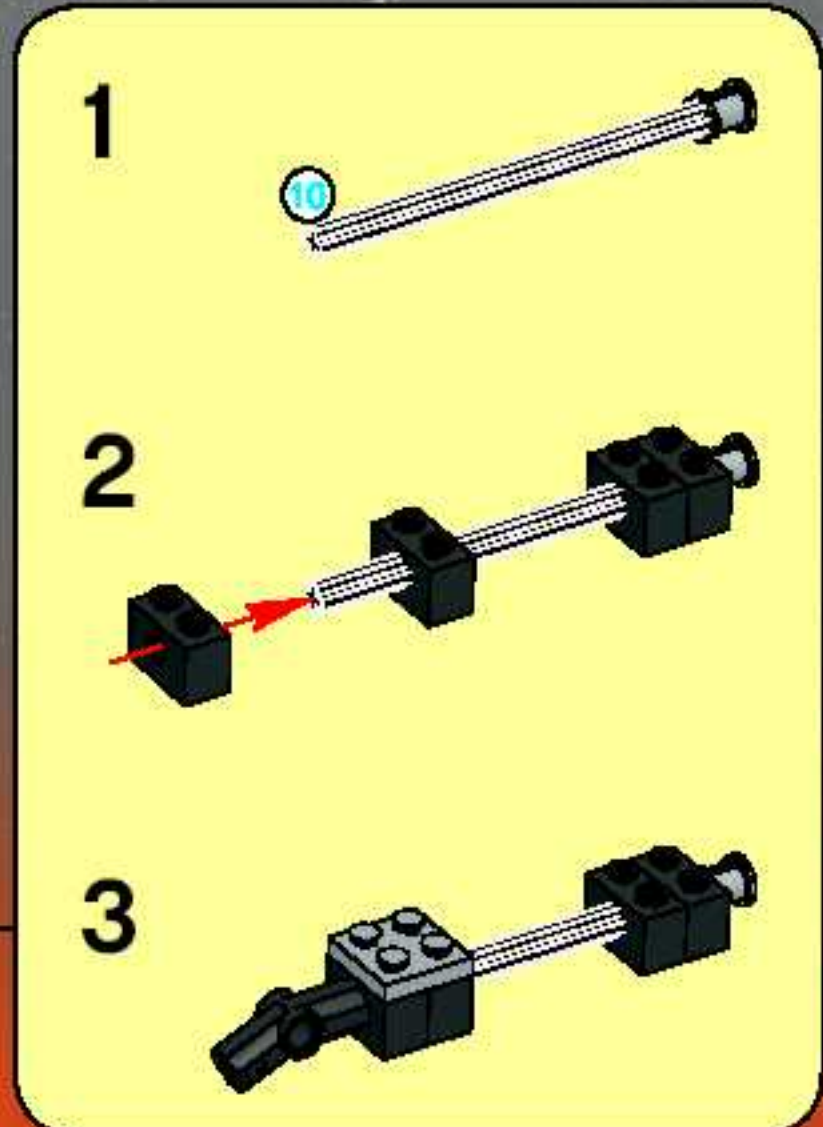
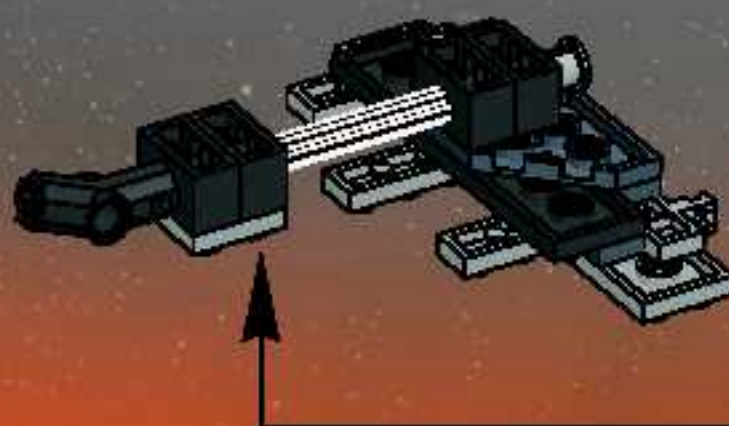



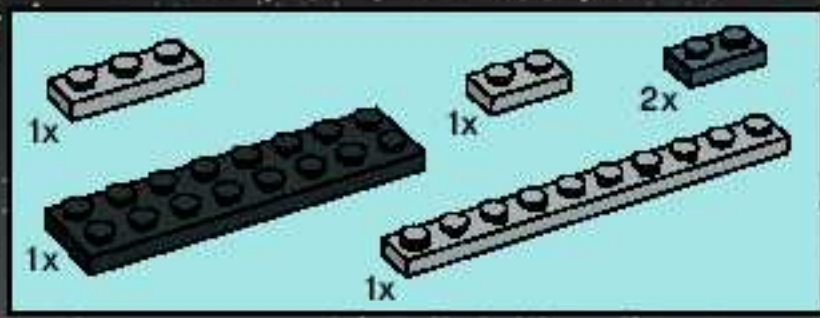

6

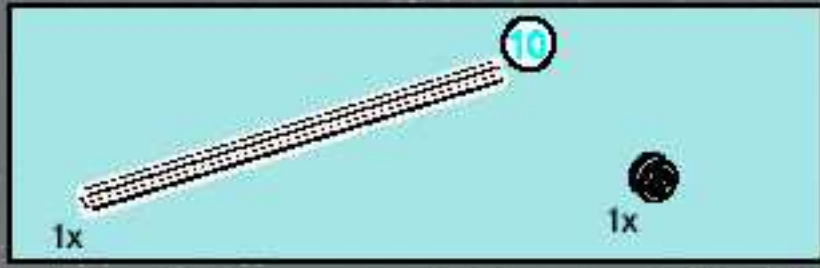
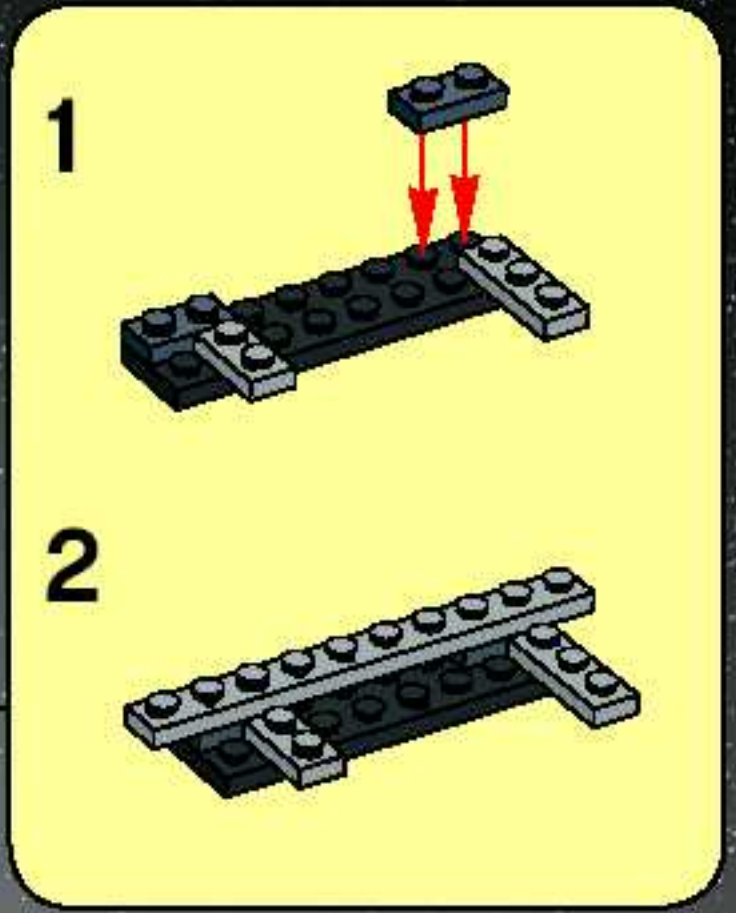
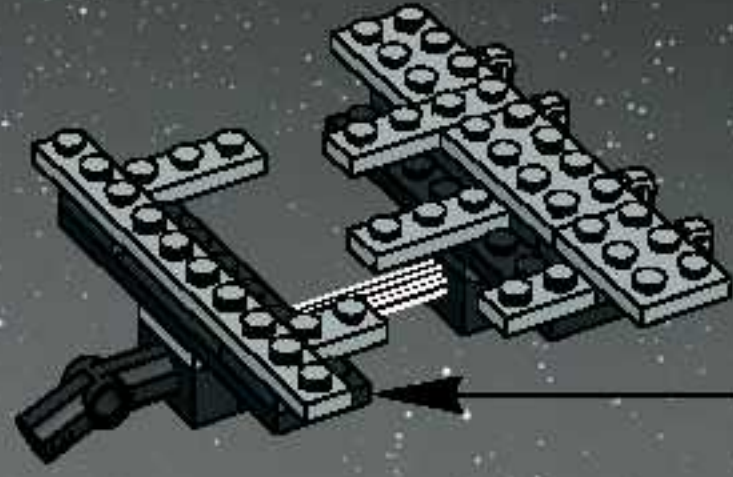

7

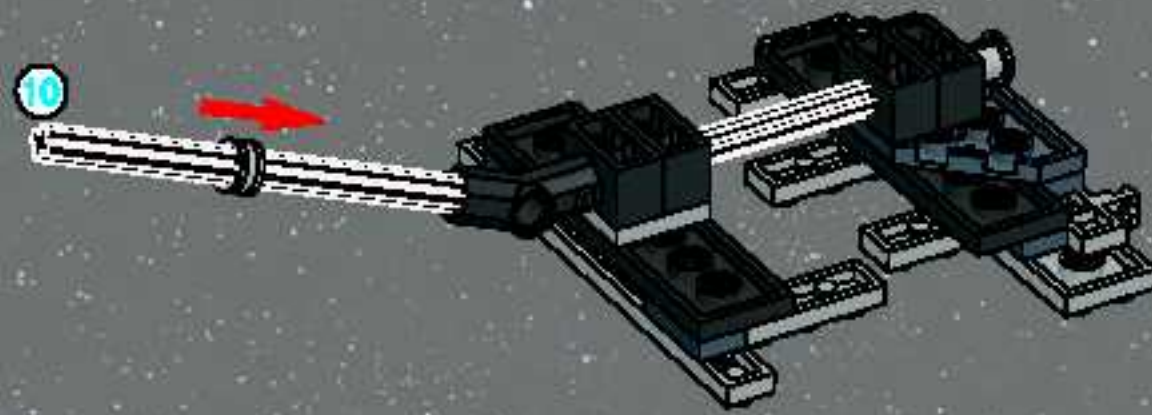

8

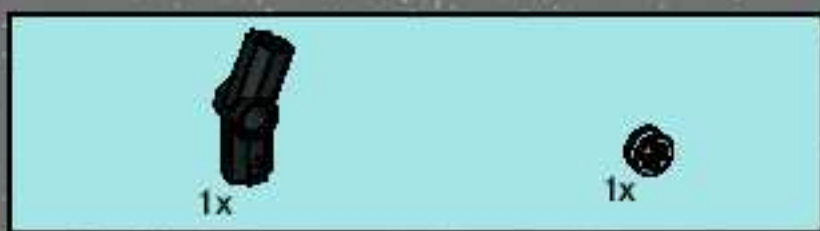
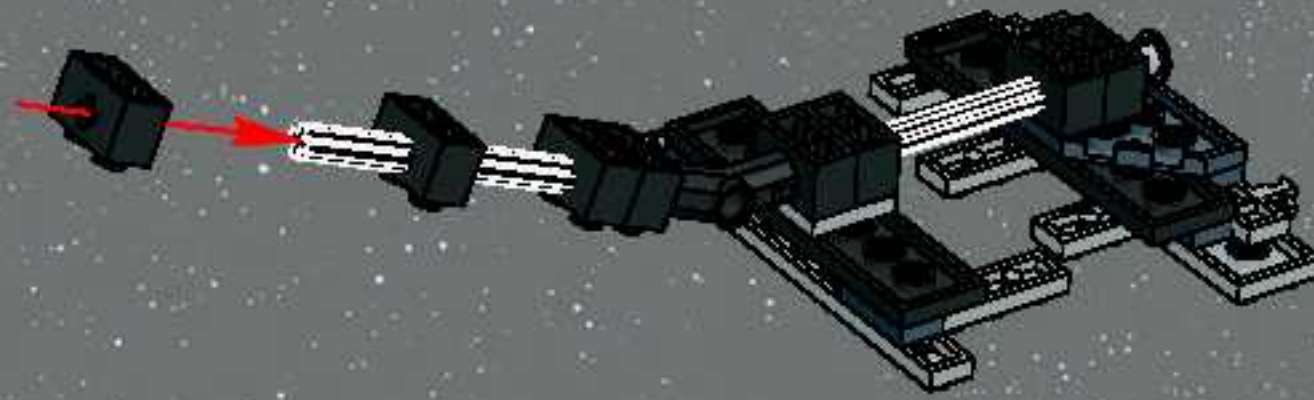

9





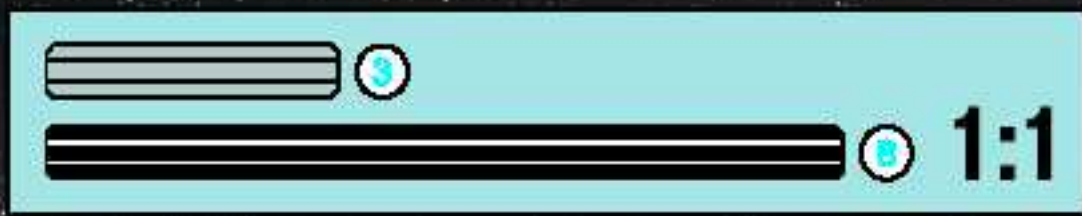
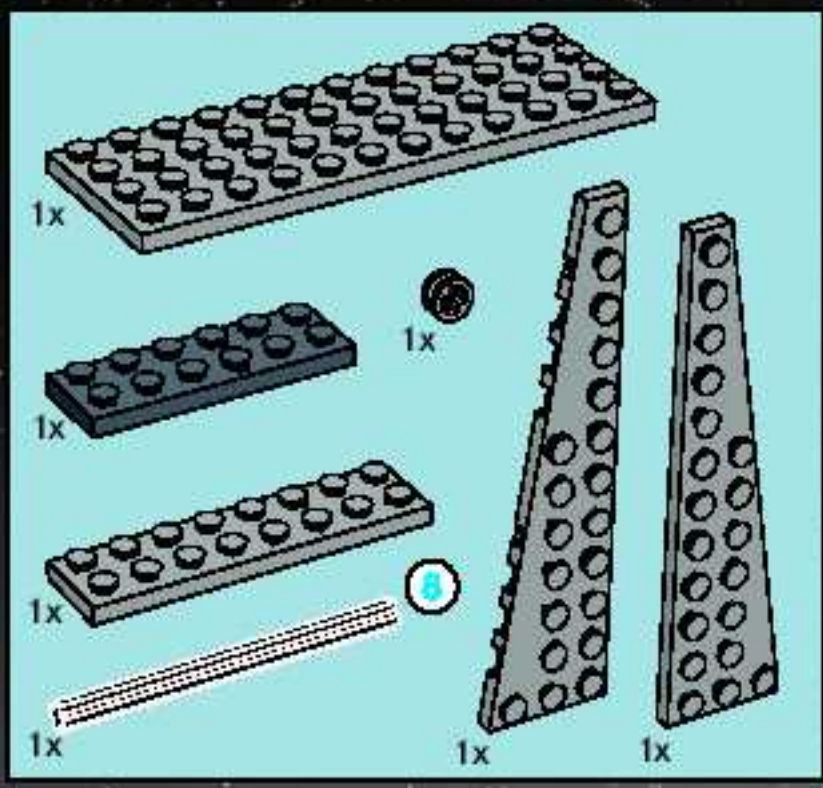

10

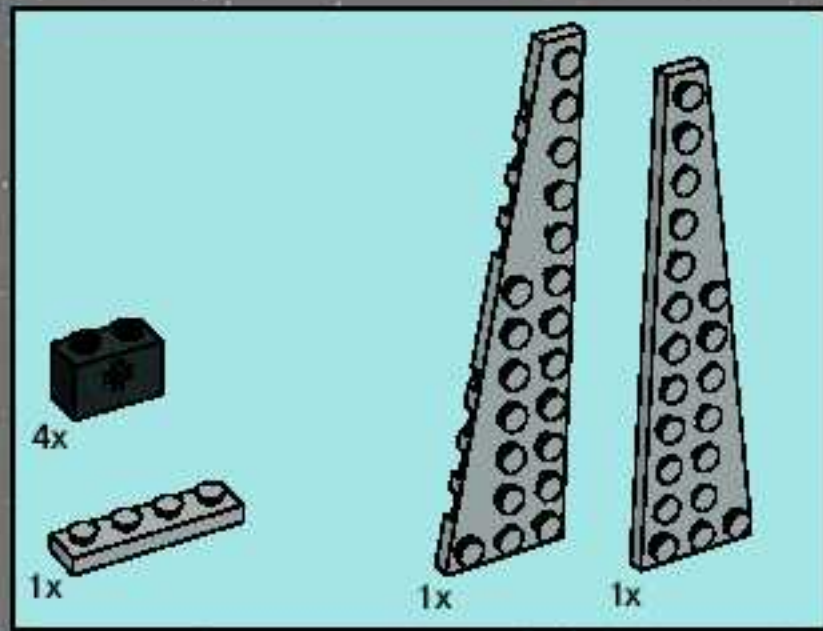
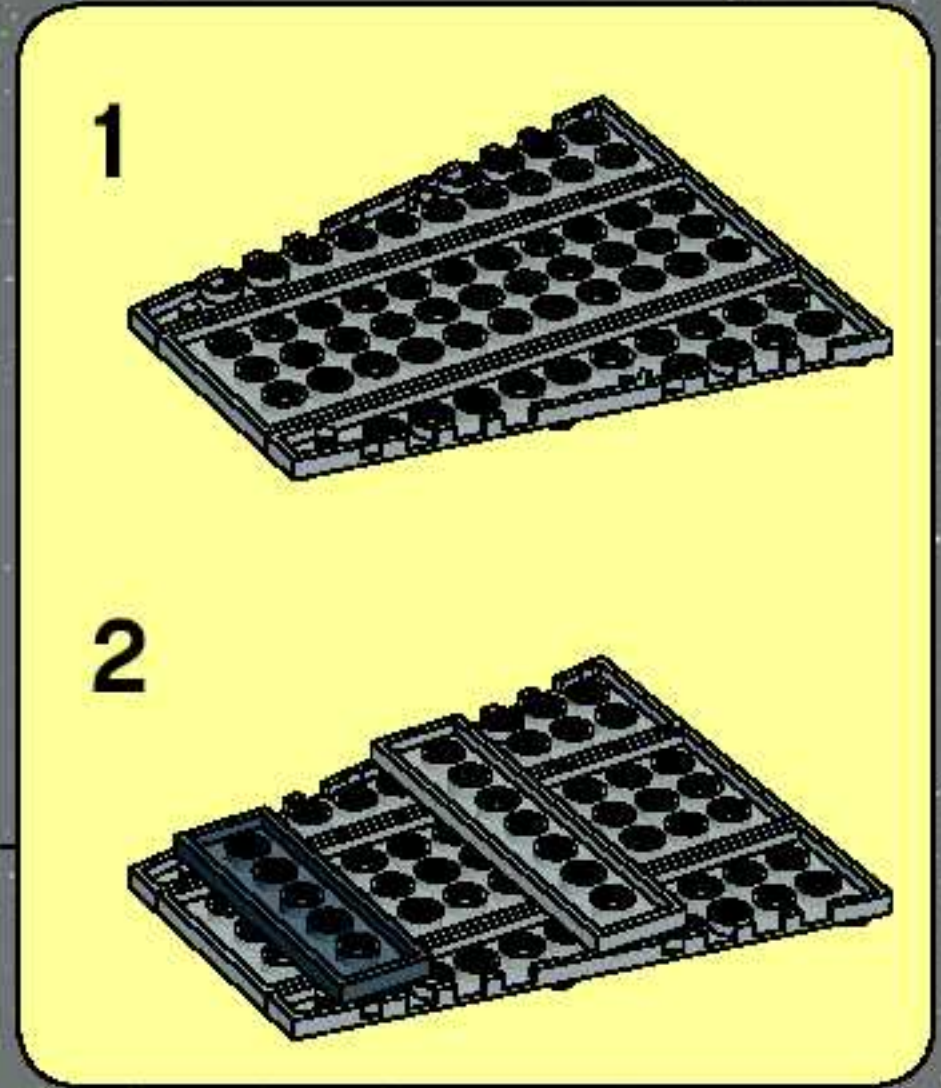
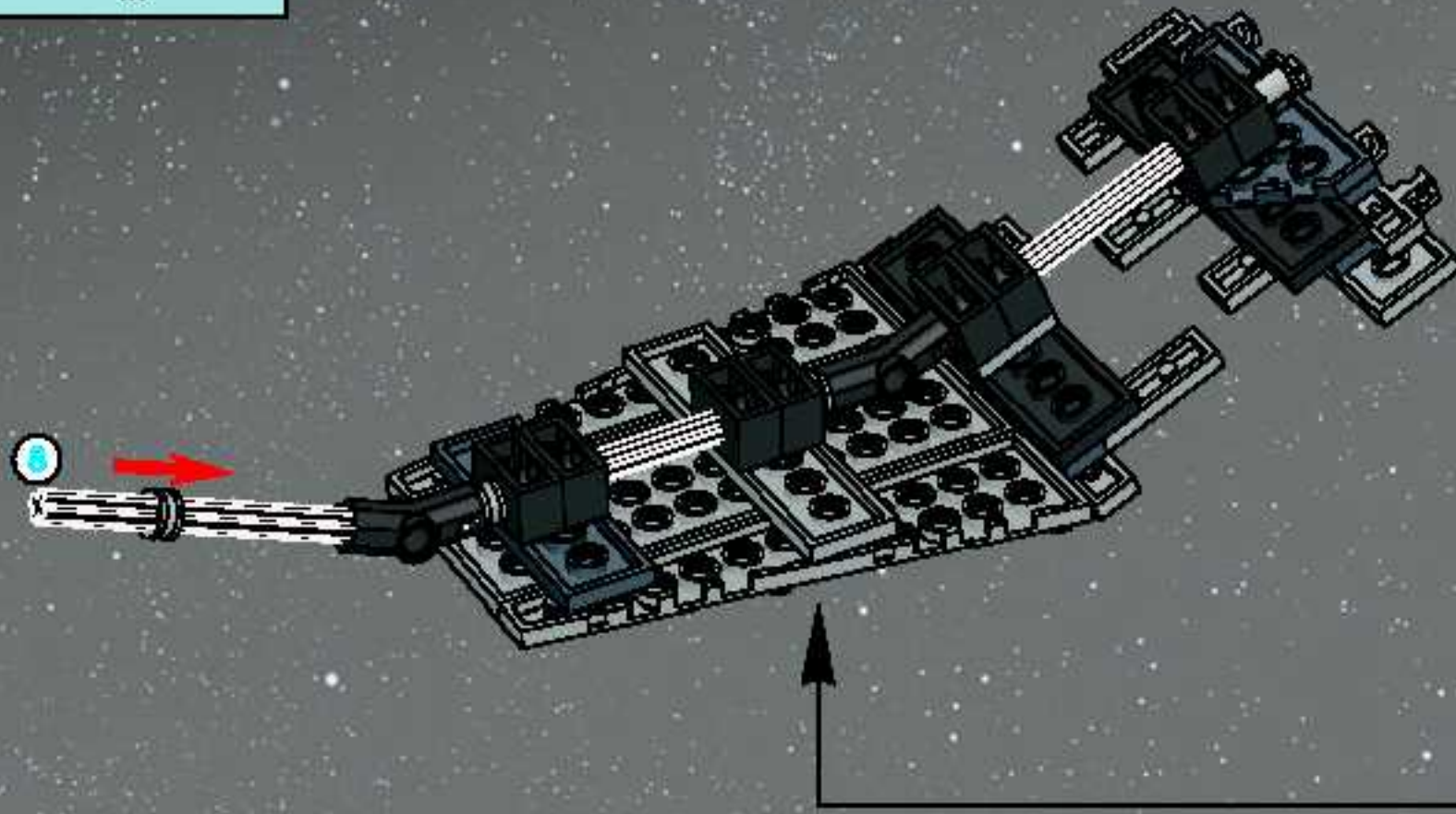

11

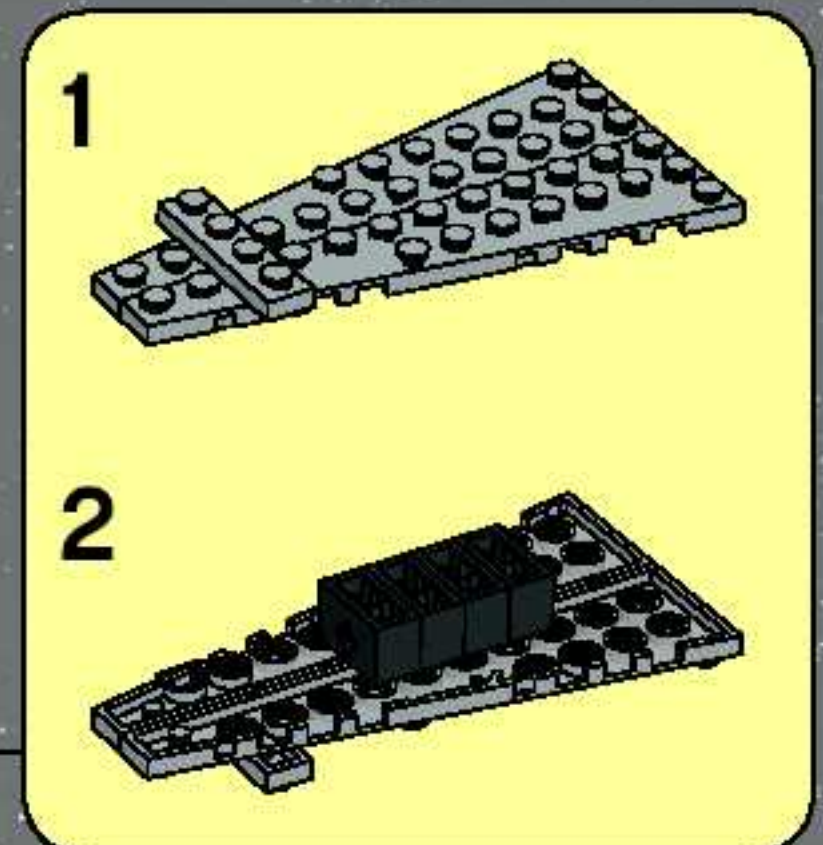
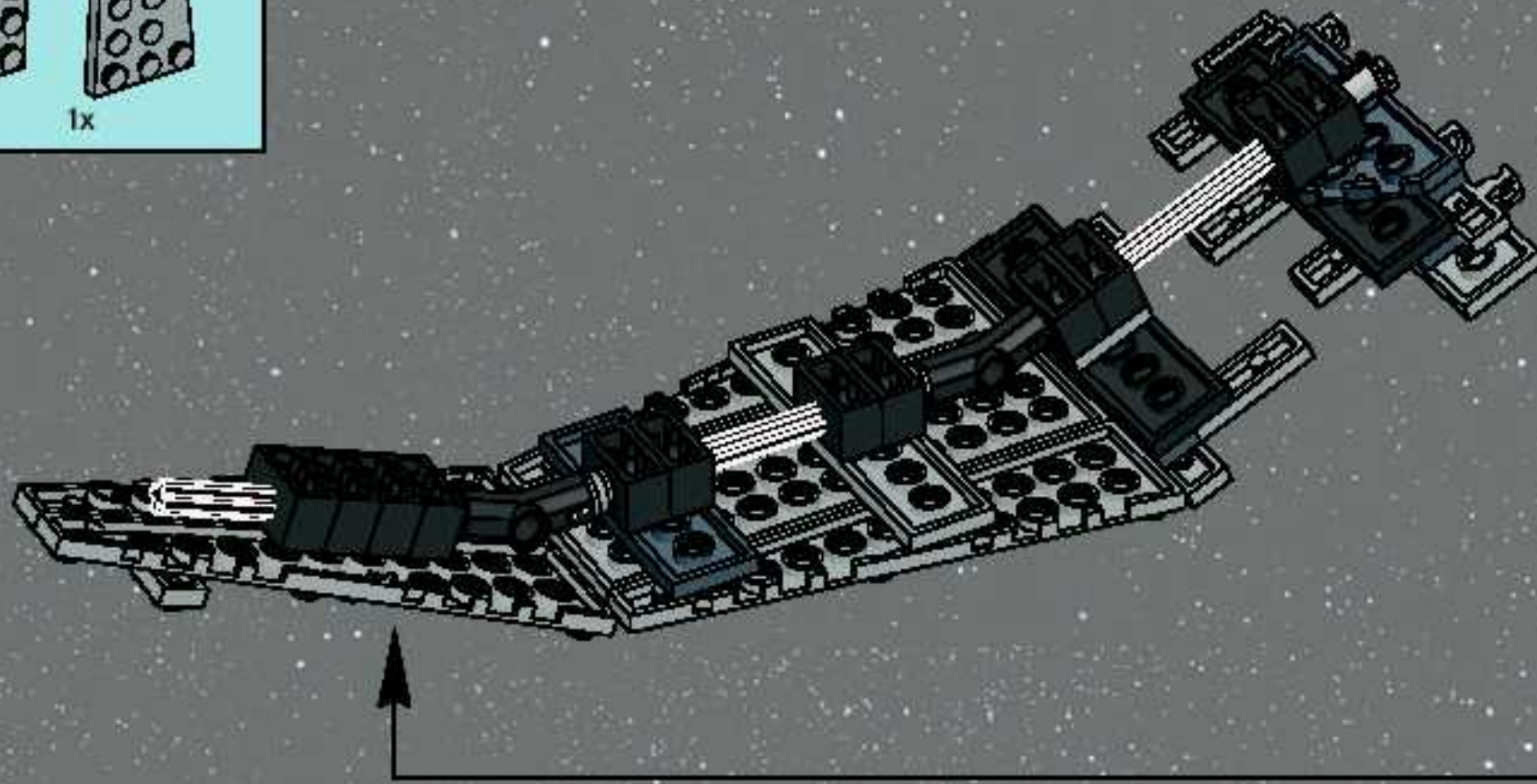

12

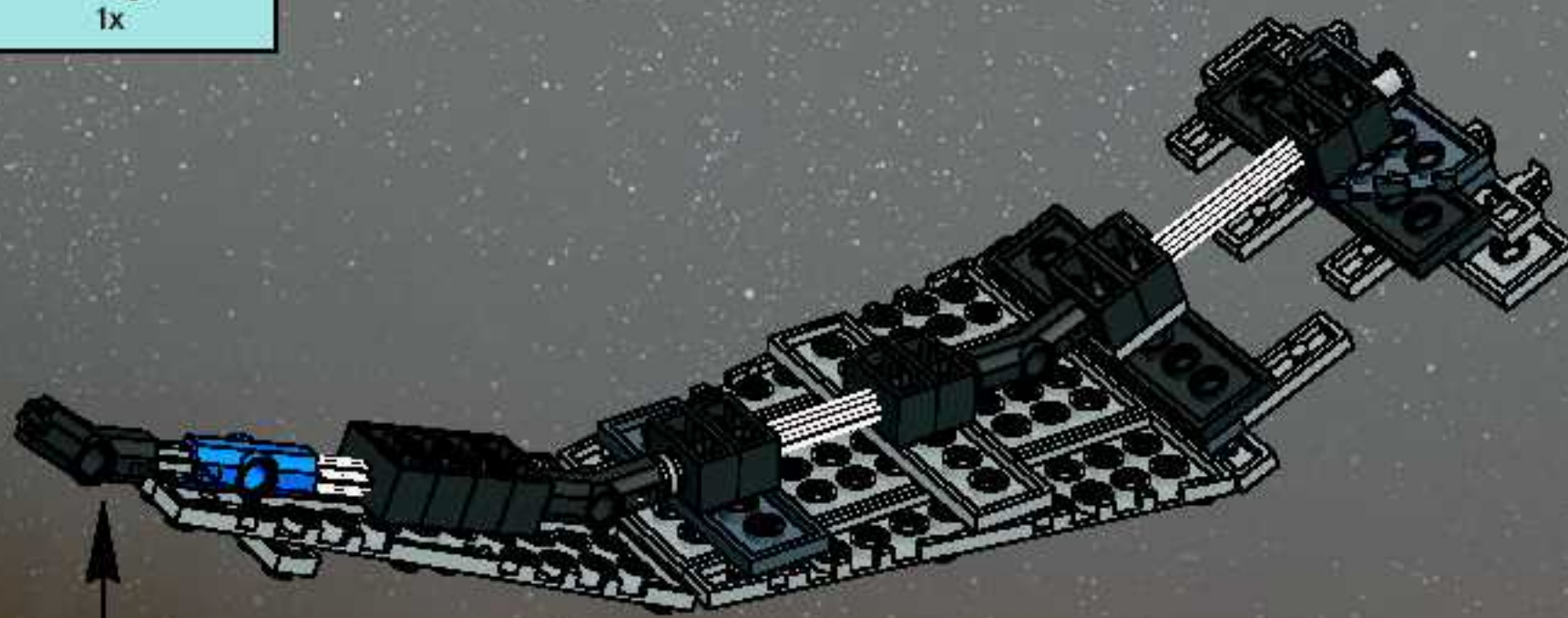

3x

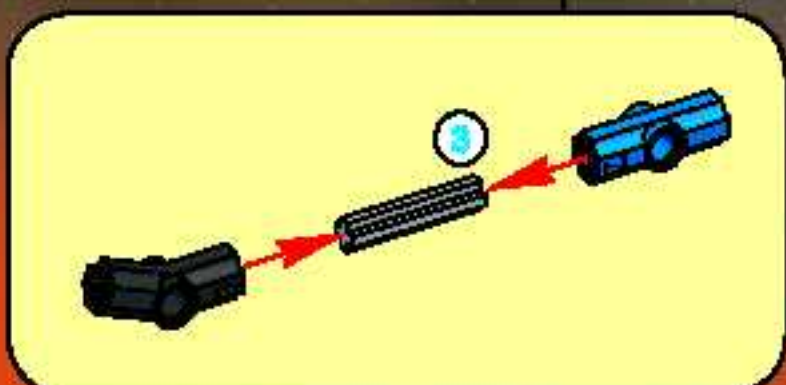



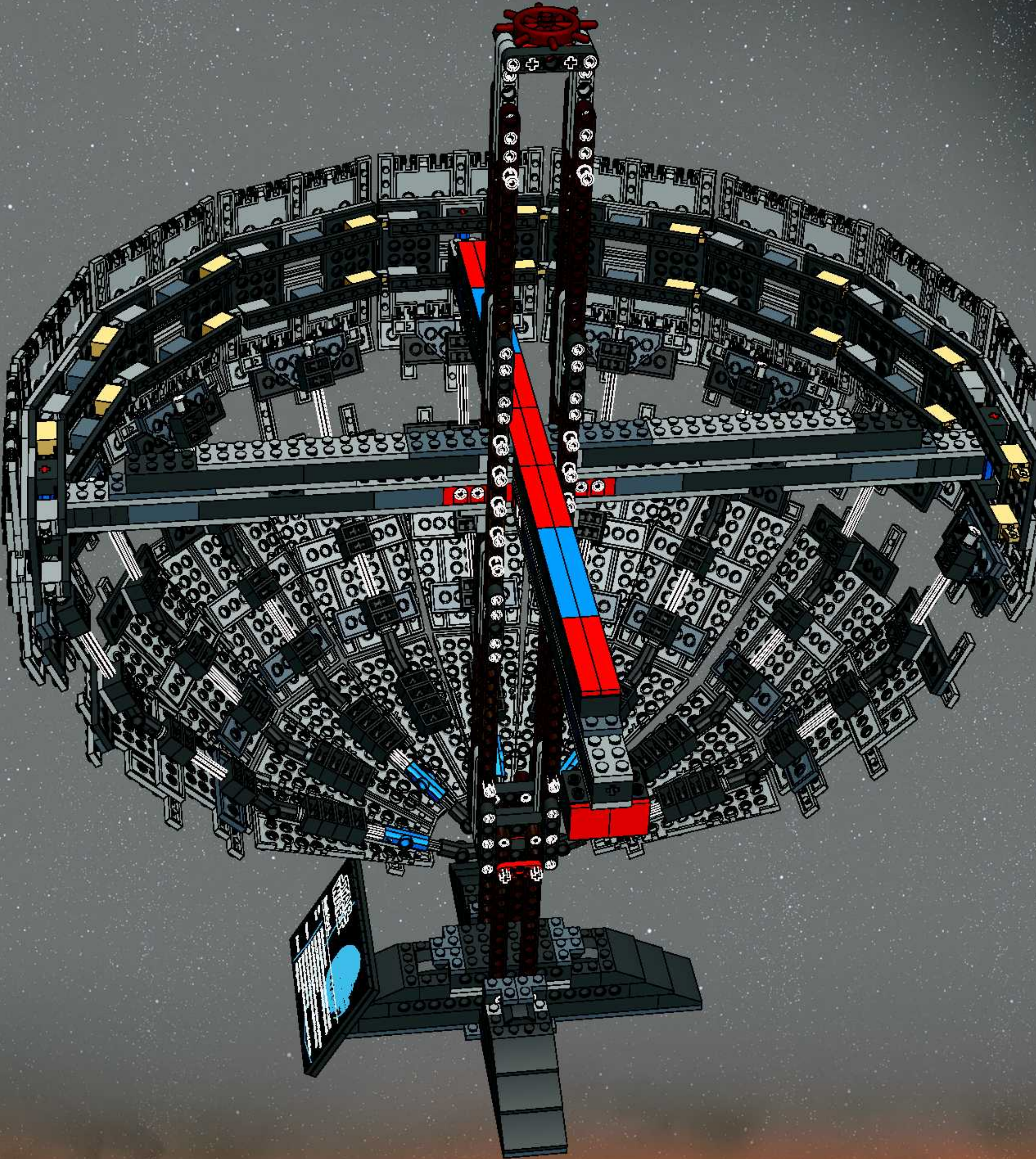



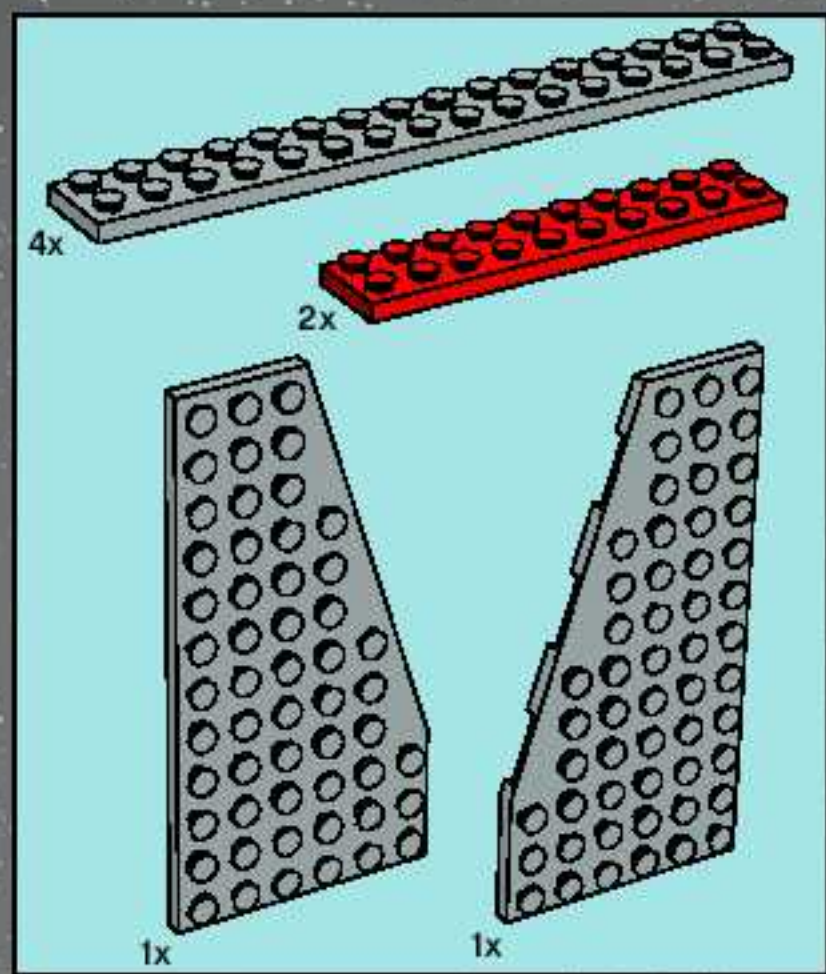
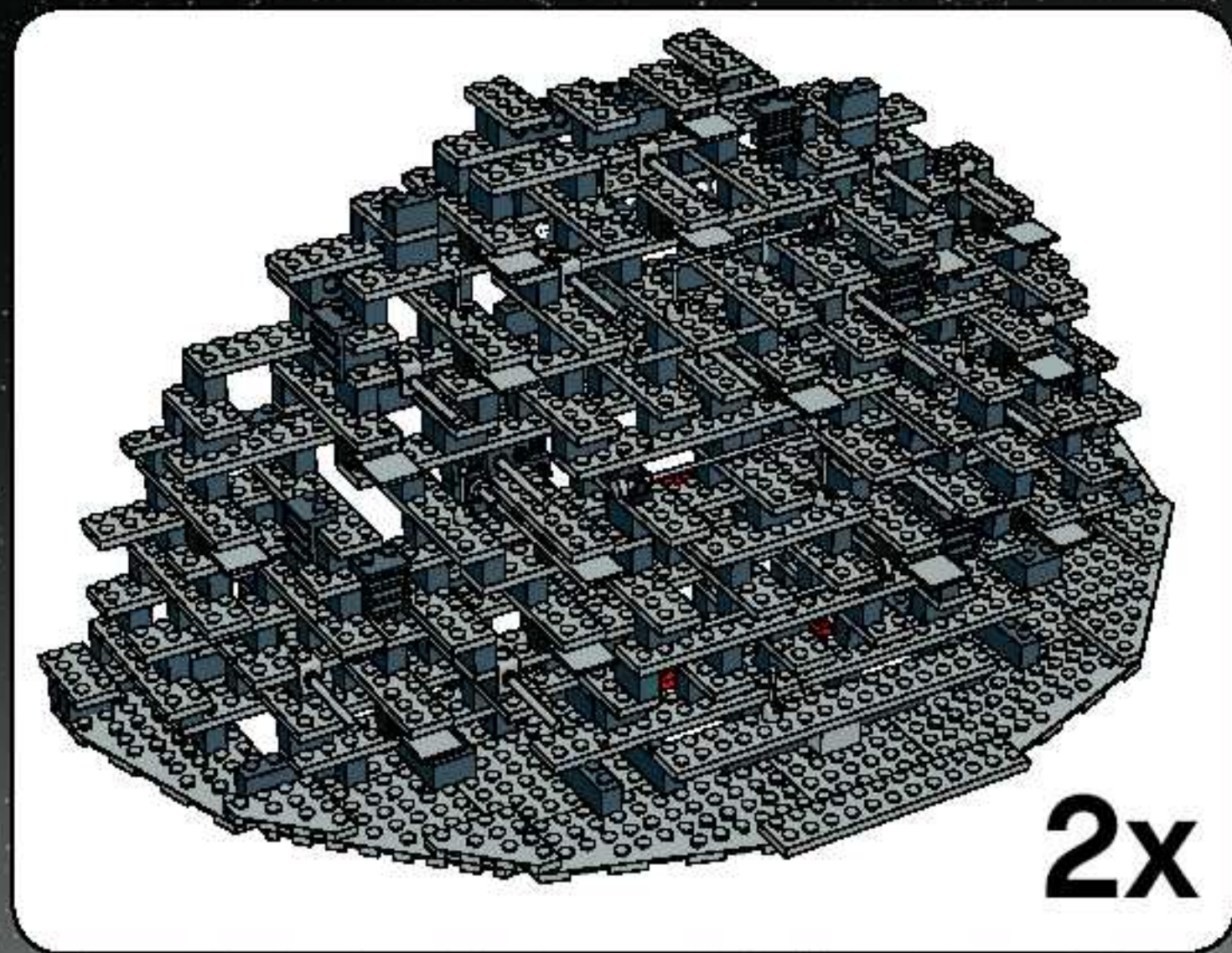

1

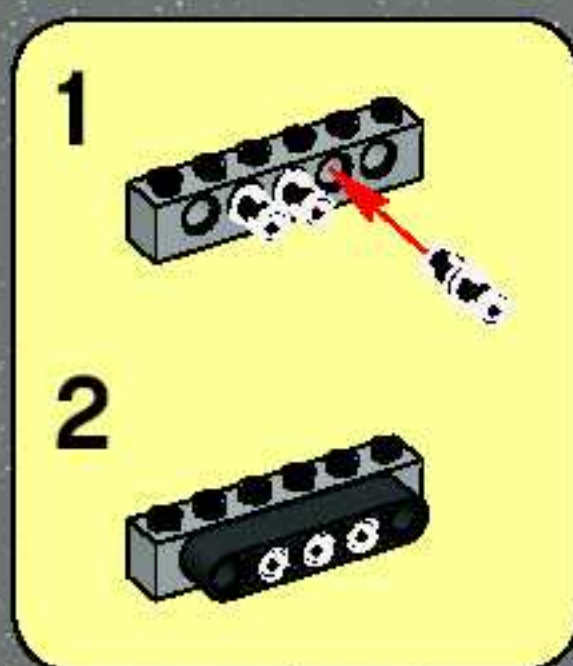
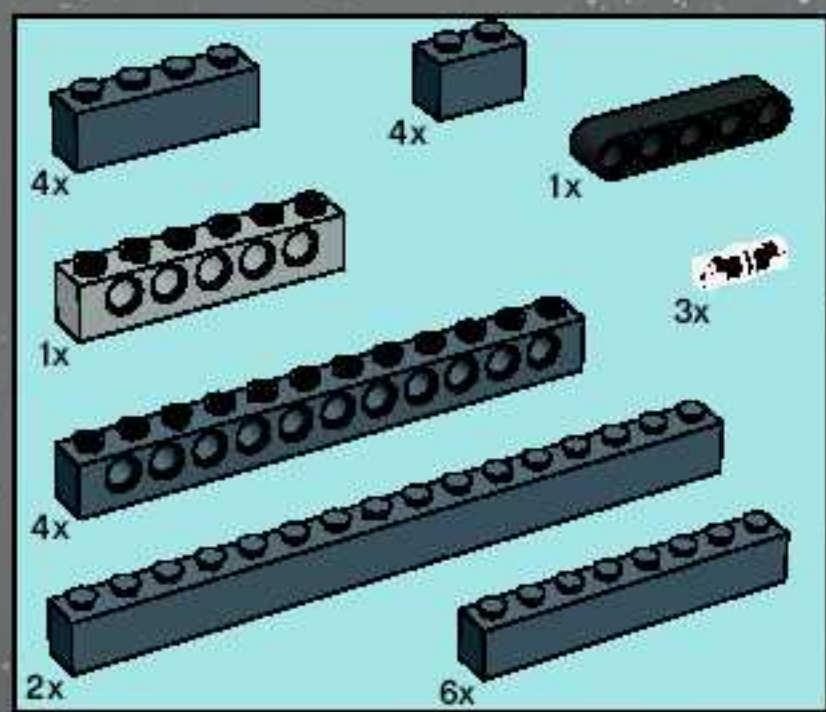
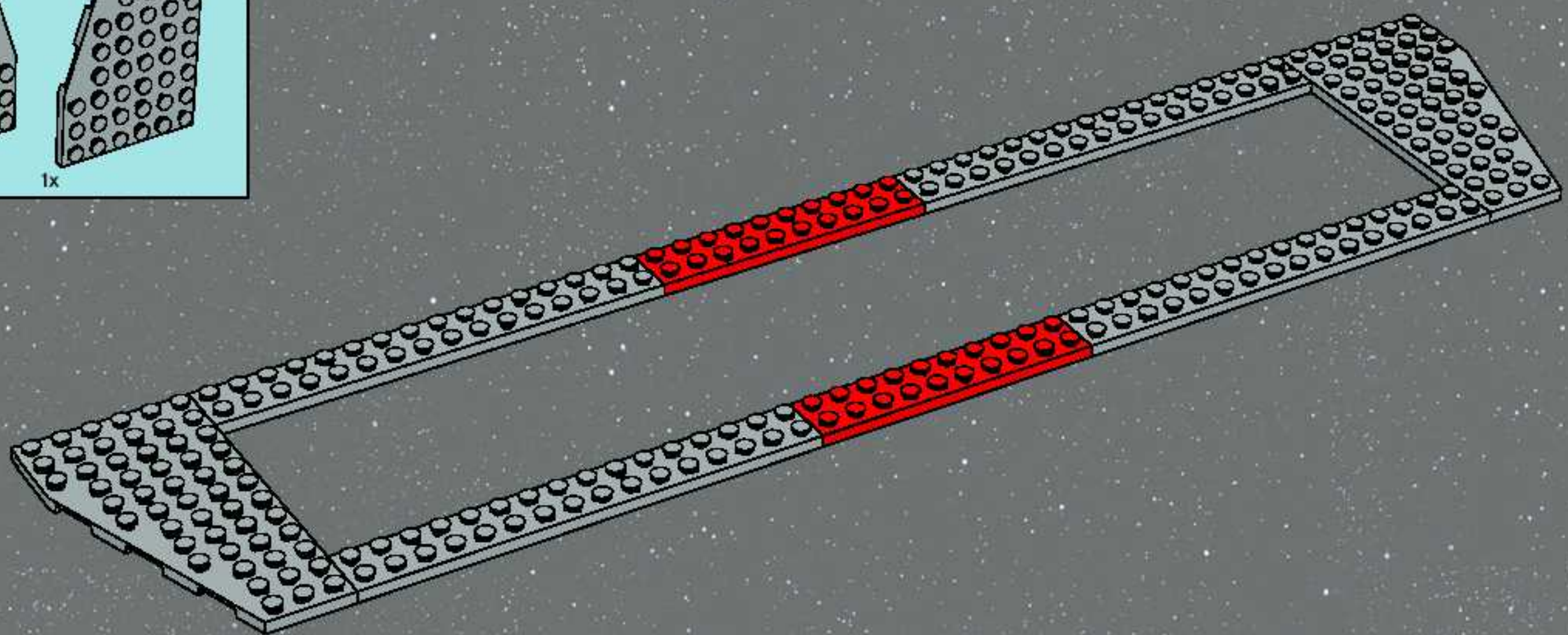

2

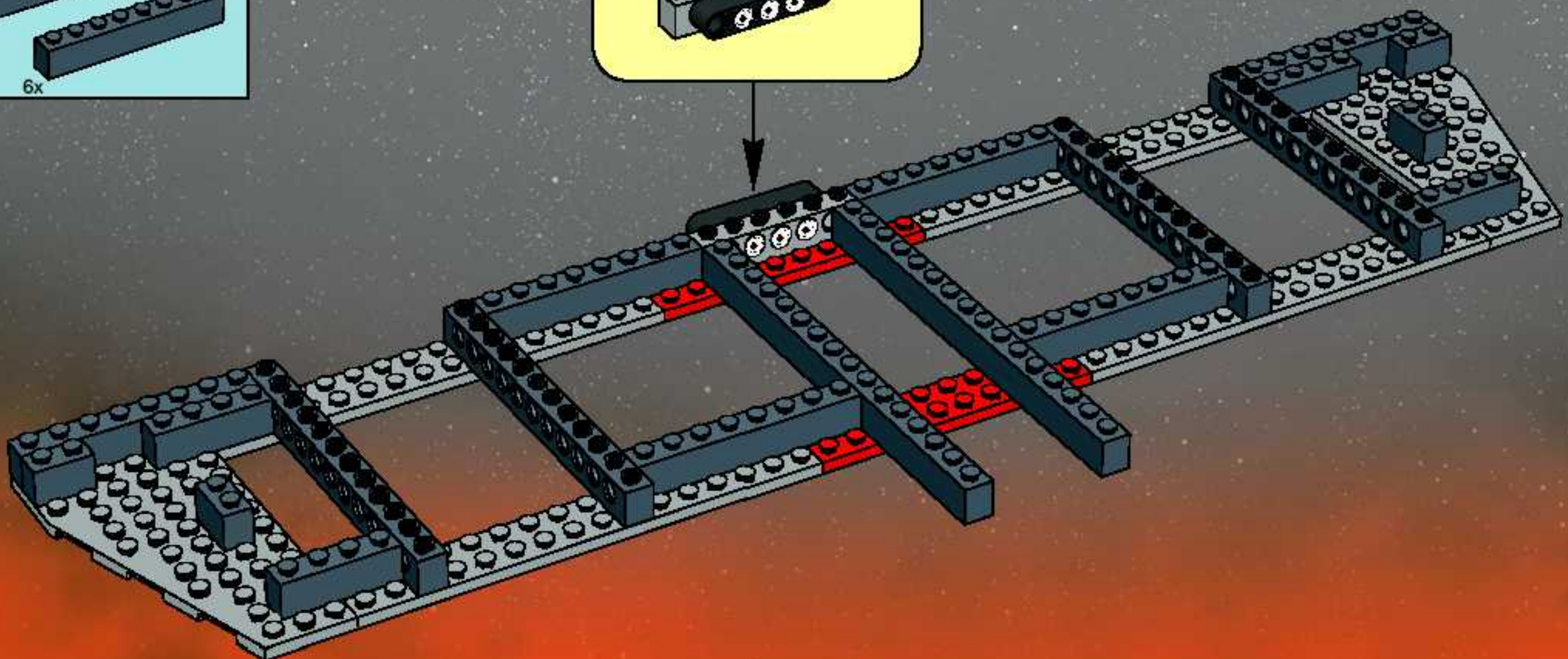



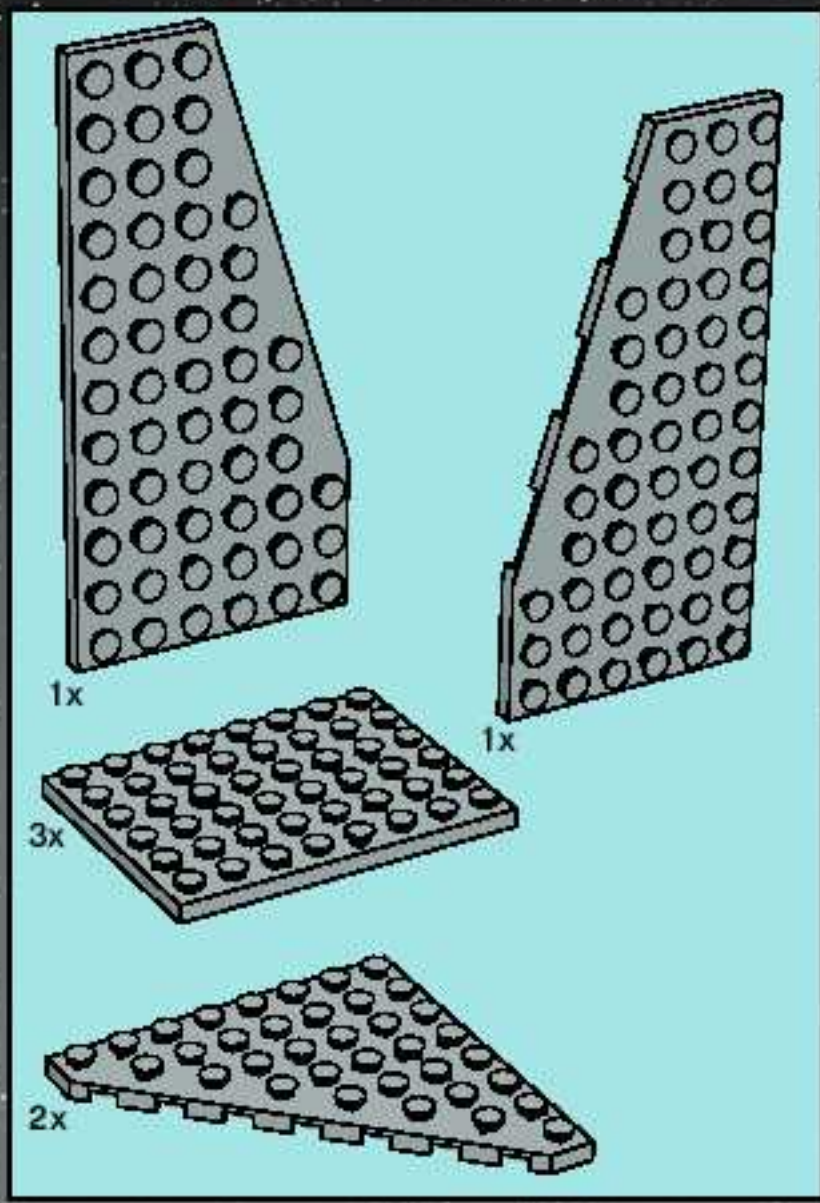

3

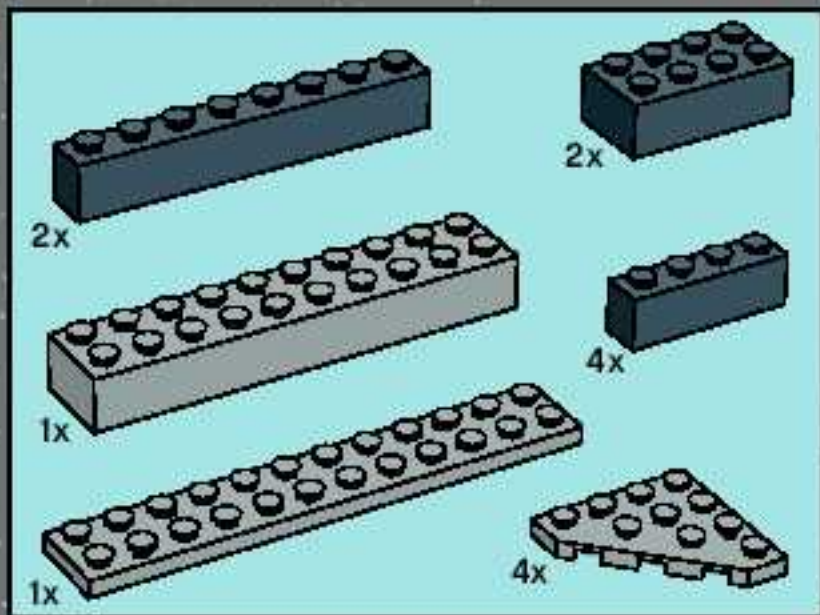
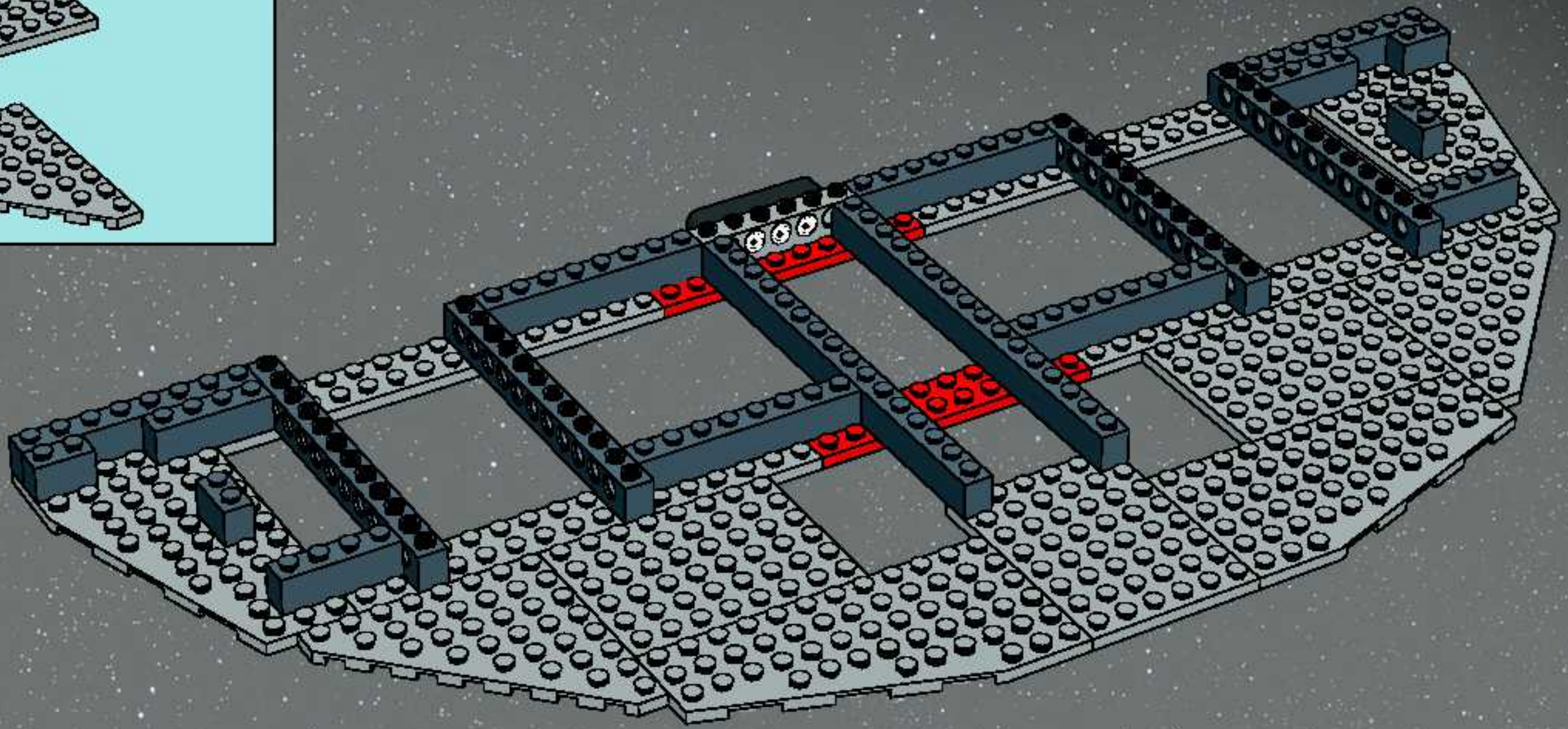

4

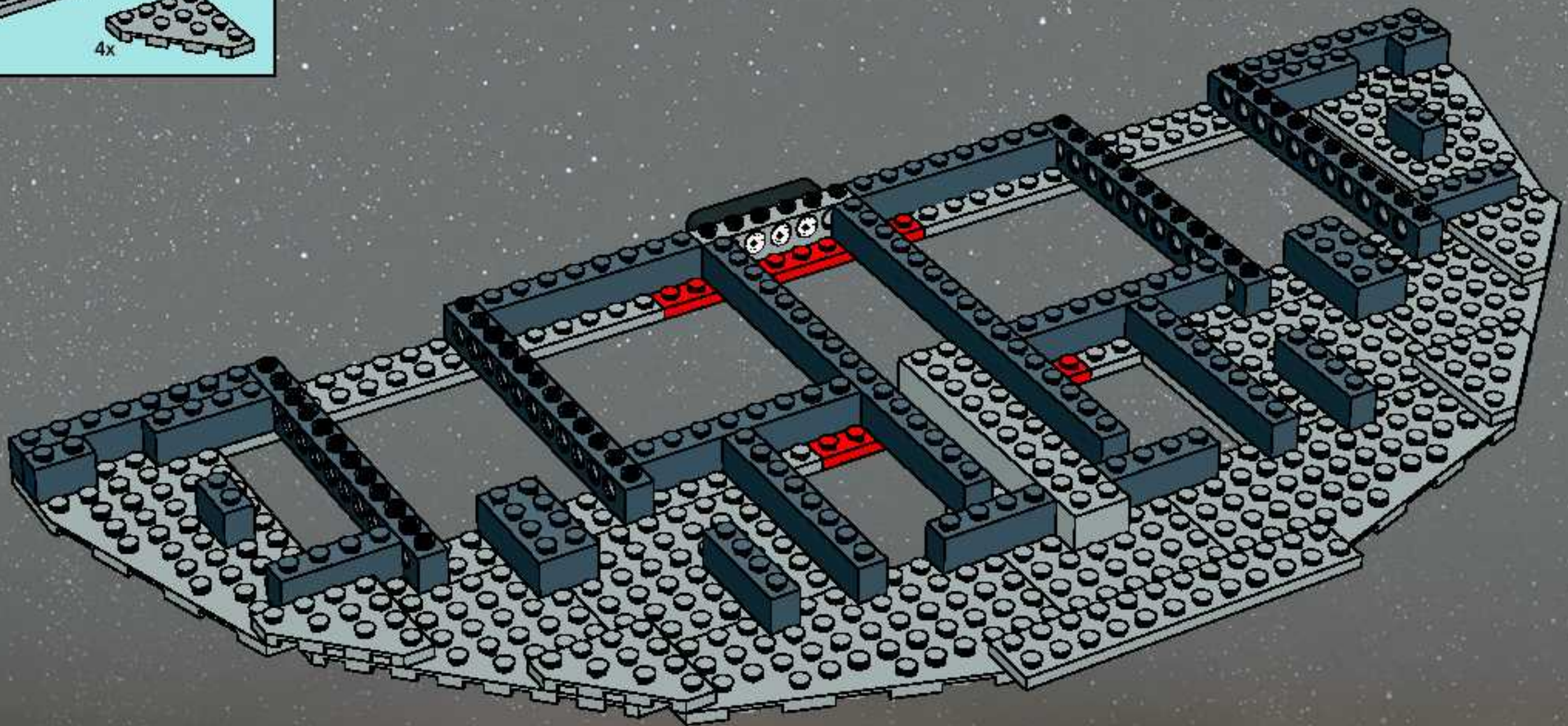



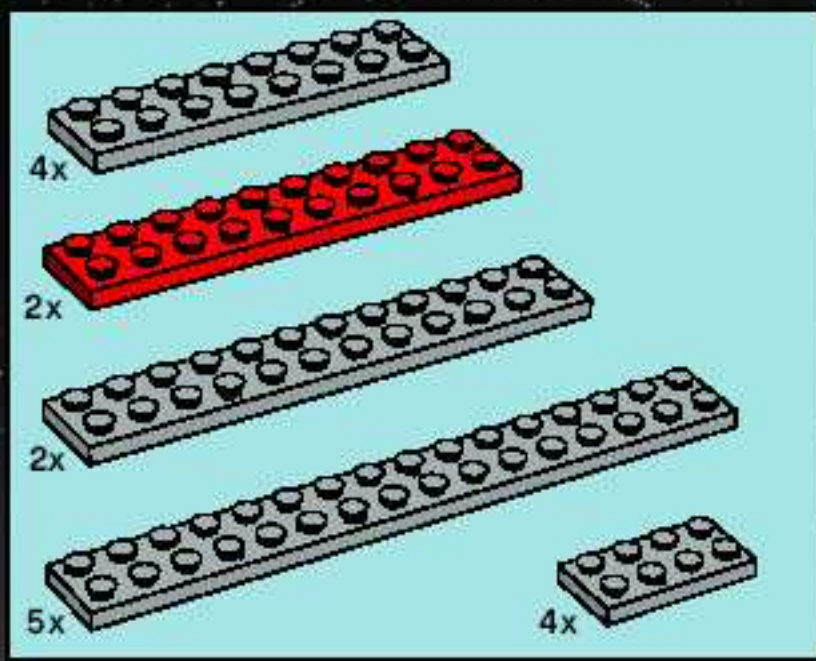

5

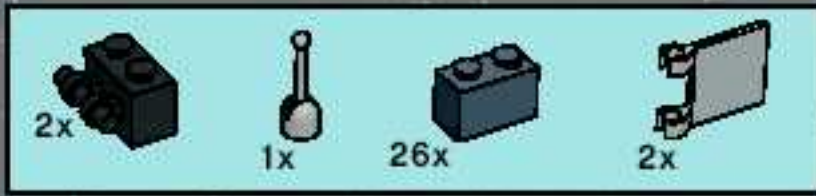
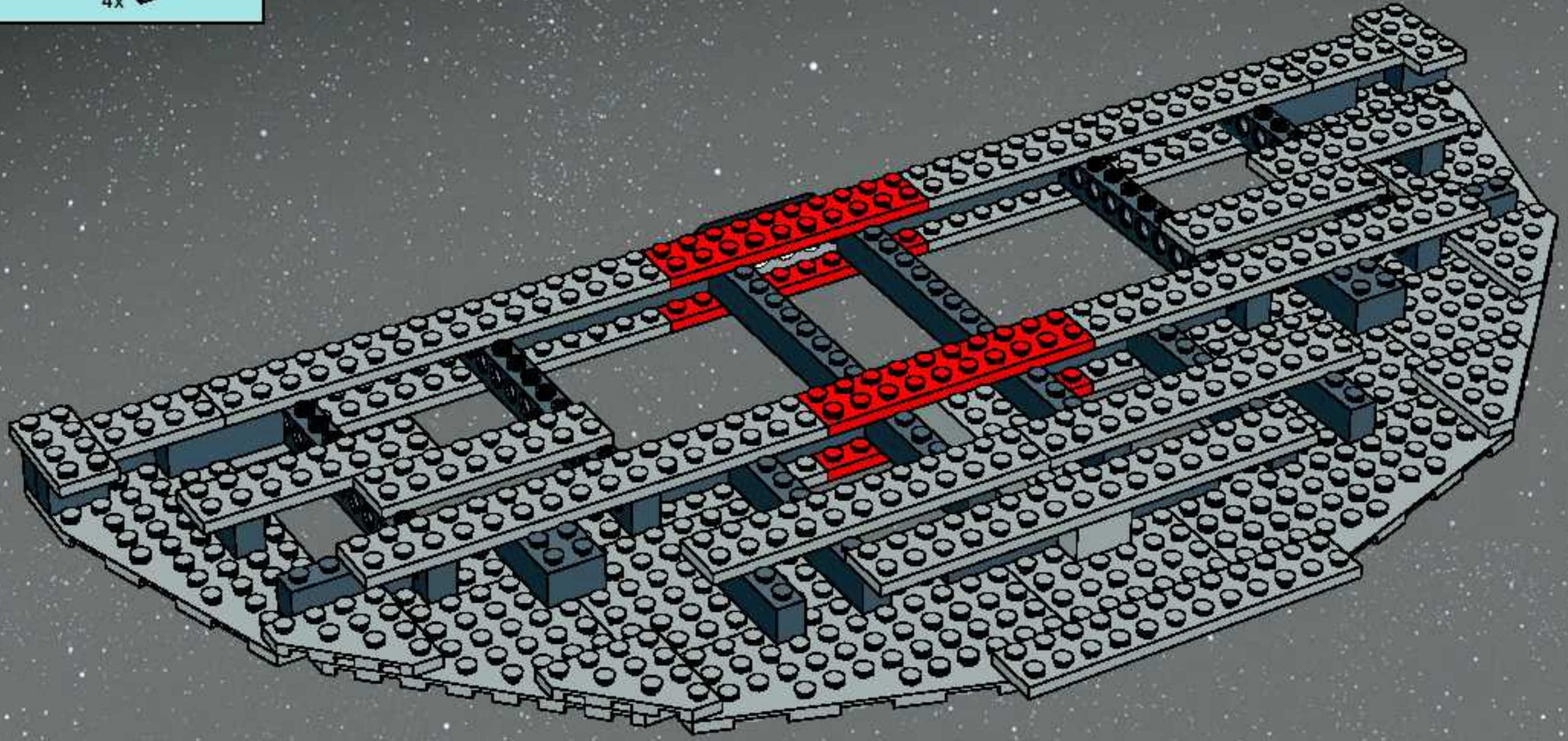

6

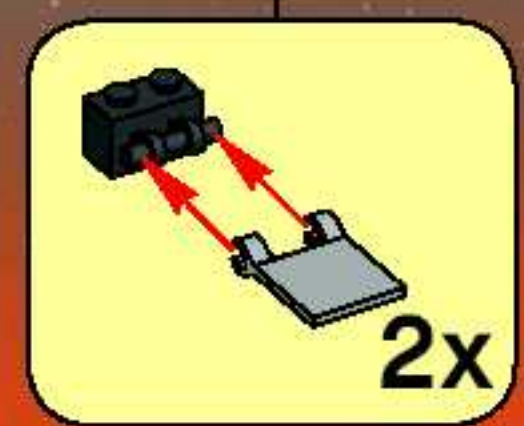
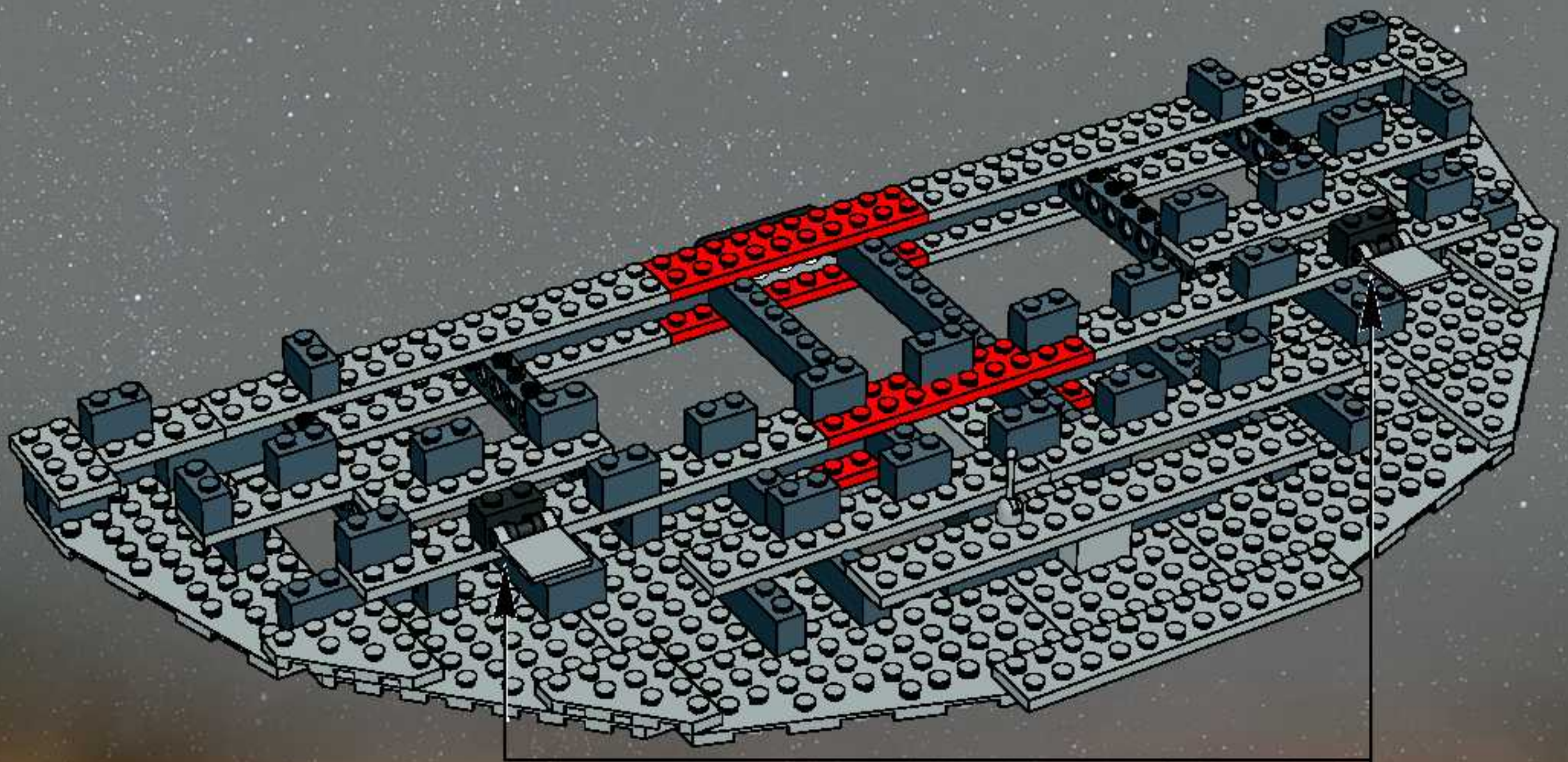





7

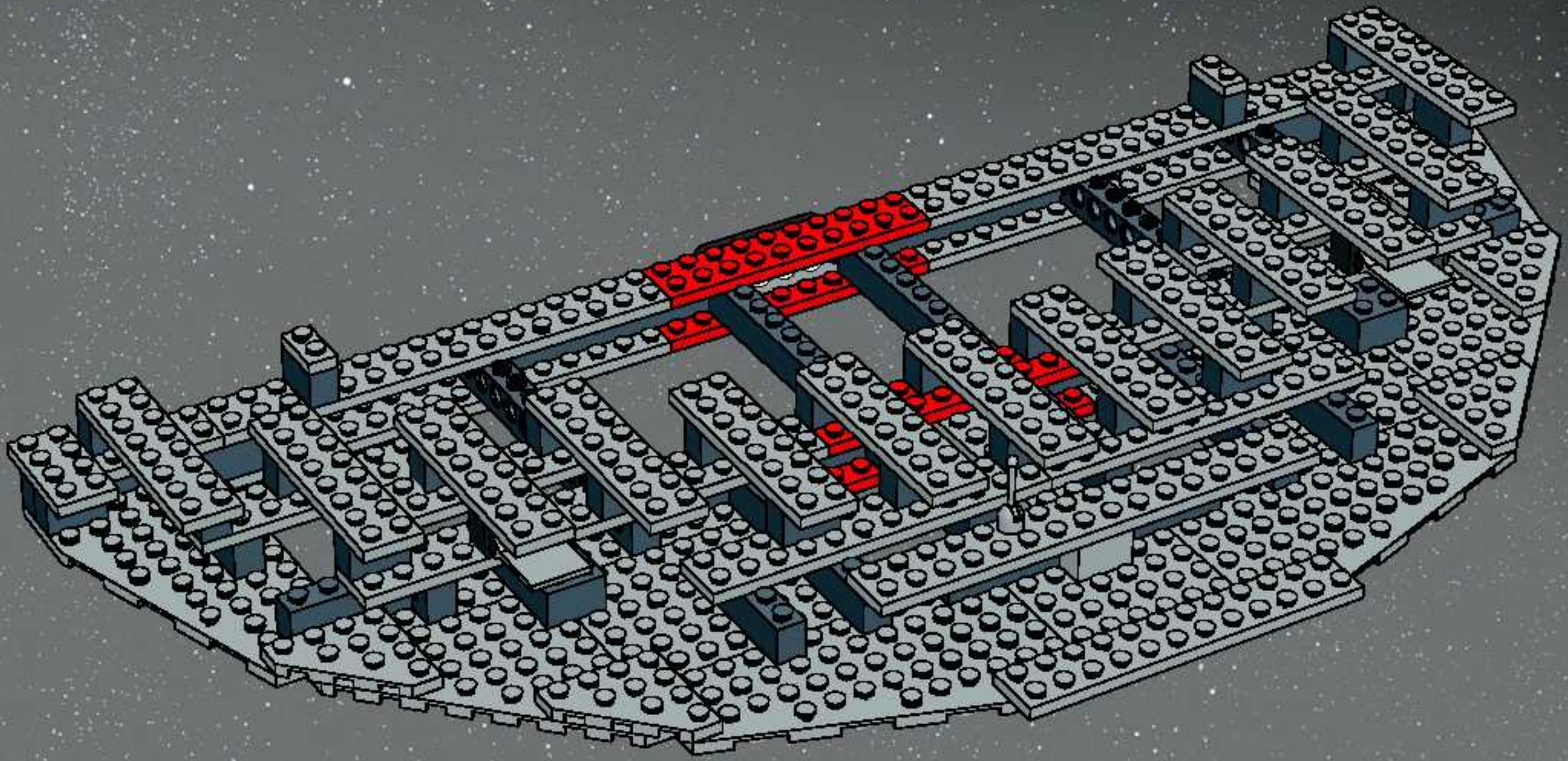

8

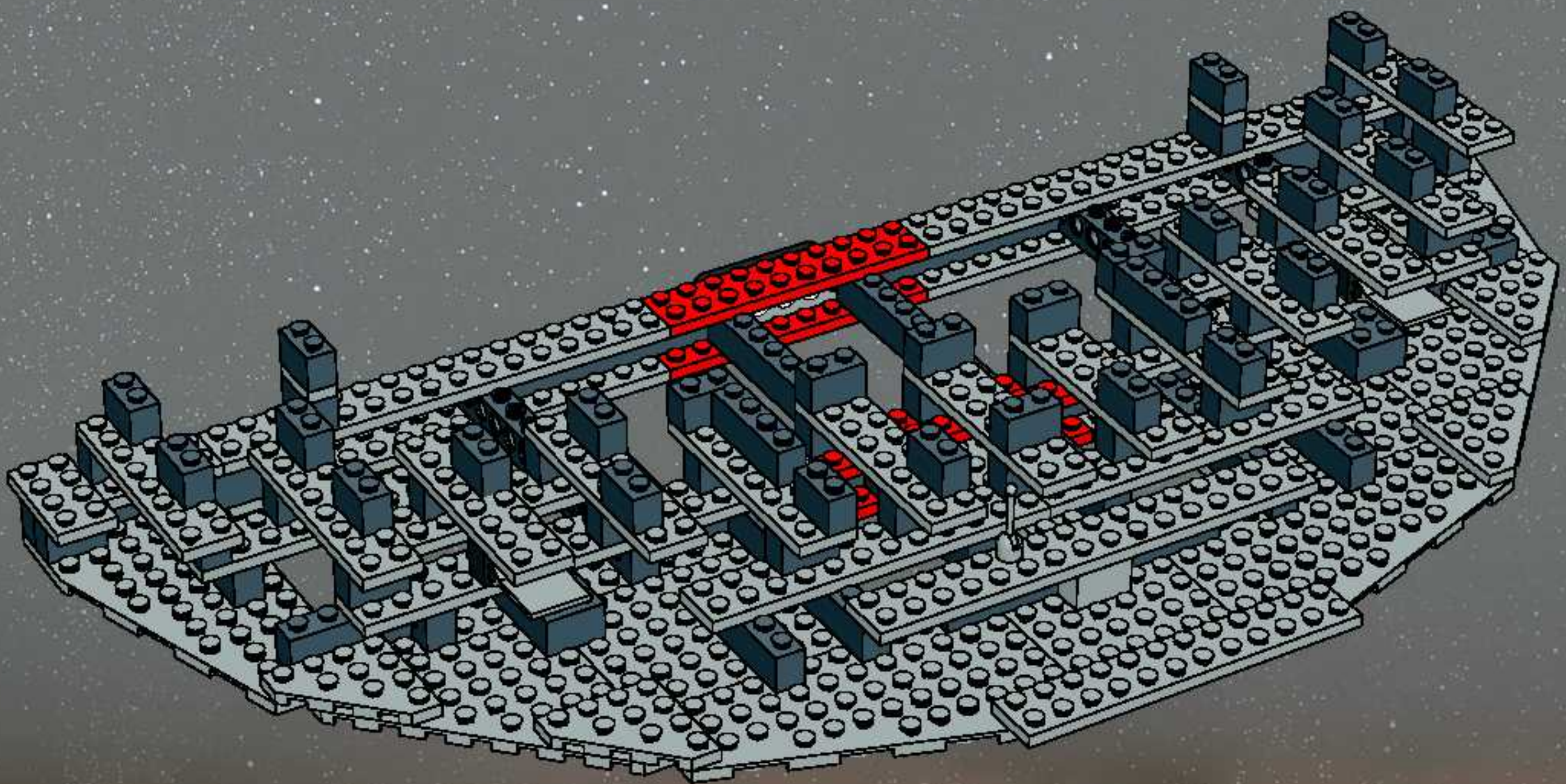



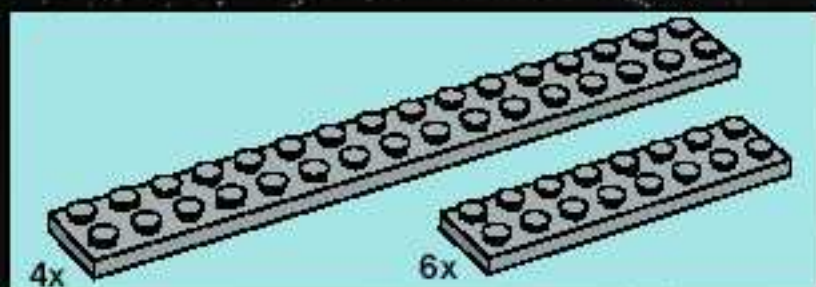

9

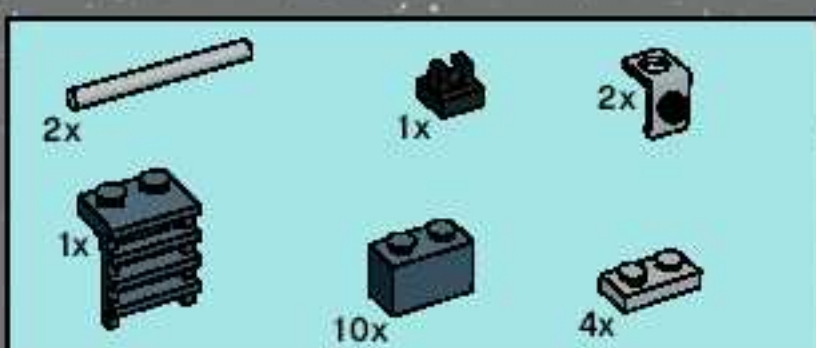
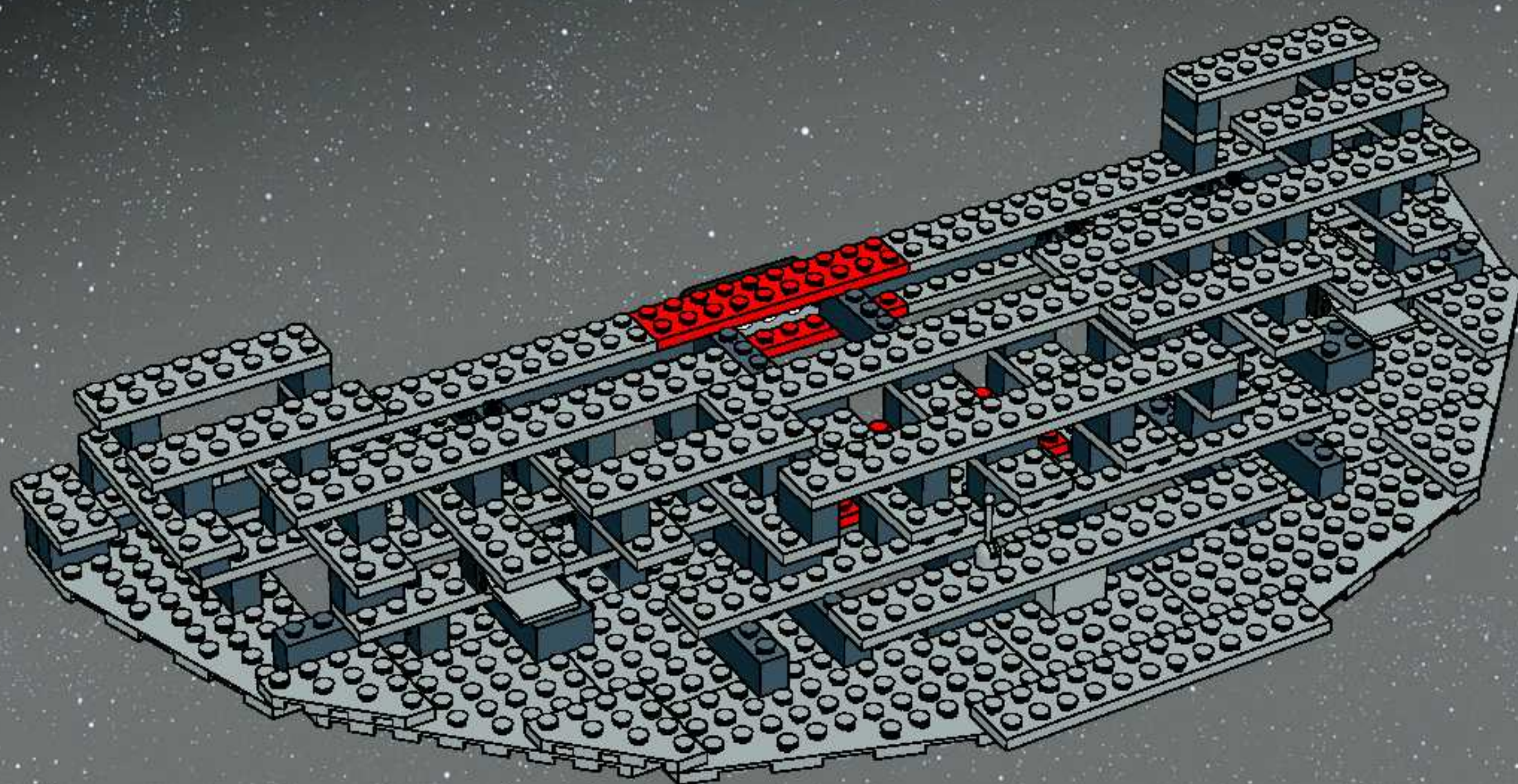

10

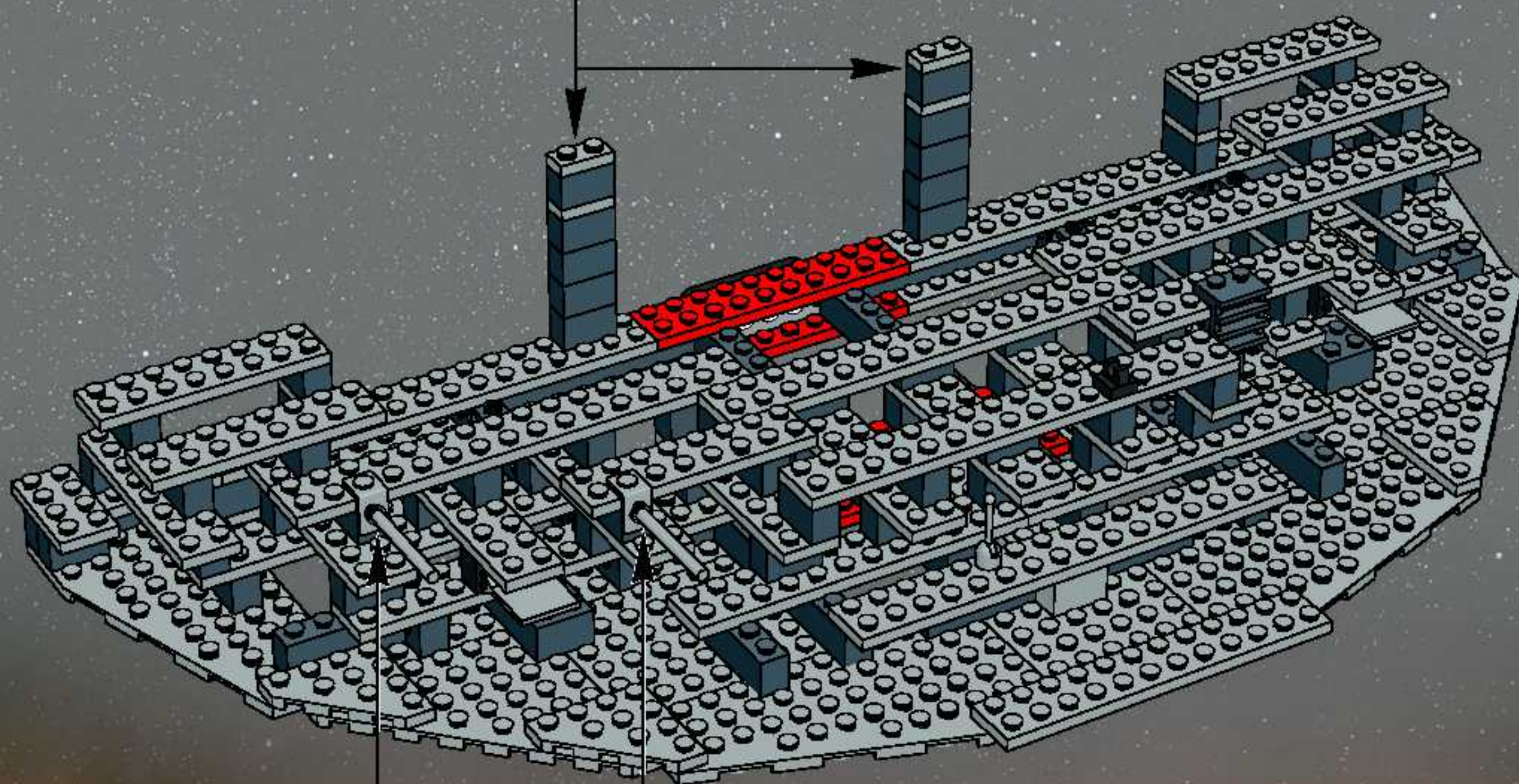
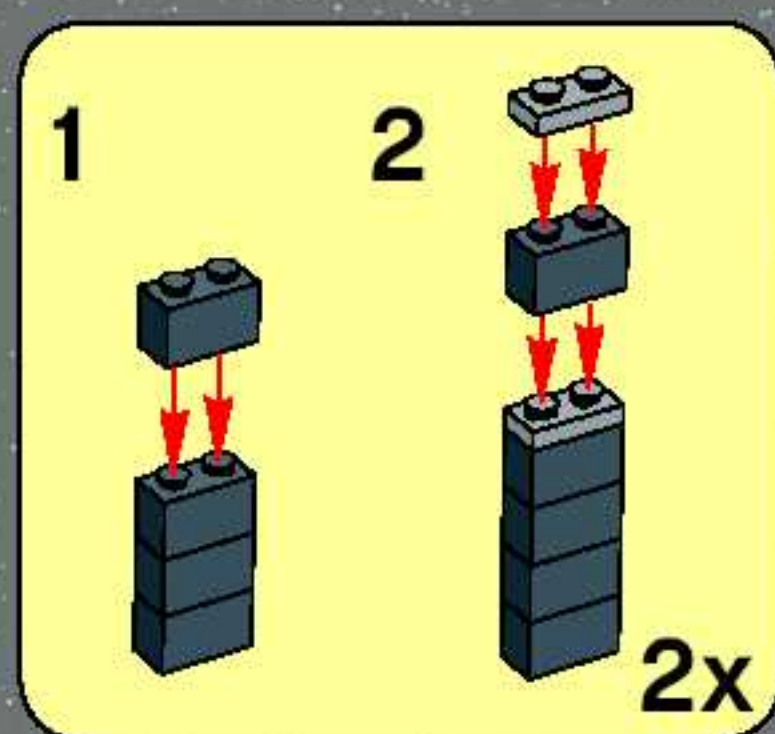



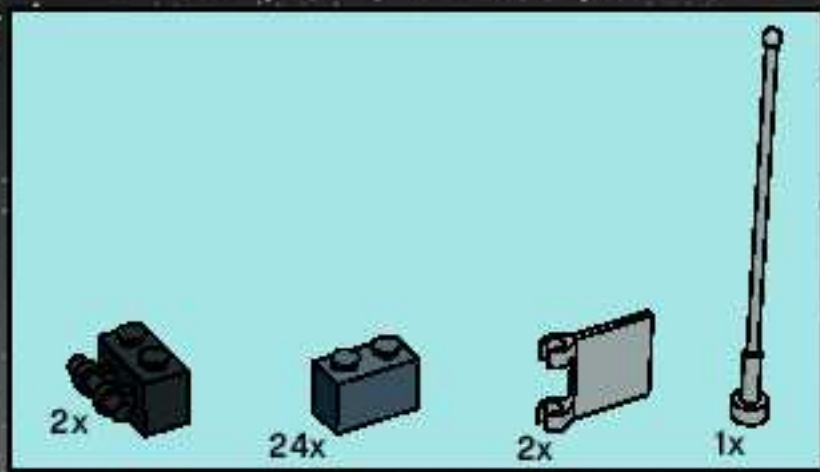

11

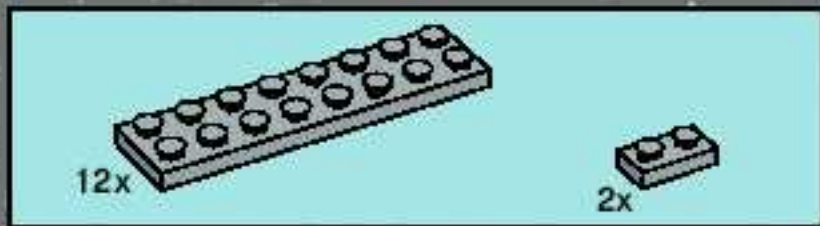
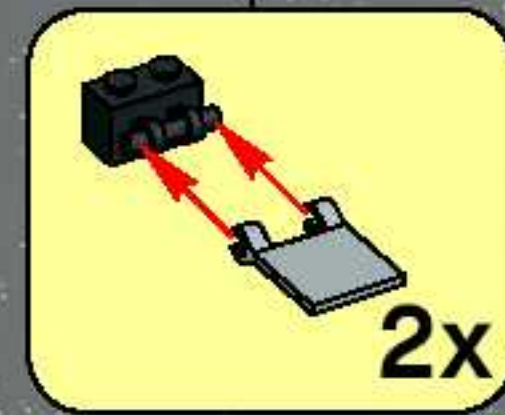
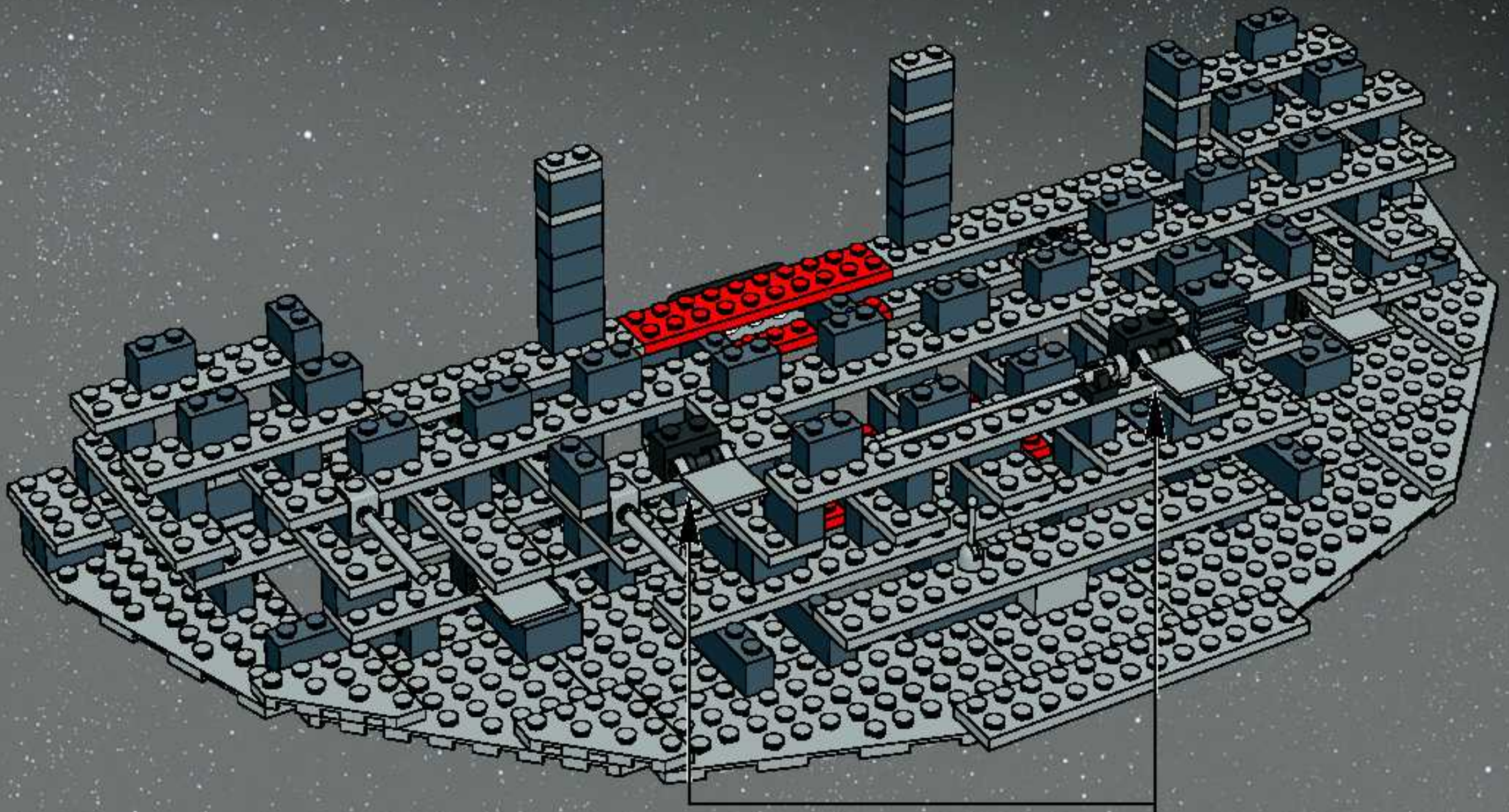

12

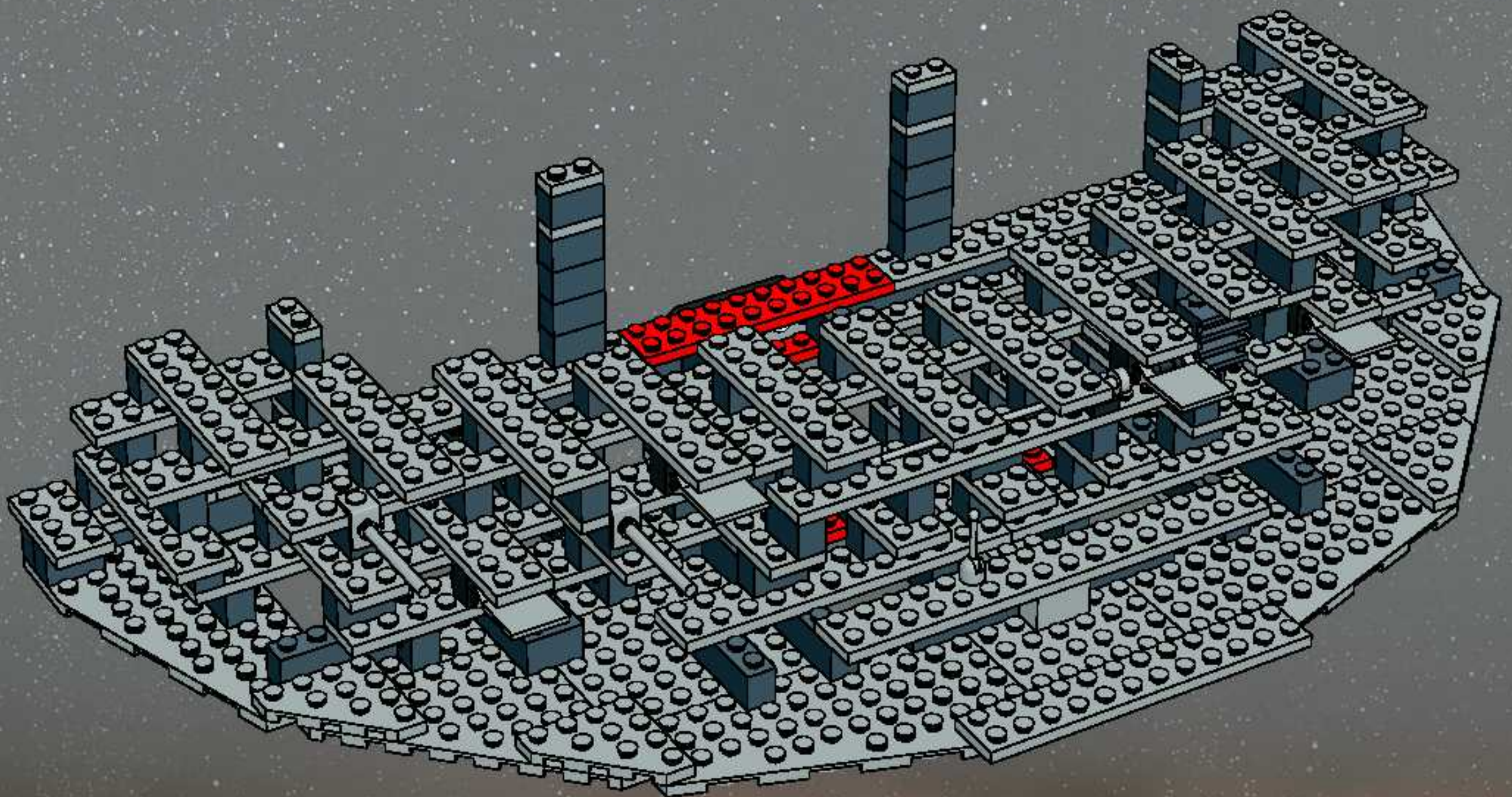





24x

13

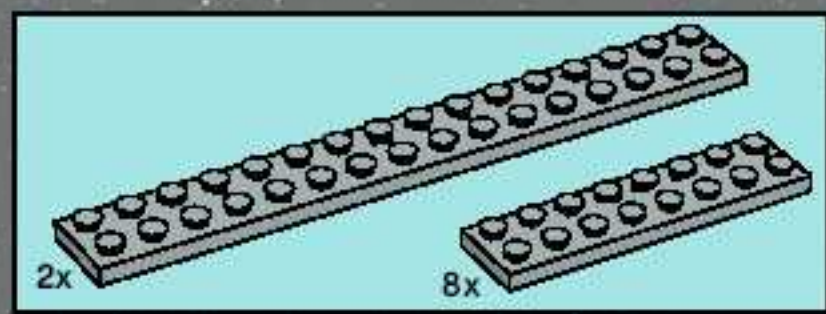
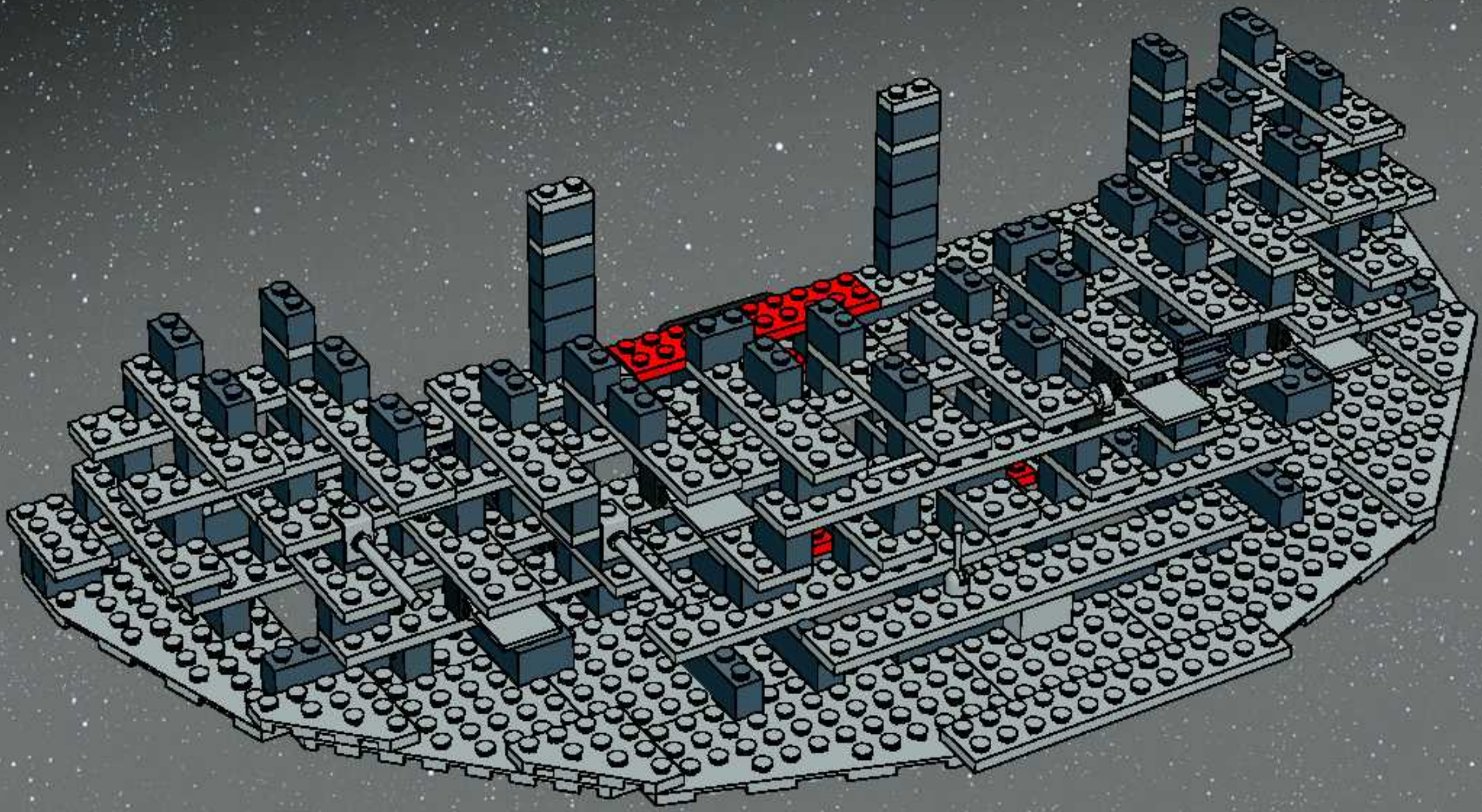

2x

8x

14

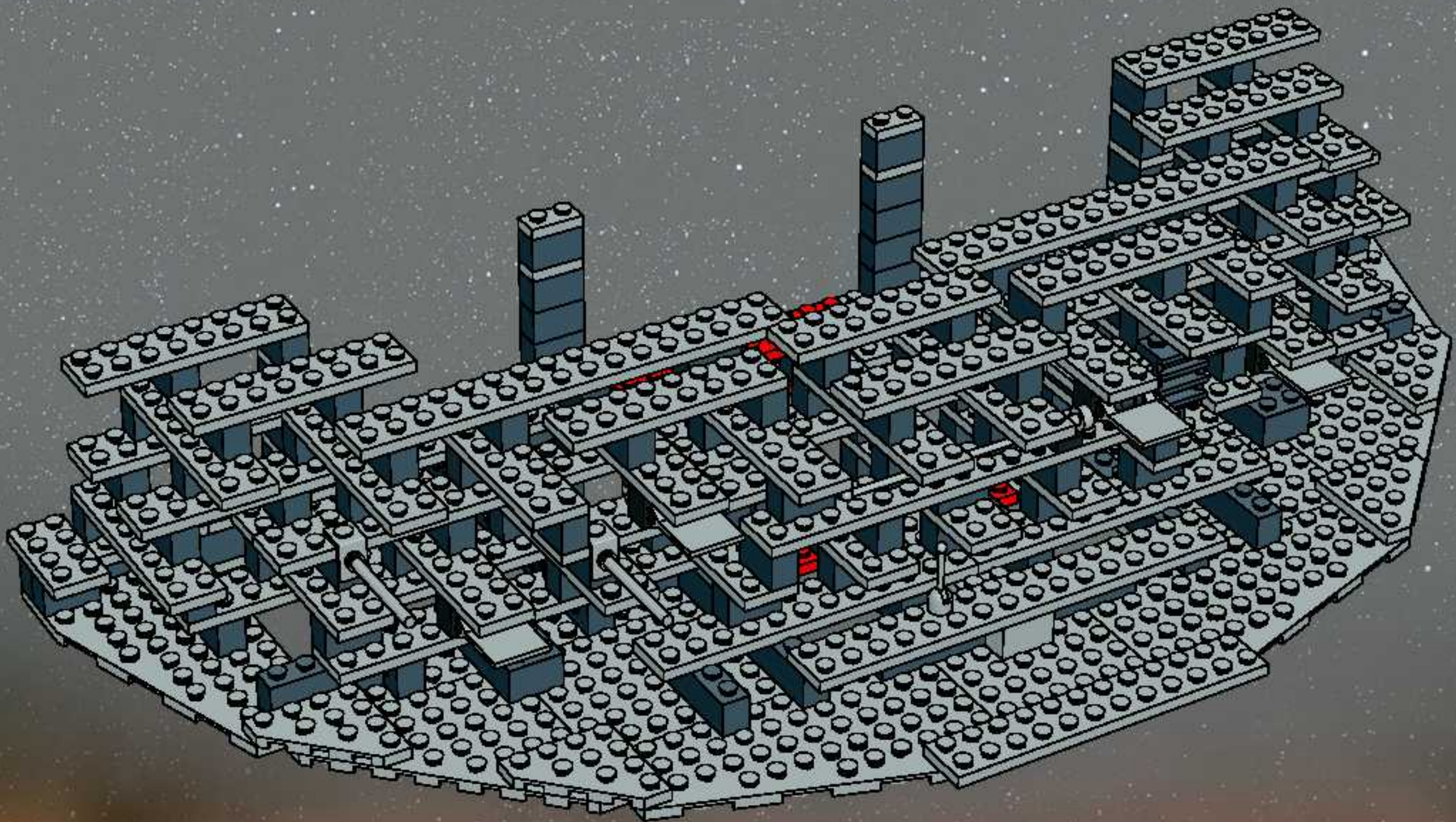



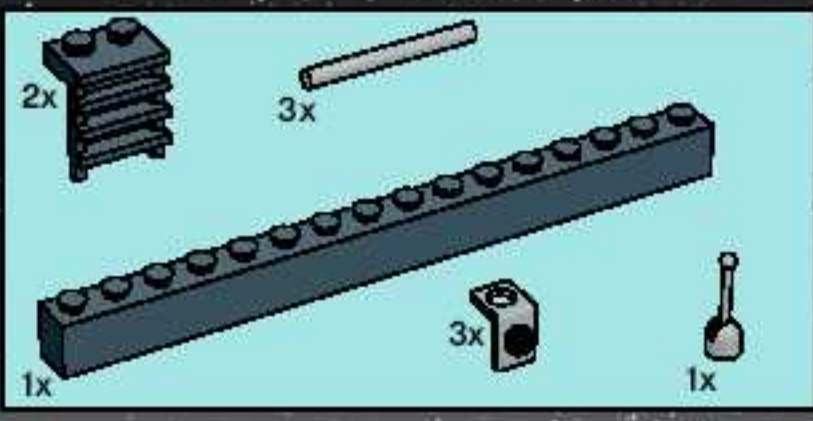

15

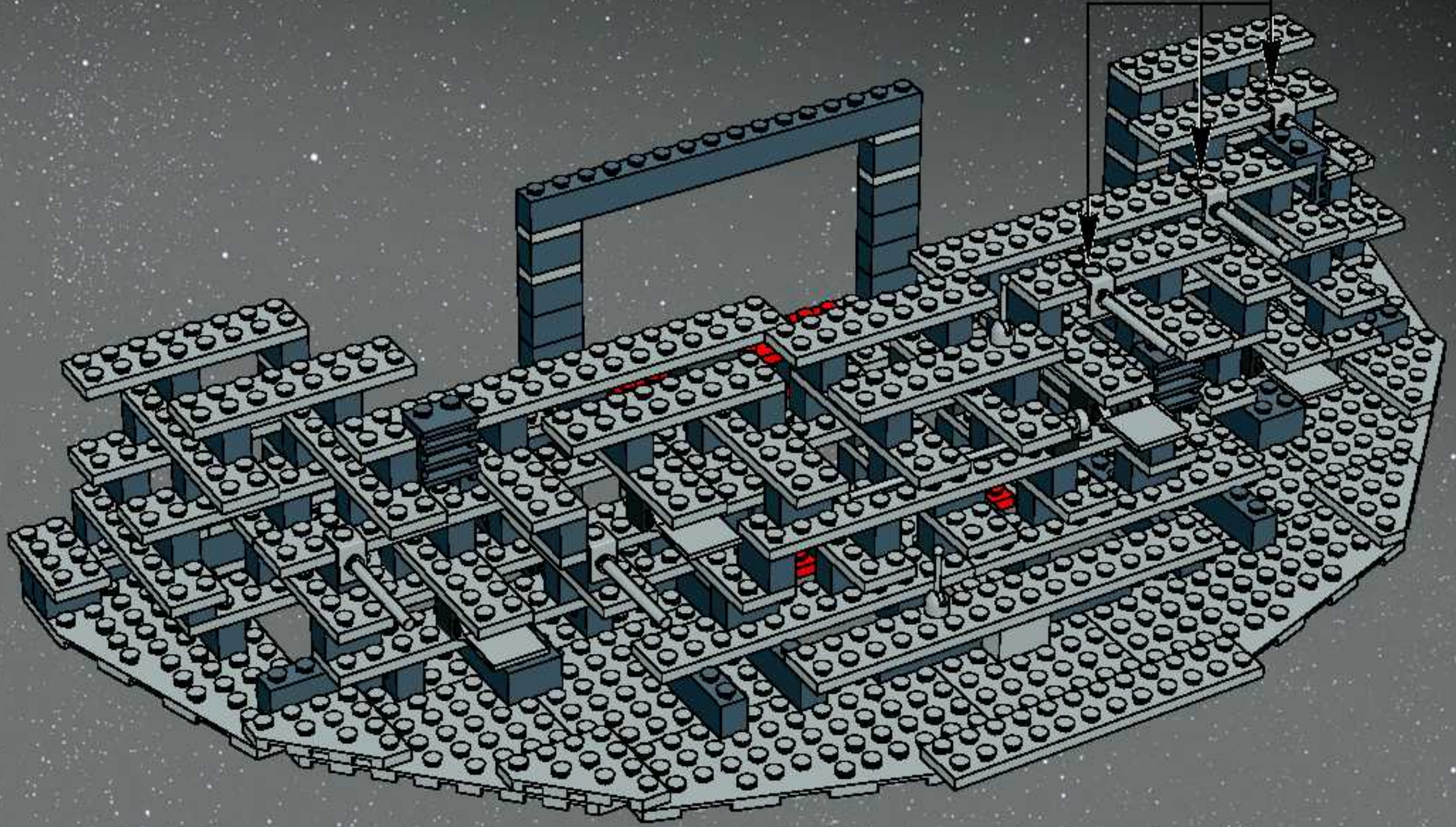

16

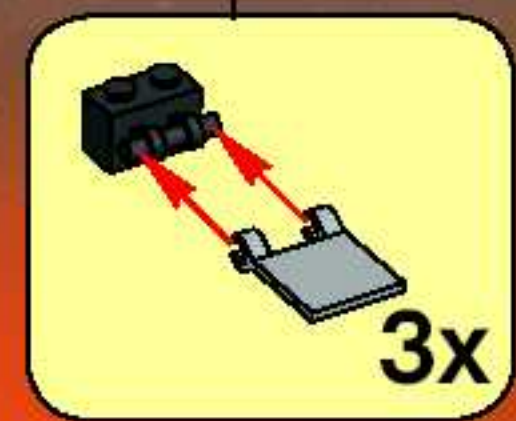
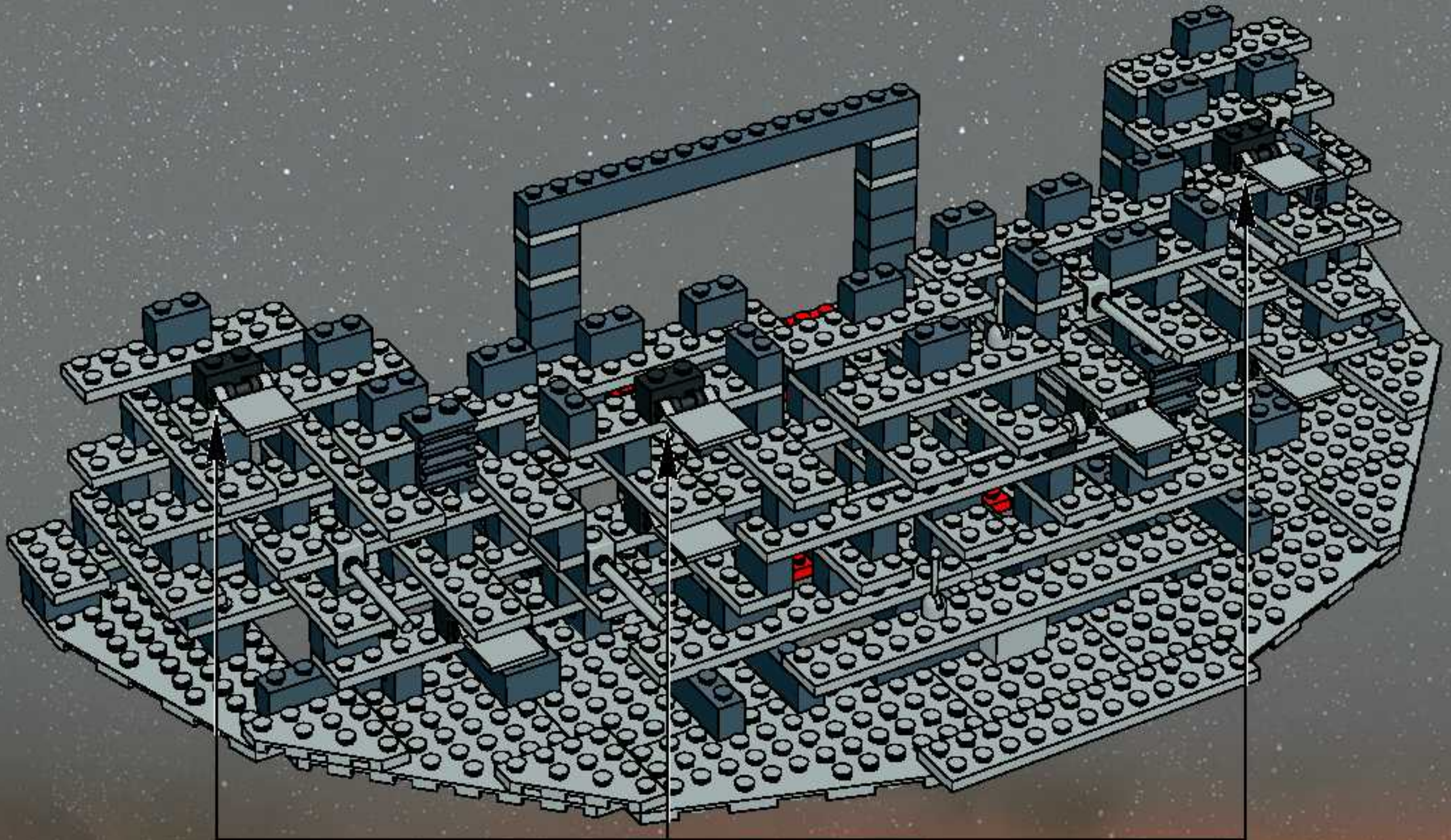





11x

17

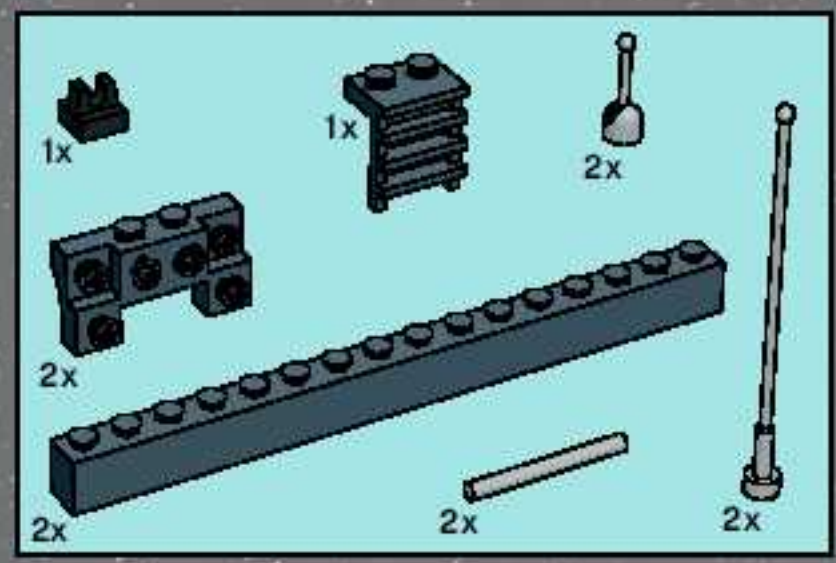
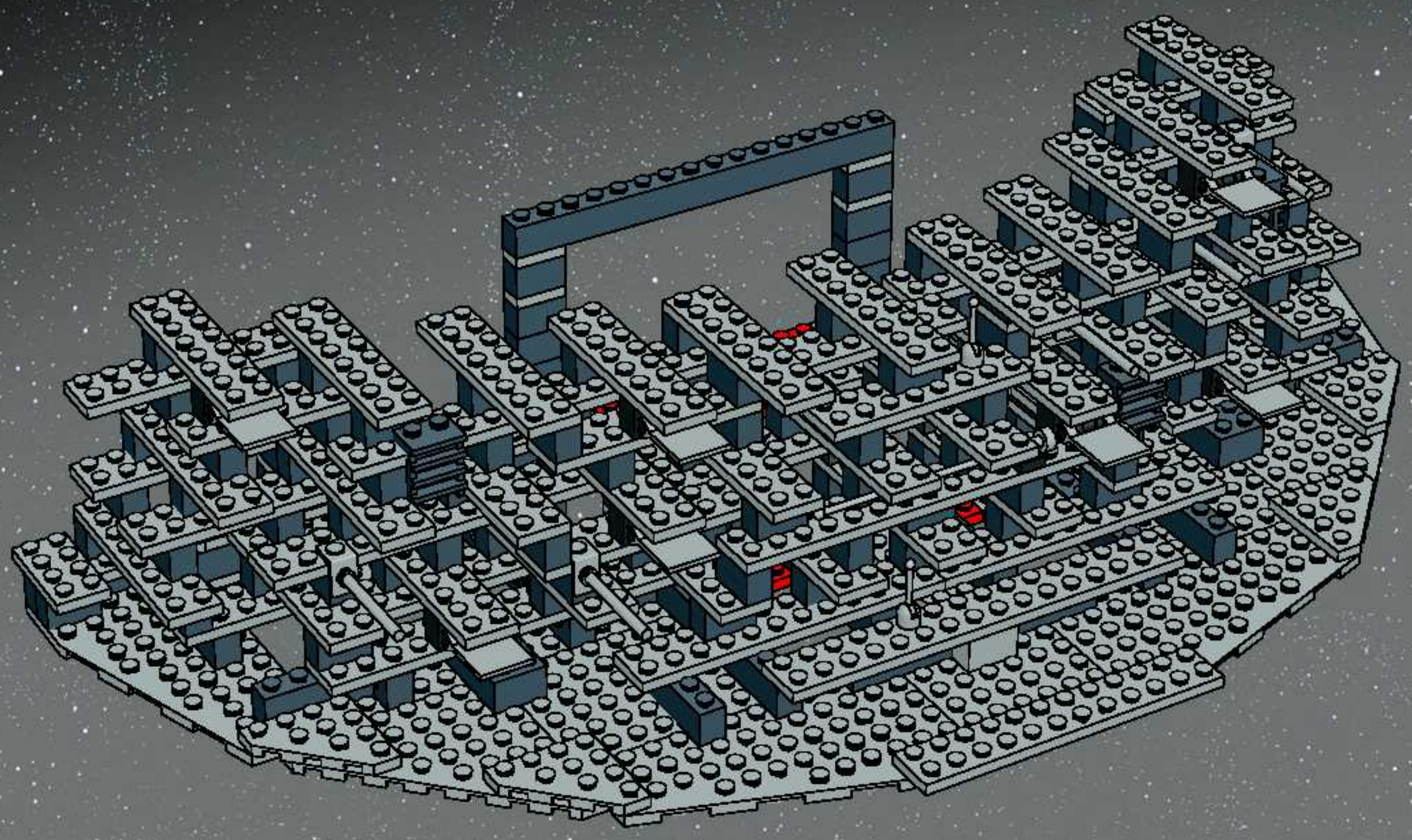

1x

1x

2x

2x

2x

2x

2x

18

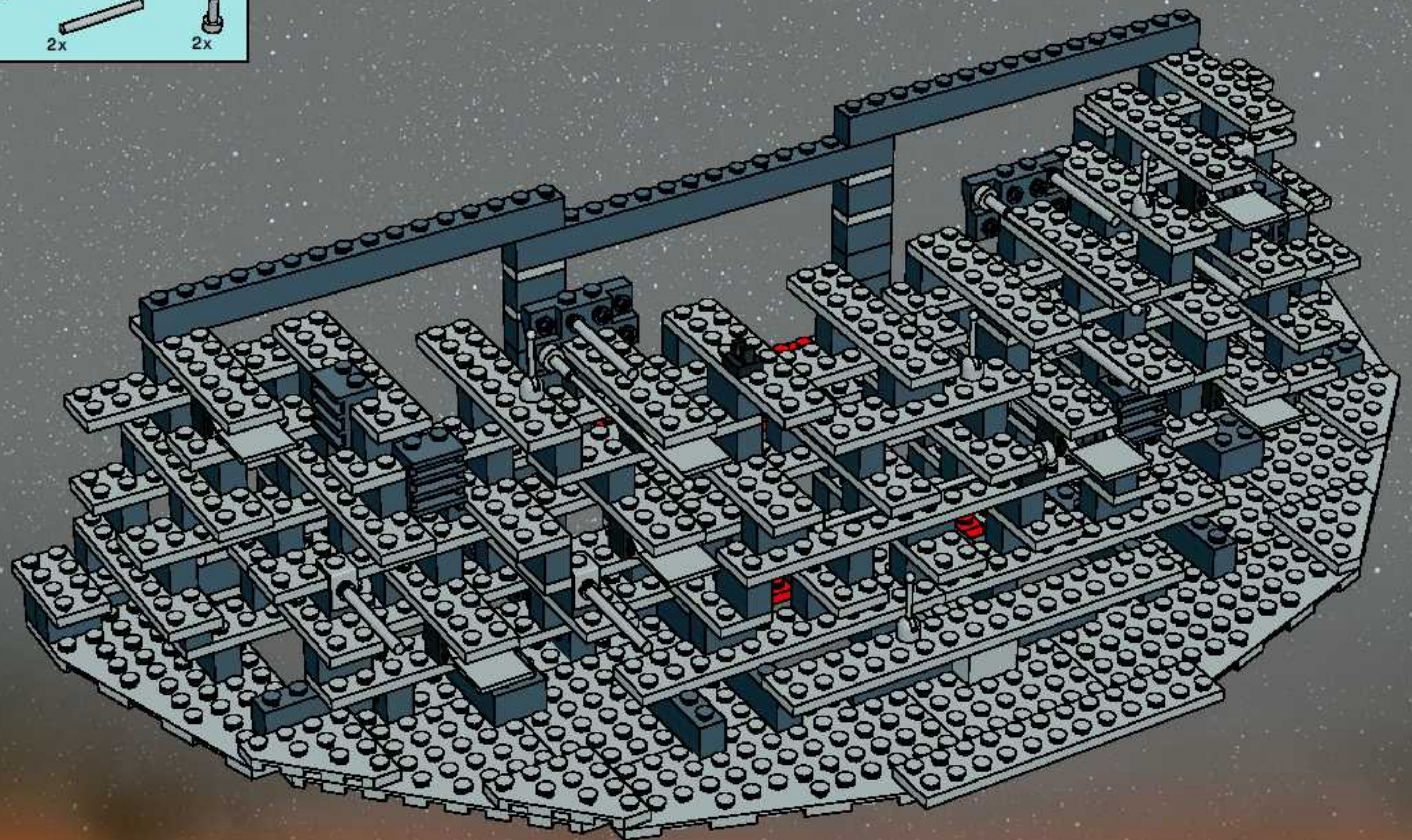



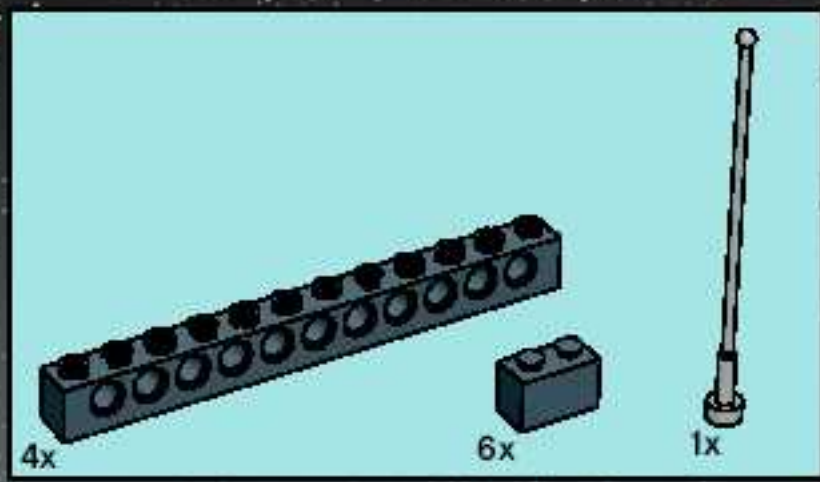

19

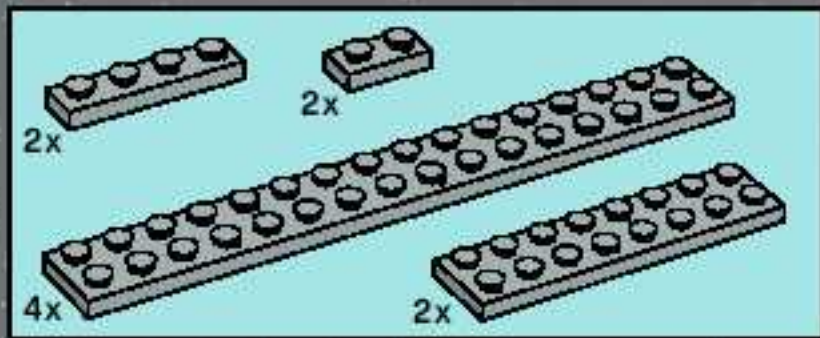
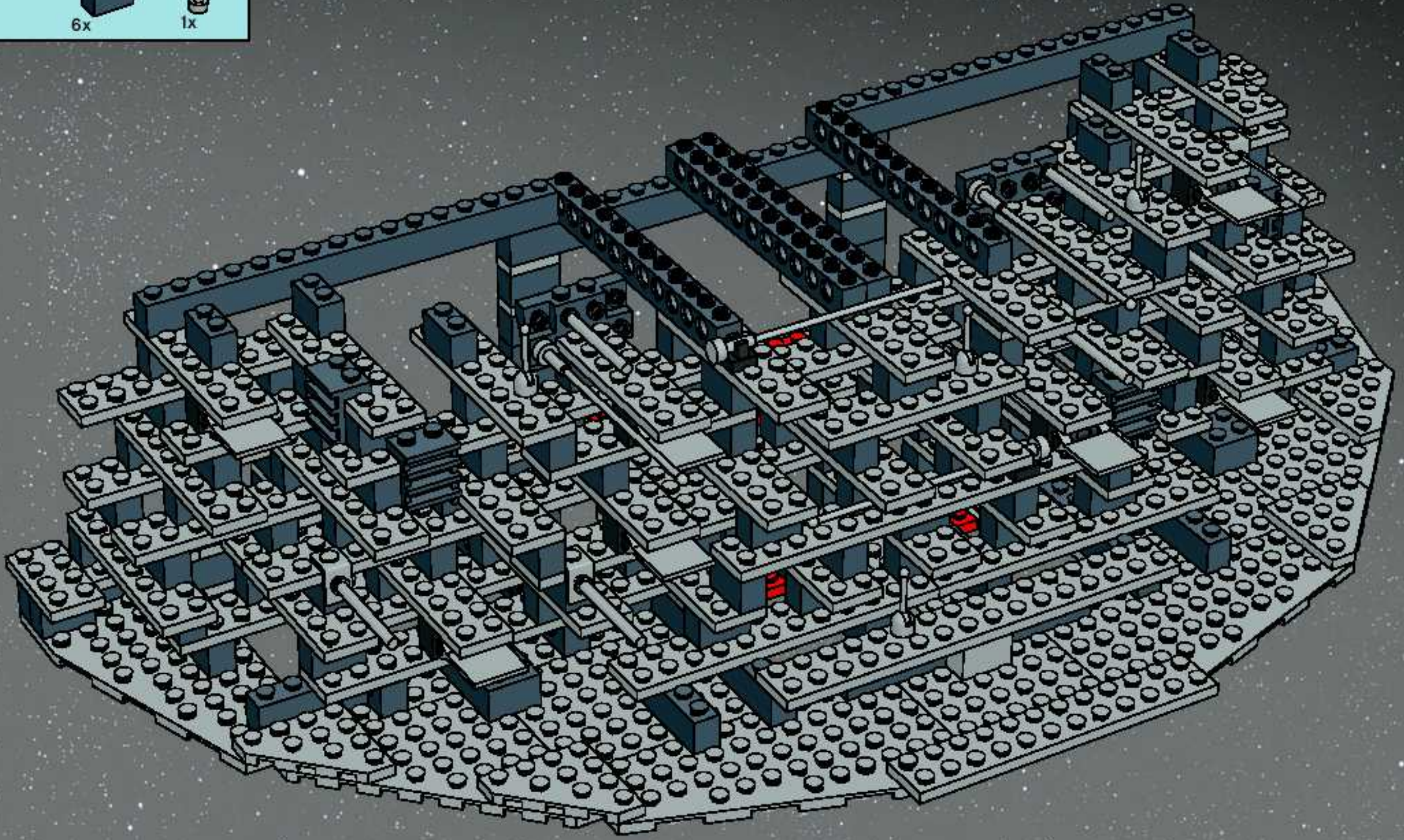

20

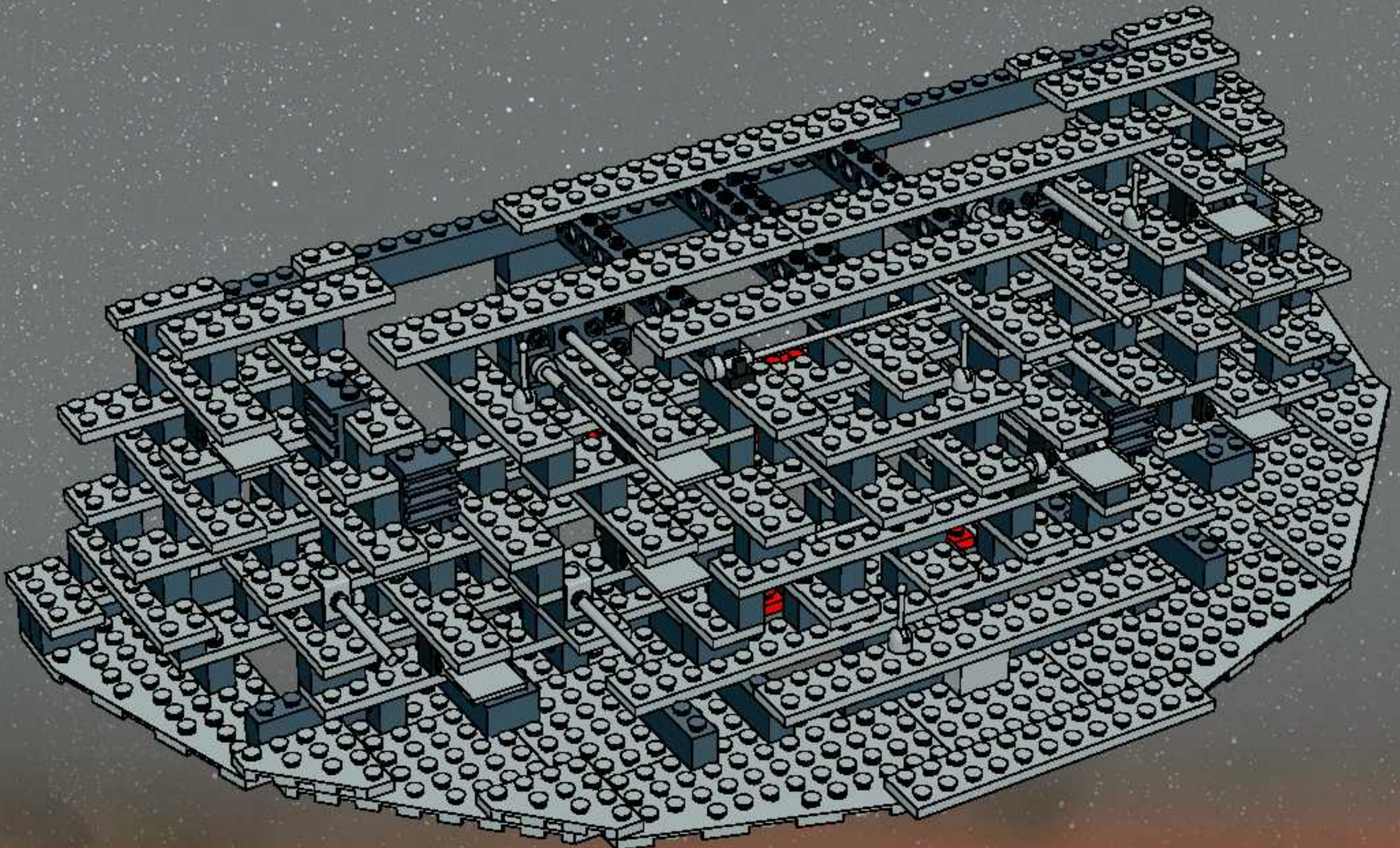



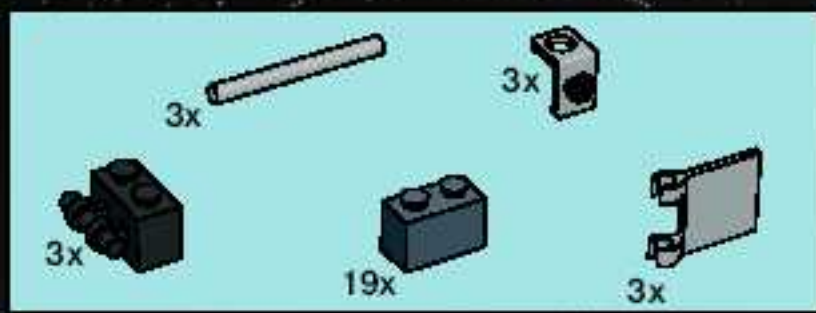

21

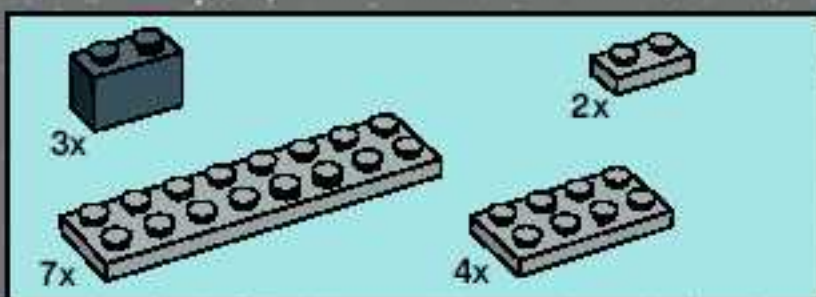
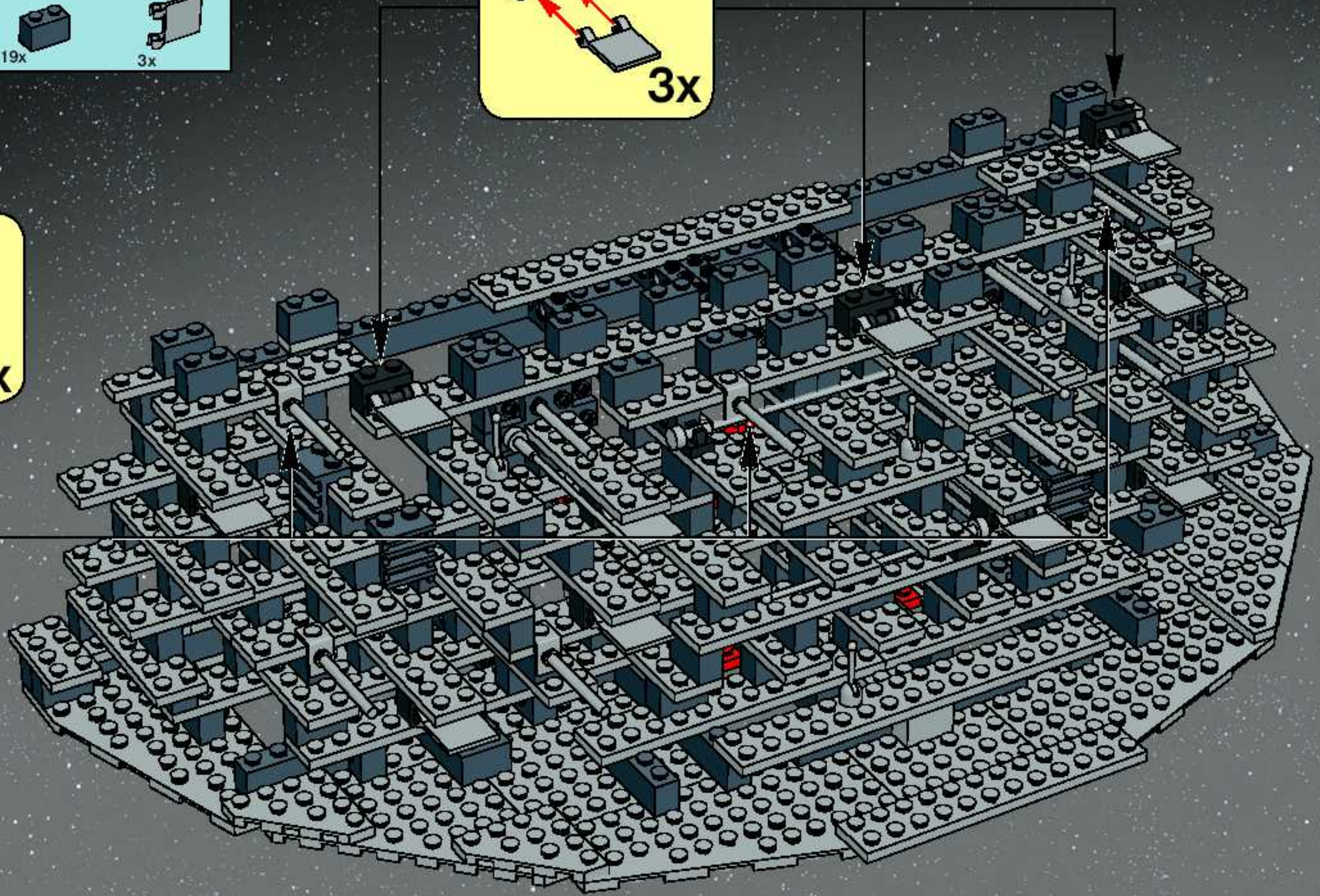
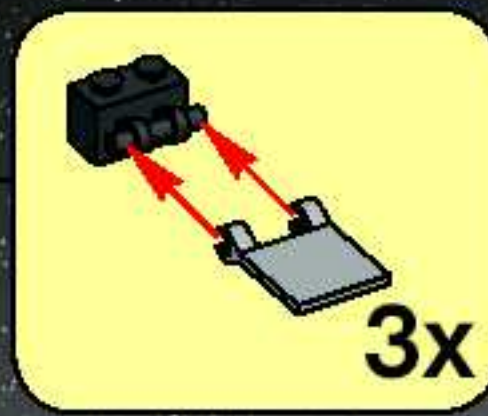

22

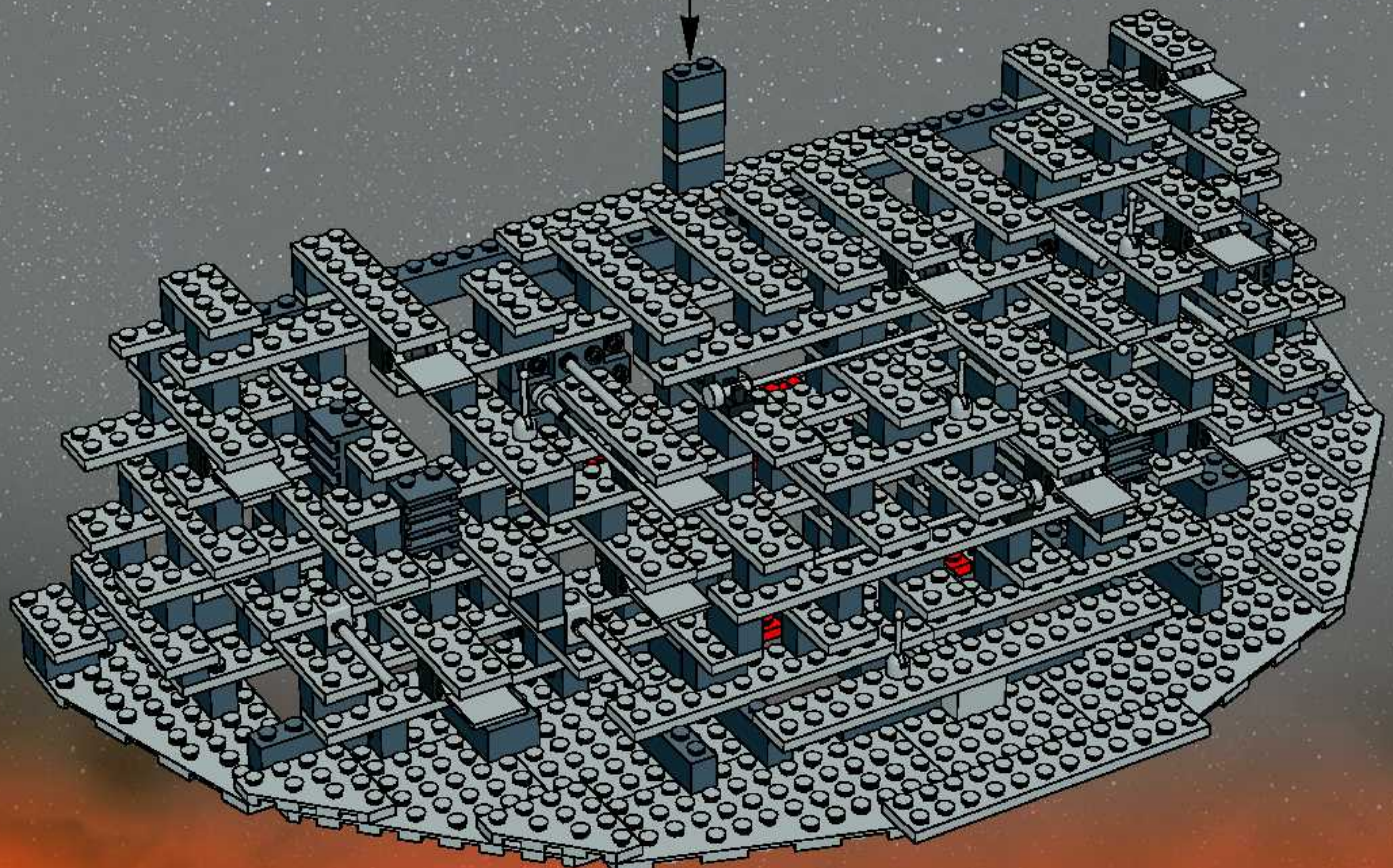
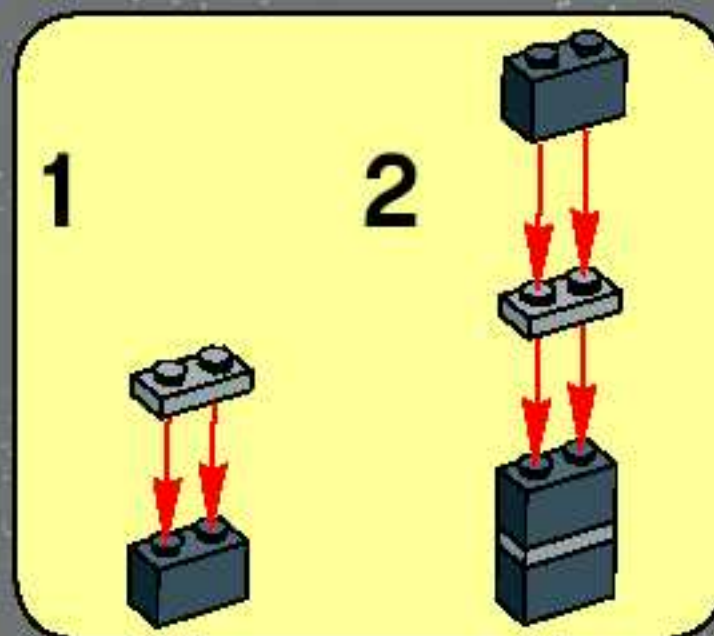







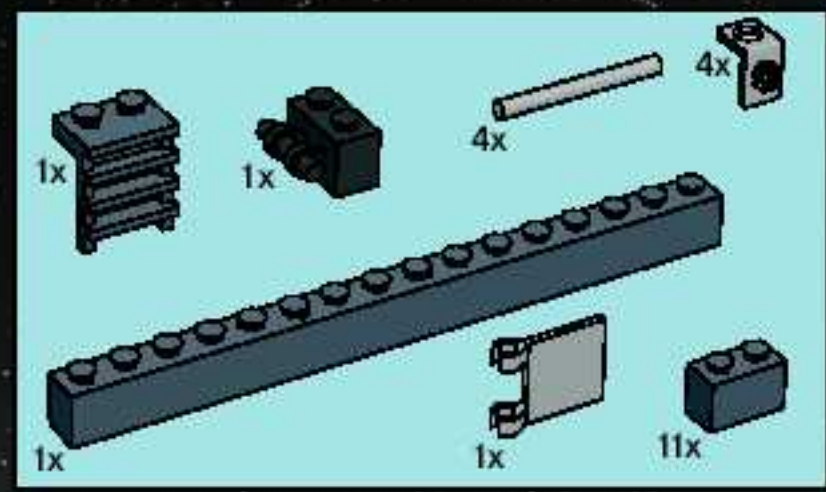

25

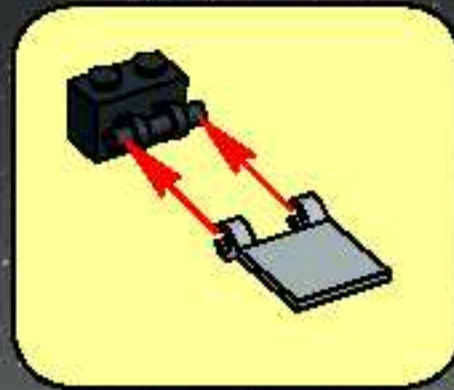

4x

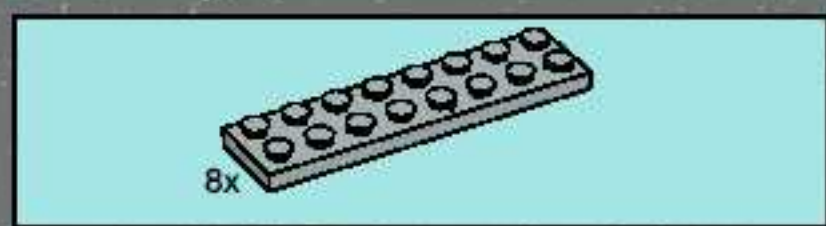
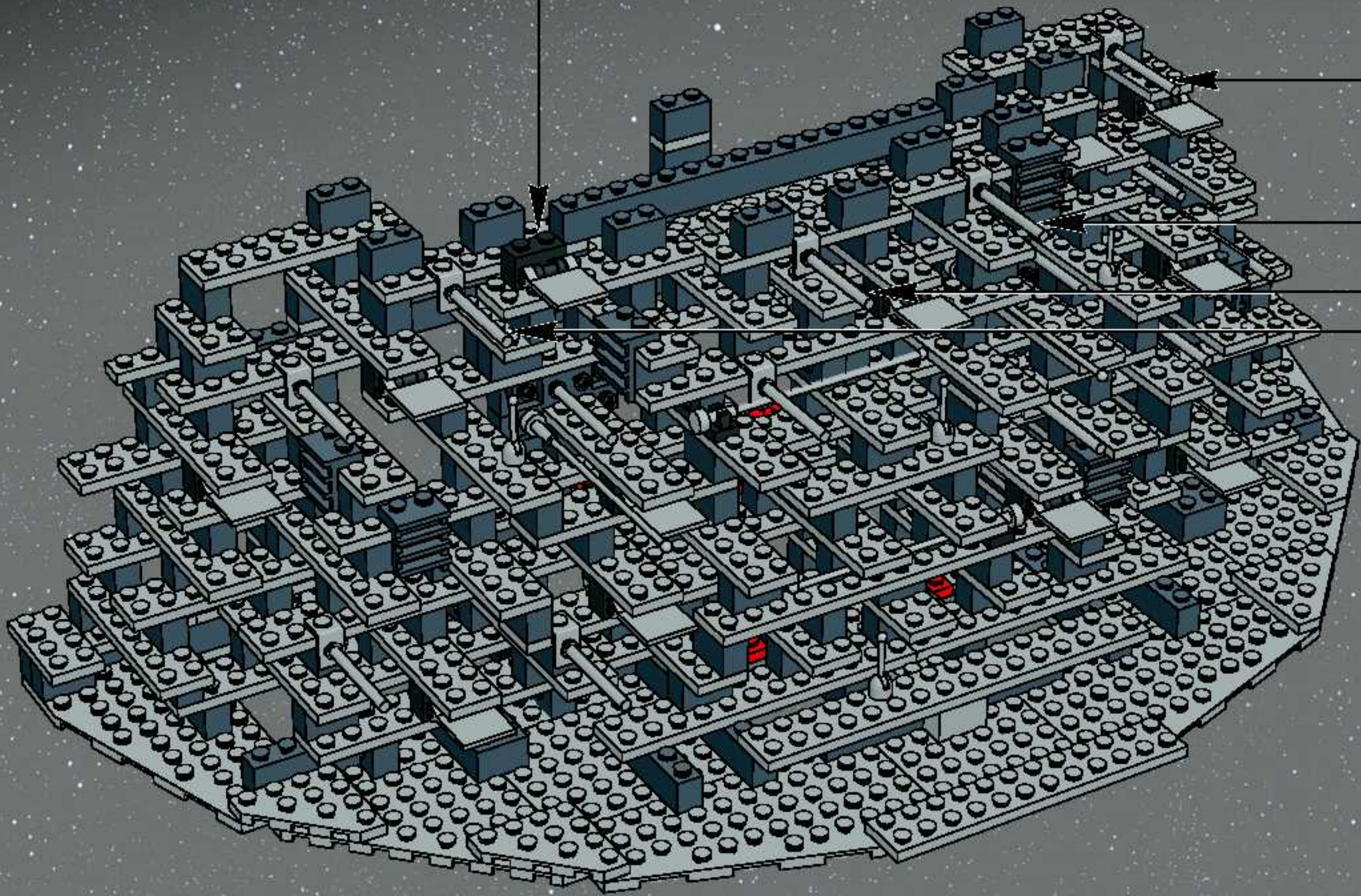

26

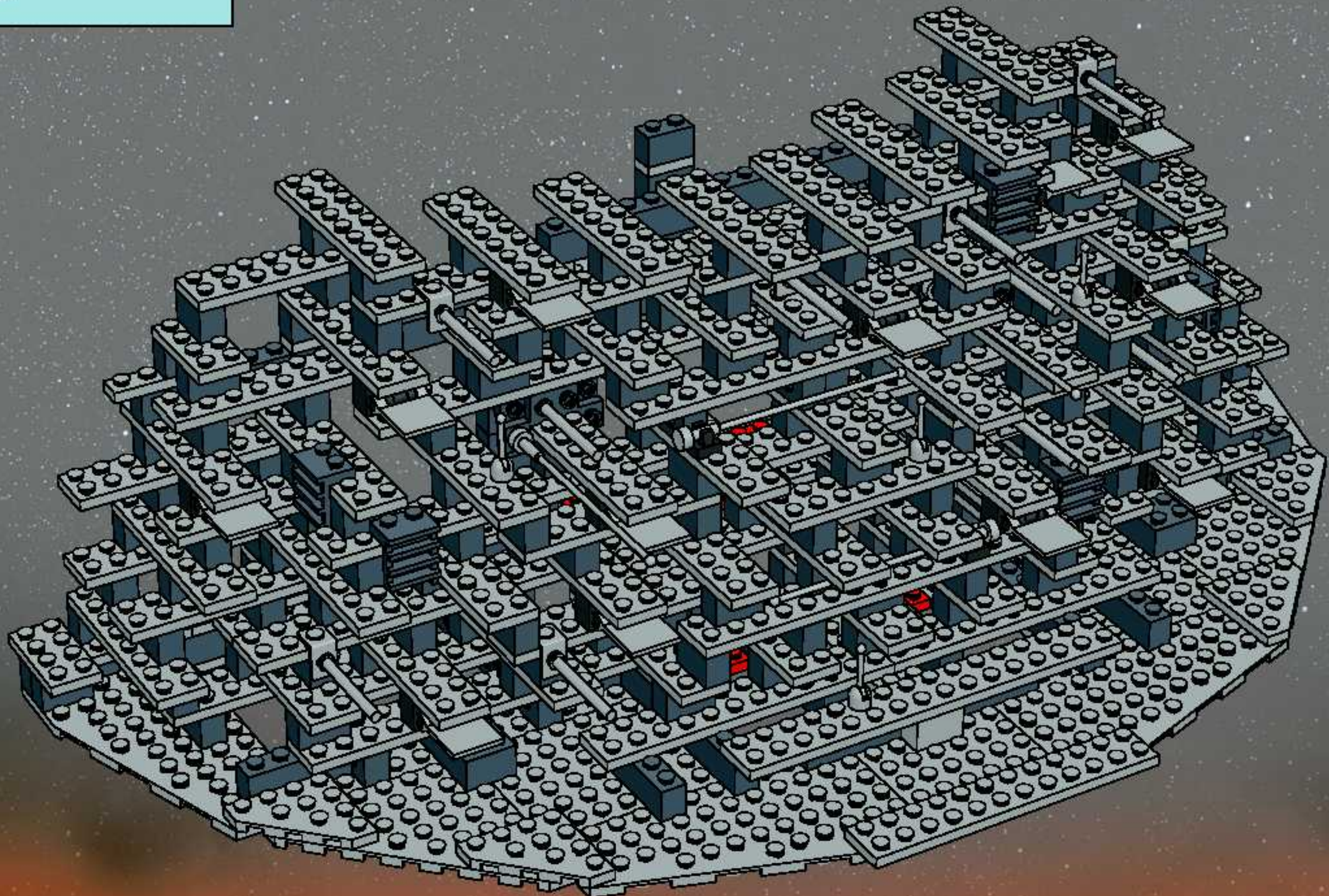



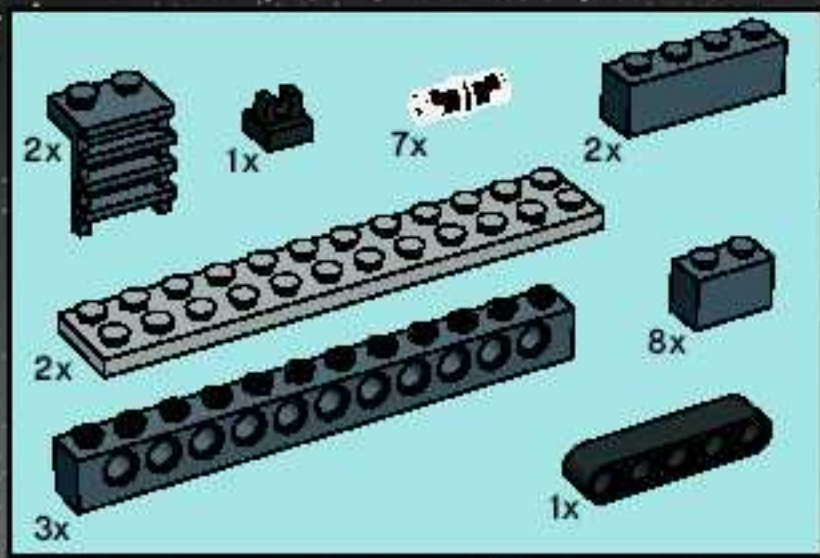

27

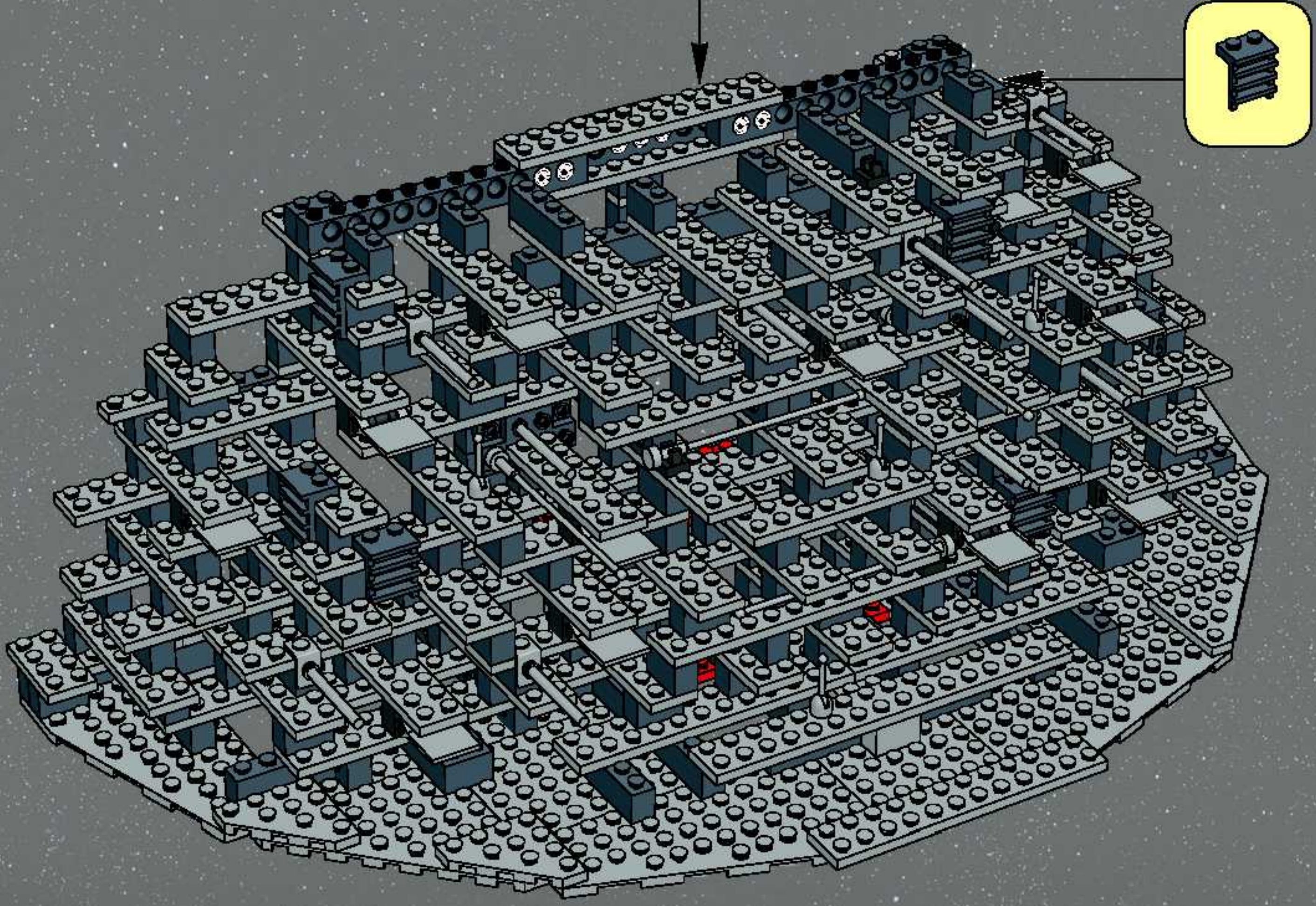
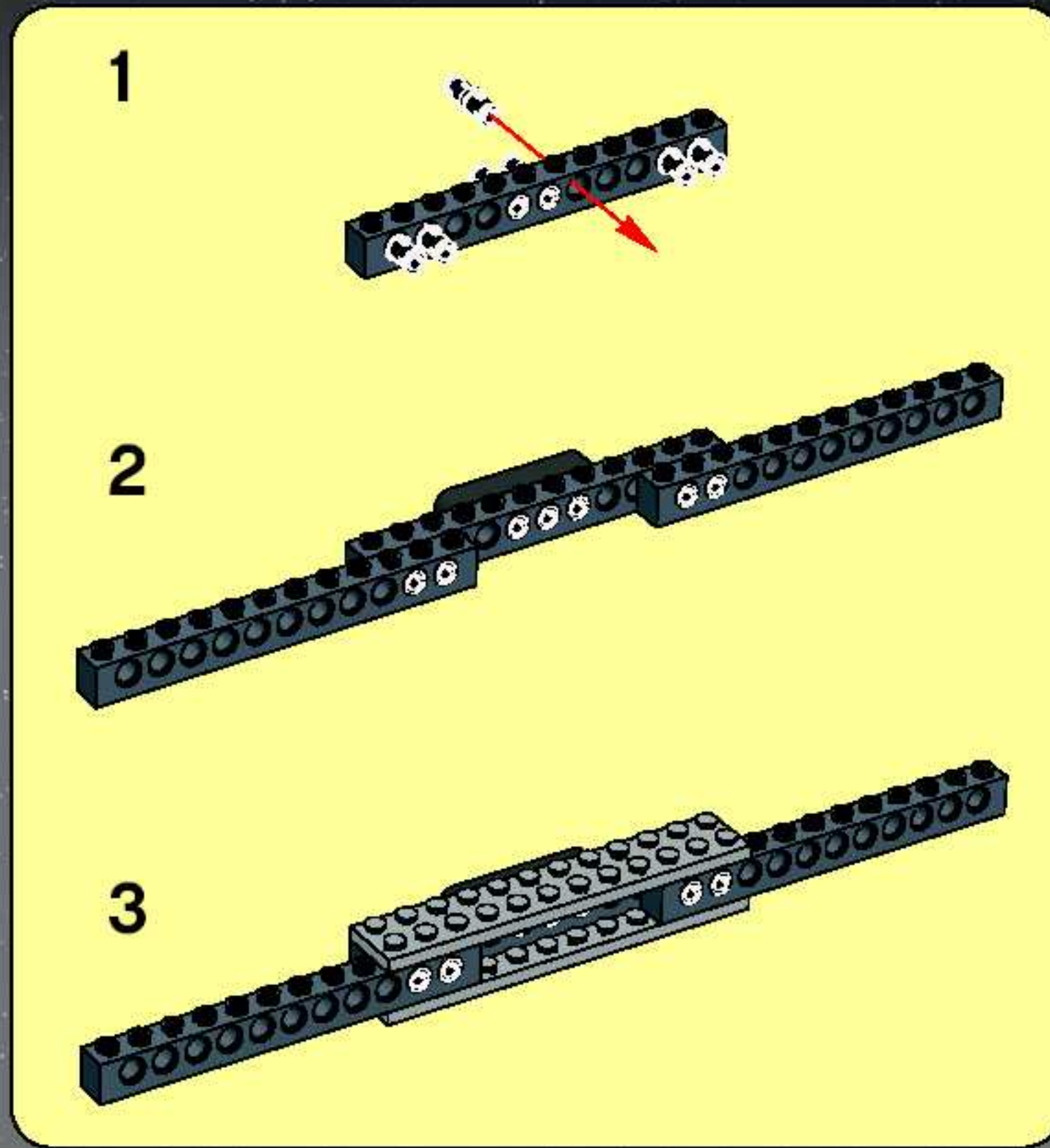



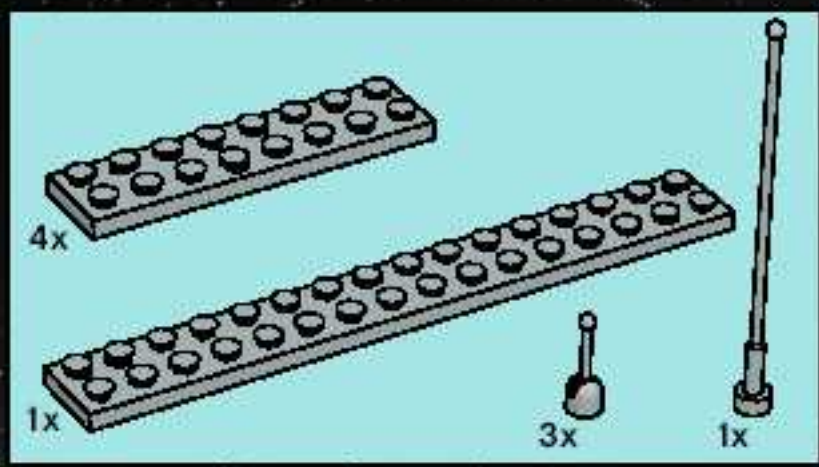

28

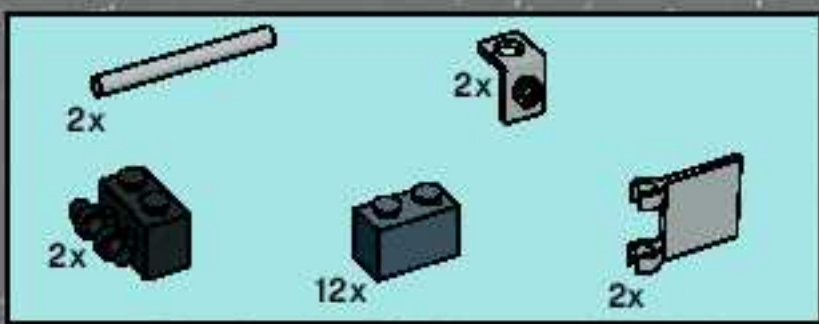
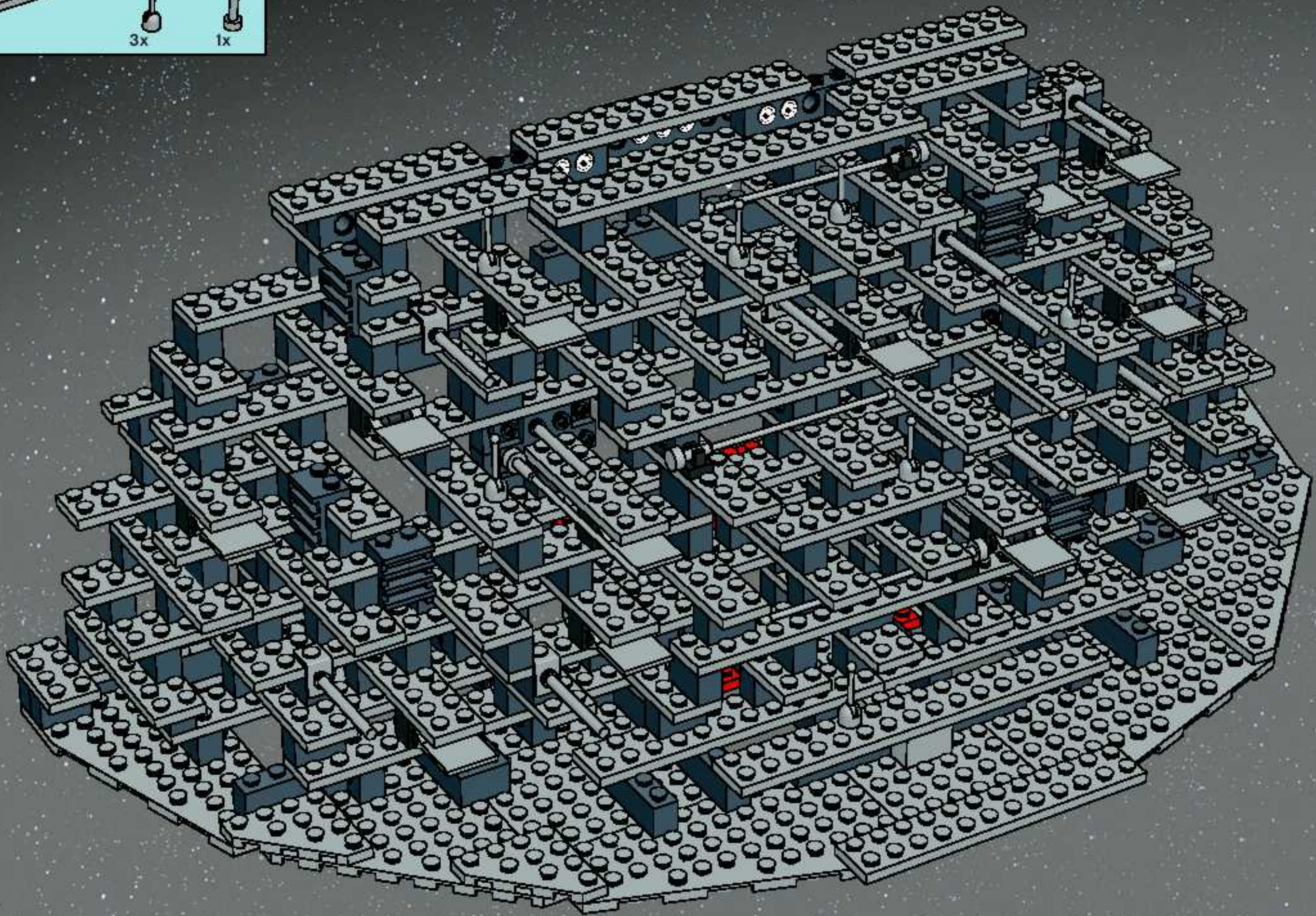

29

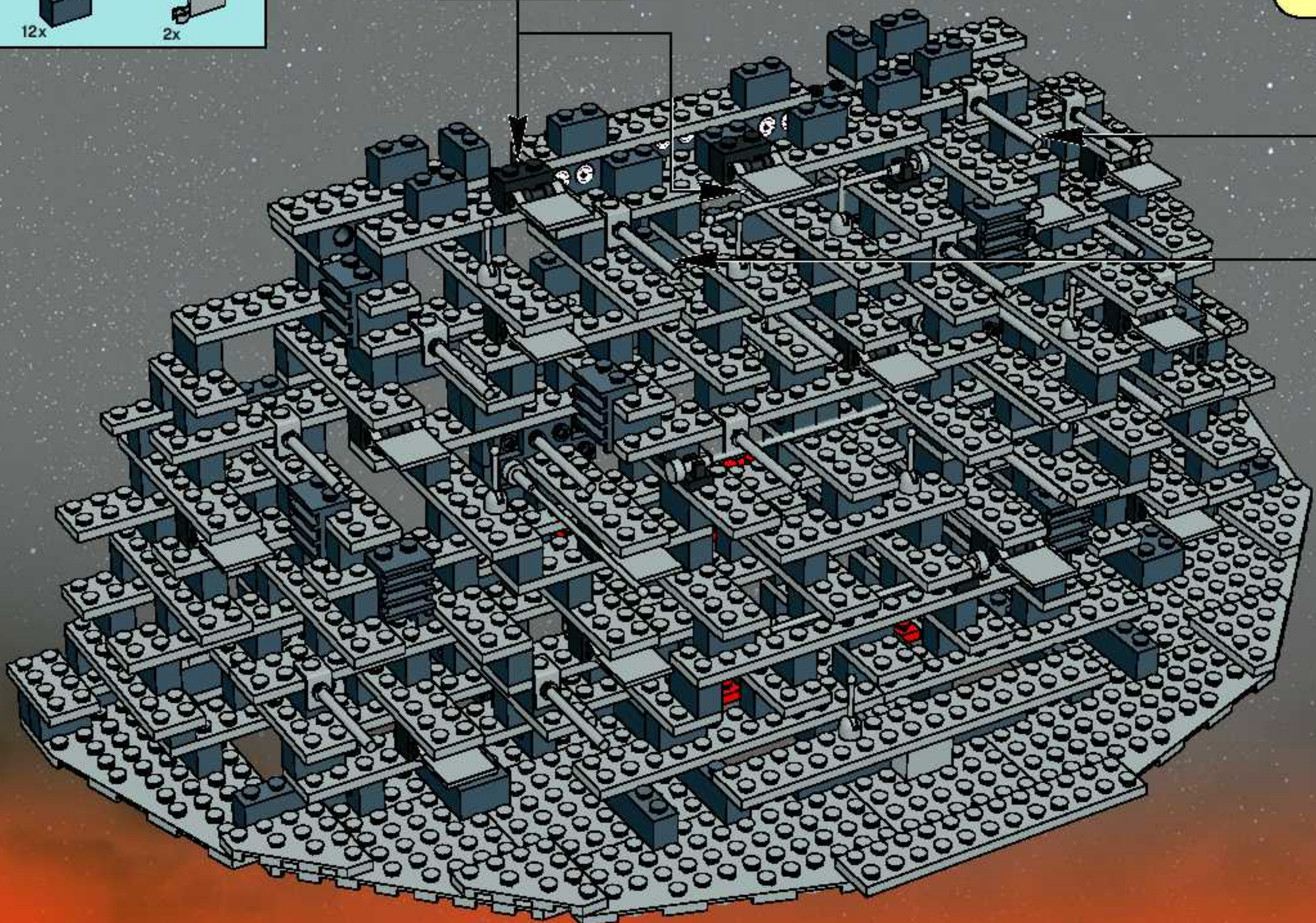
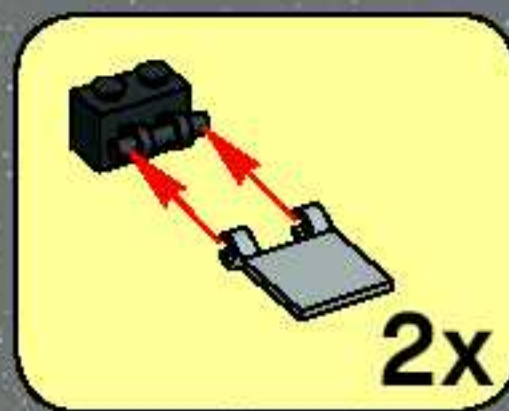





30

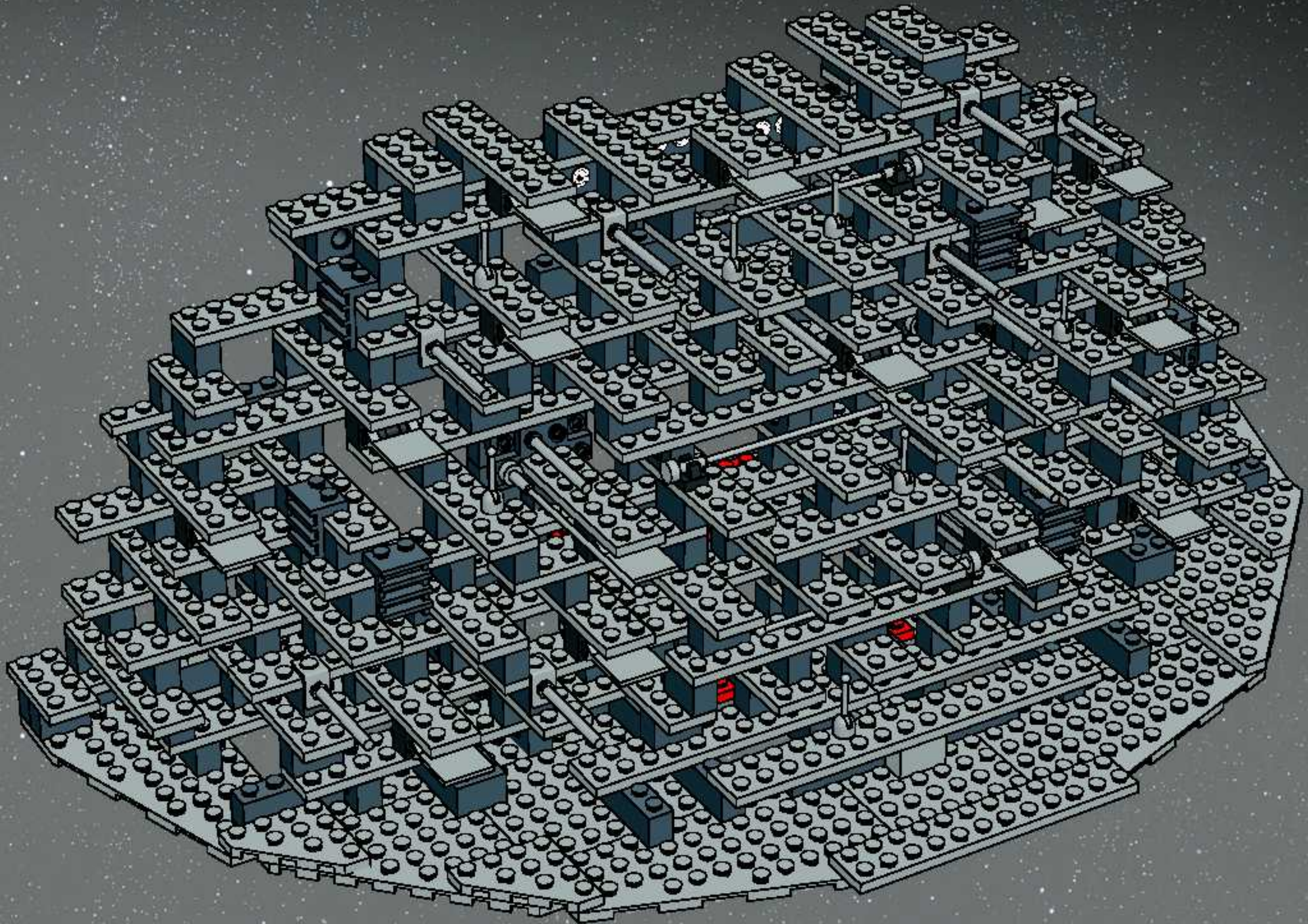

31

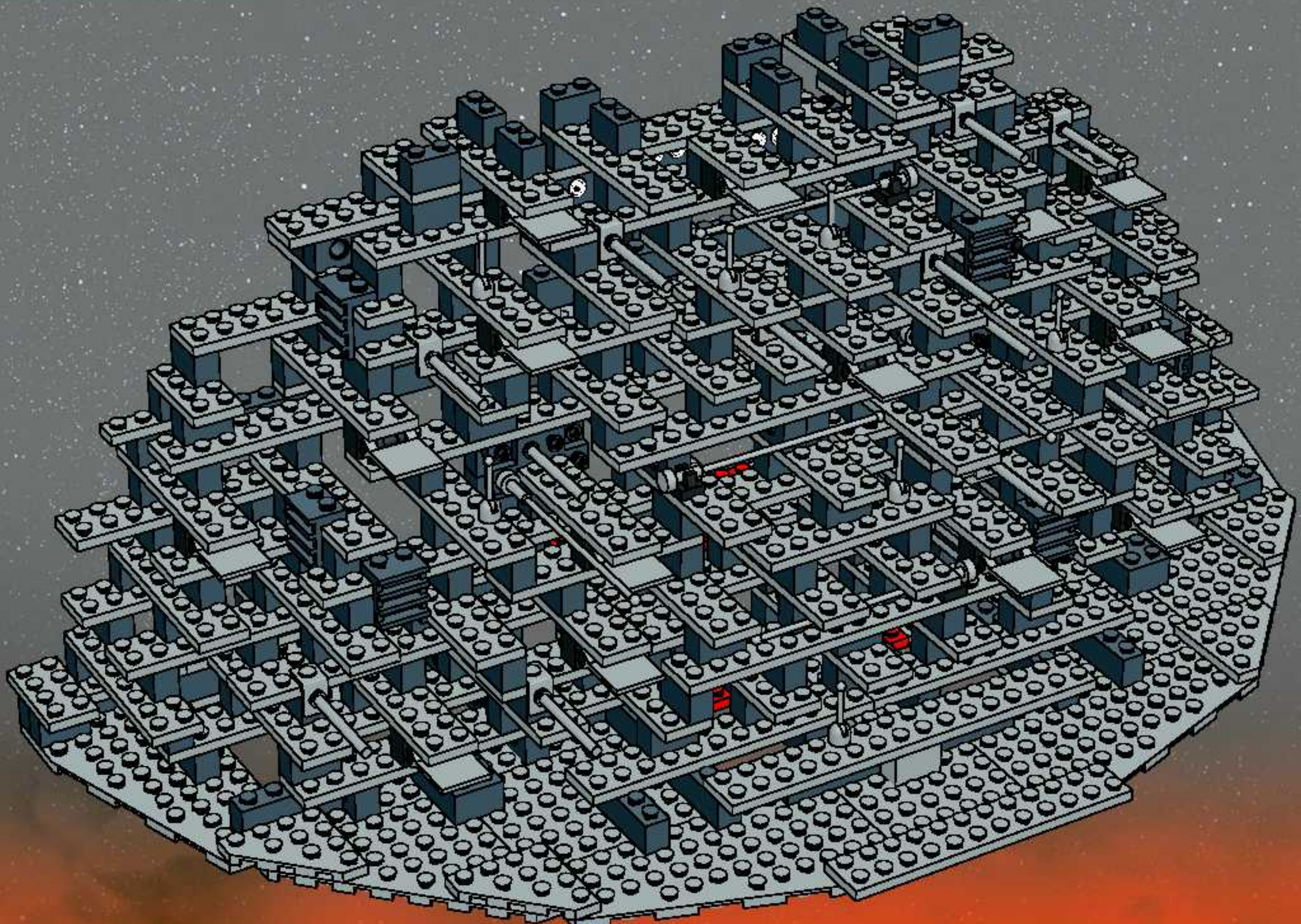



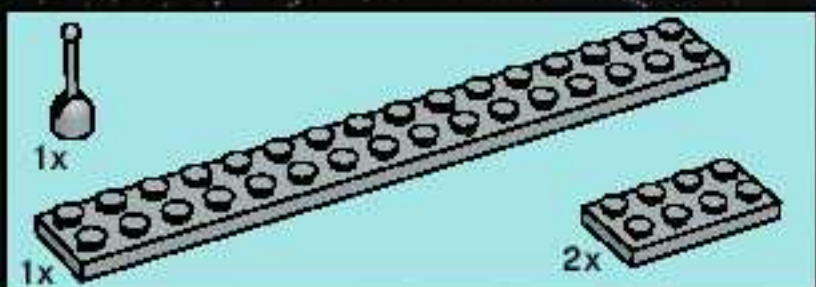

32

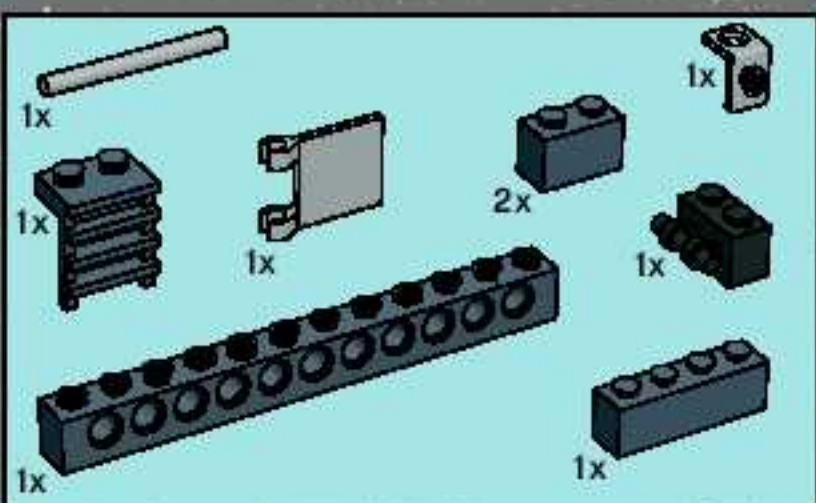
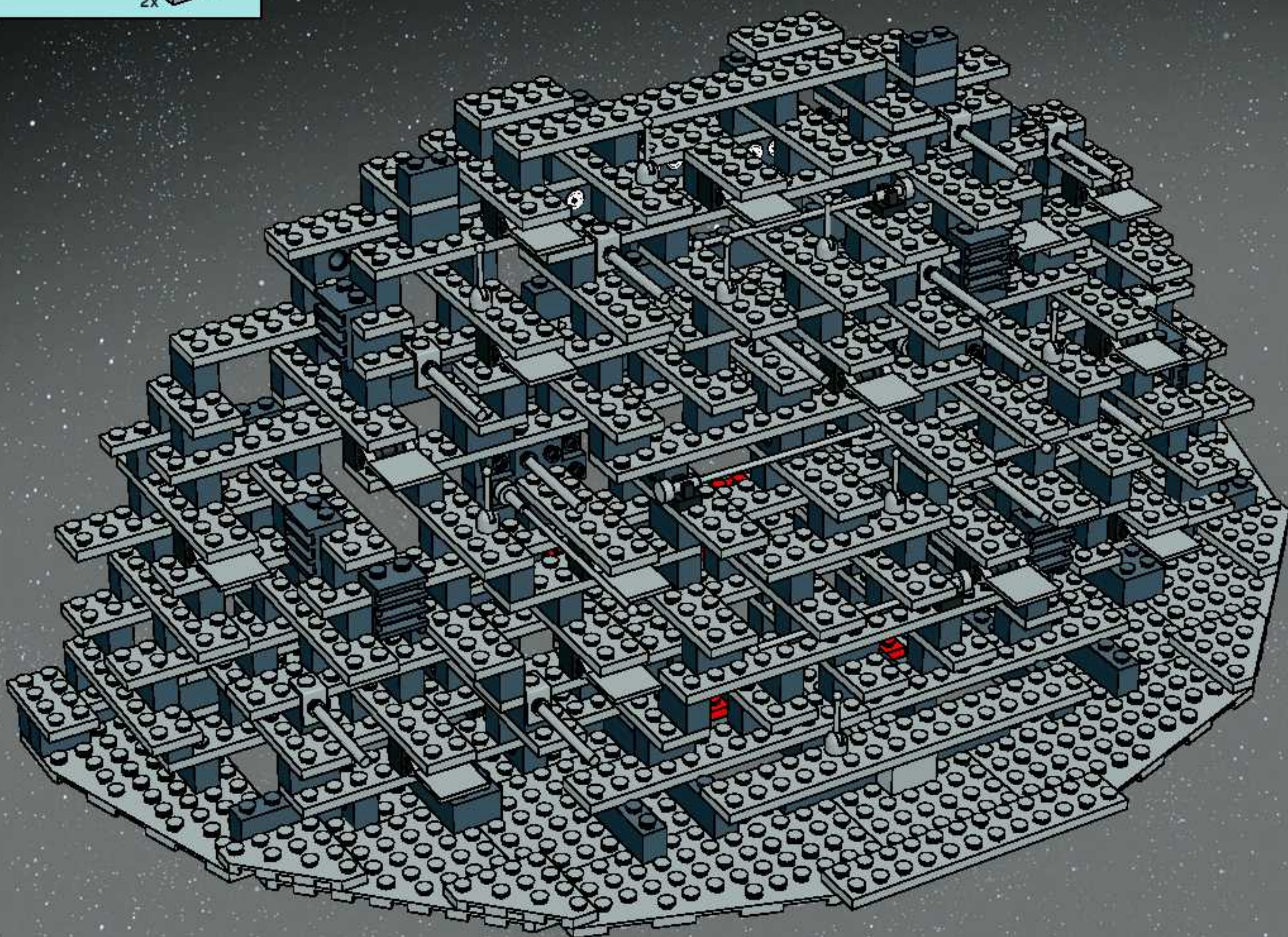

33

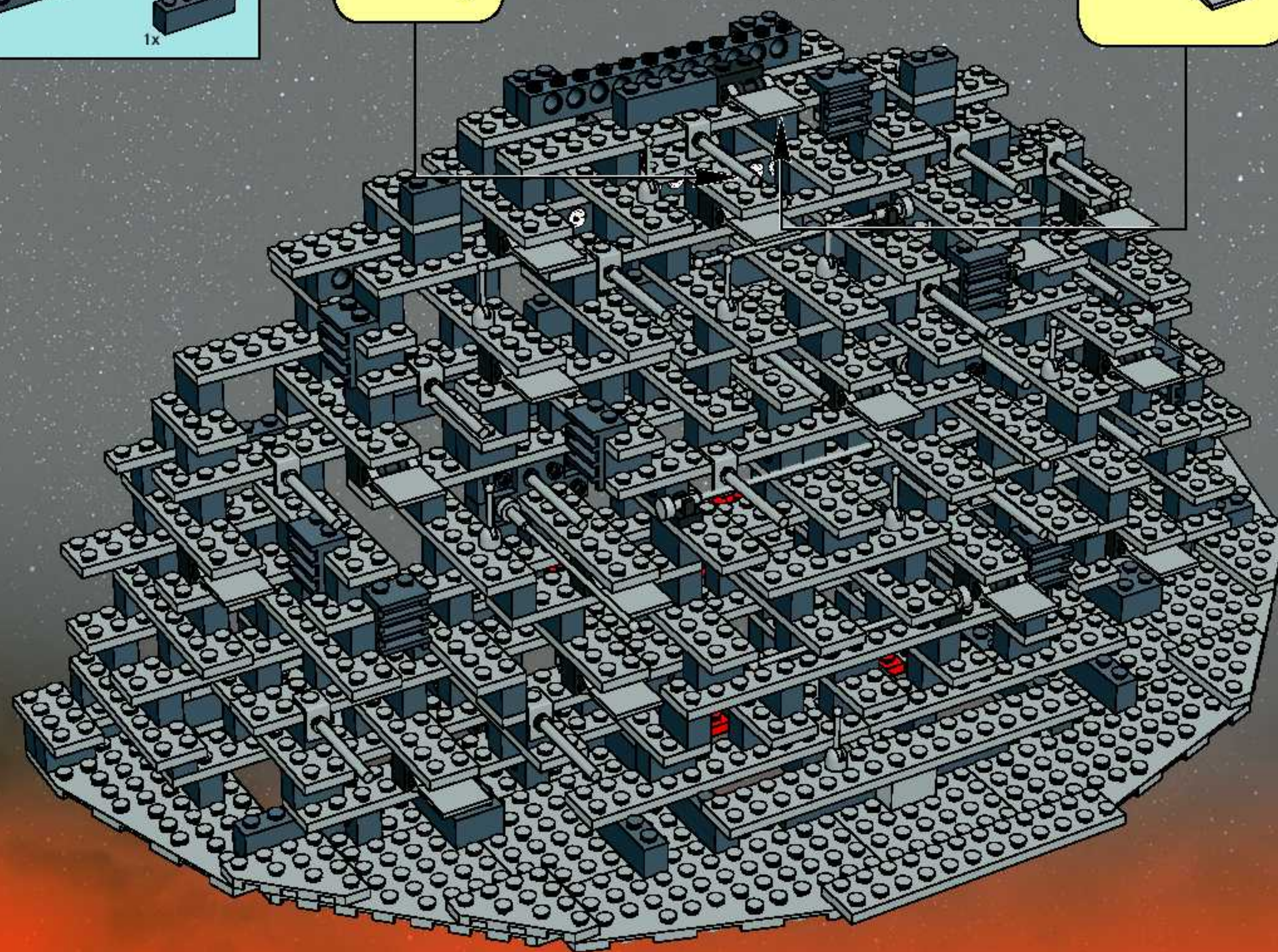
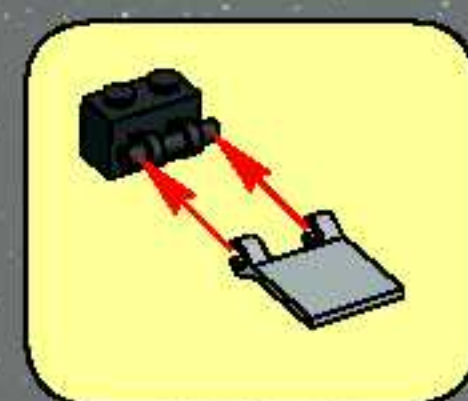



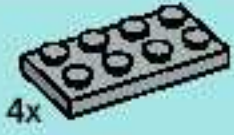

4x

34

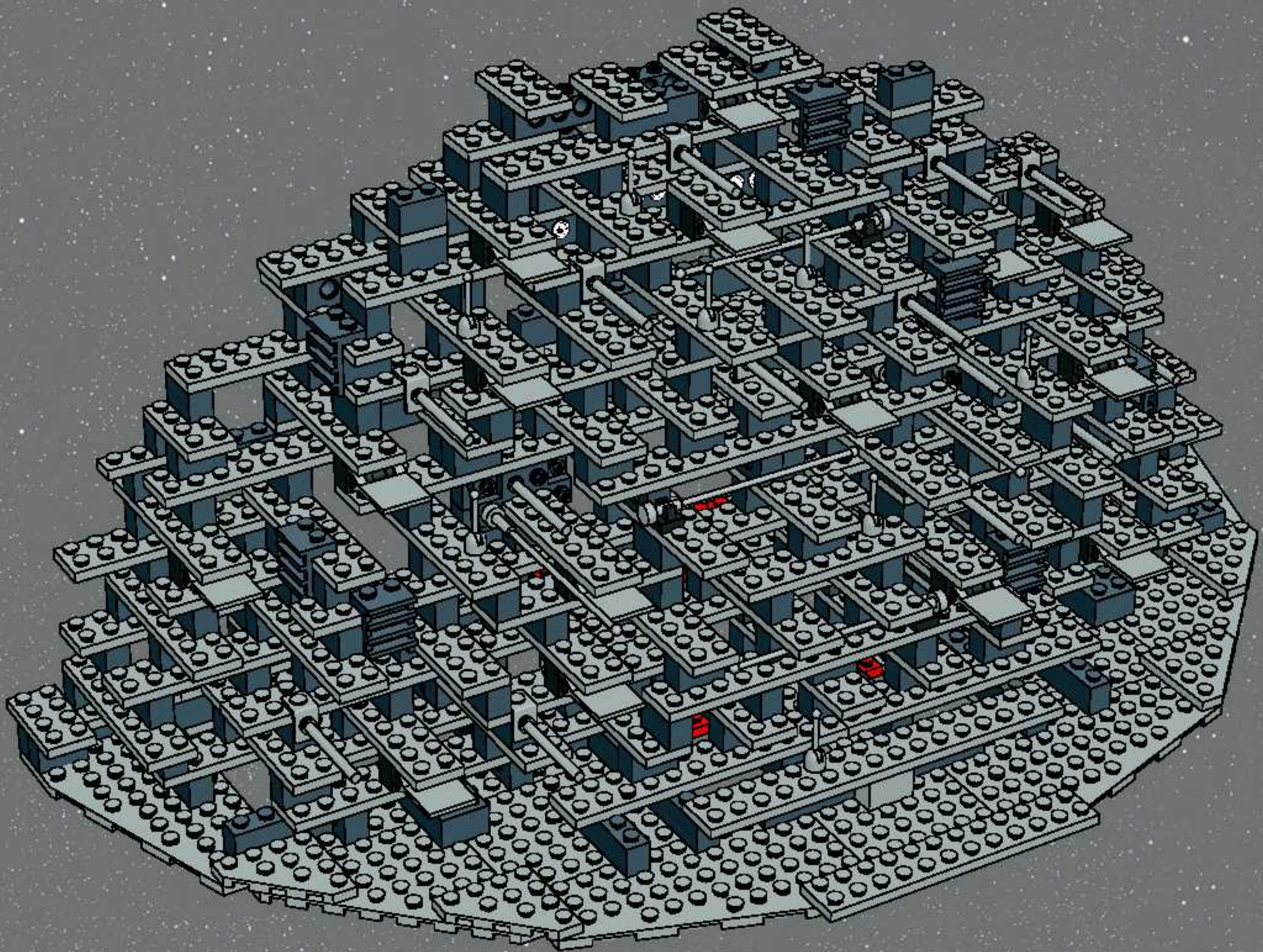

2x



23

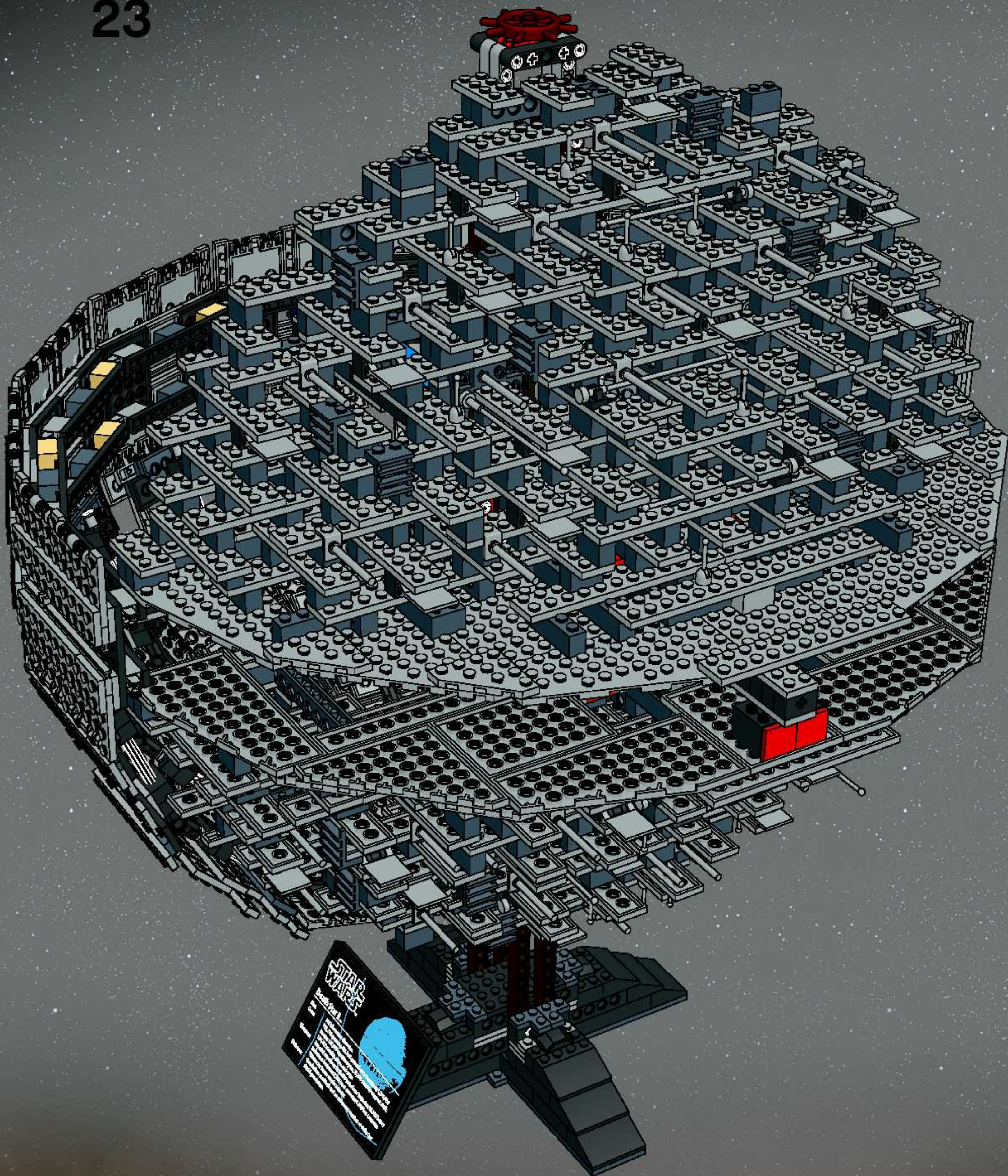



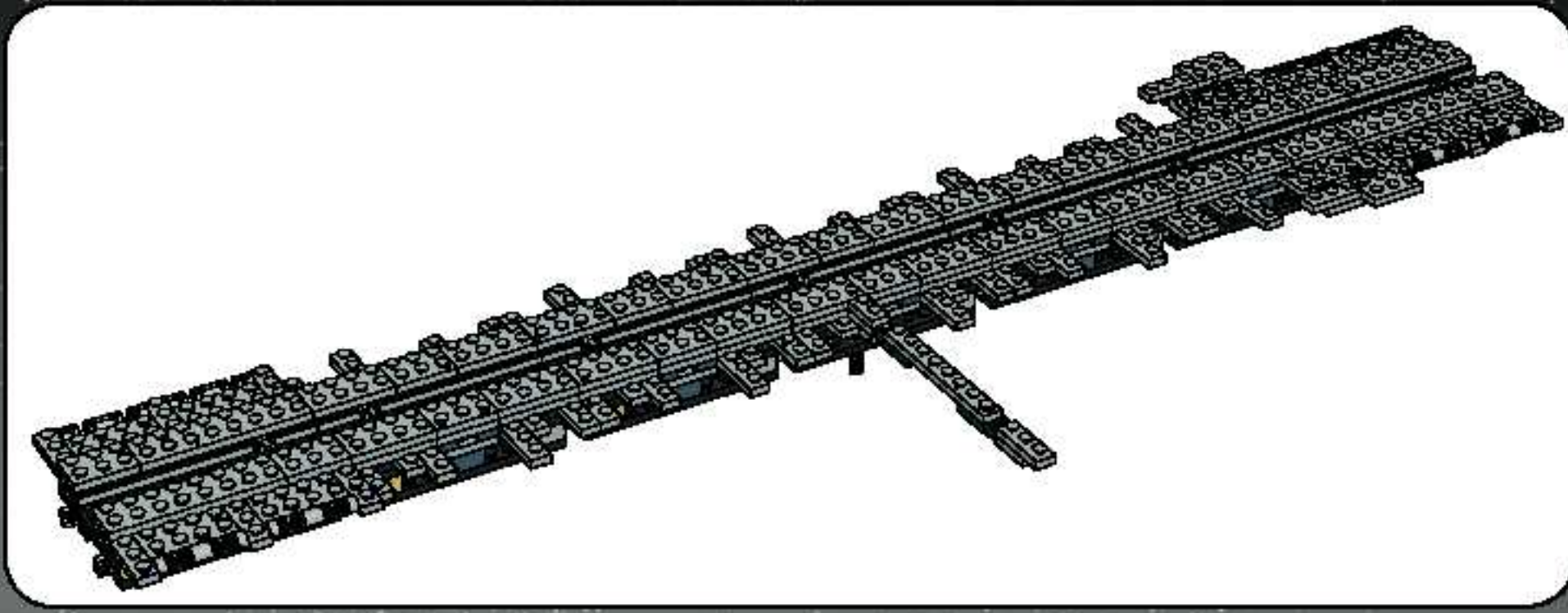

1

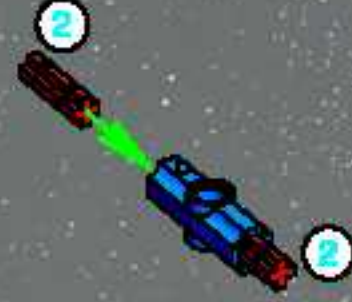

2



3



4







5

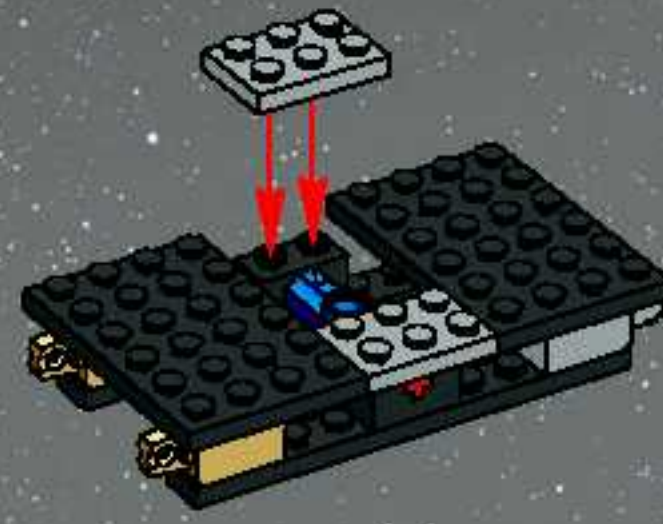

6

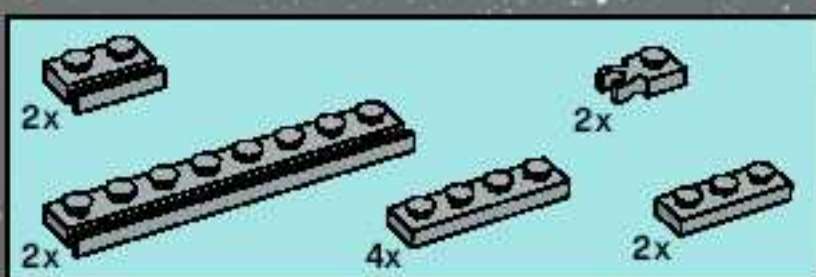

7





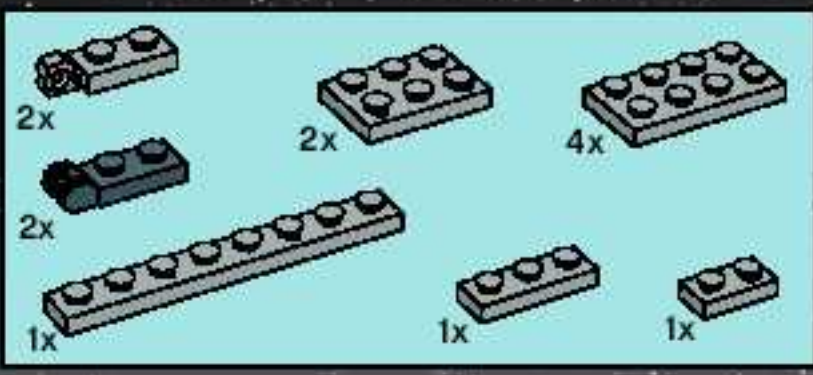

8

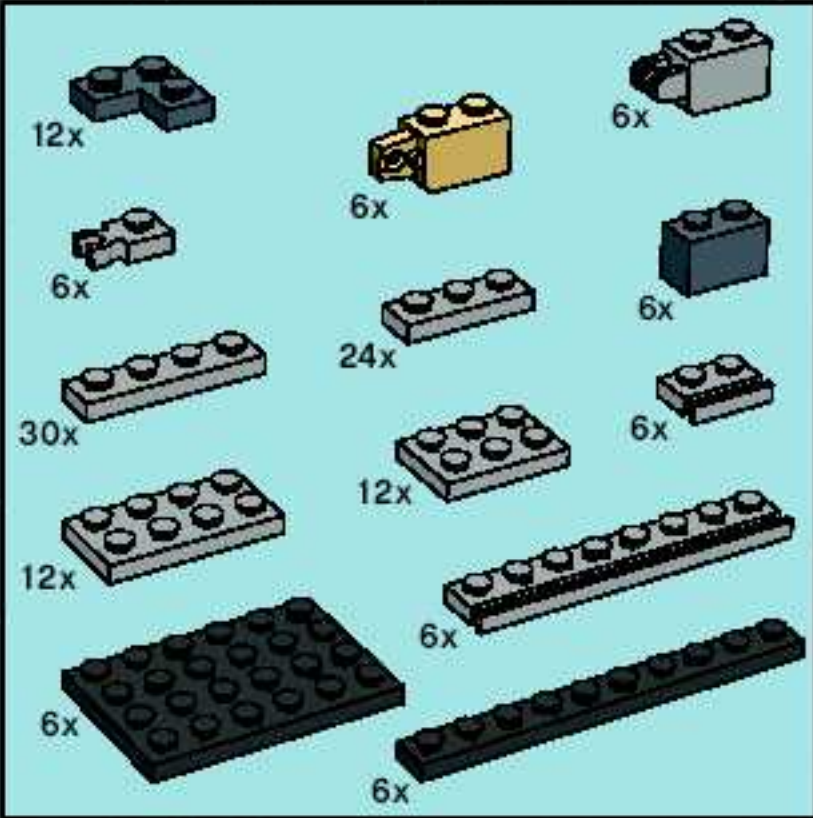
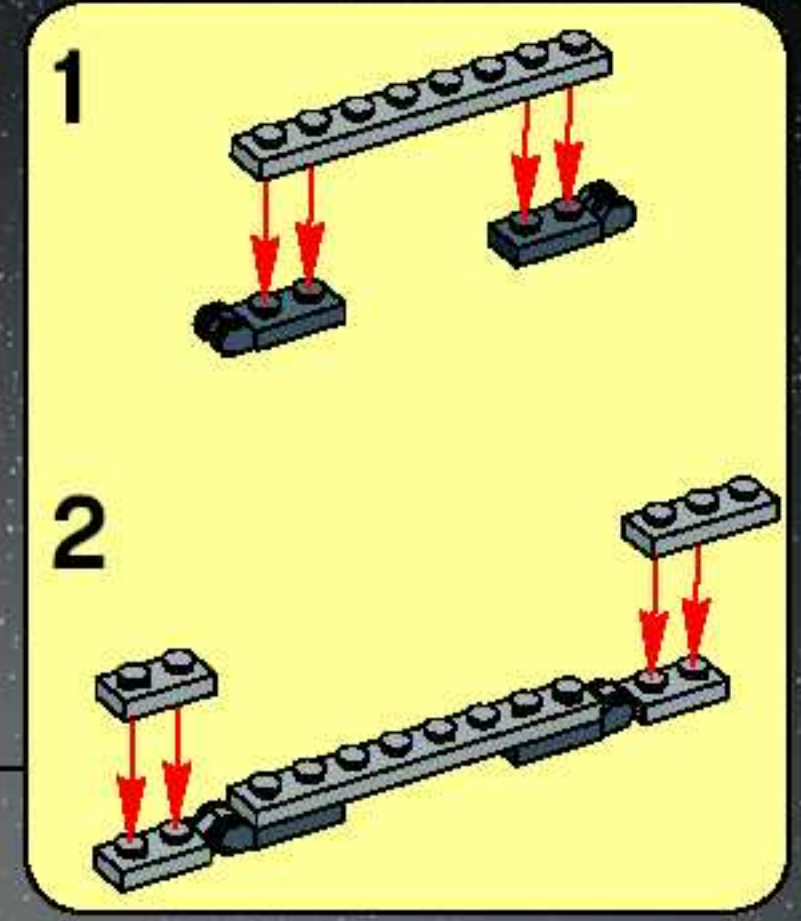
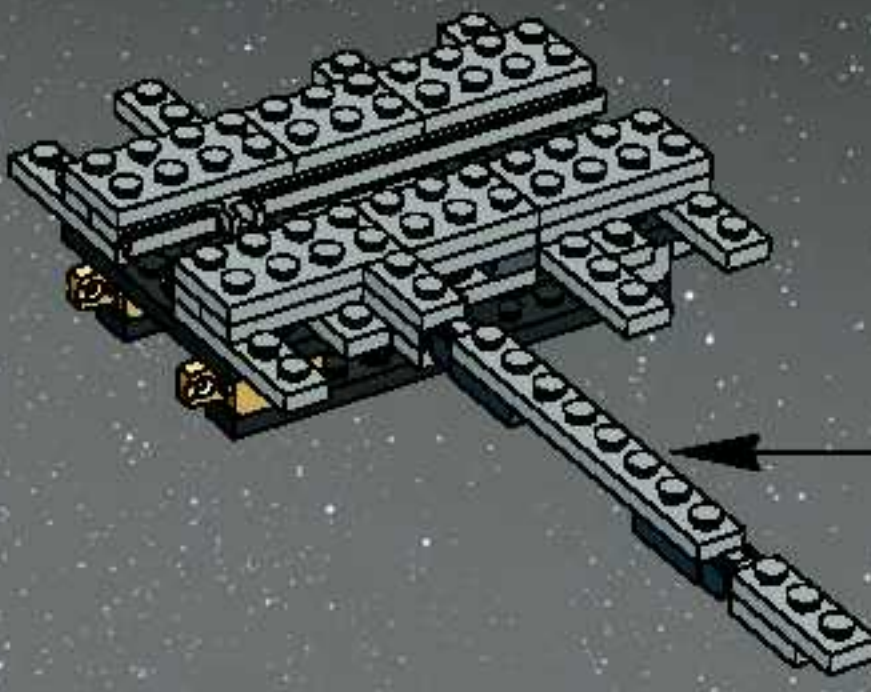

9

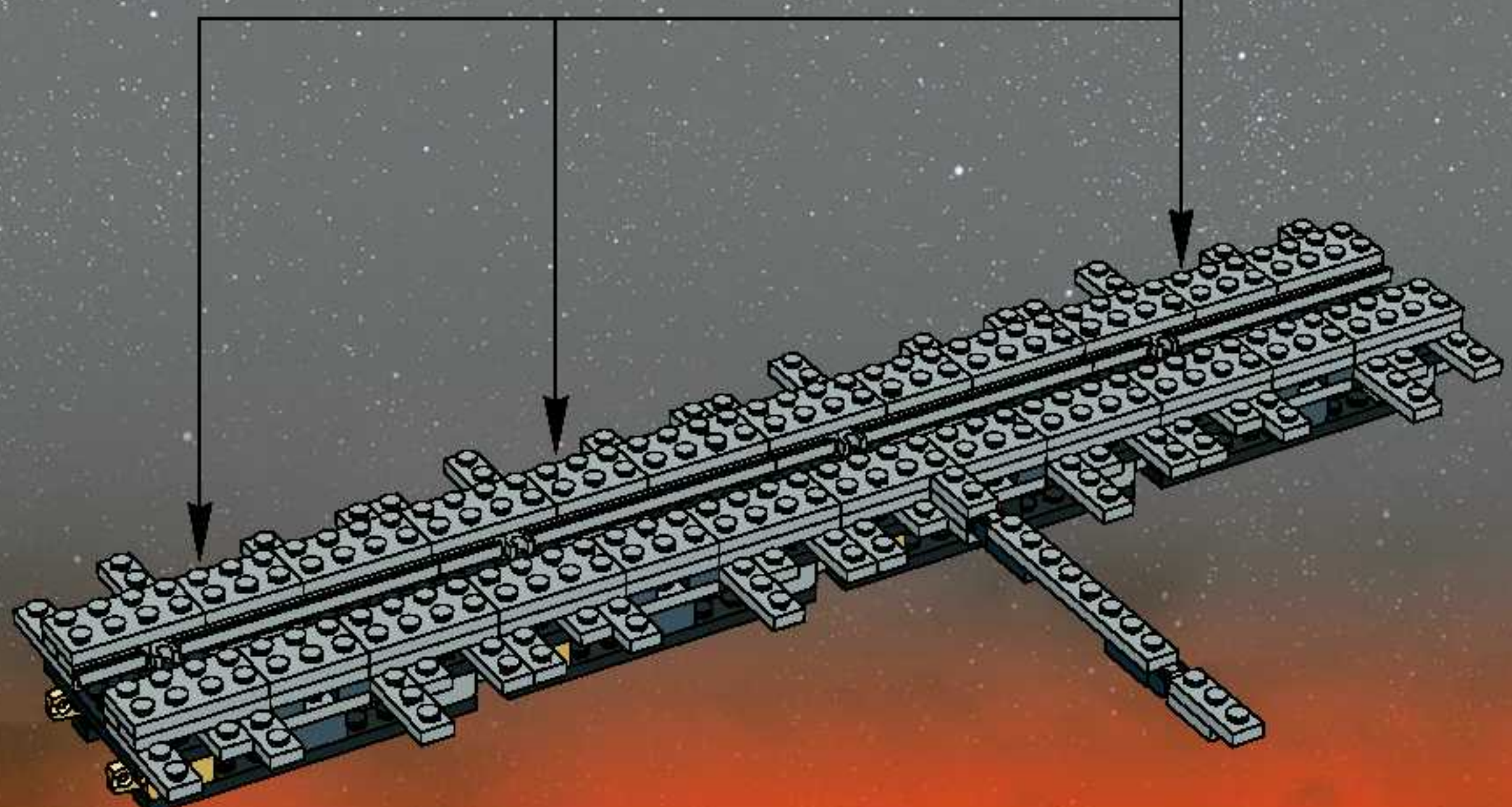
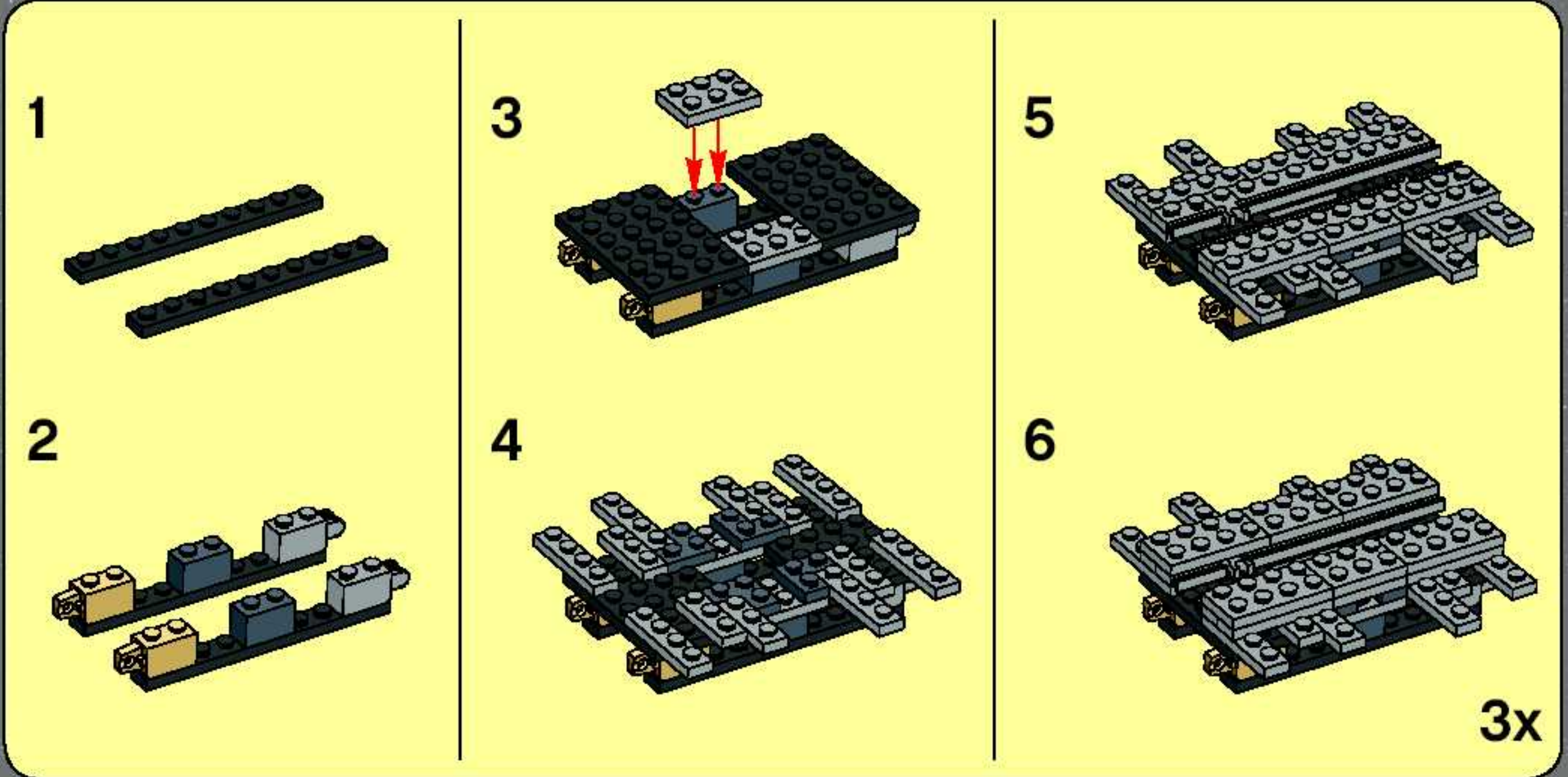



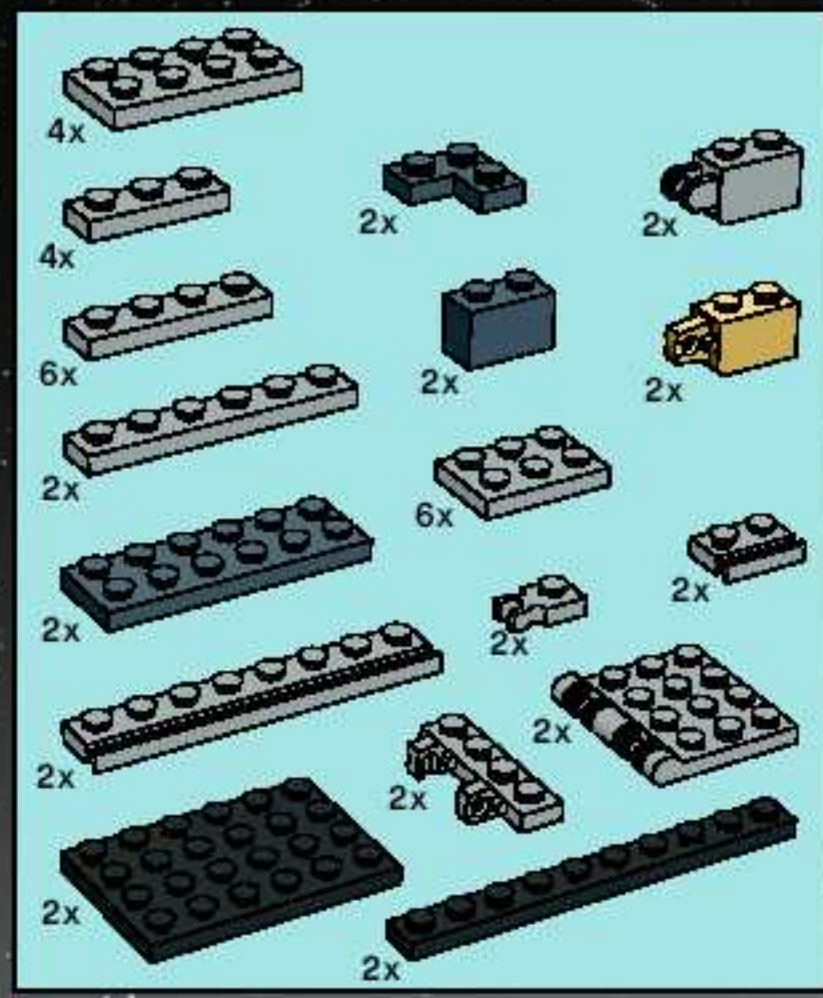

10

1

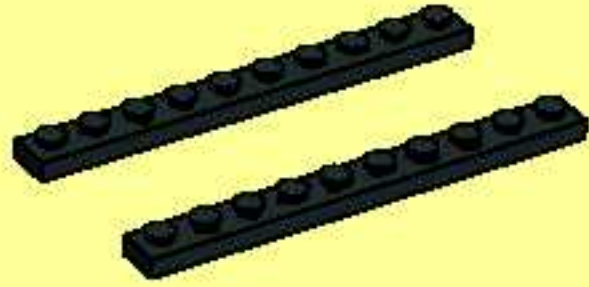

2

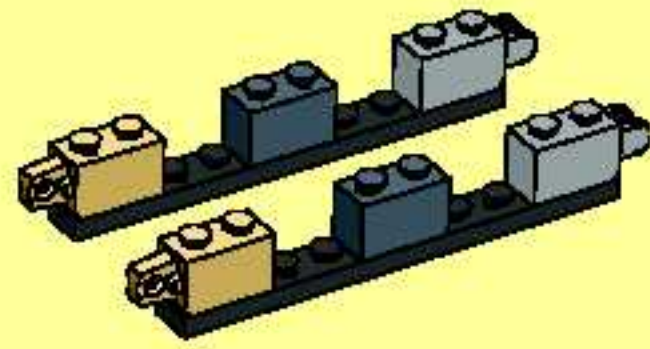

3

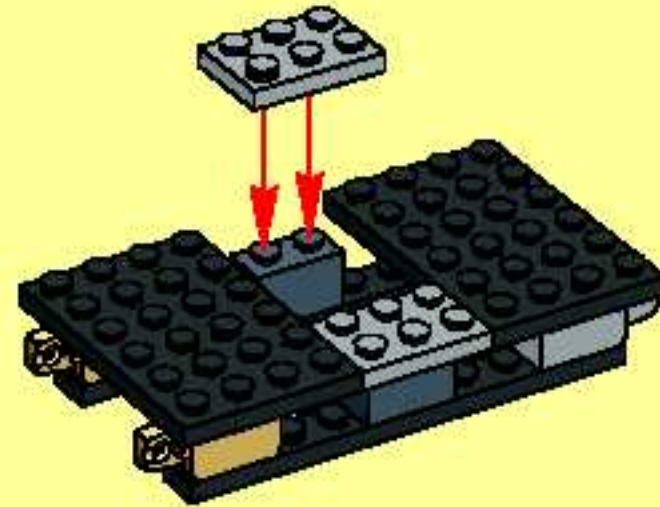

4

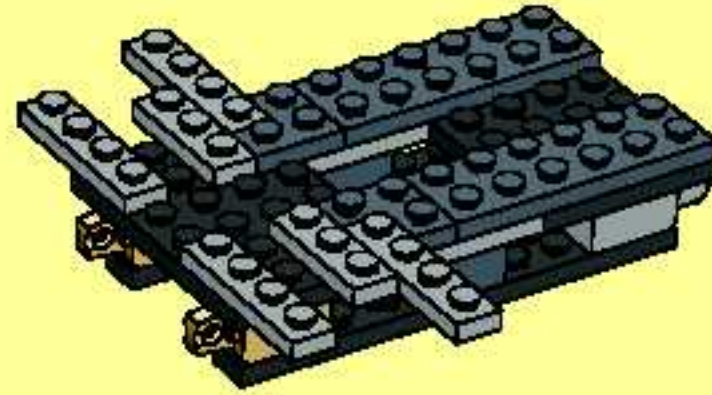

5

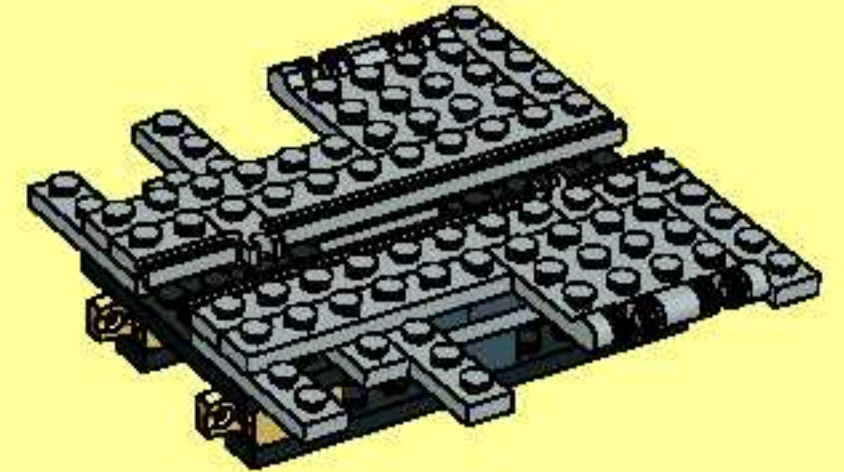

1



2

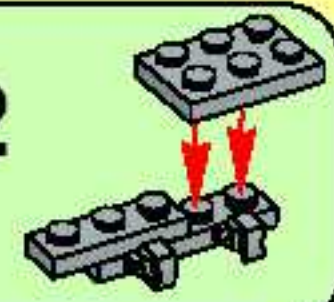

6

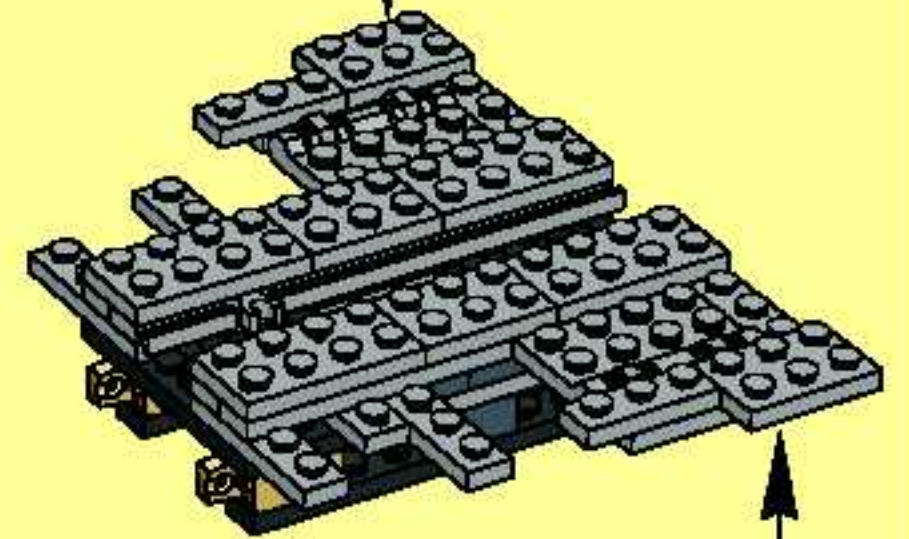

1



2

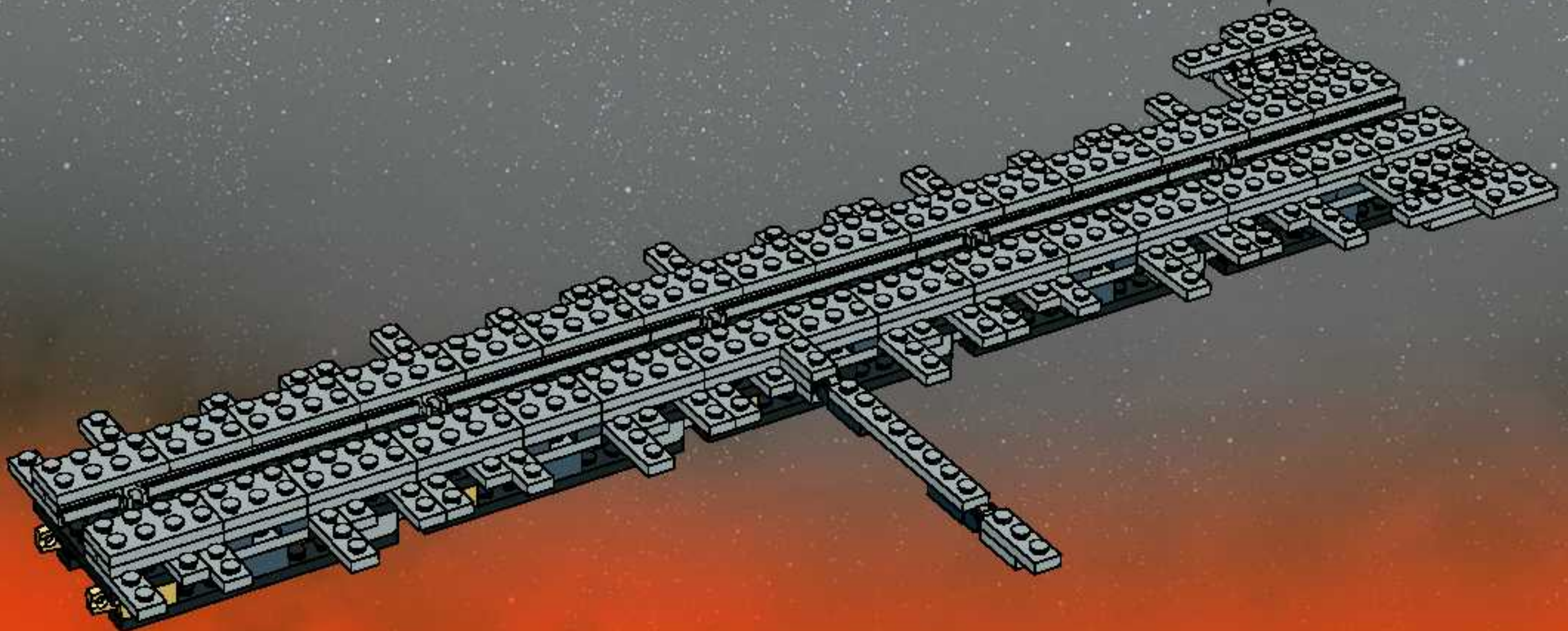
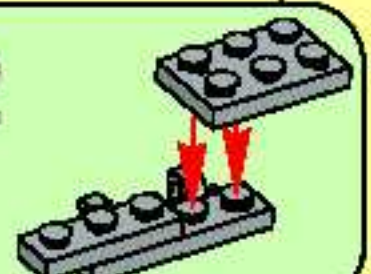



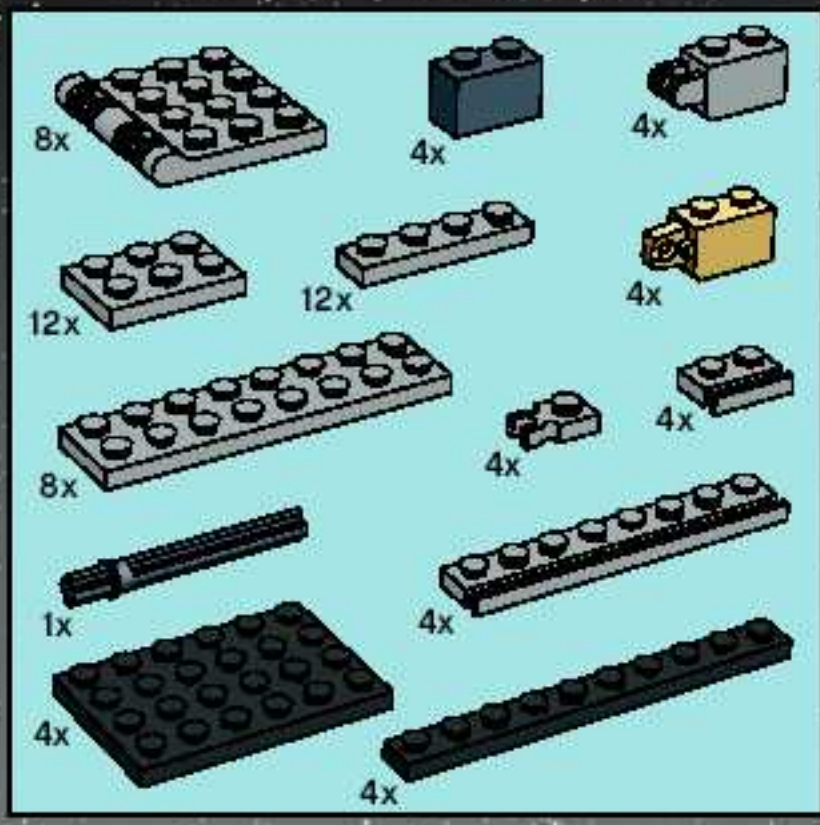

11

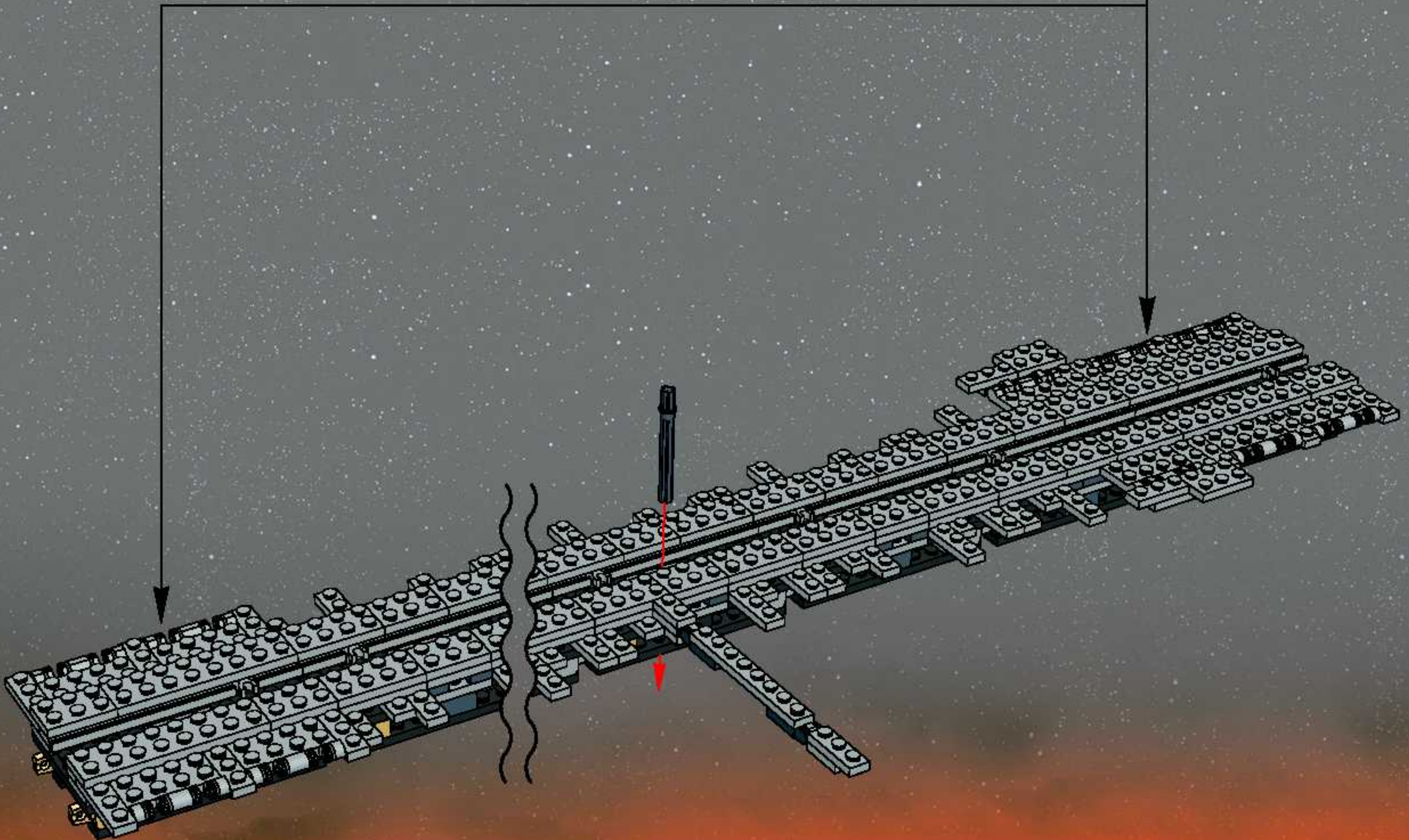
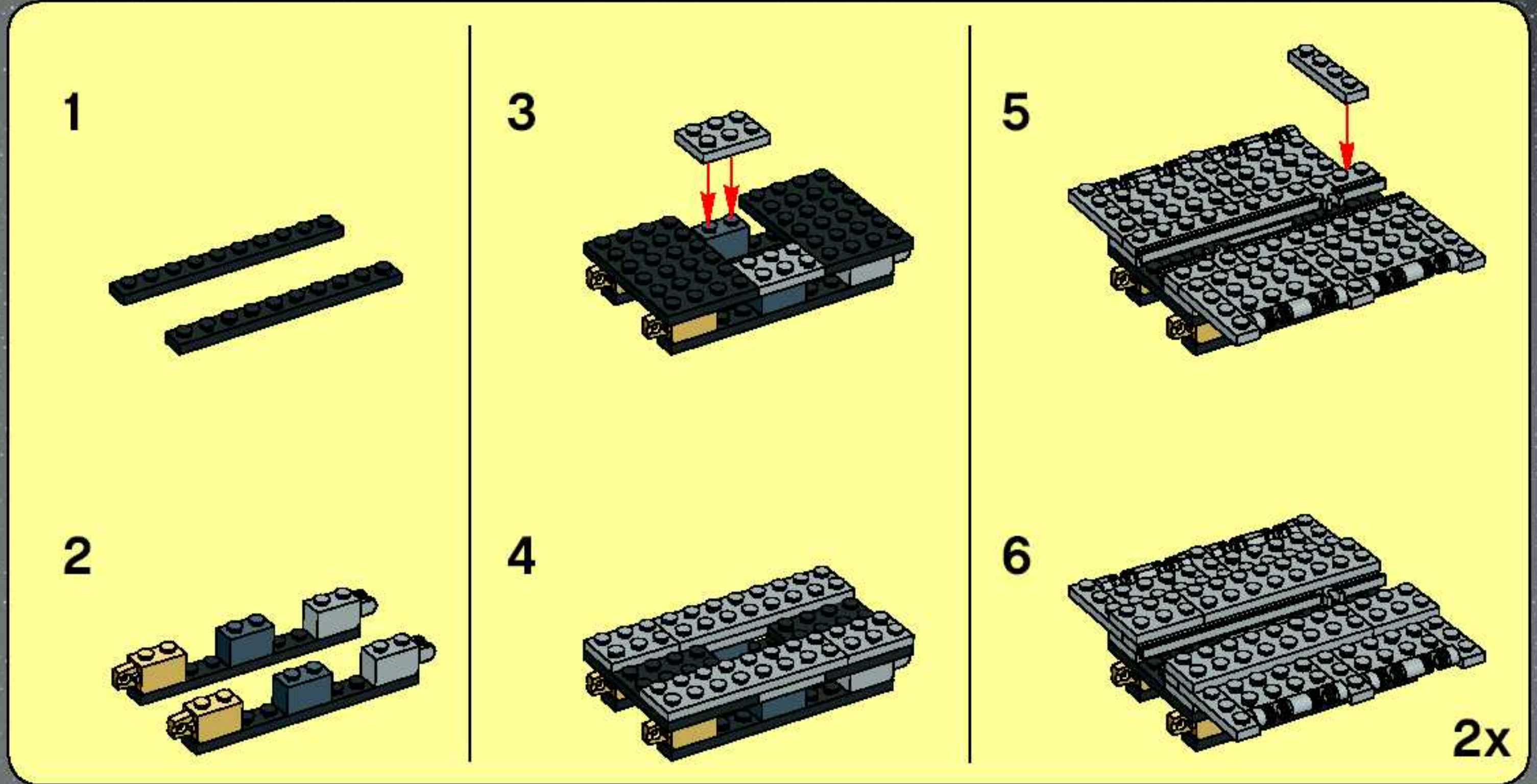



24

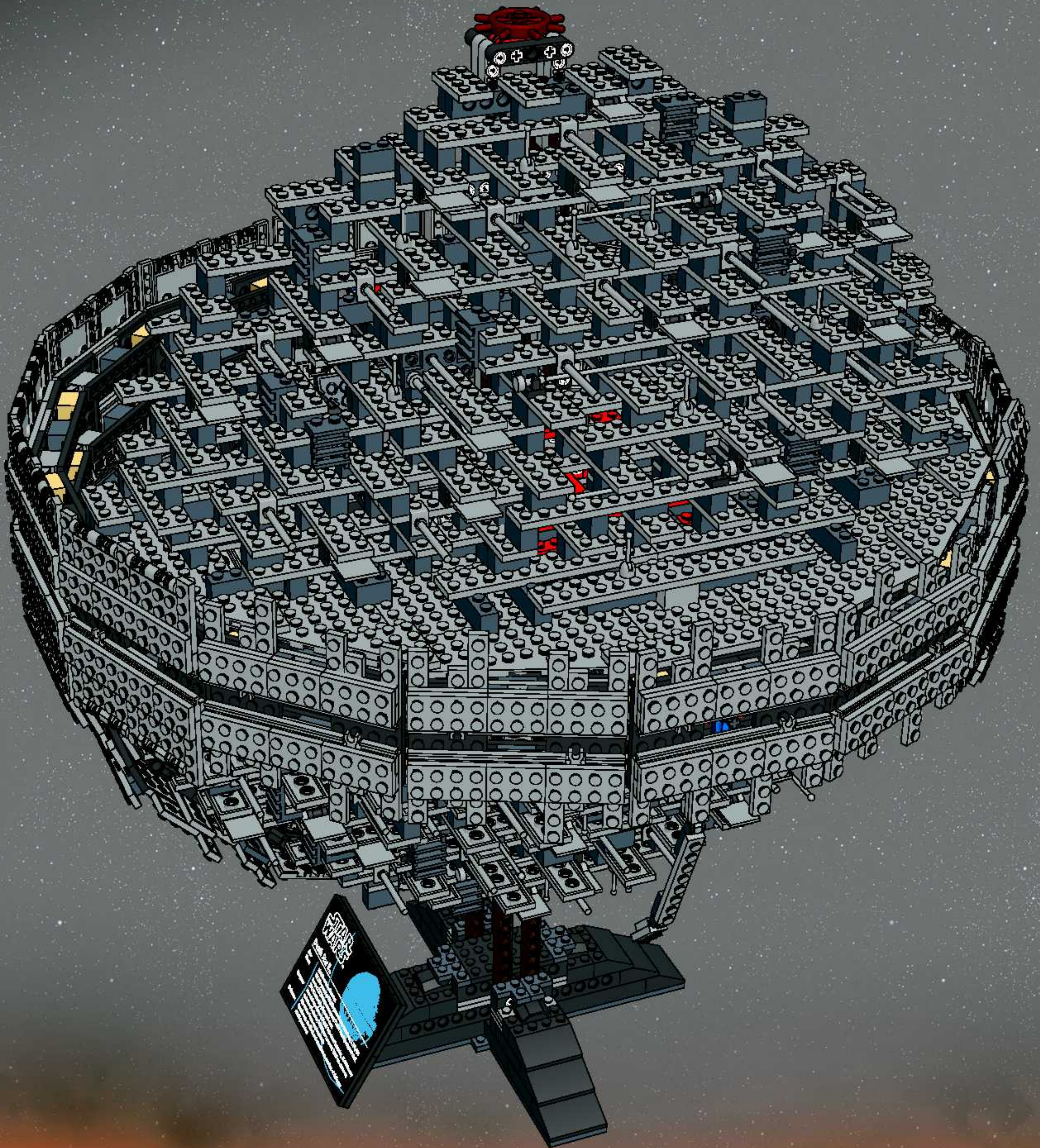



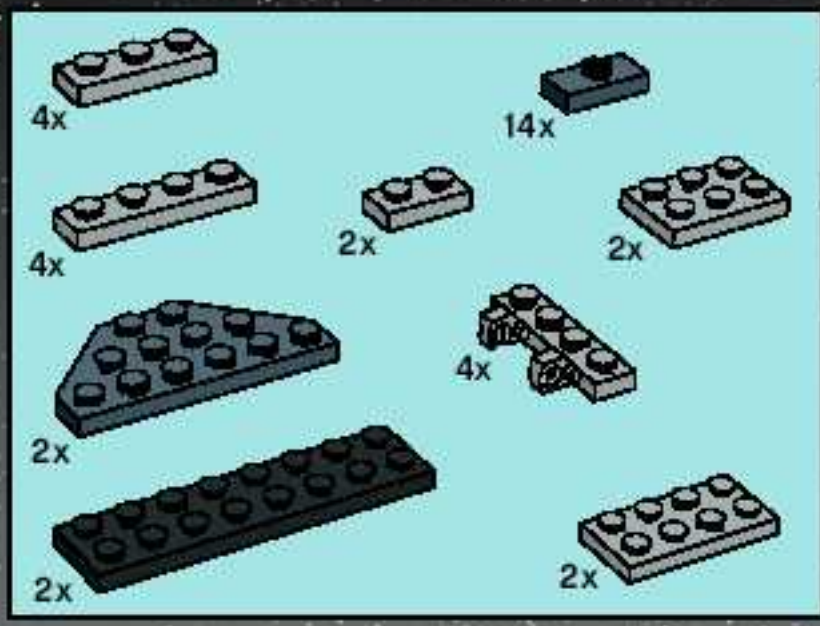

25

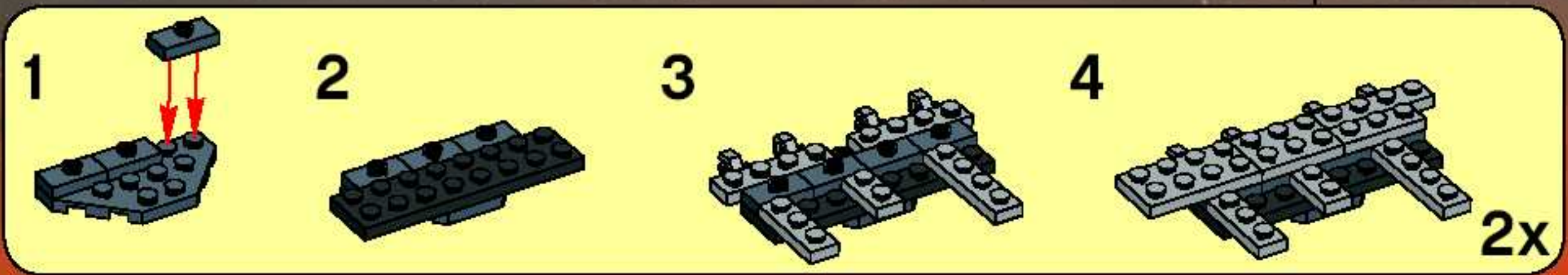
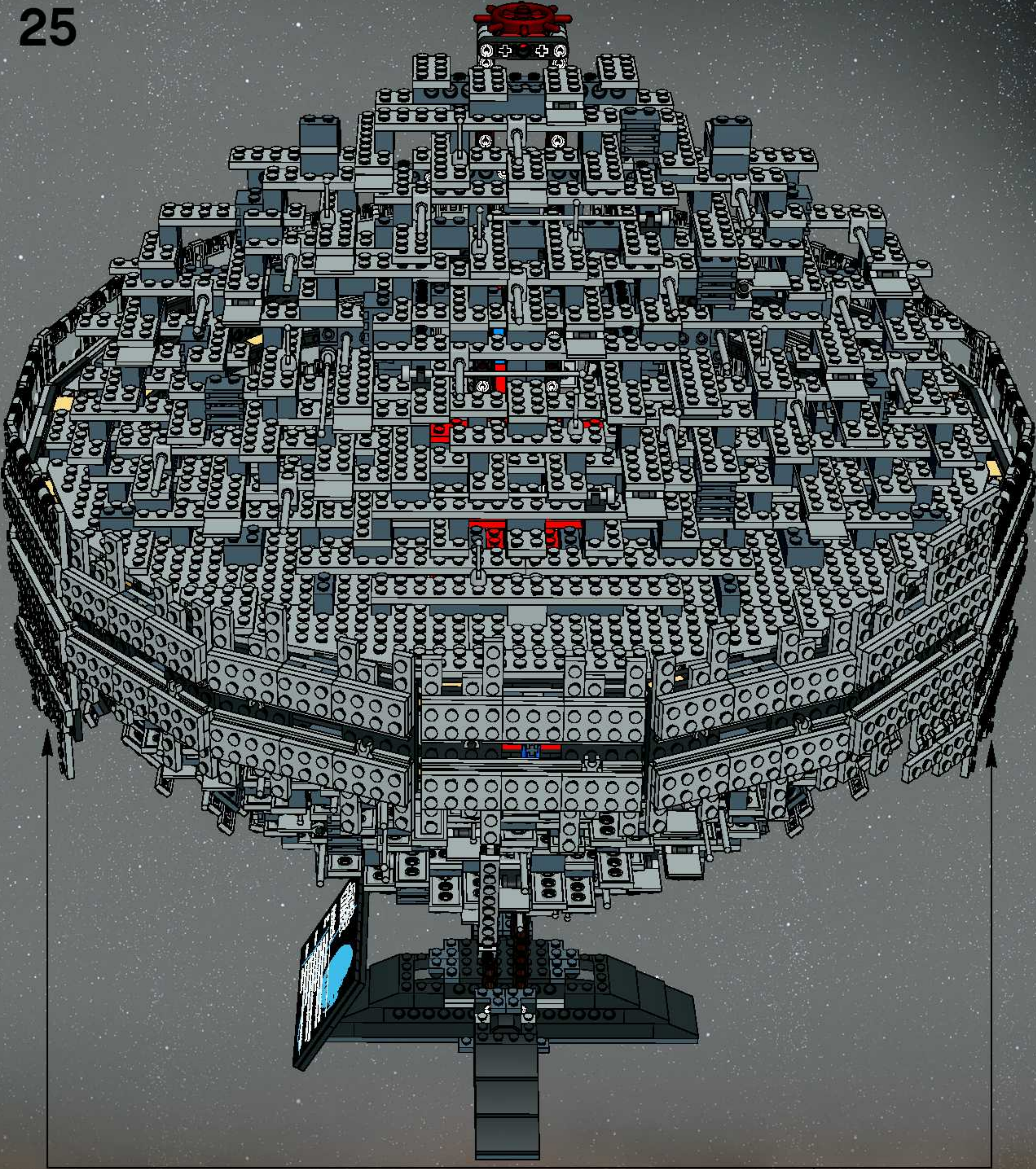



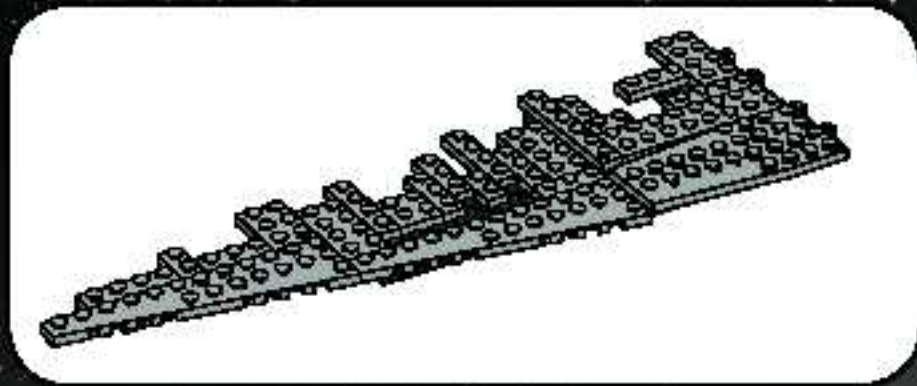

1



2



3

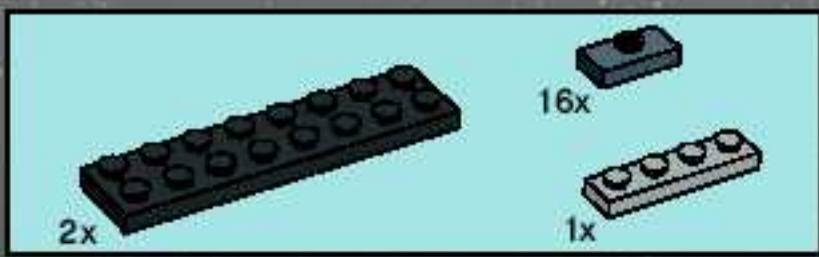

4

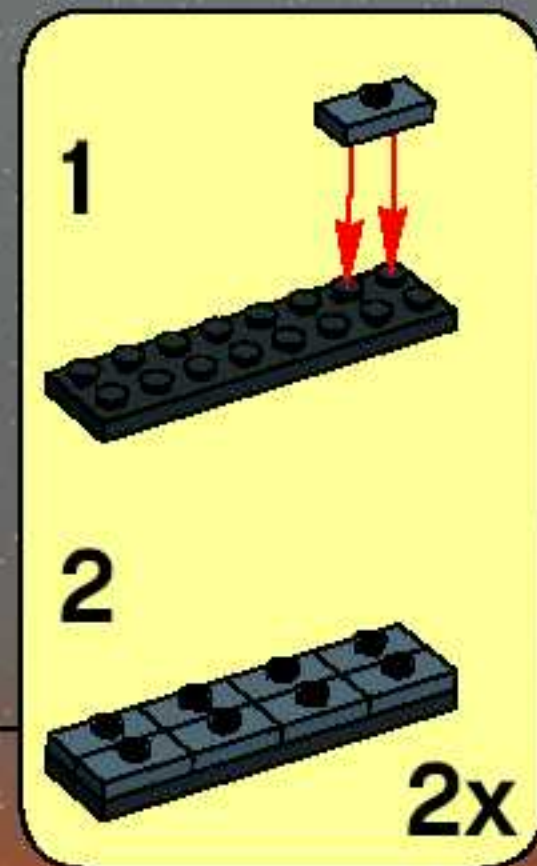
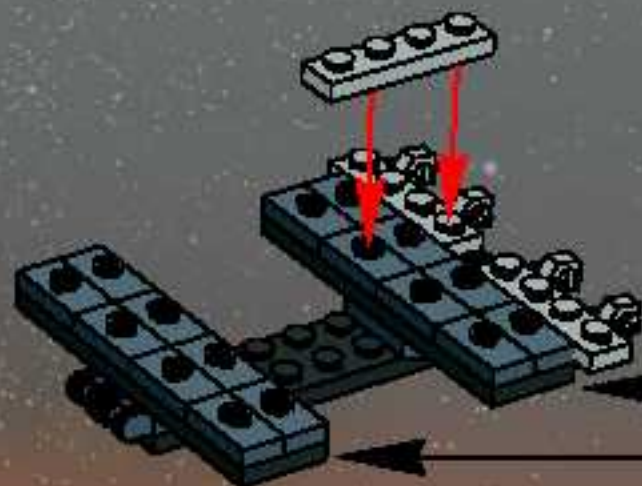



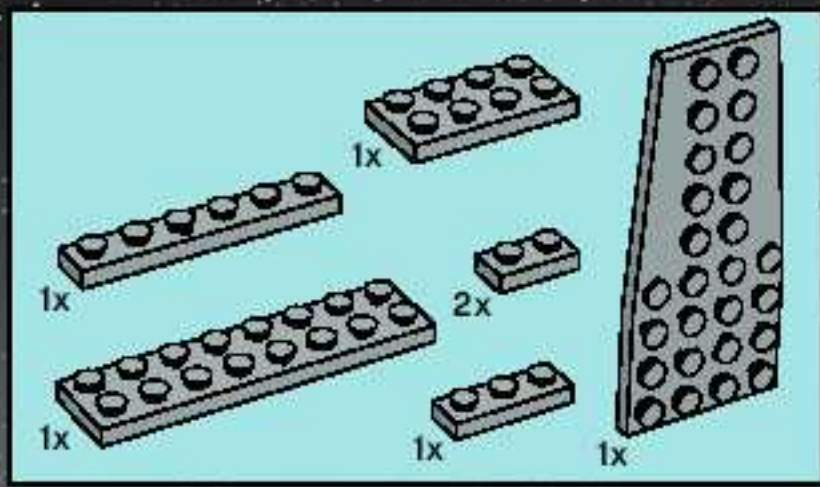

5

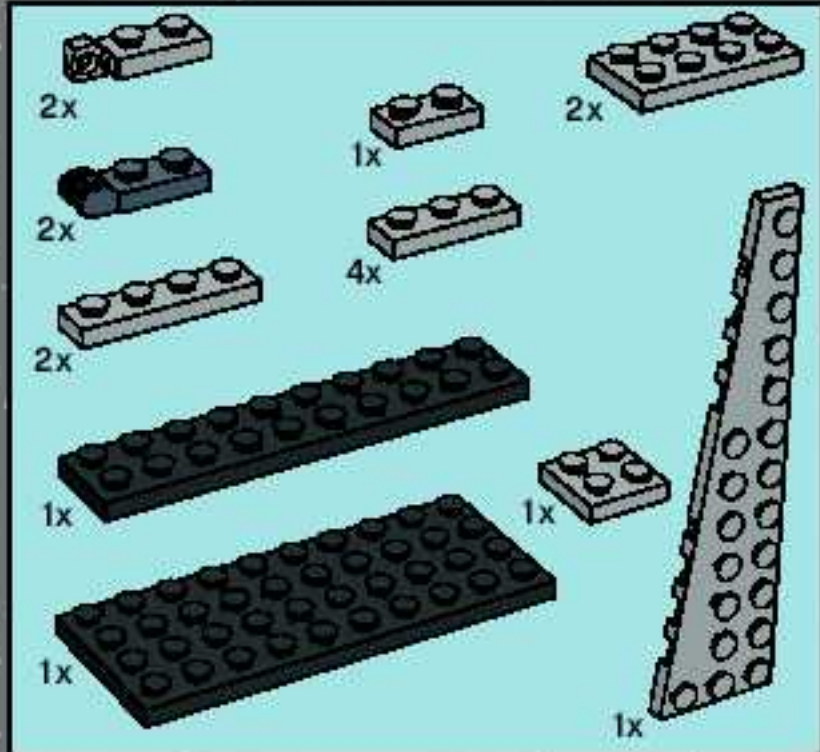

6

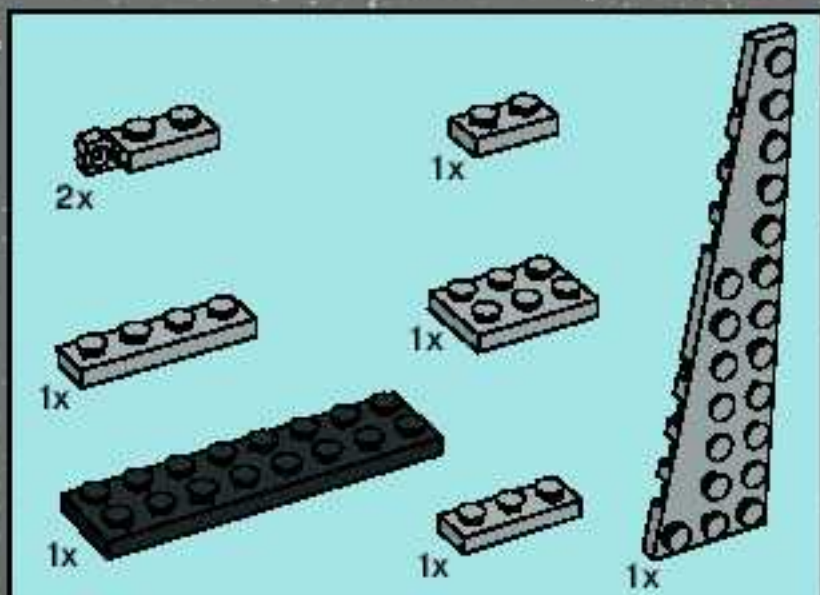
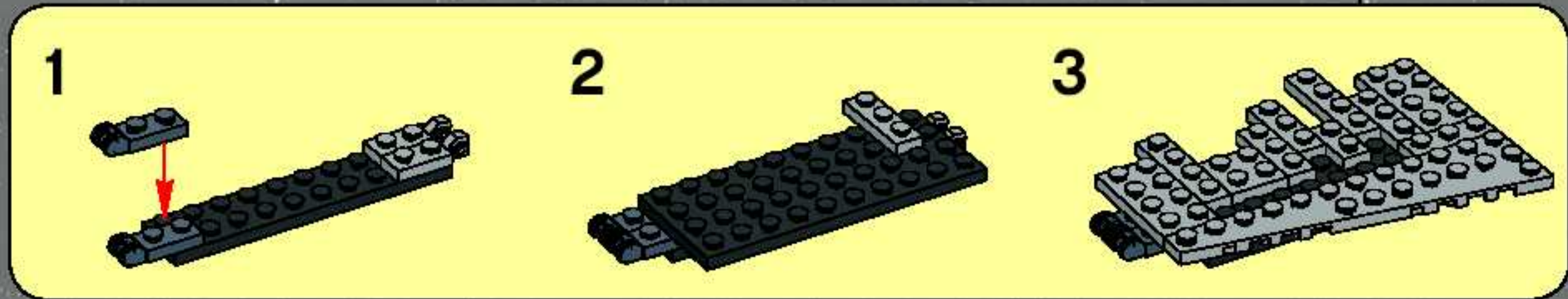
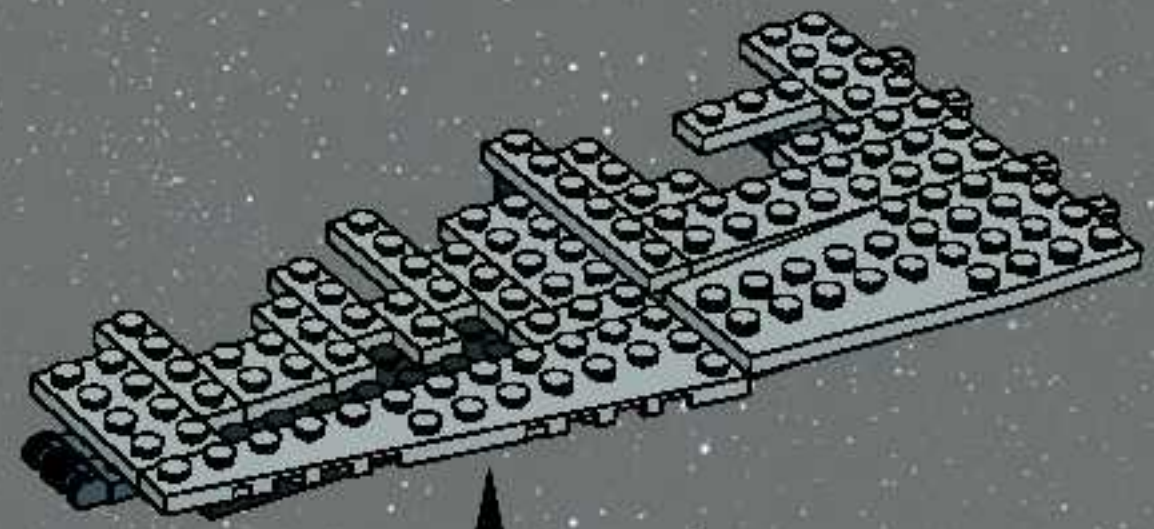

7

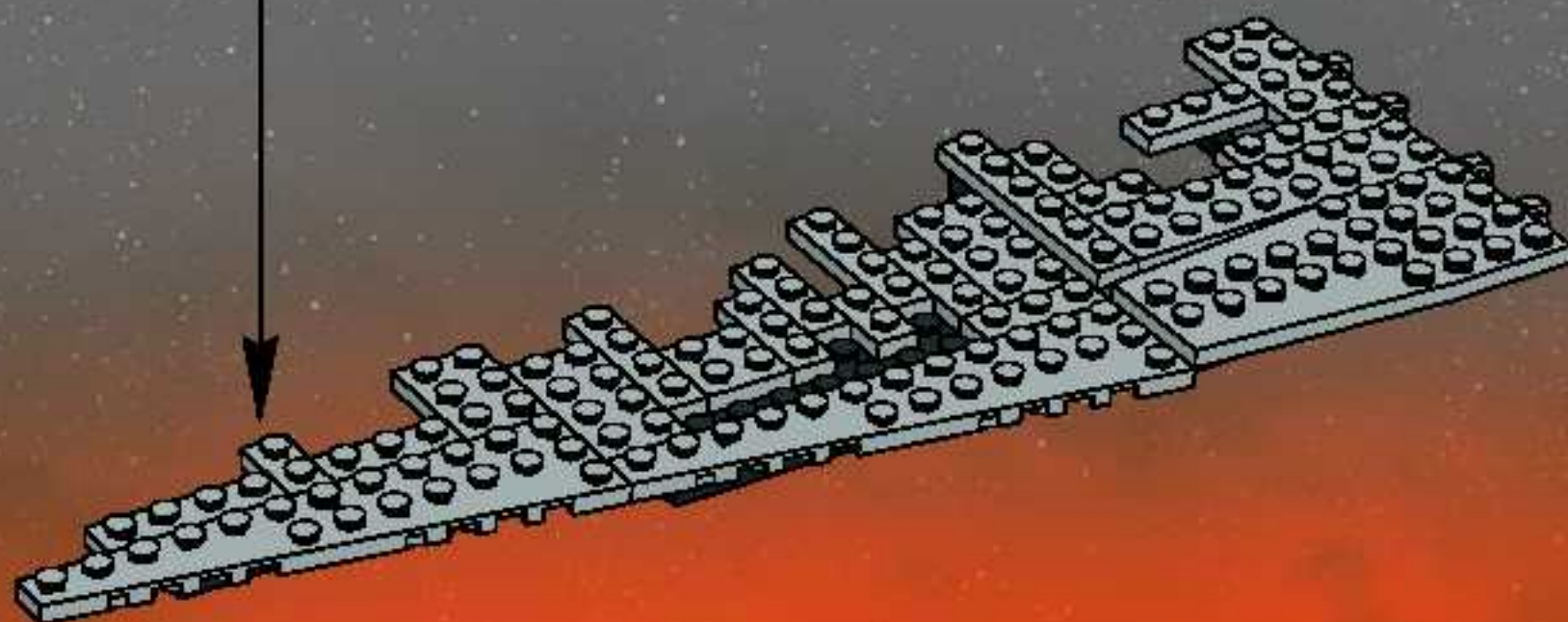



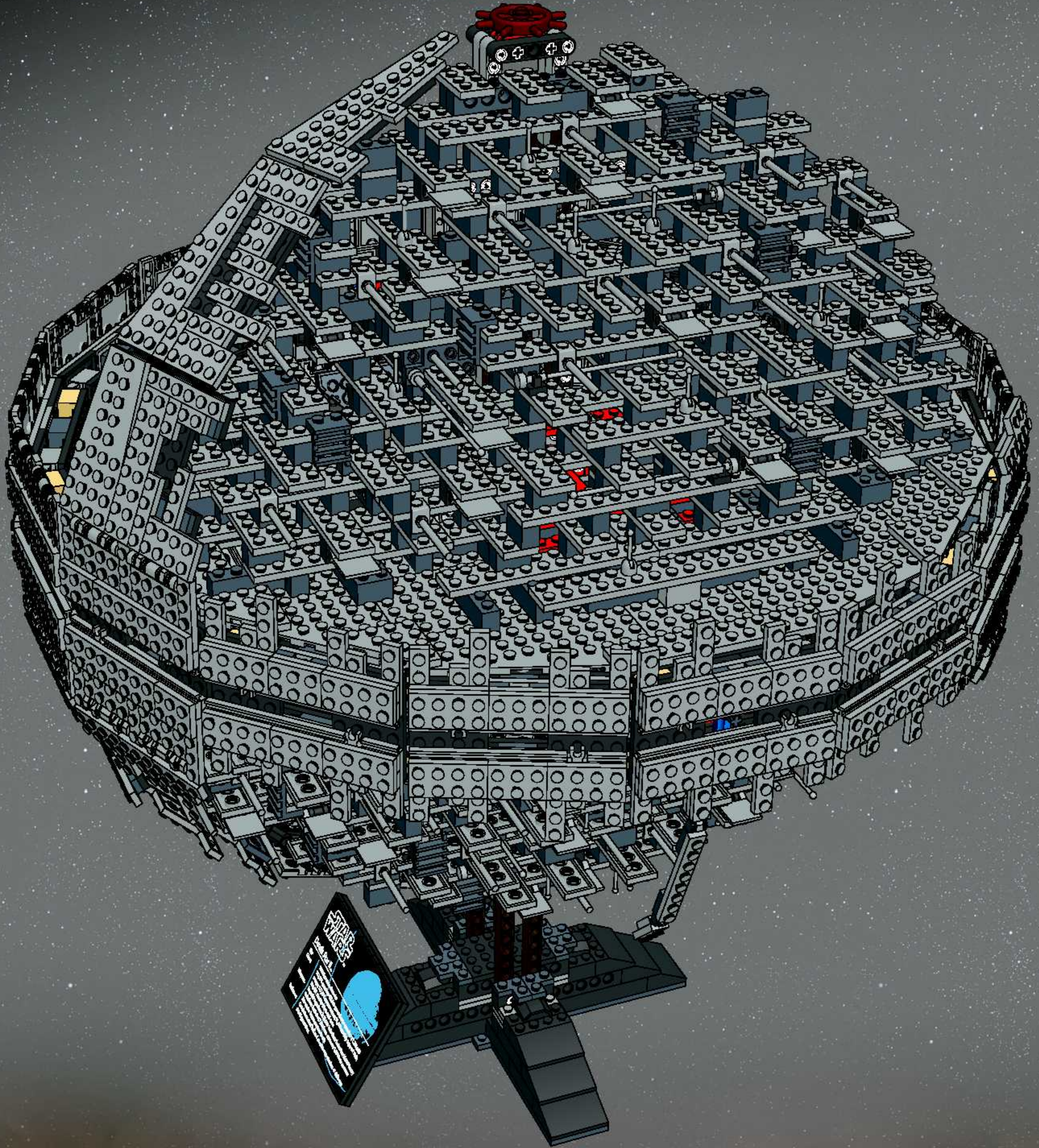



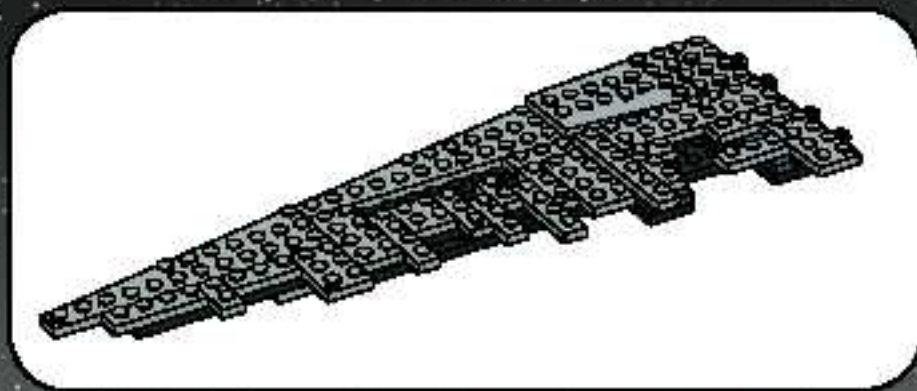

1



2



3

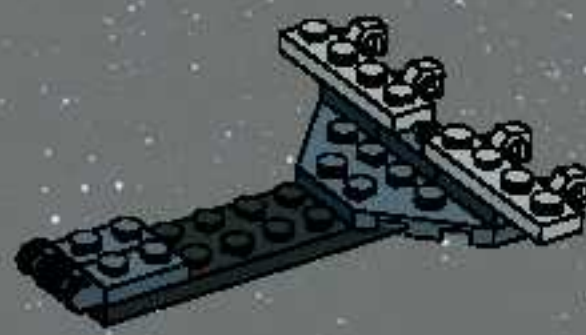

4

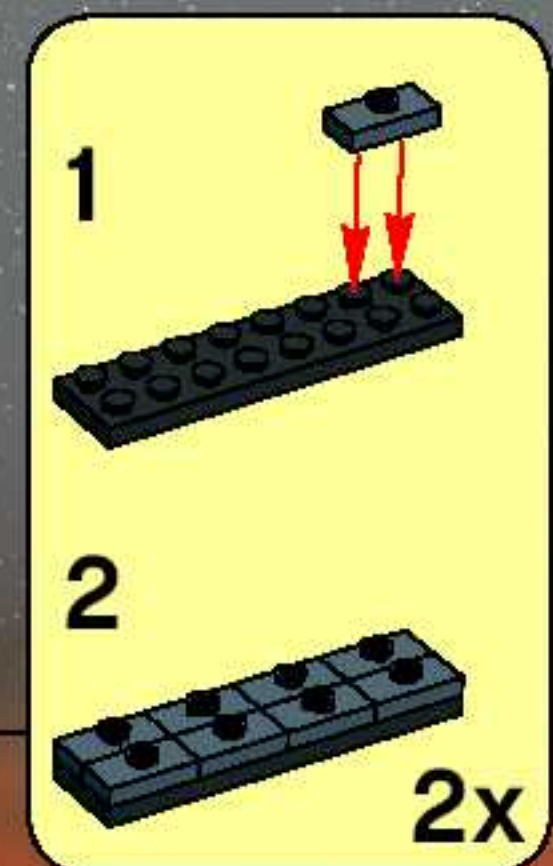
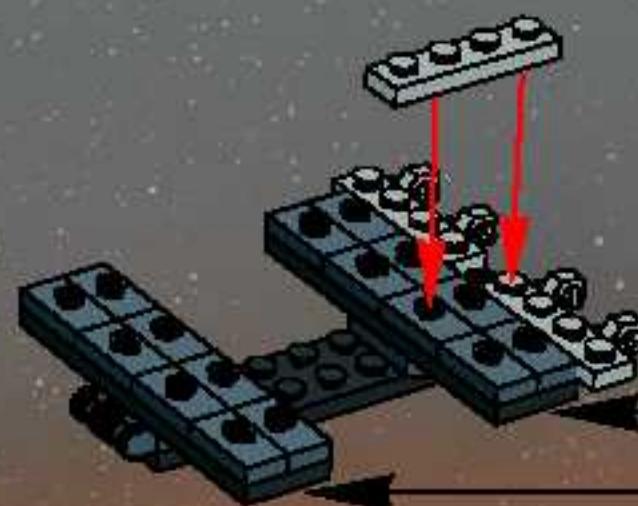



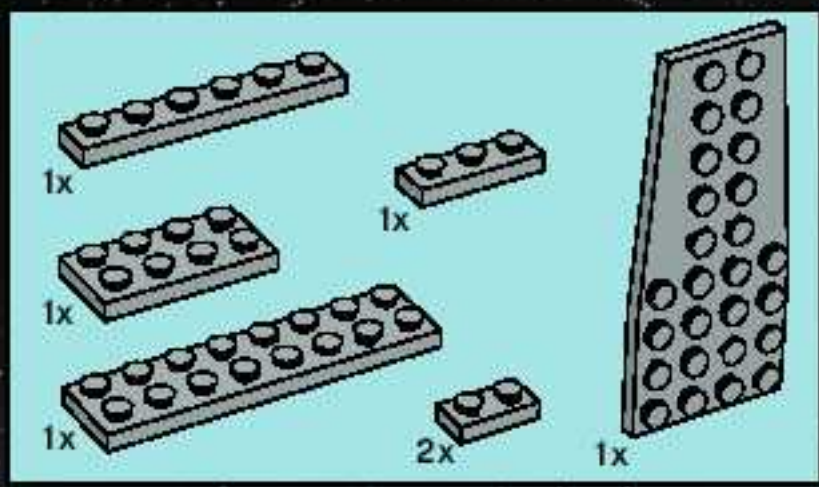

5

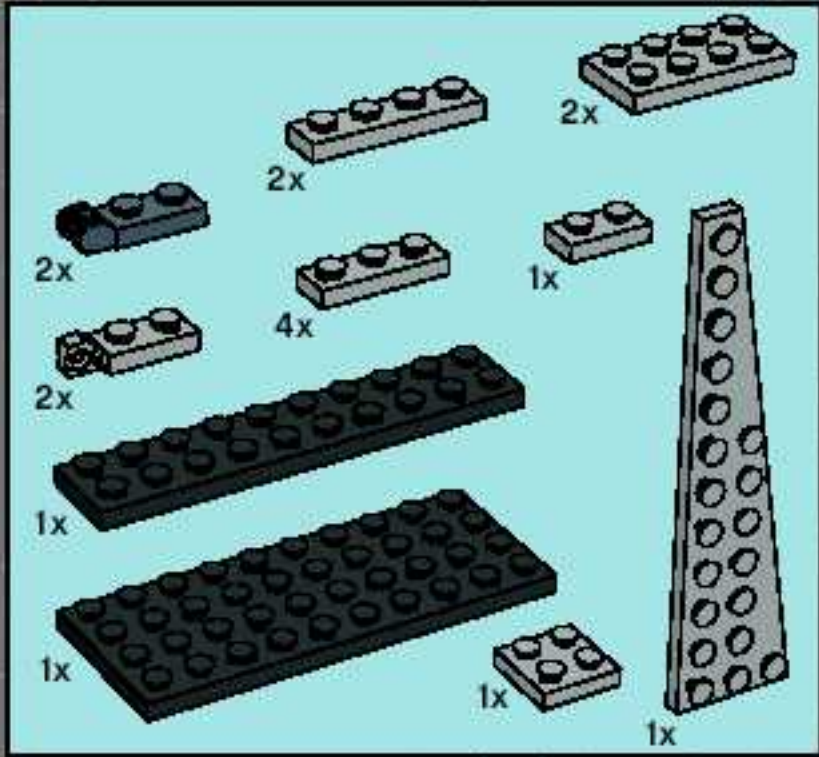

6

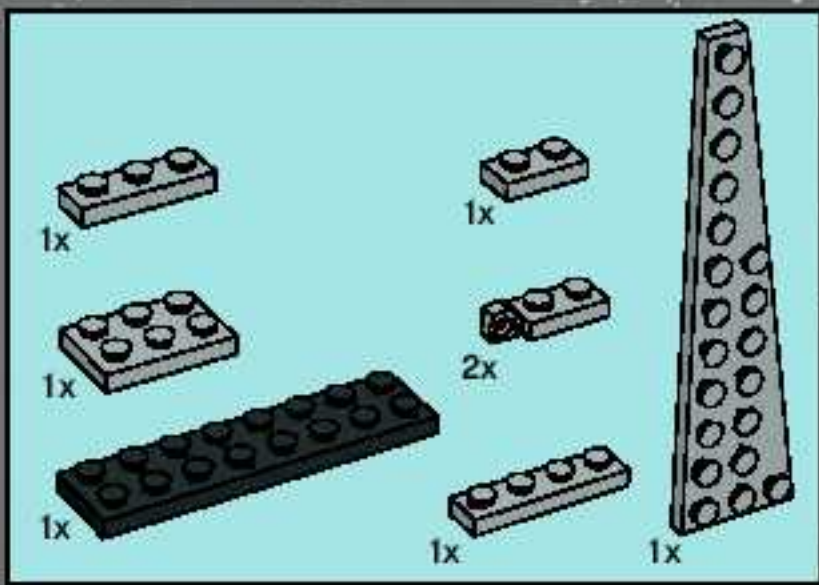
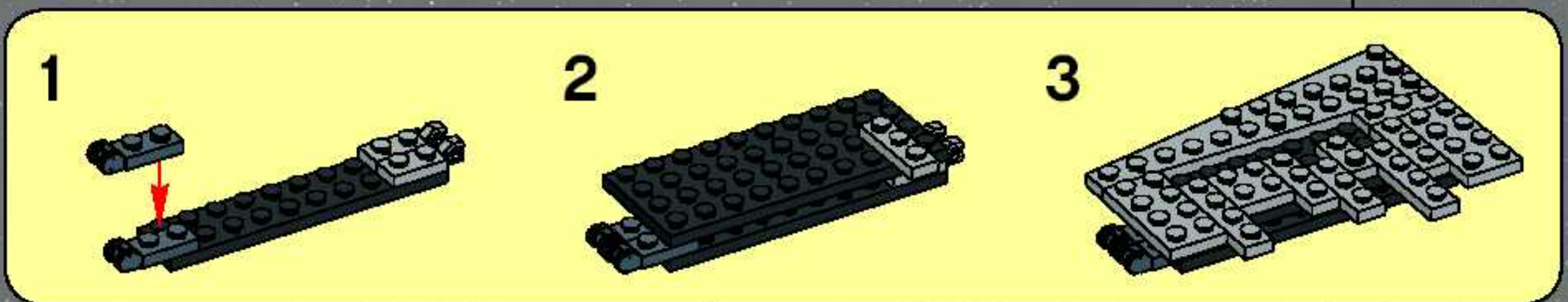

7

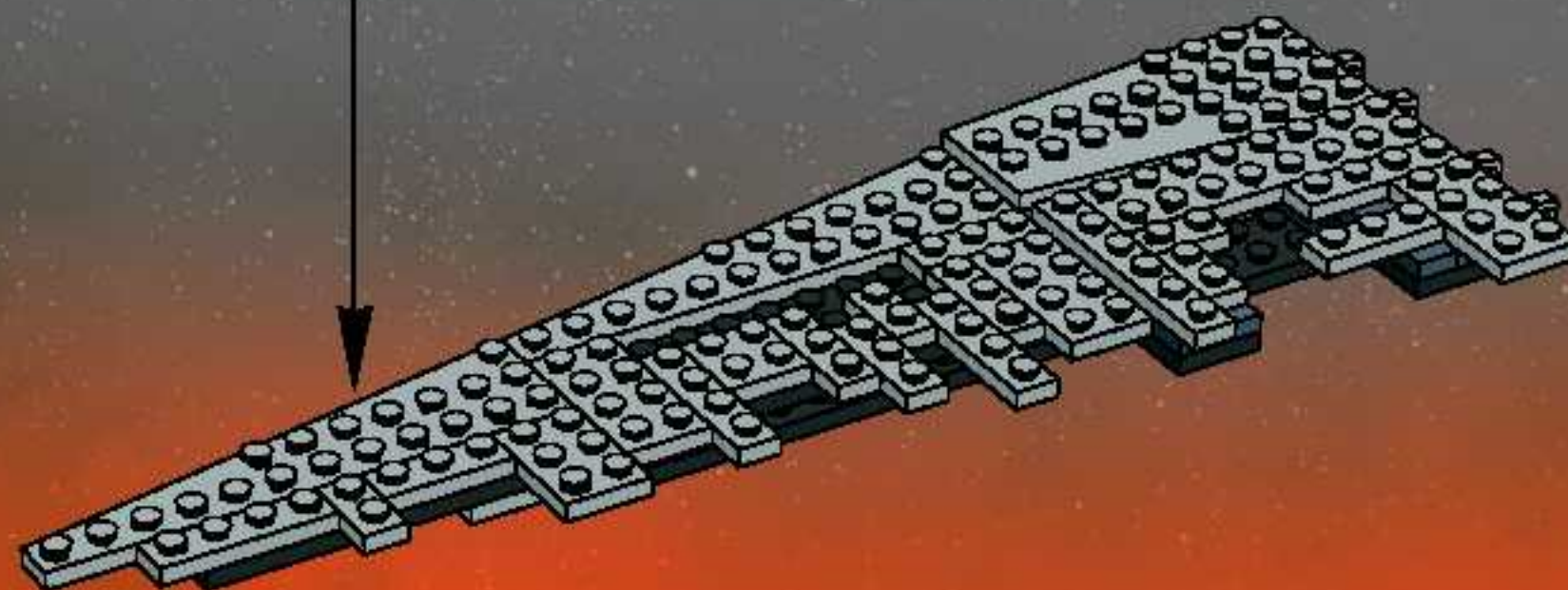



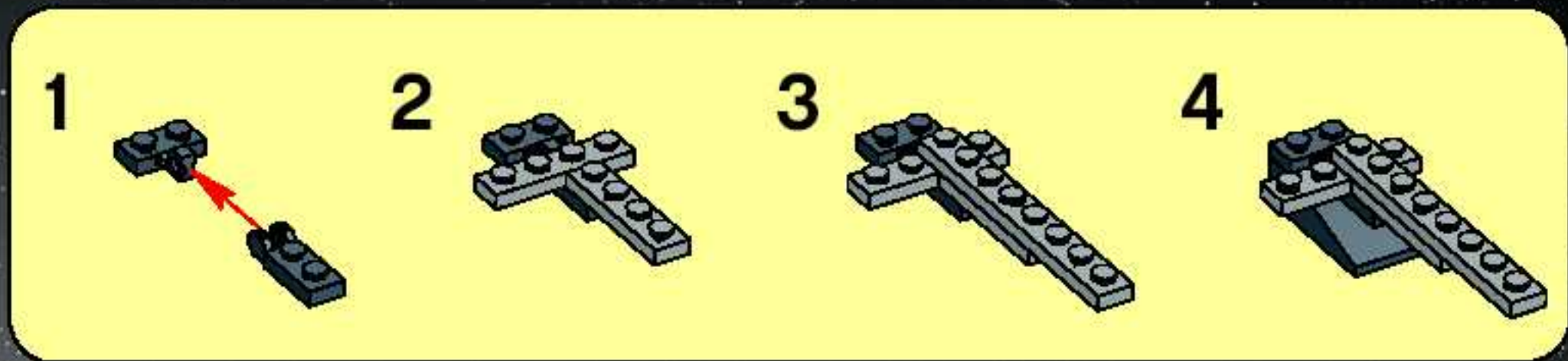
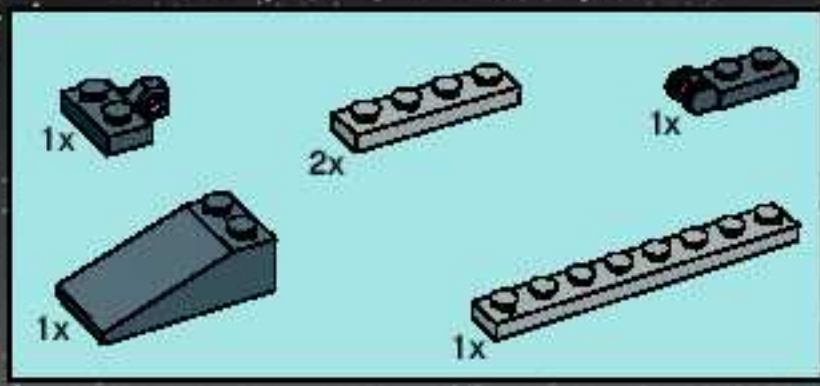

27

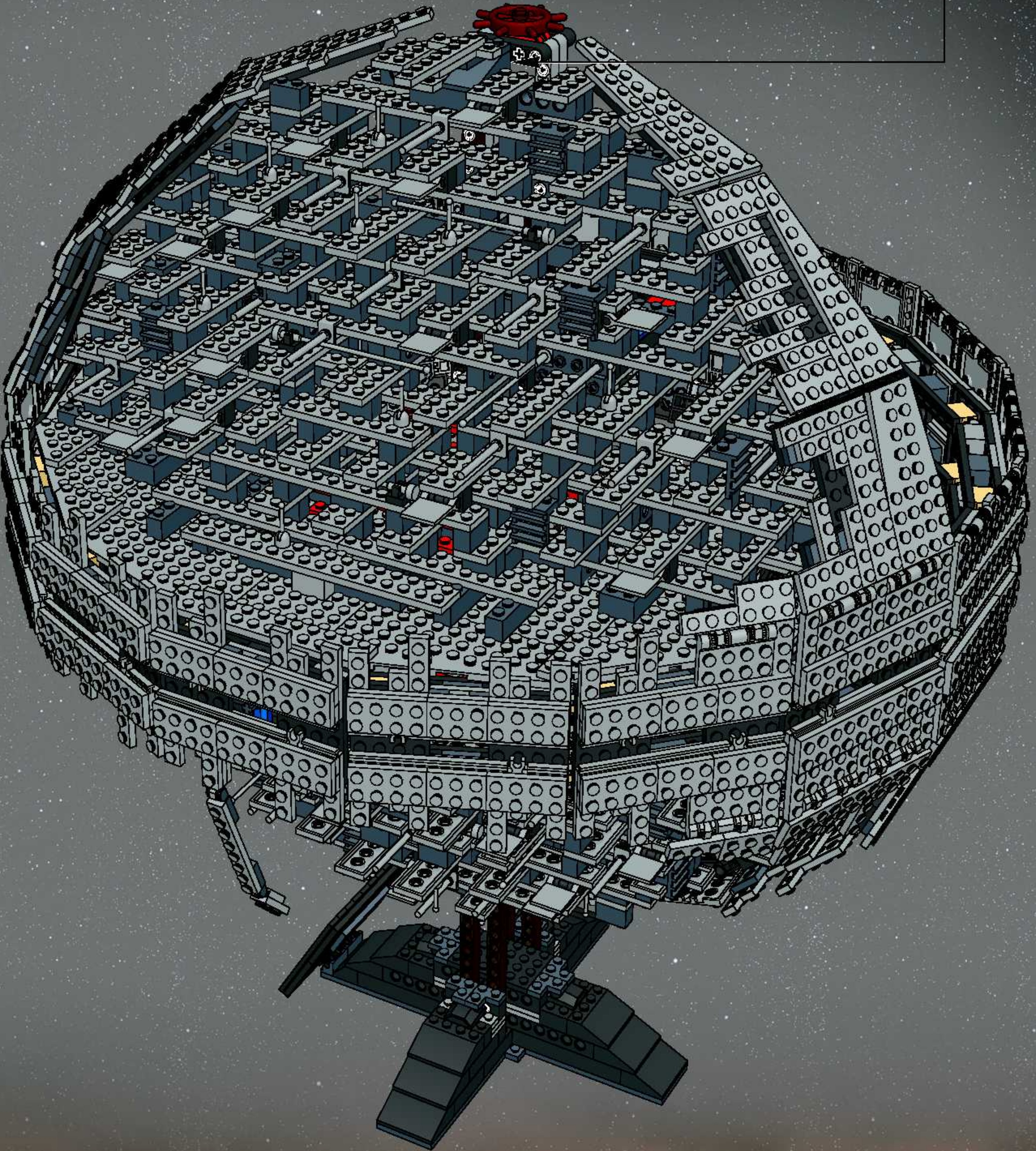



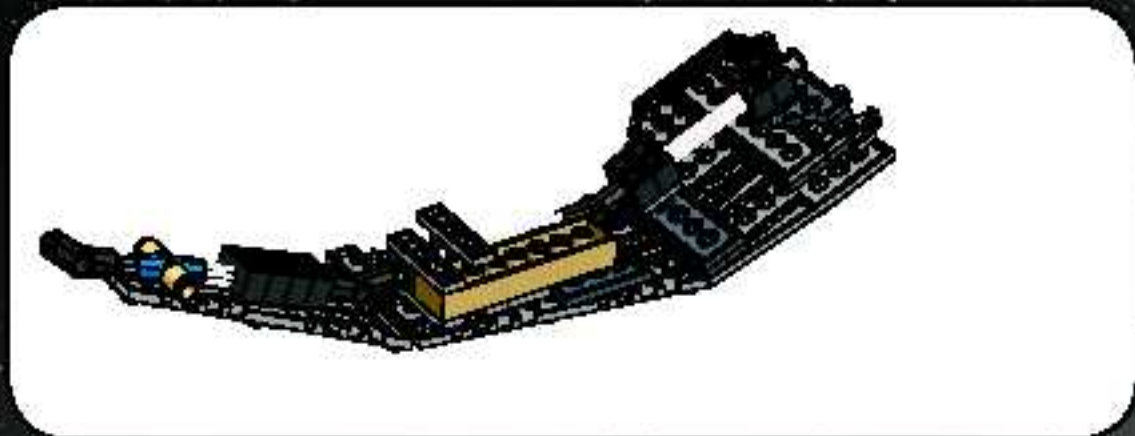

1

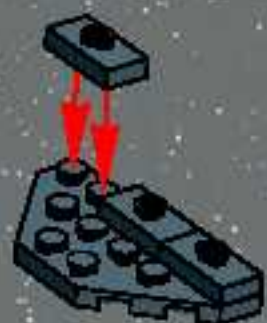

2

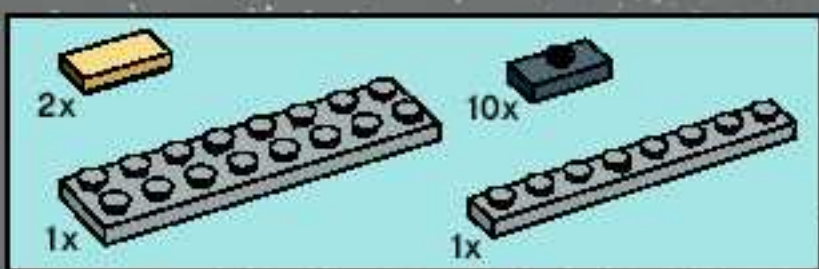

3

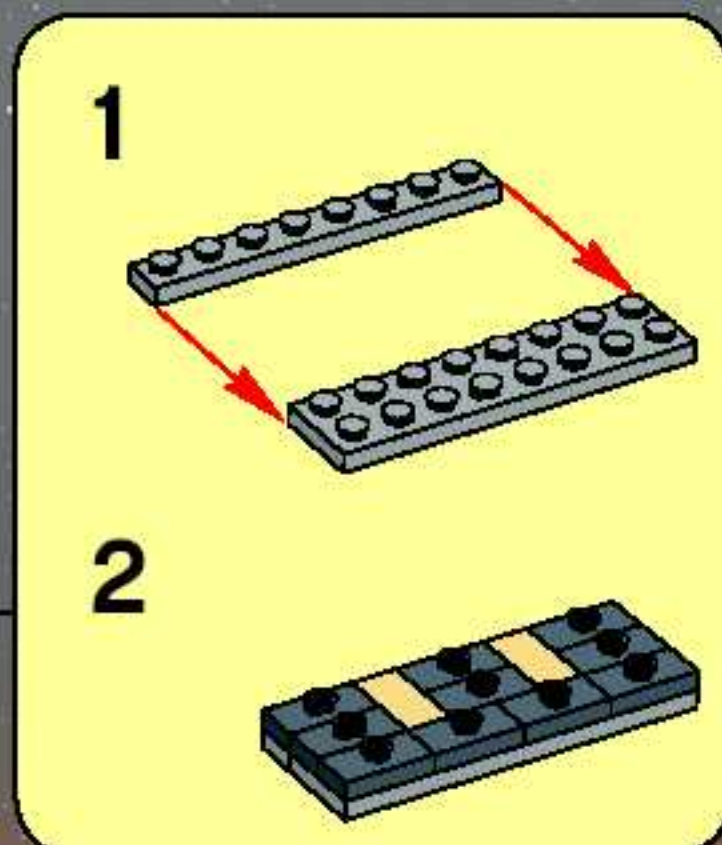
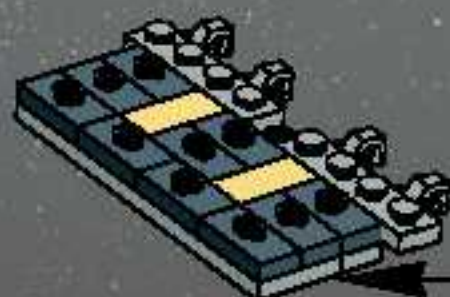



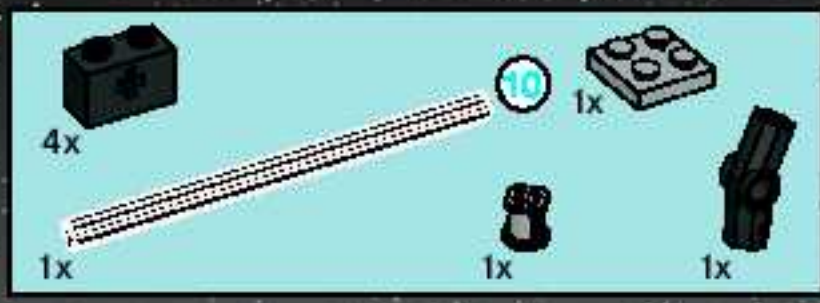

4

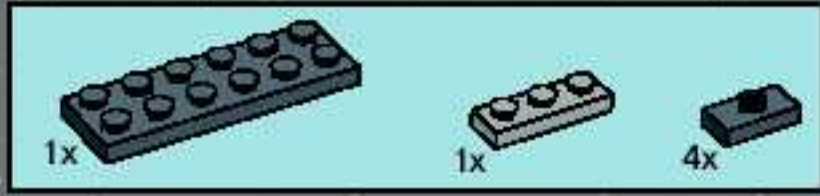
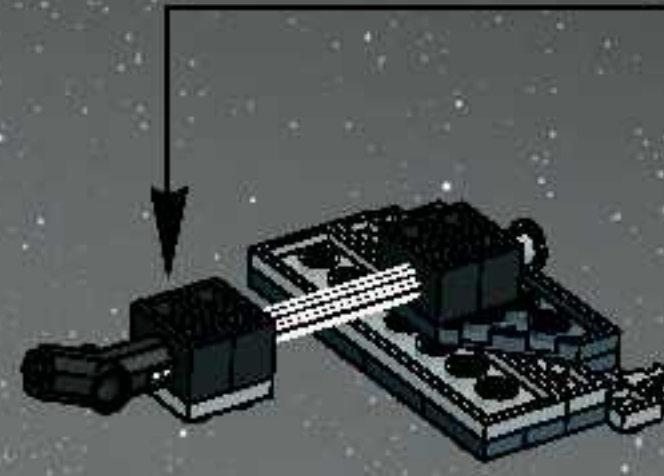
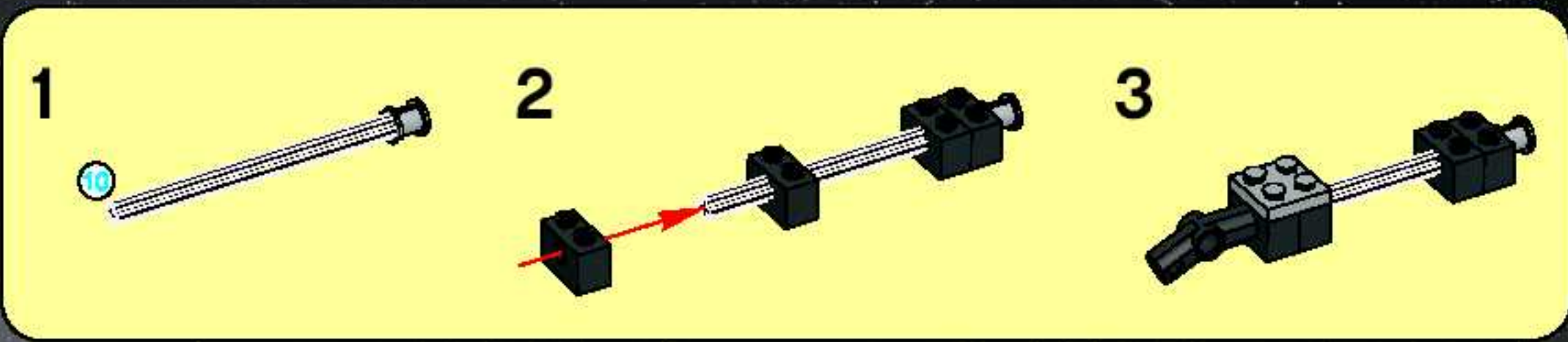

5

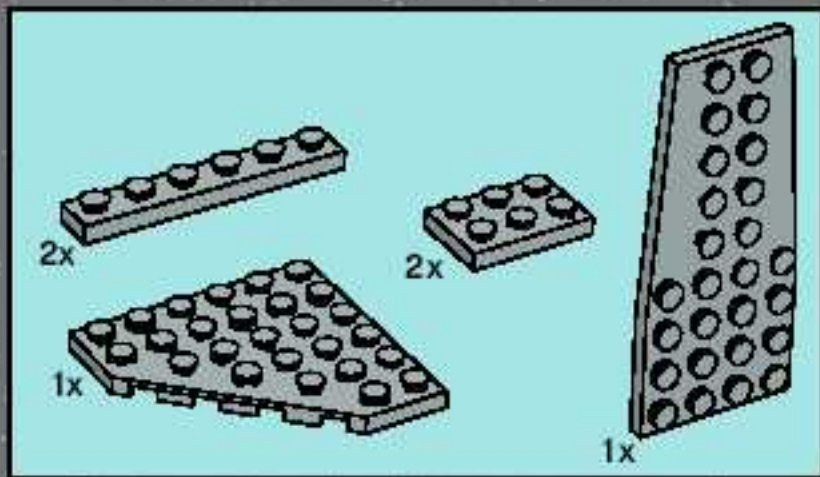
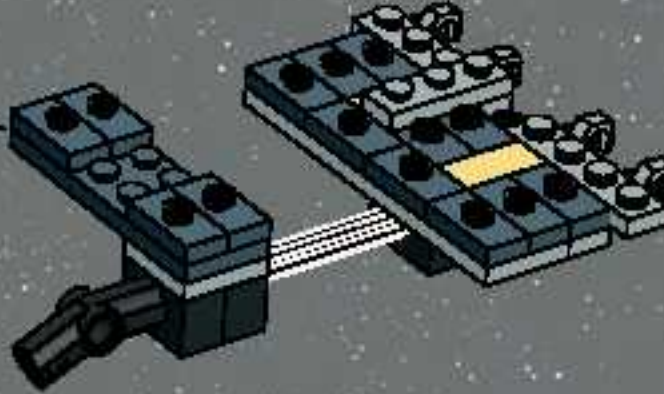
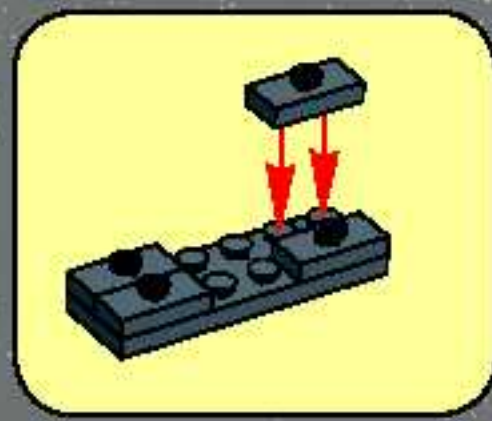

6

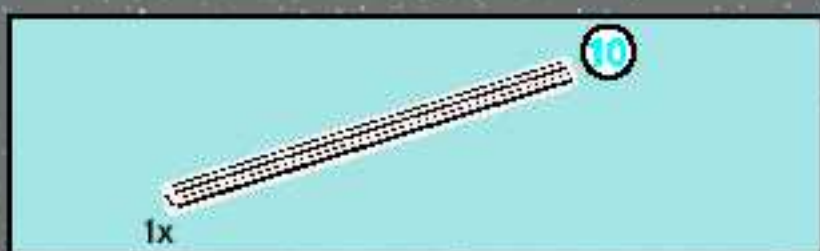

7

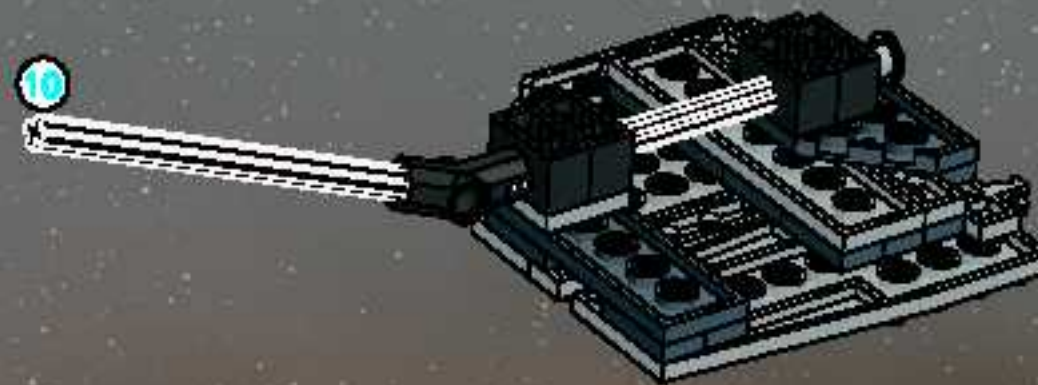



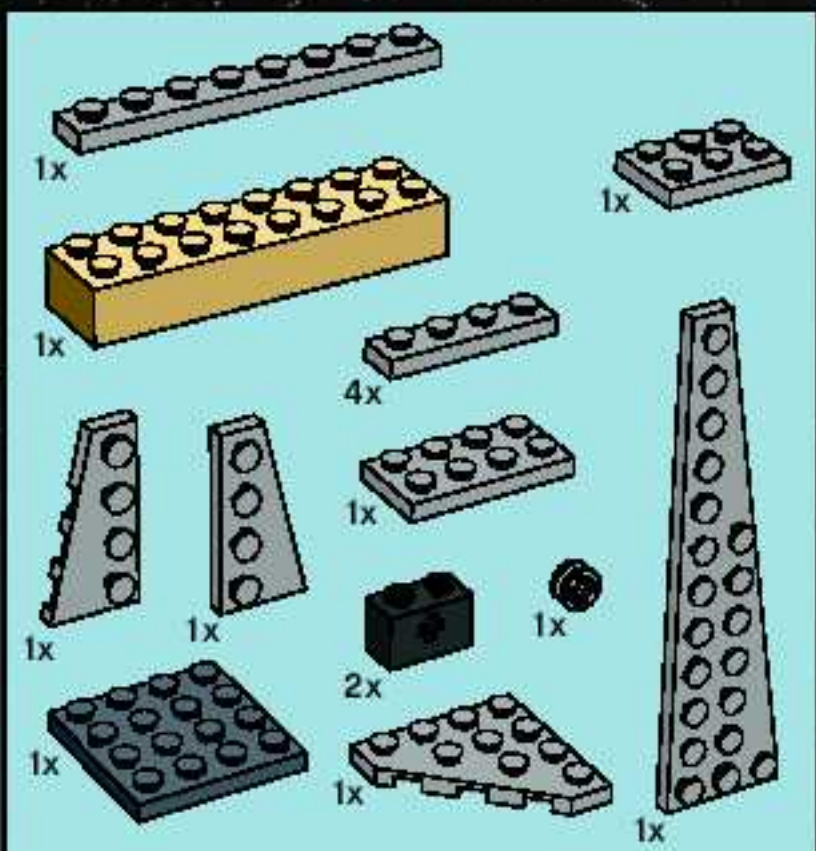

8

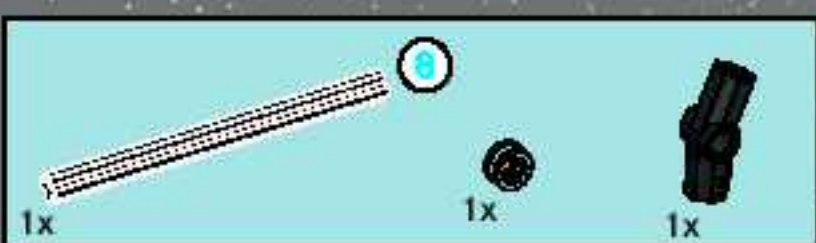
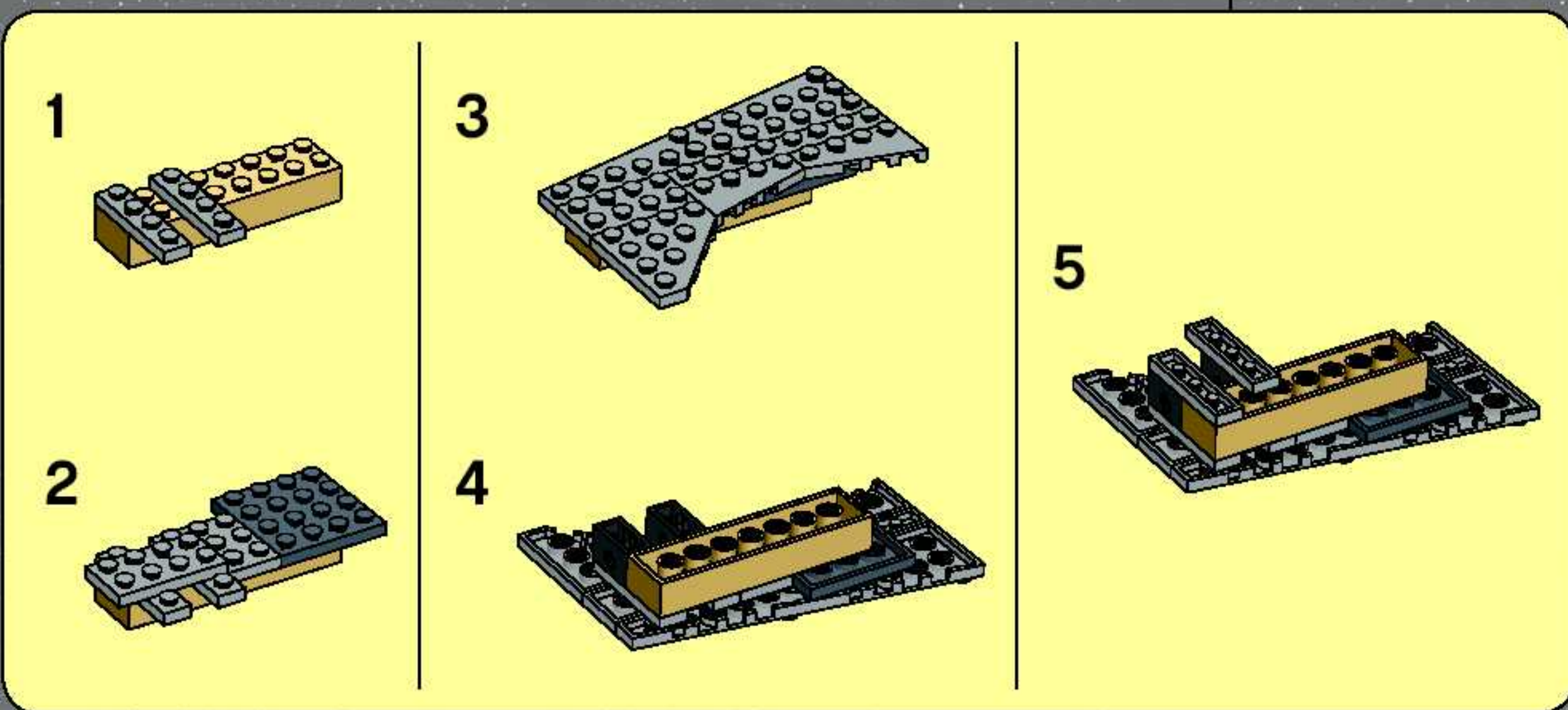
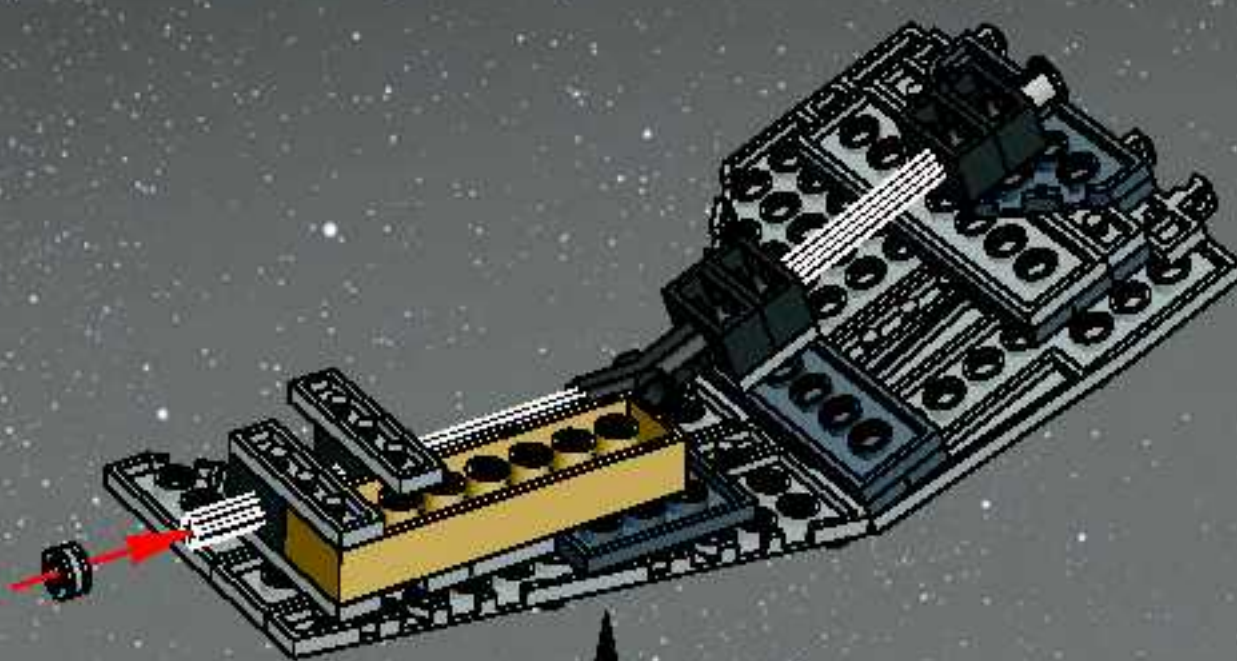

9

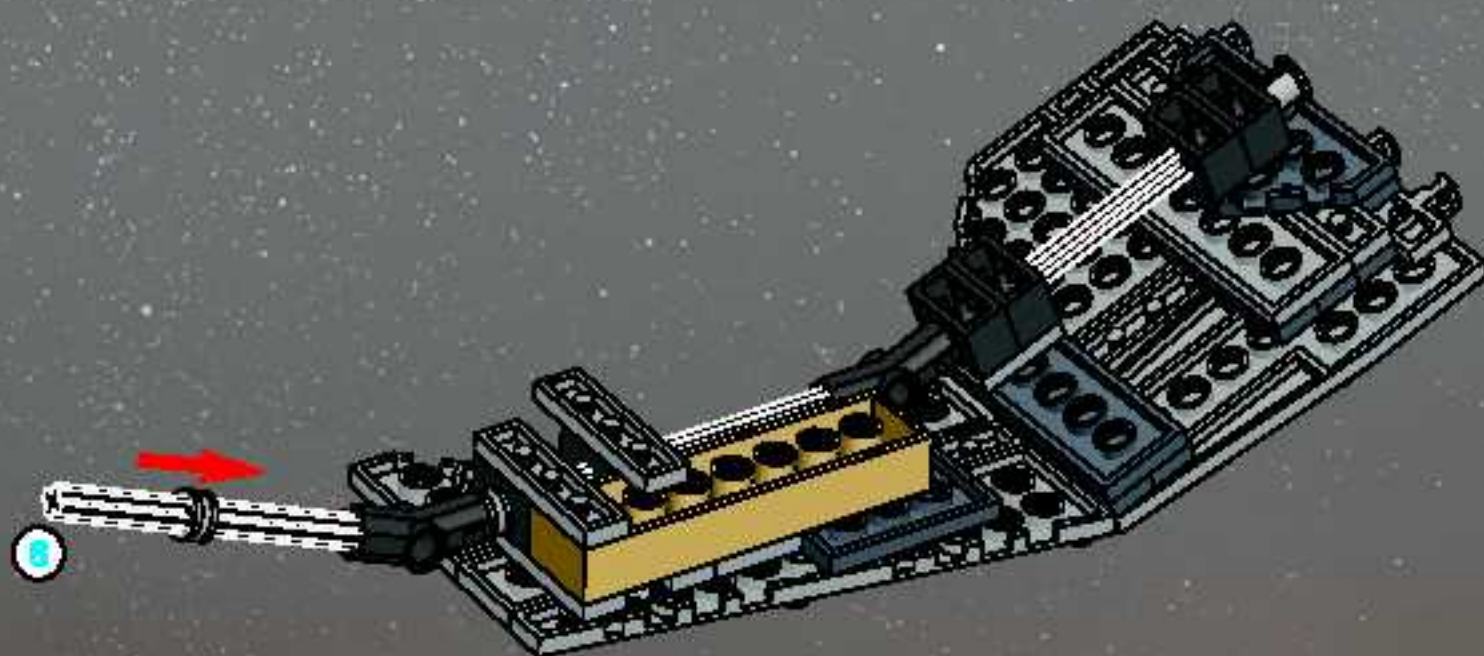



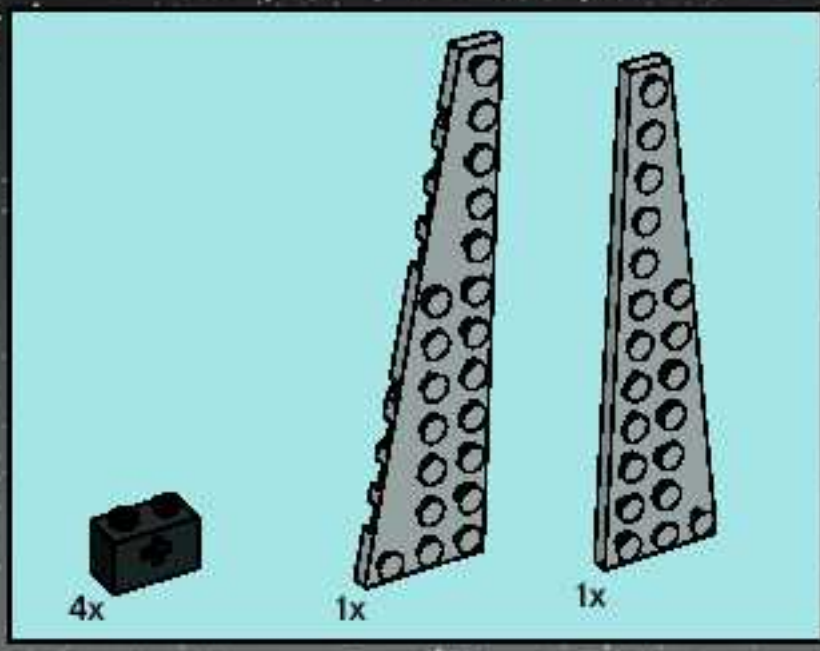

10

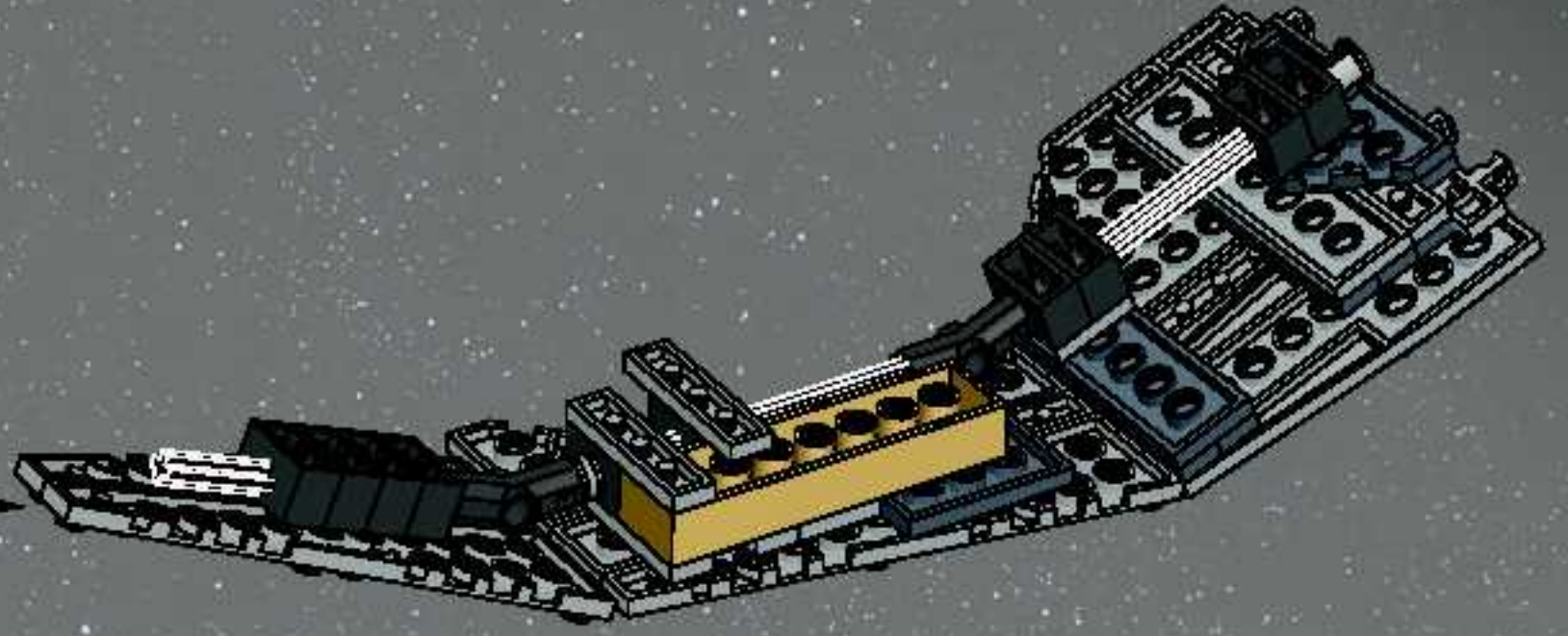
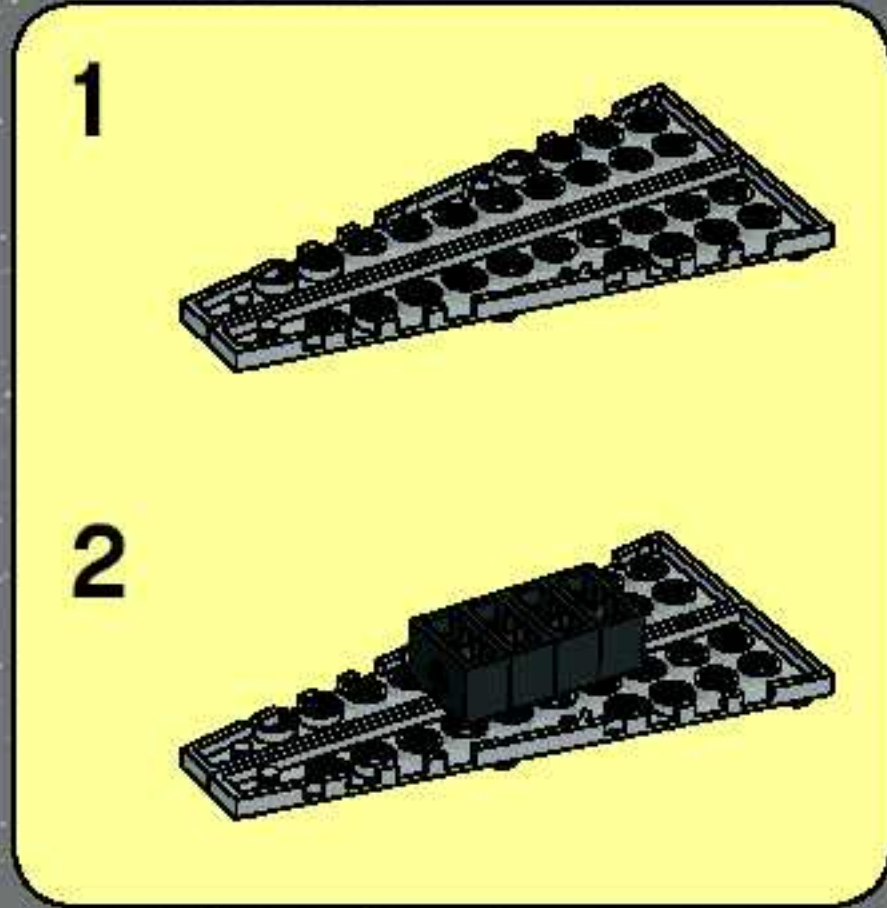

11

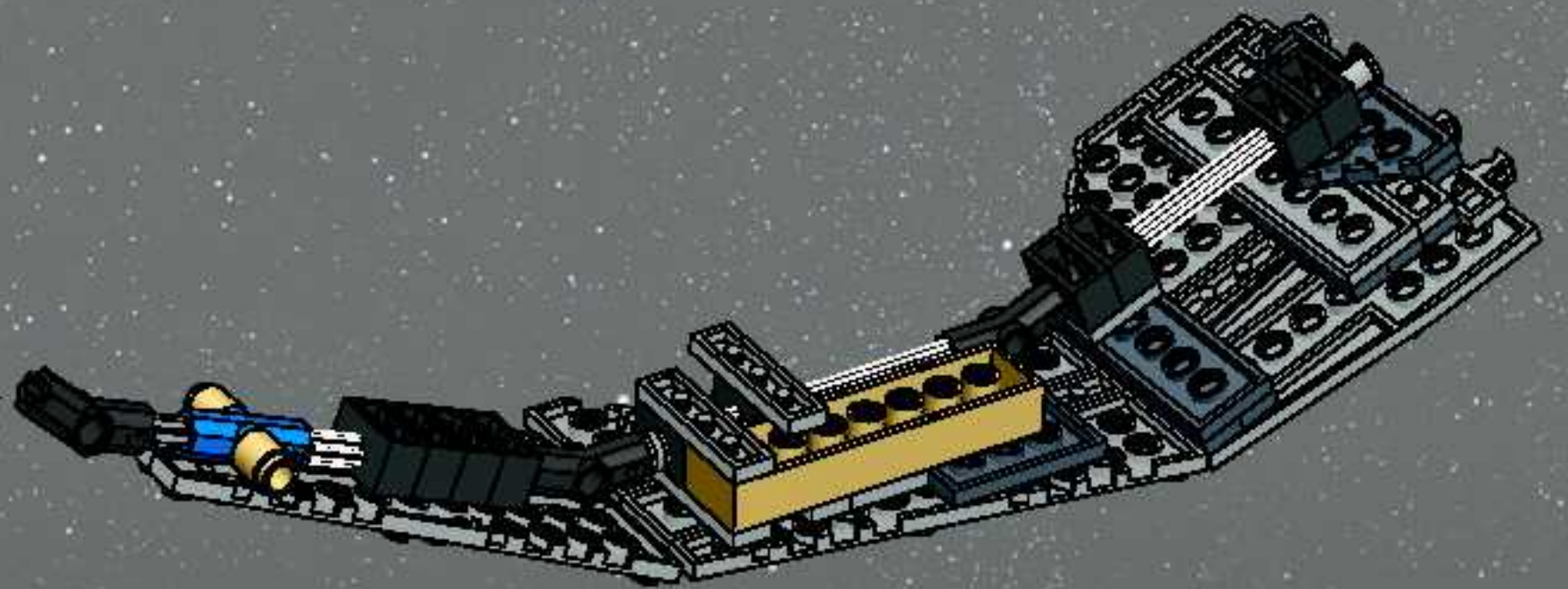
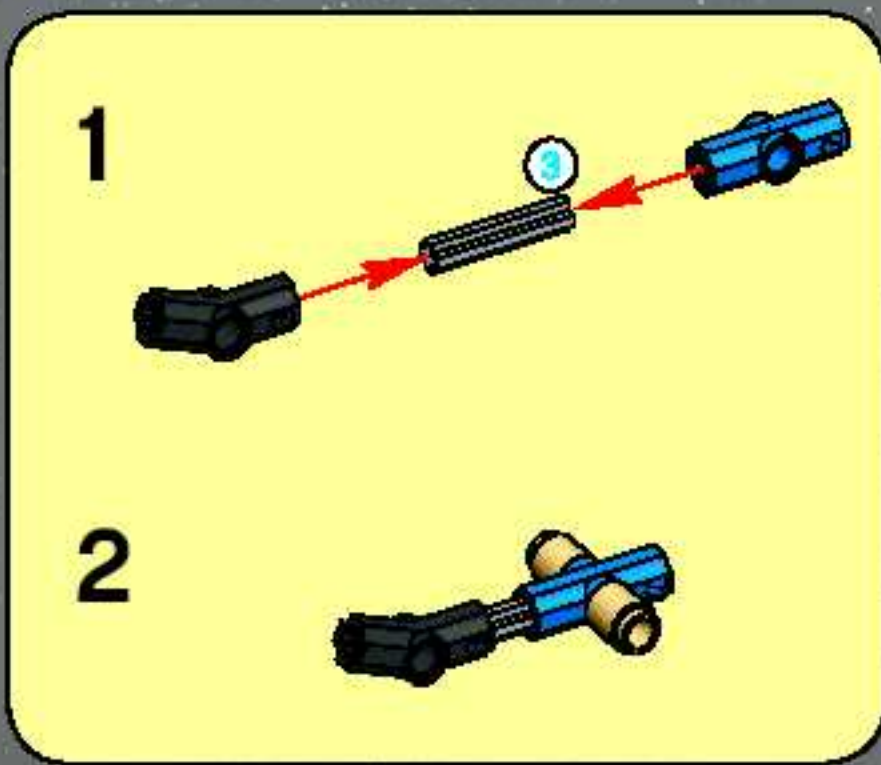



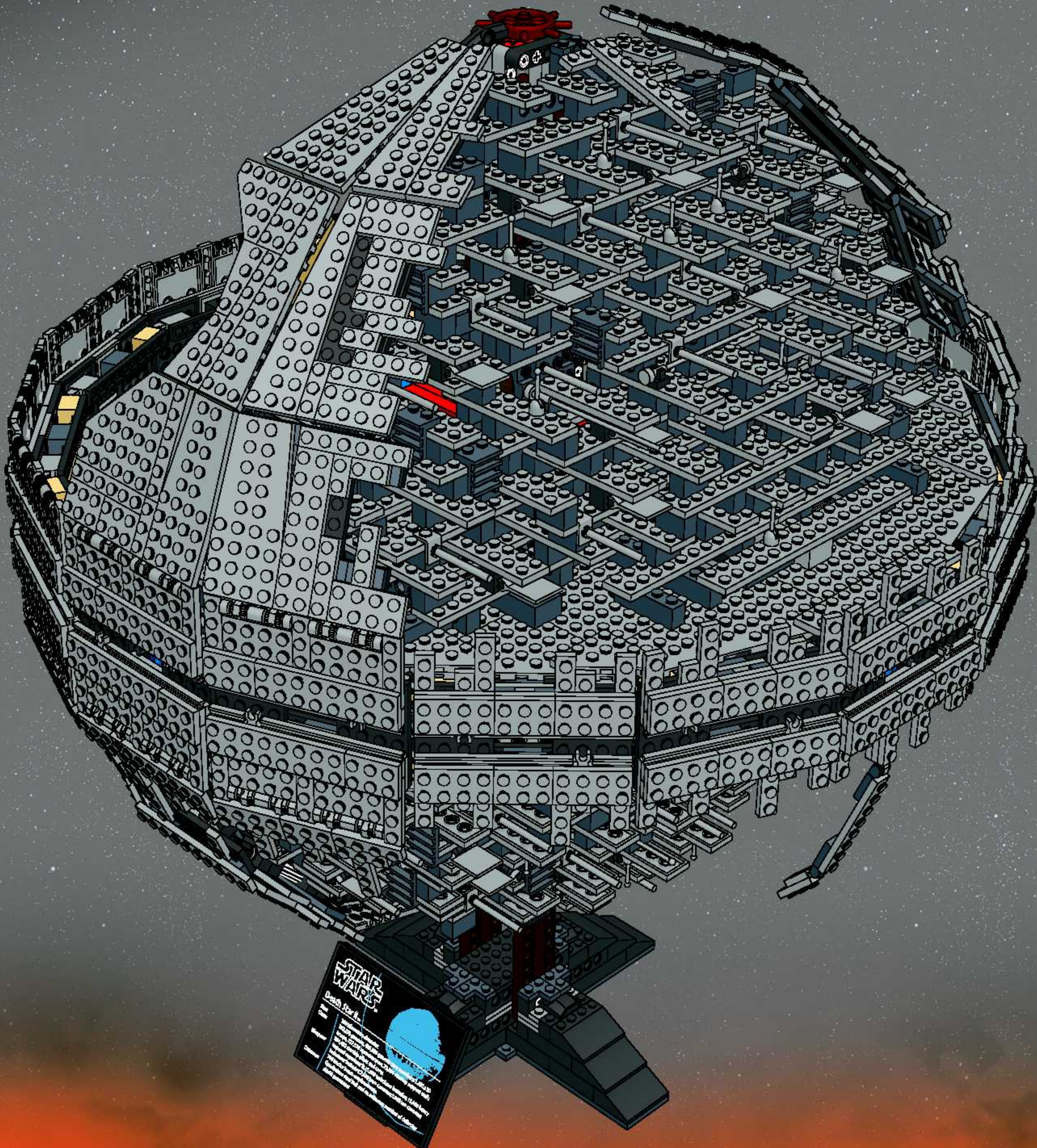



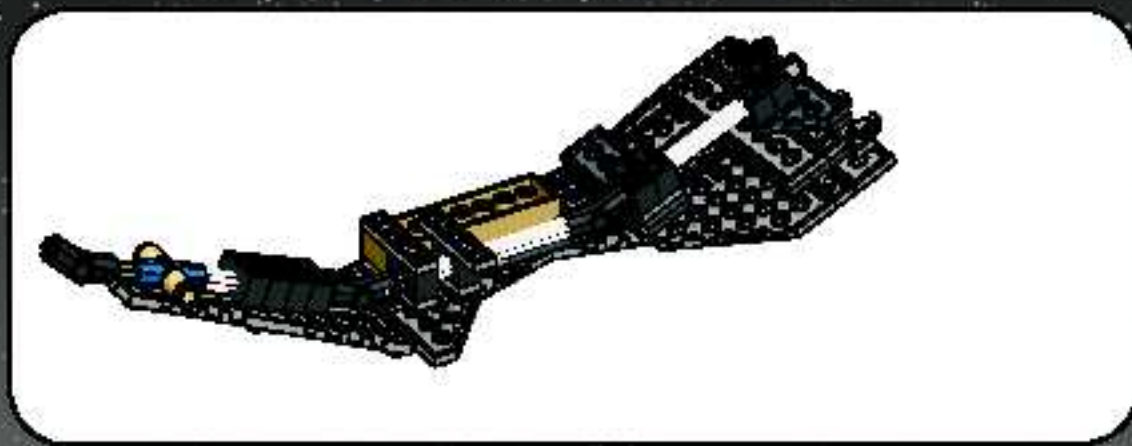

1



2

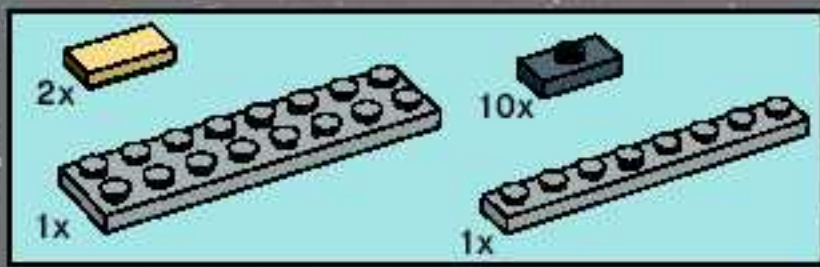

3

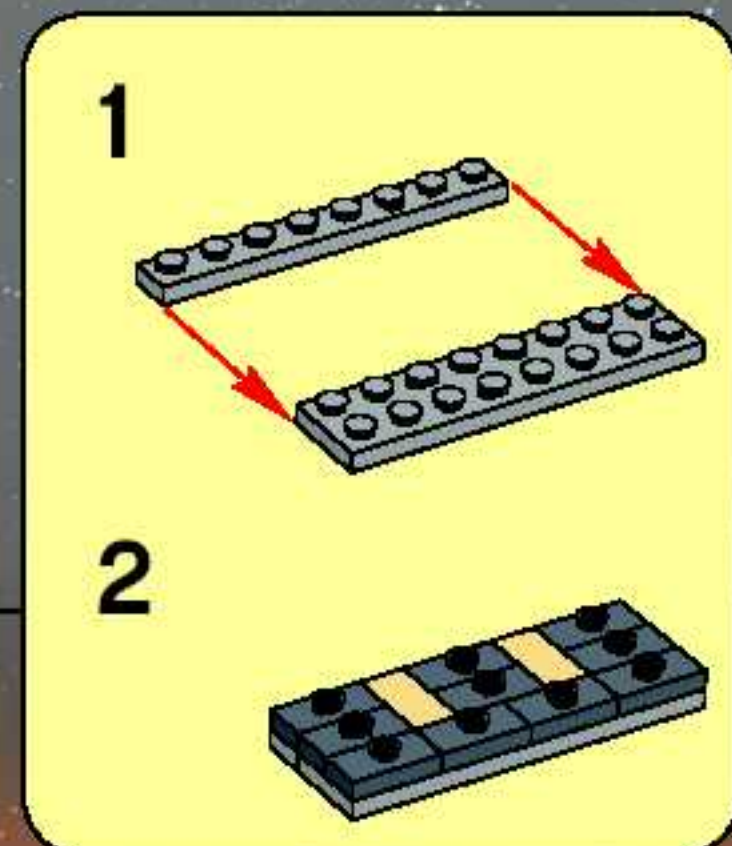
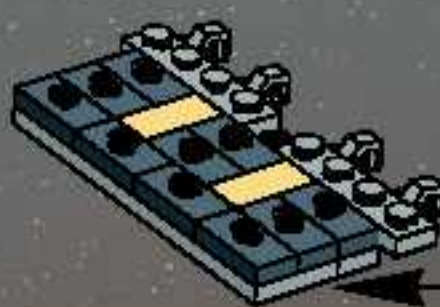



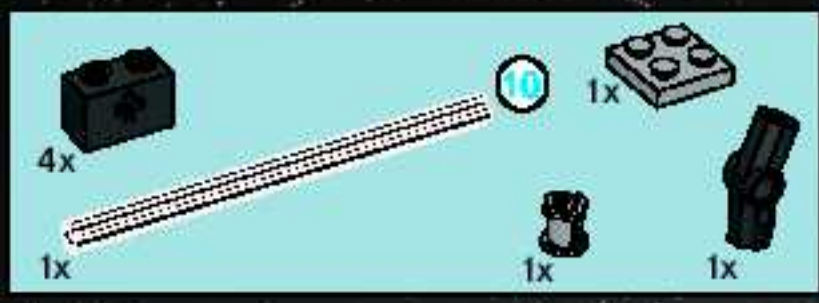

4

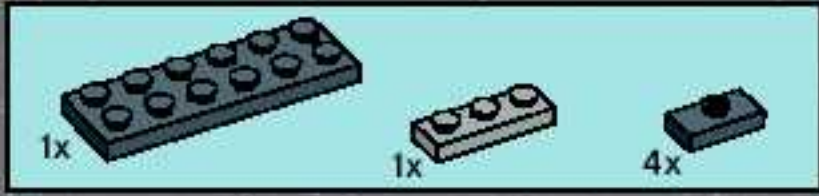
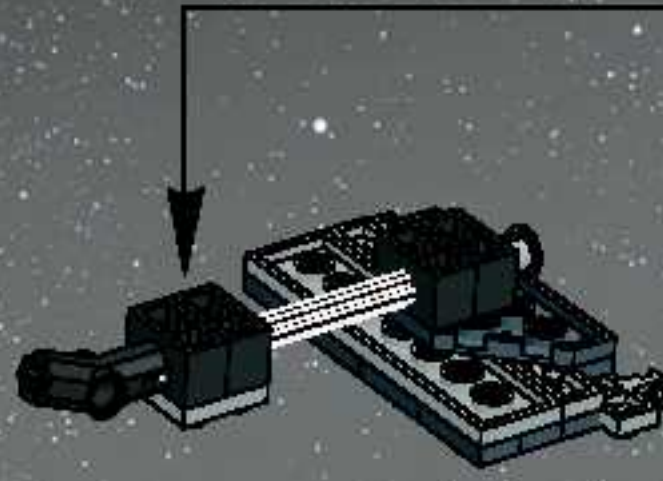
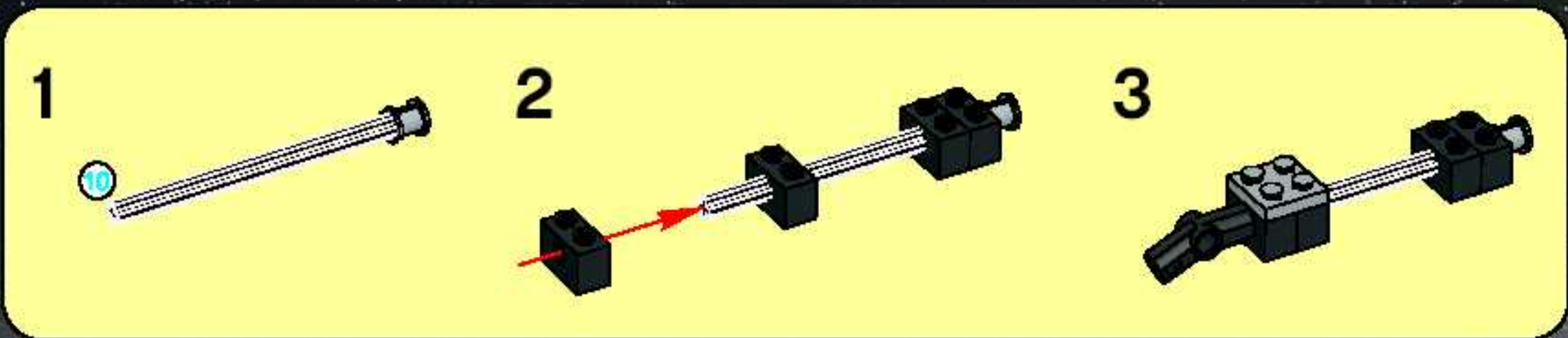

5

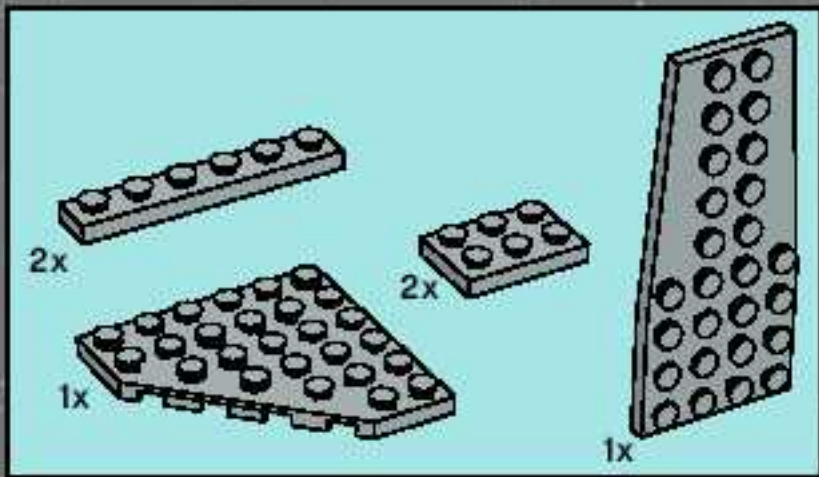
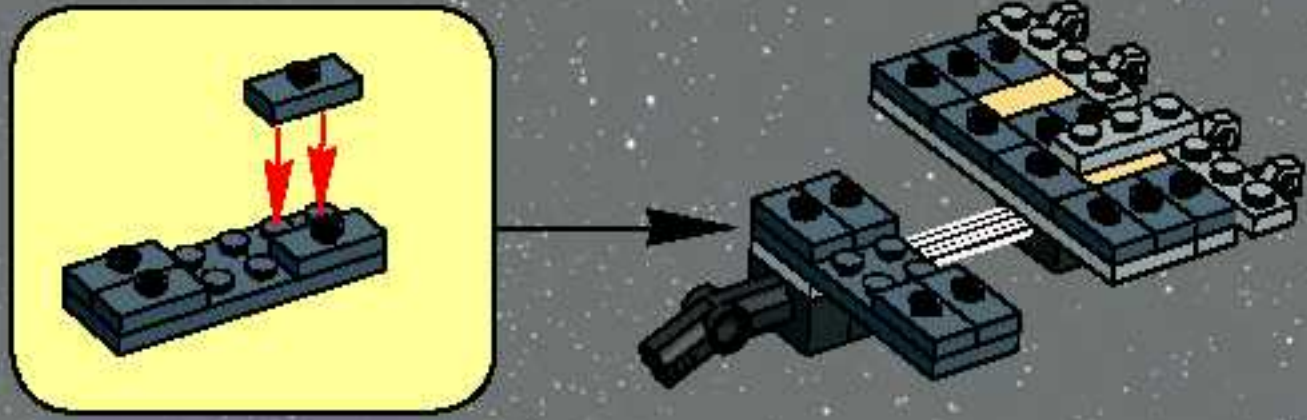

6

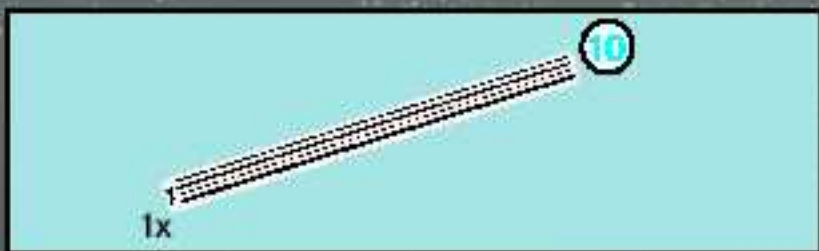

7

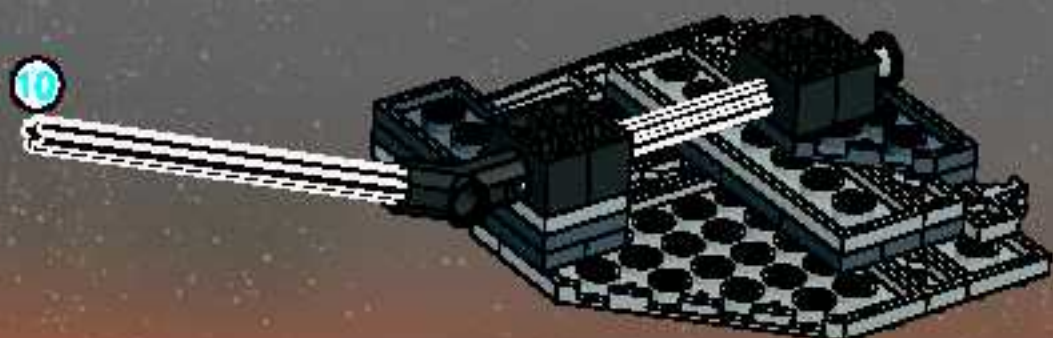







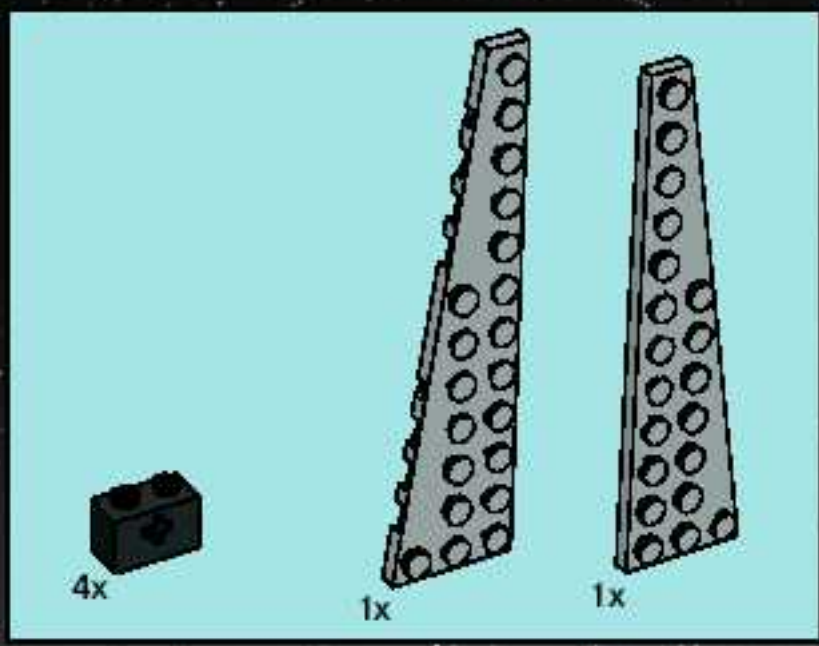

10

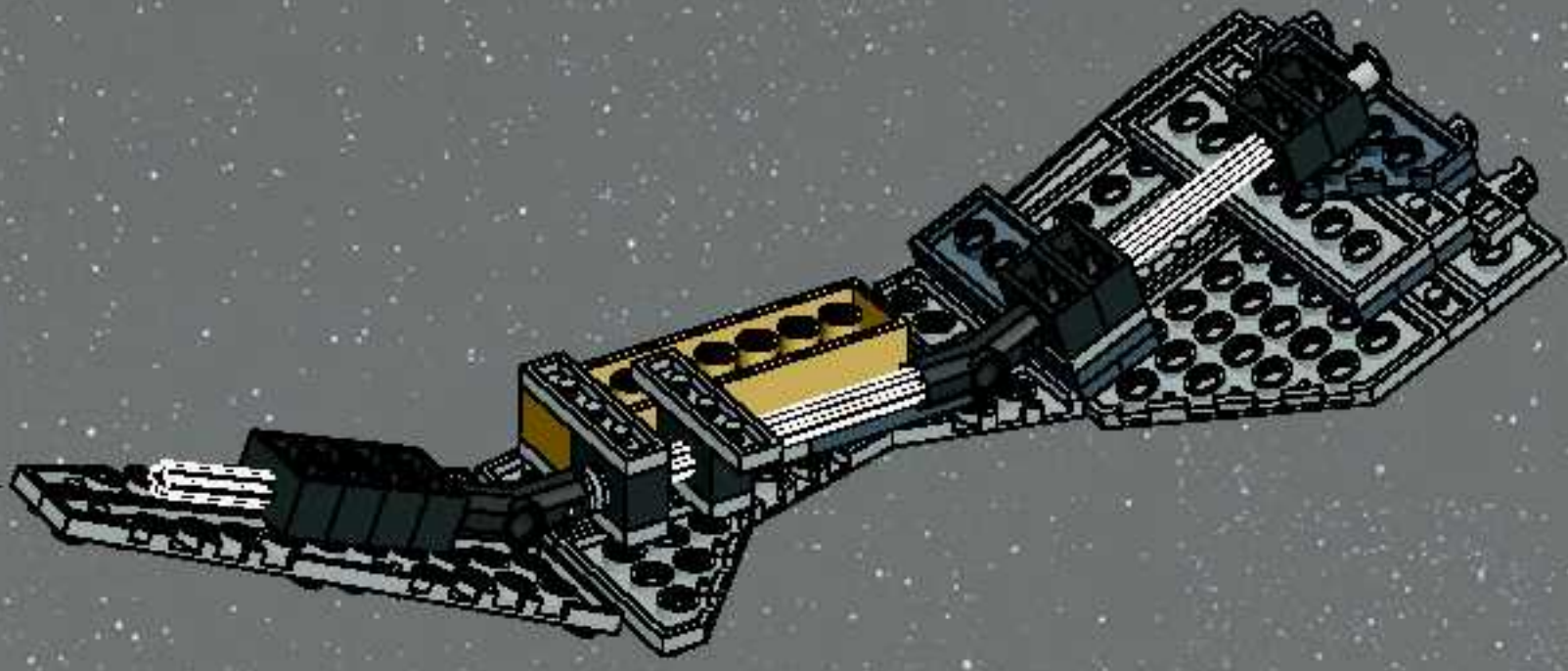
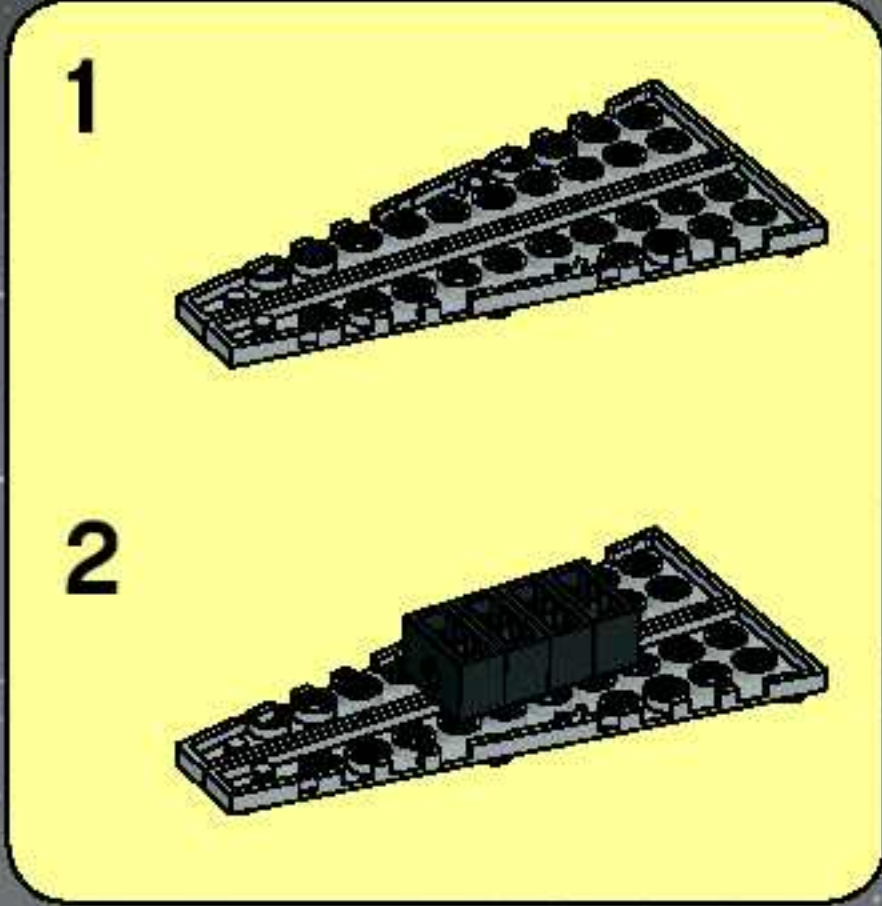

11

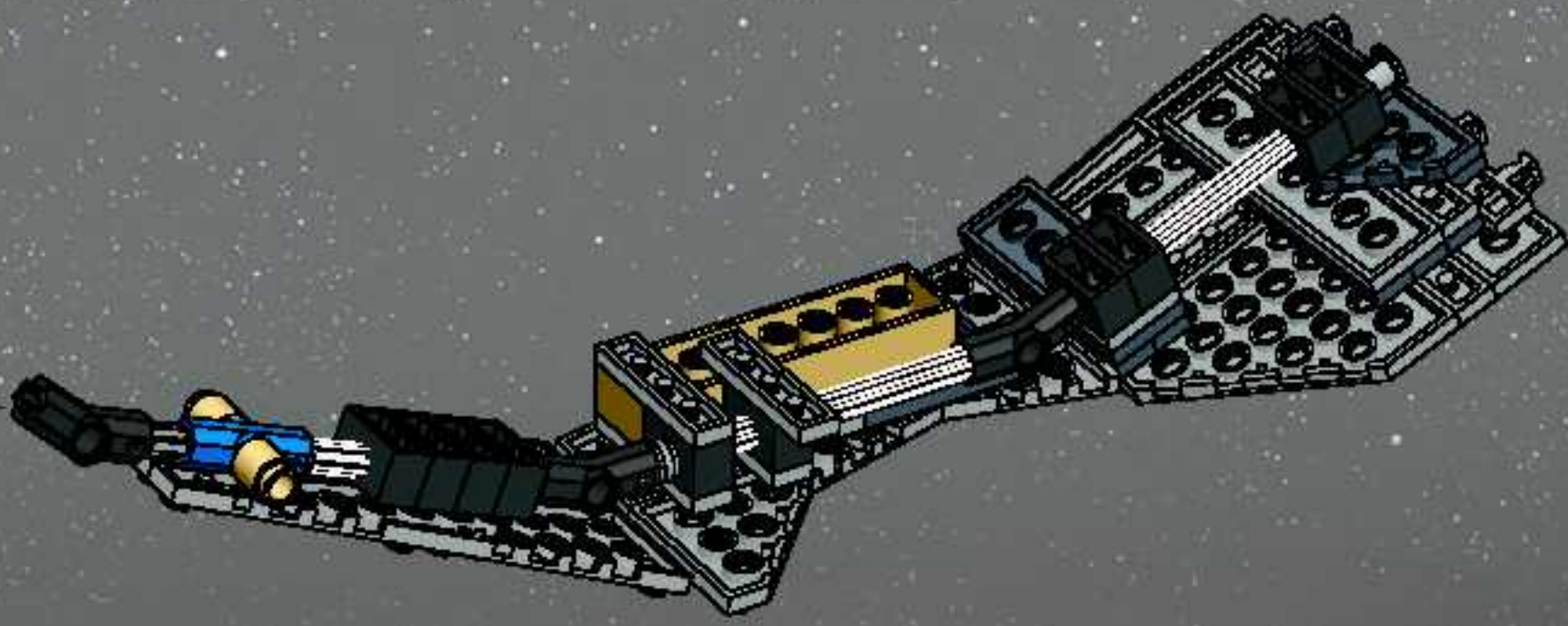
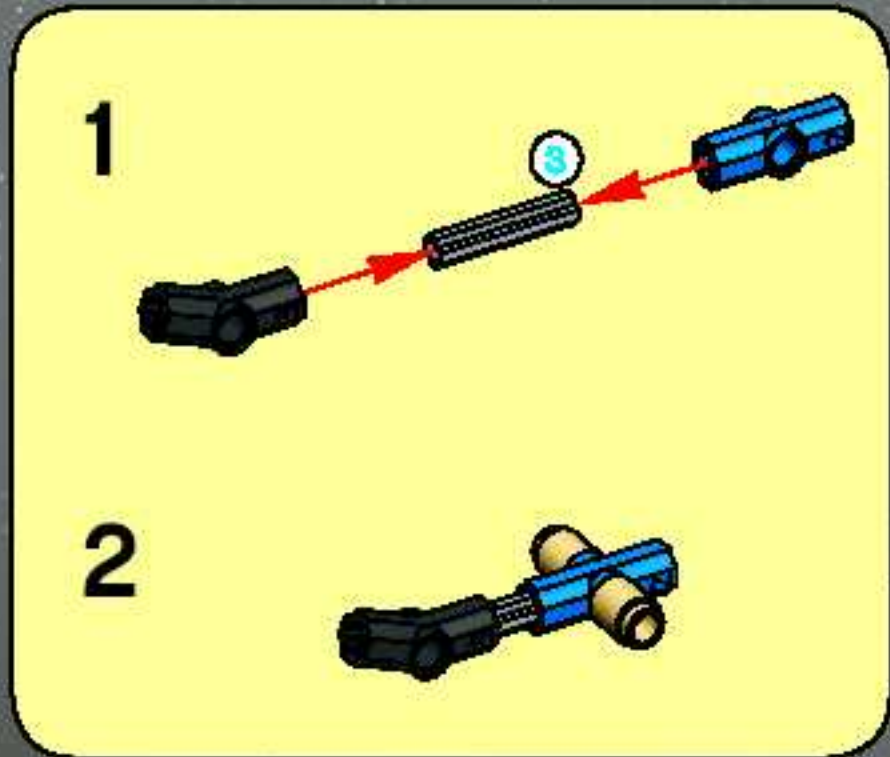



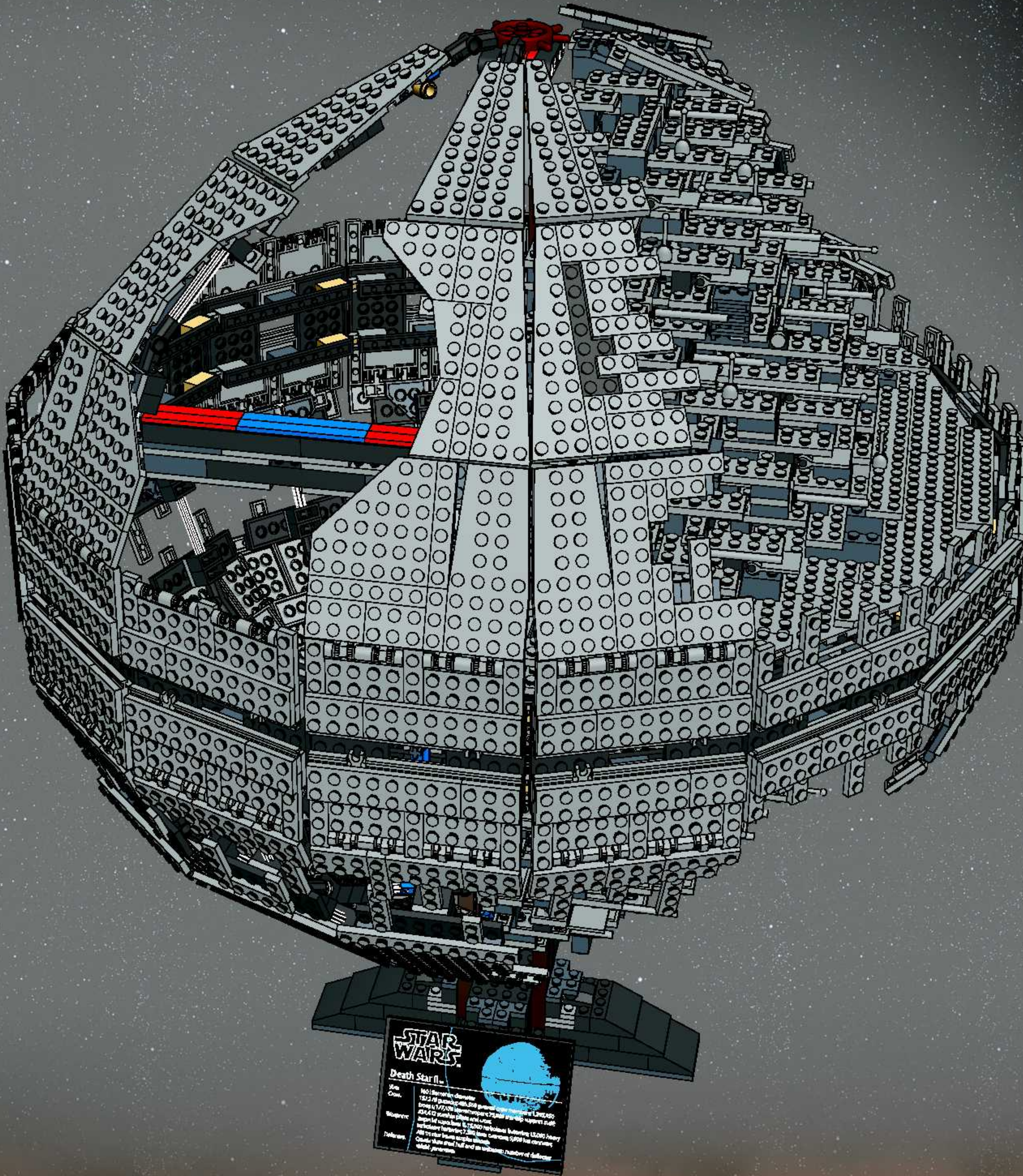



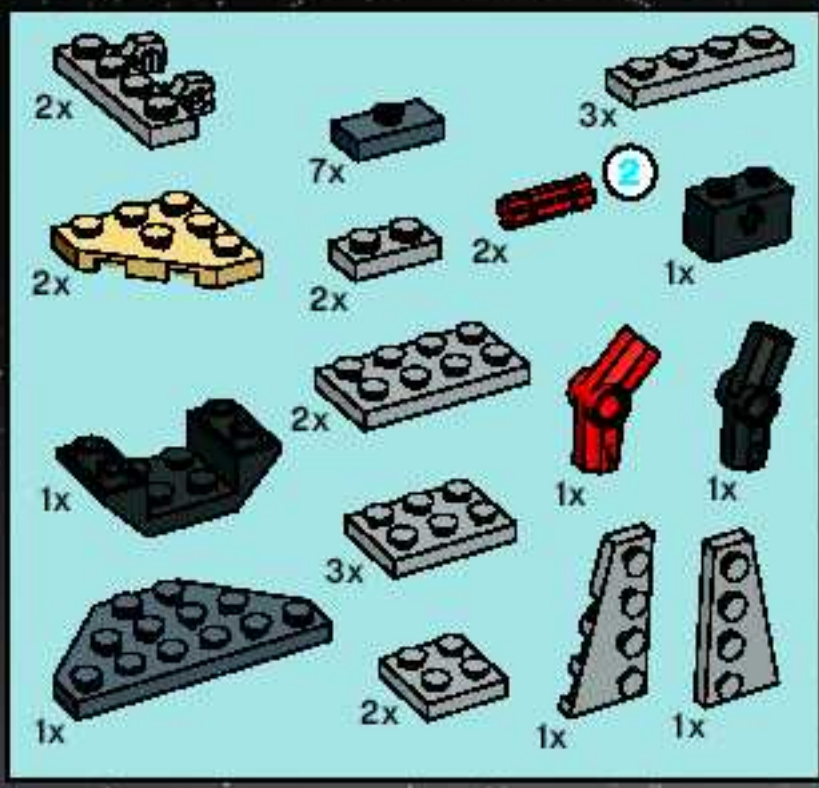

# 30

1



2

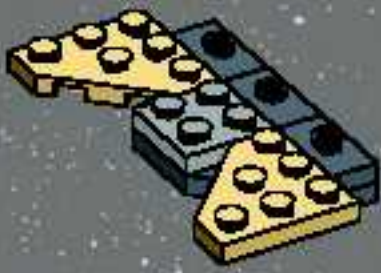

3

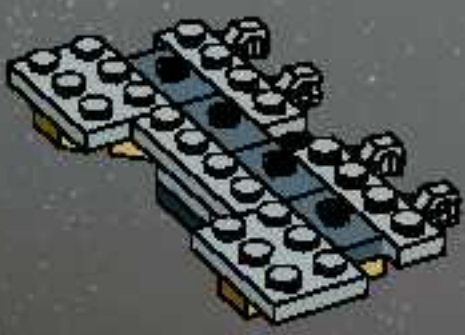

4

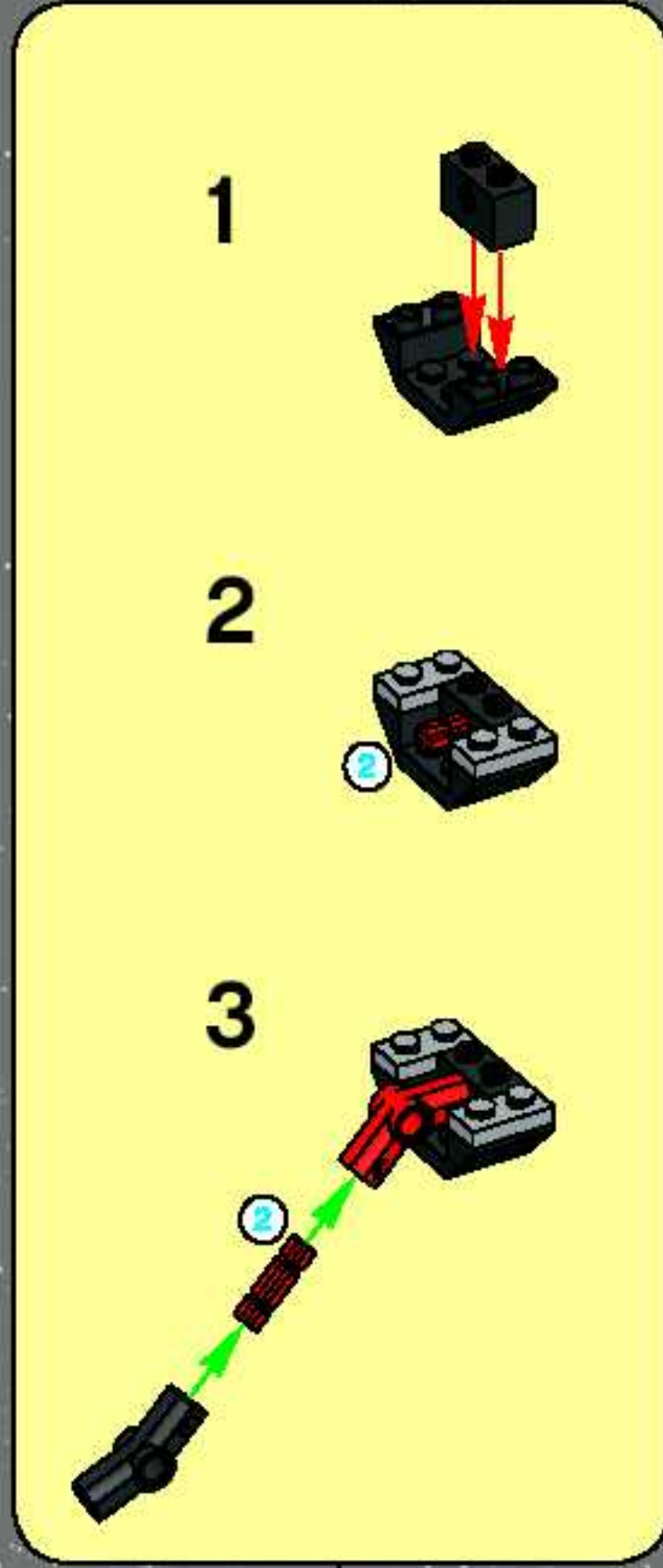
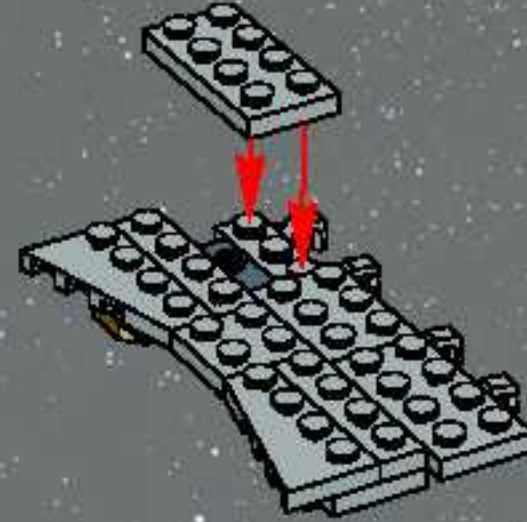

5





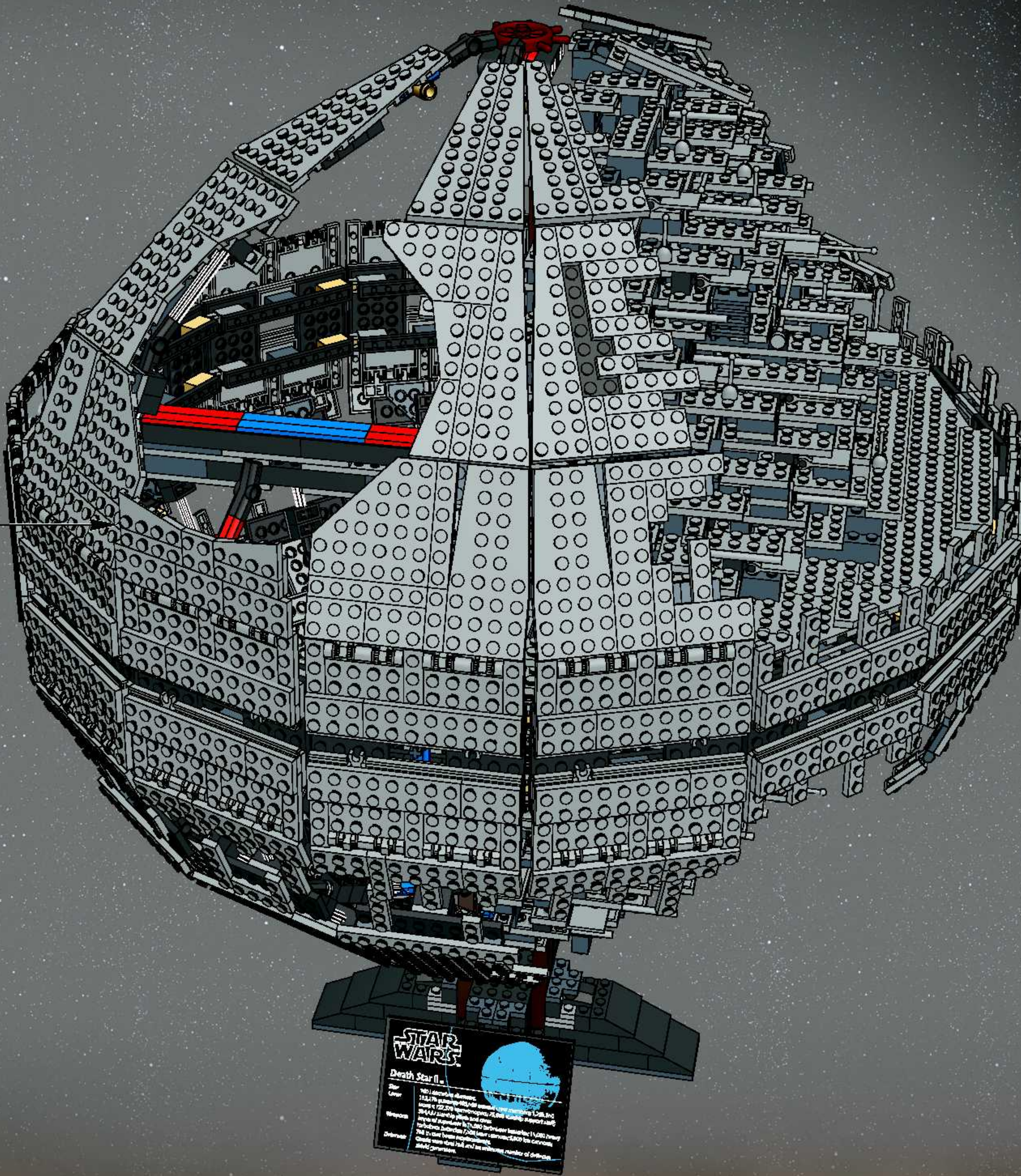



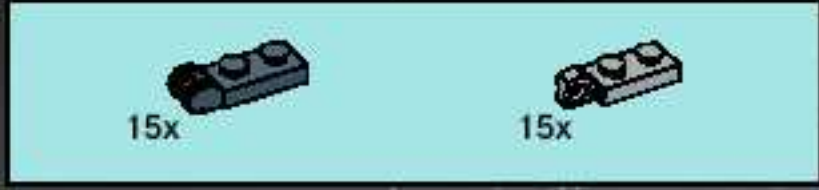
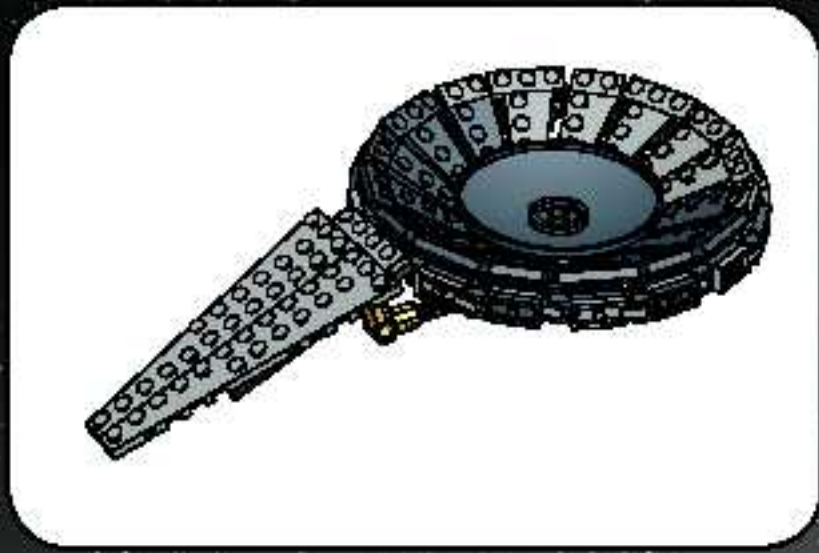

1

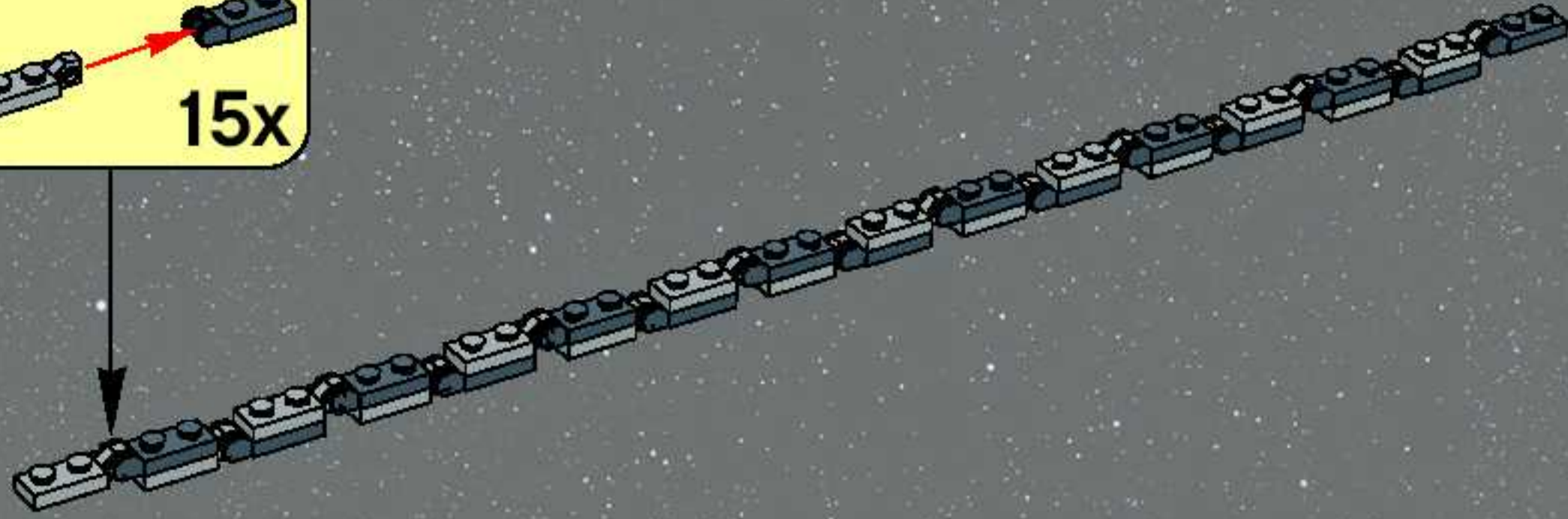
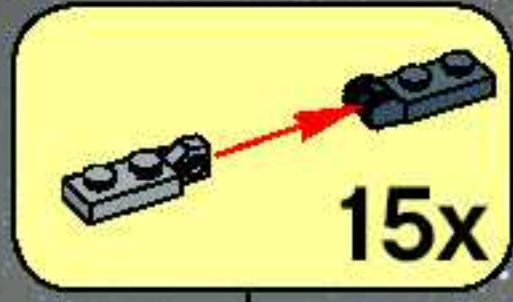

2

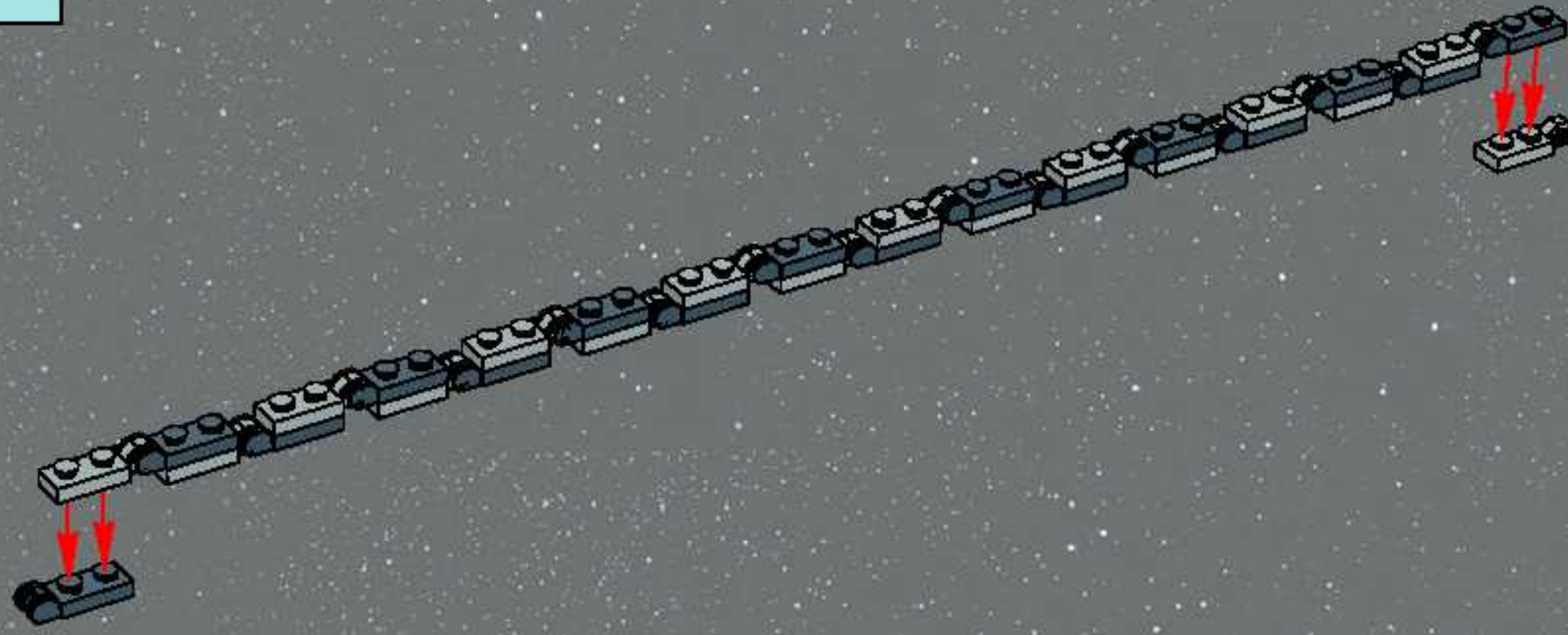

3

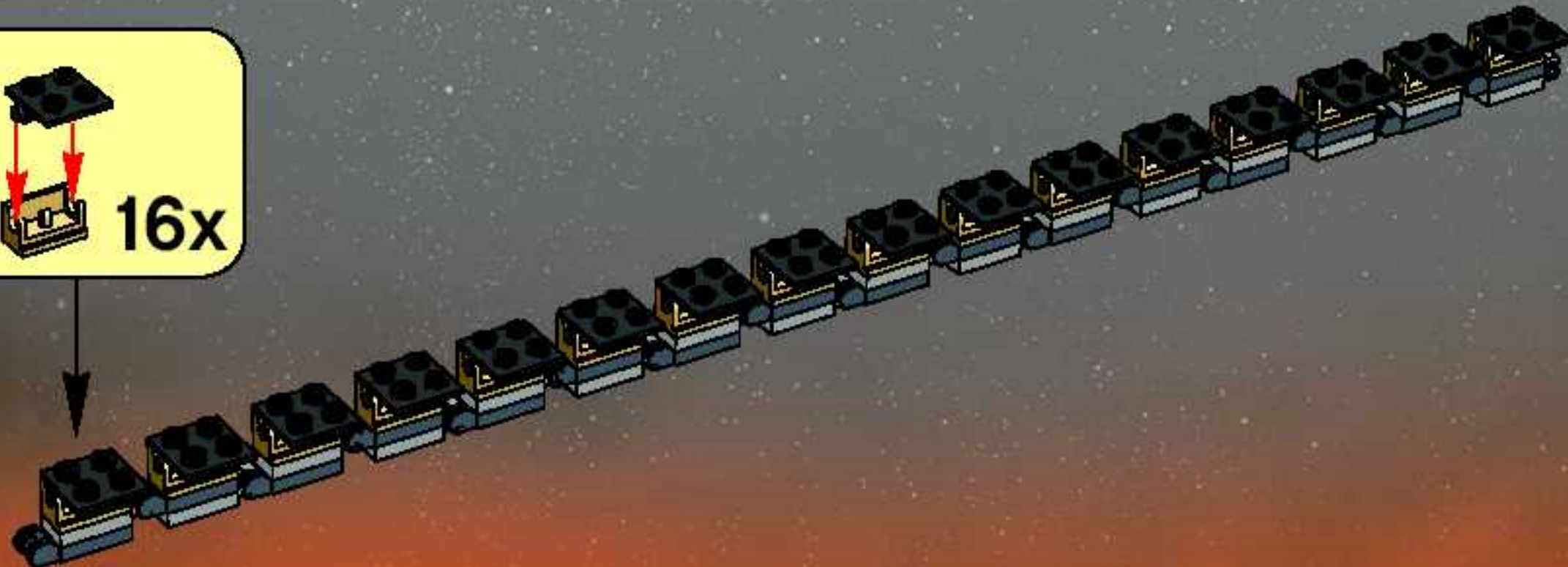



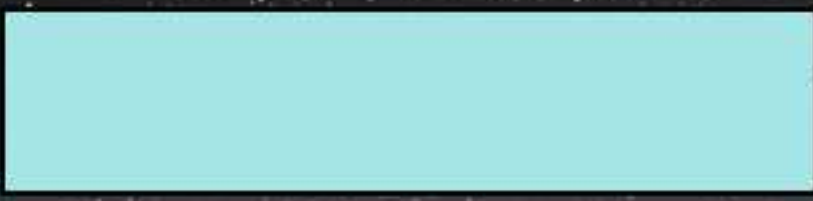

4

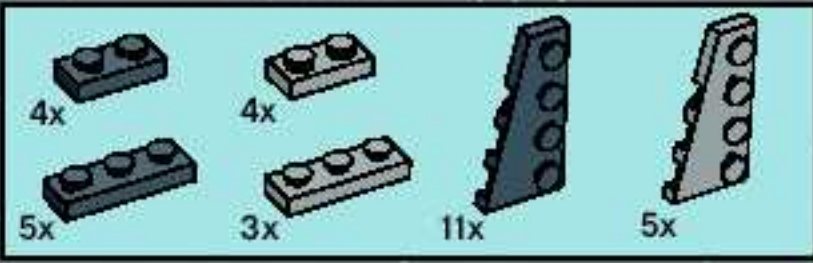

5



6

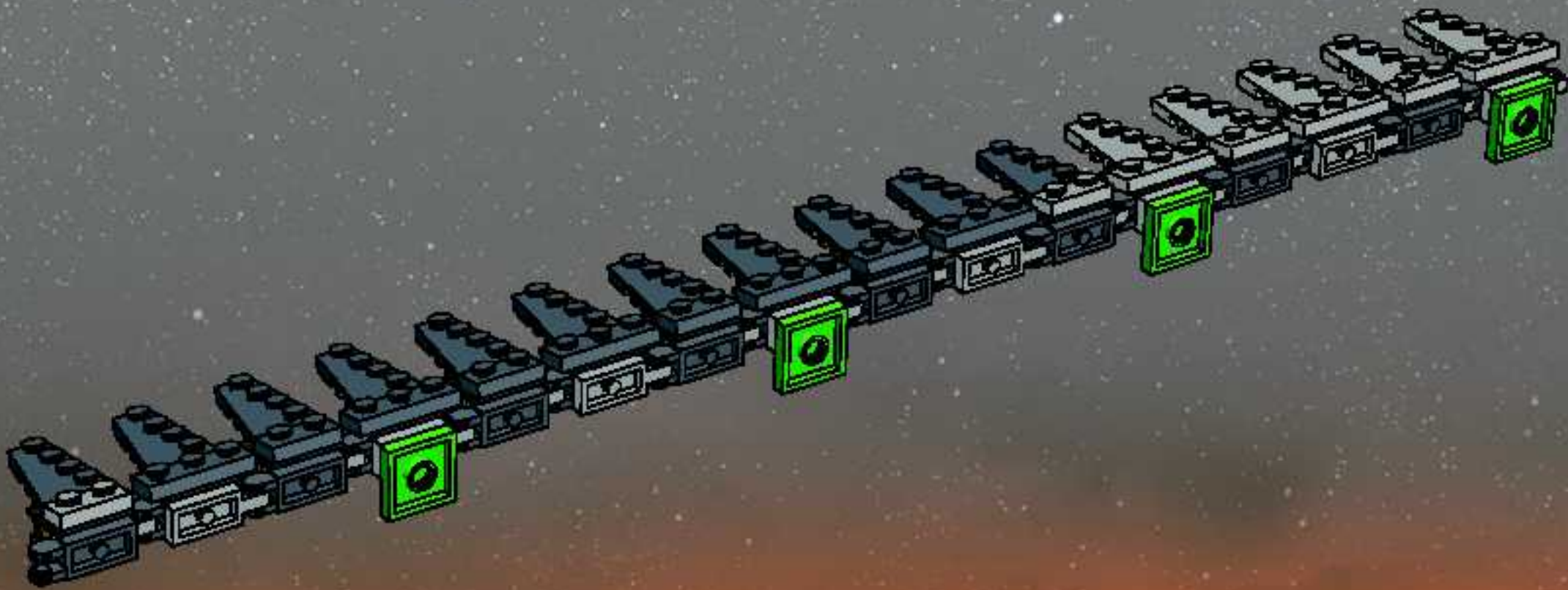





7

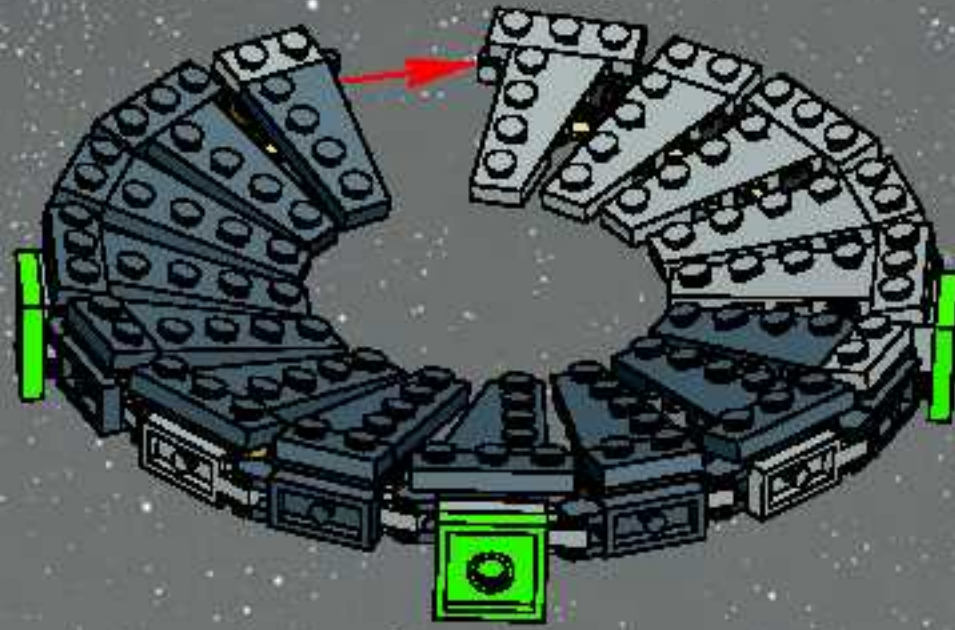

8

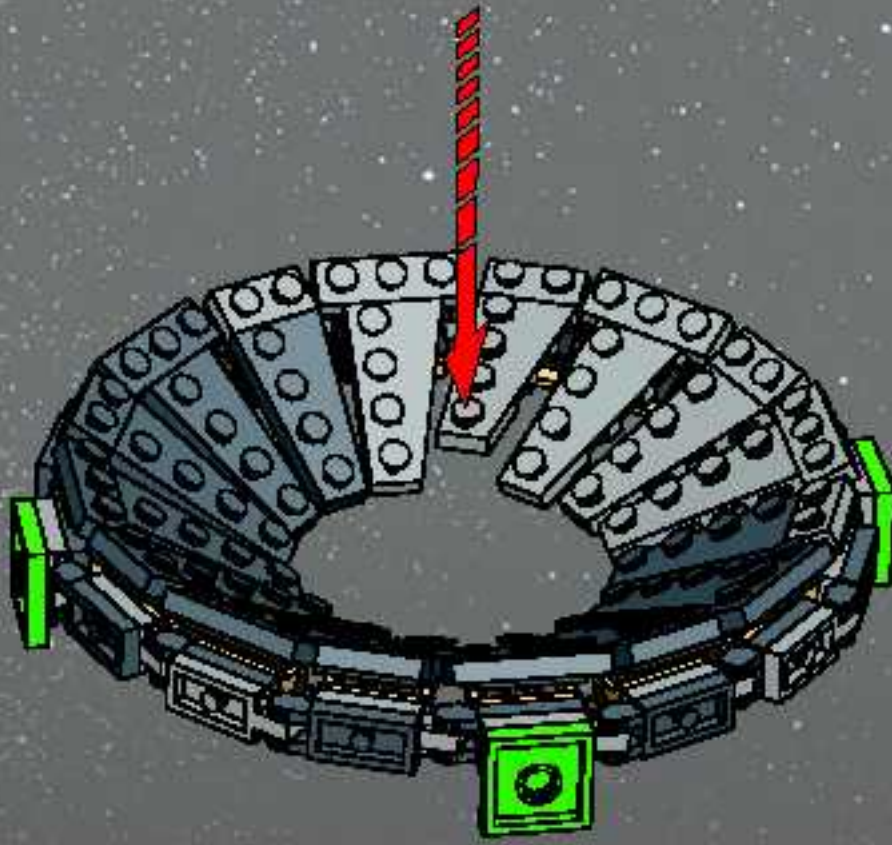







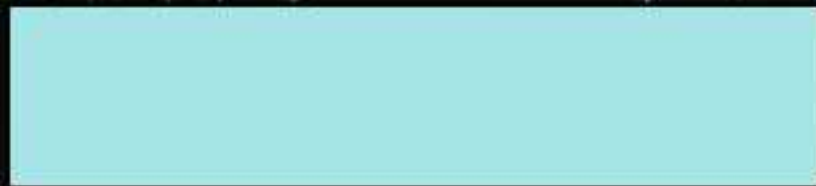

10

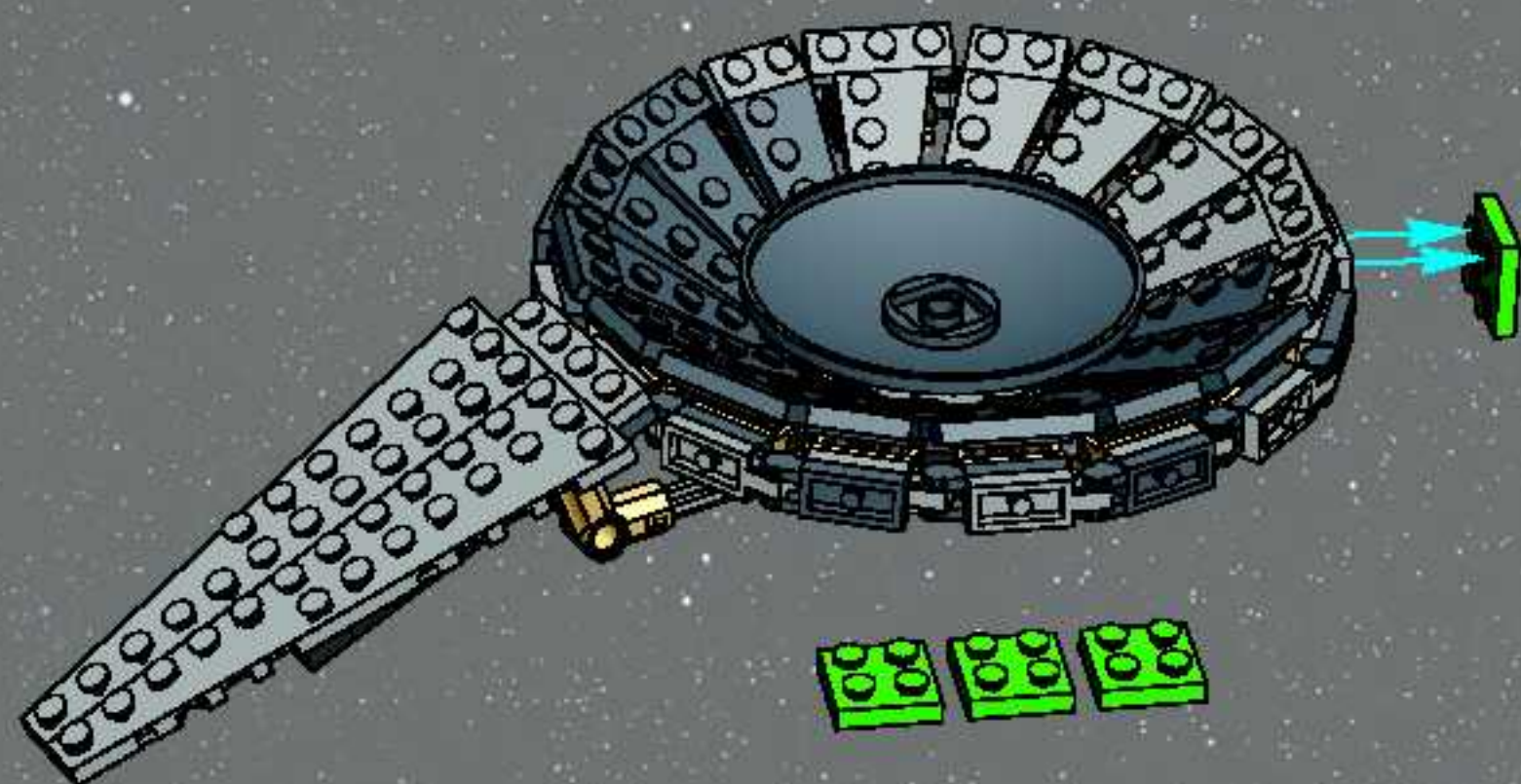











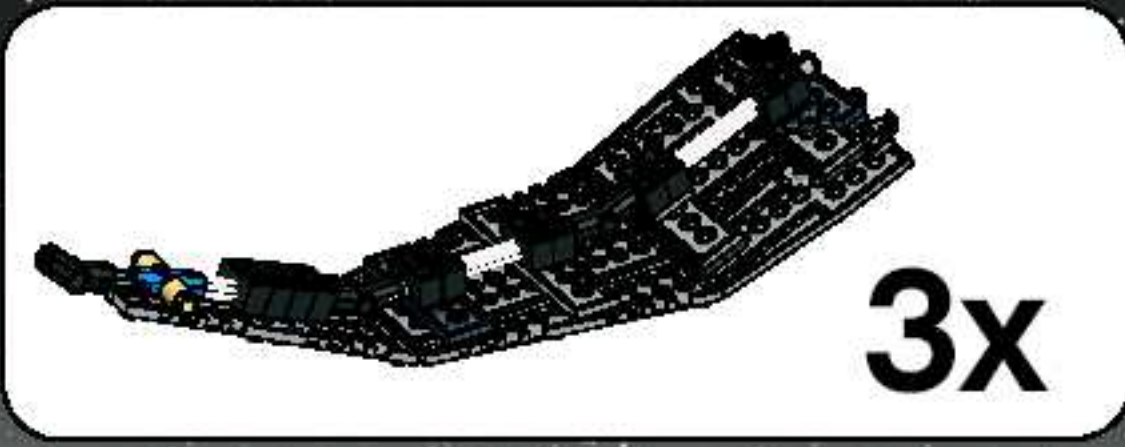

1

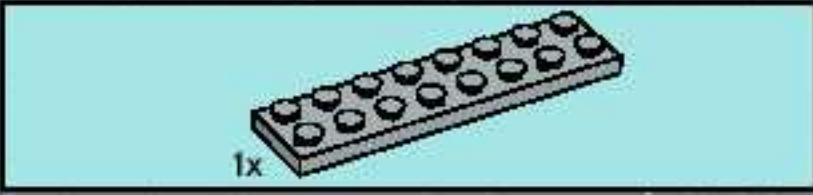

2



3

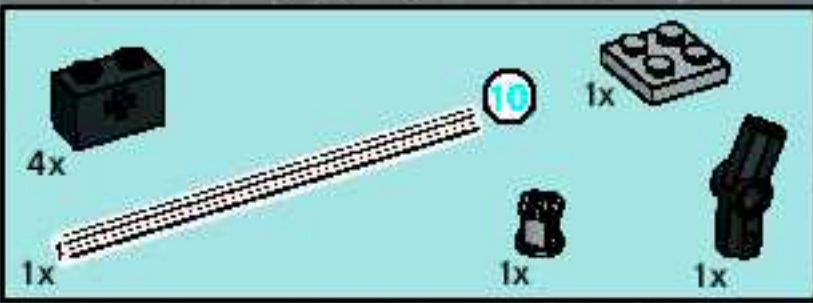
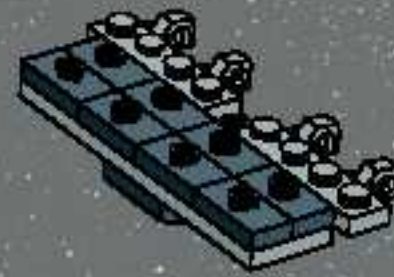

4

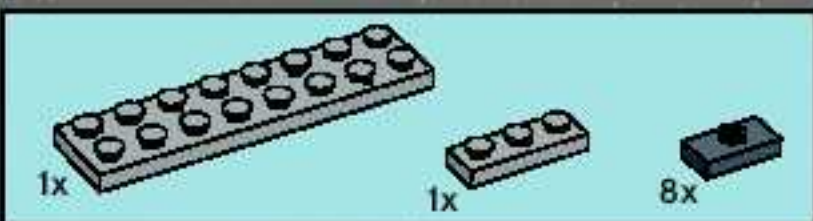
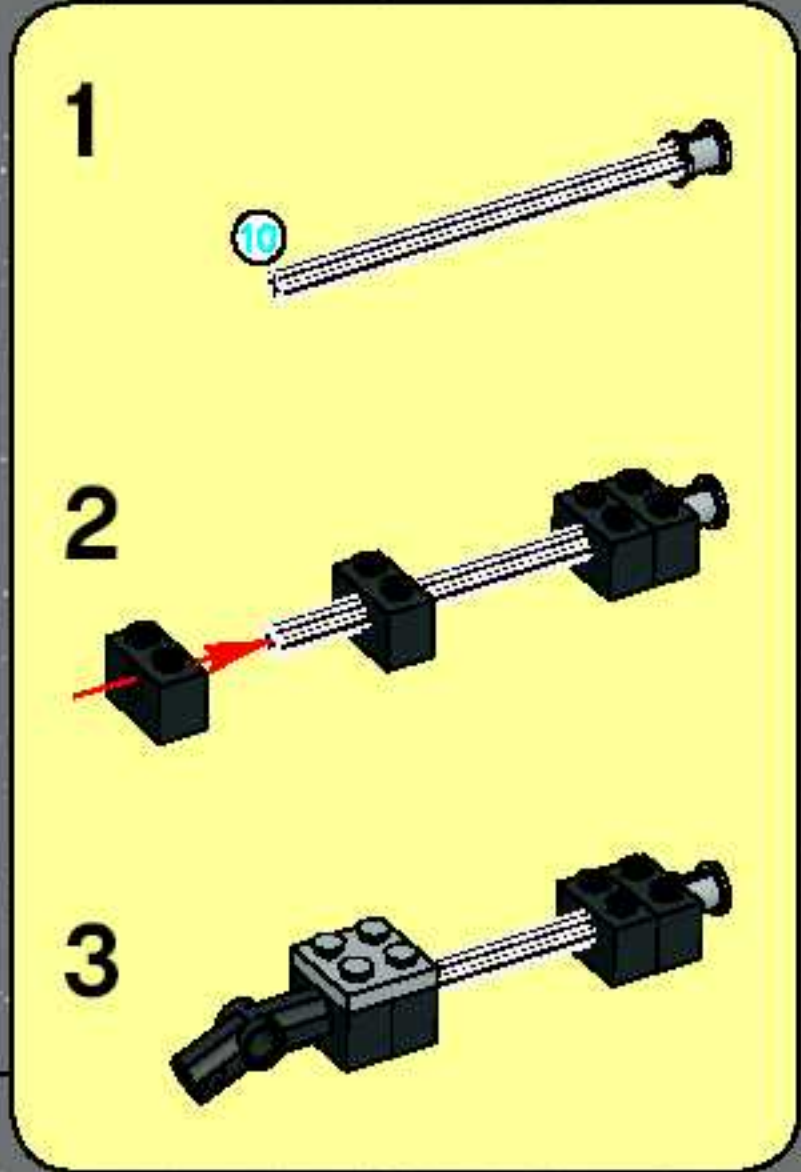
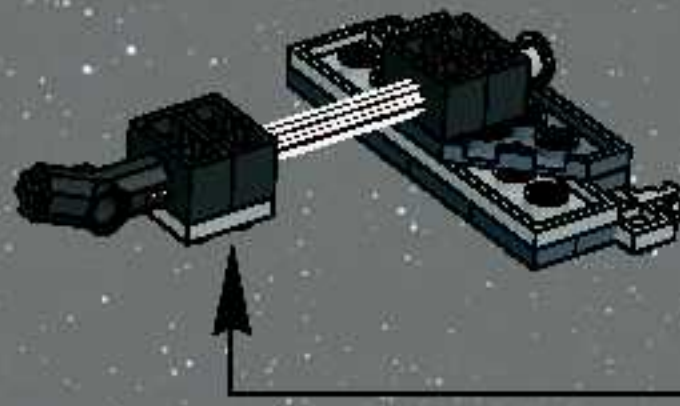

5

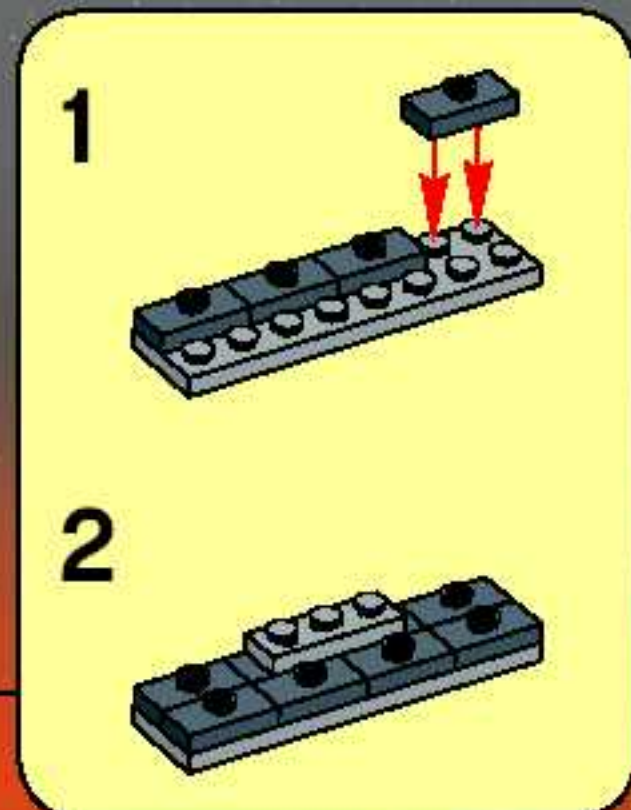
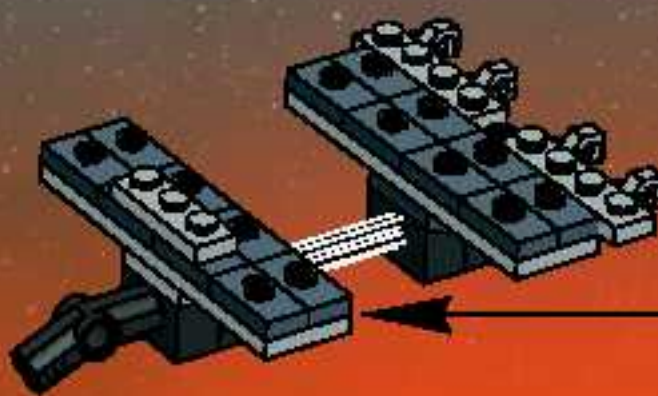



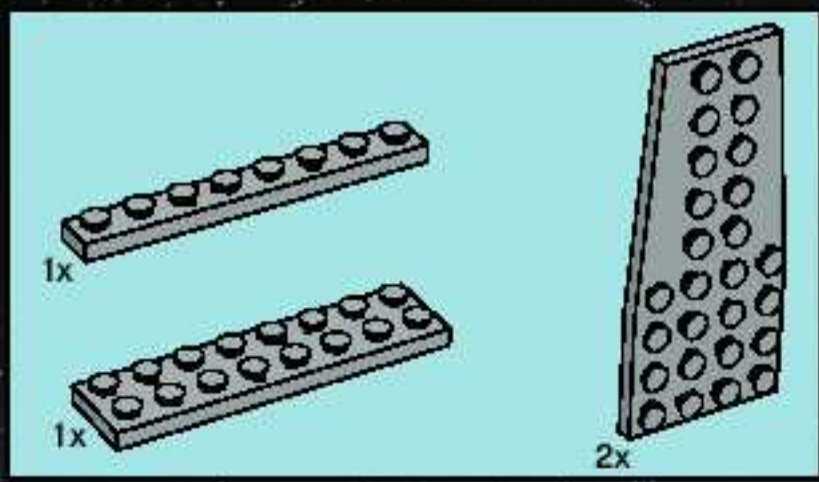

6

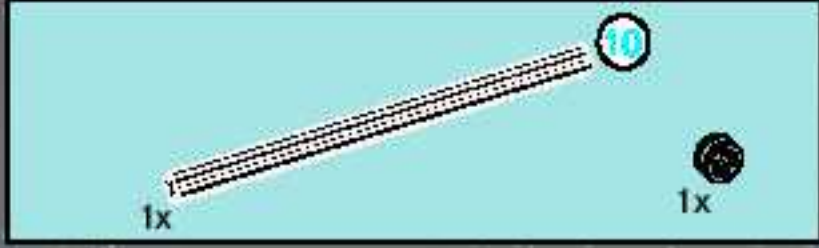

7

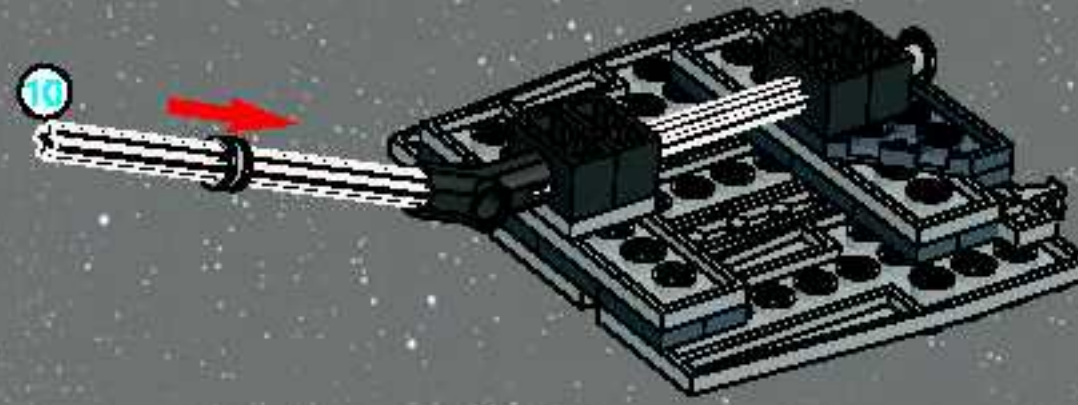

8

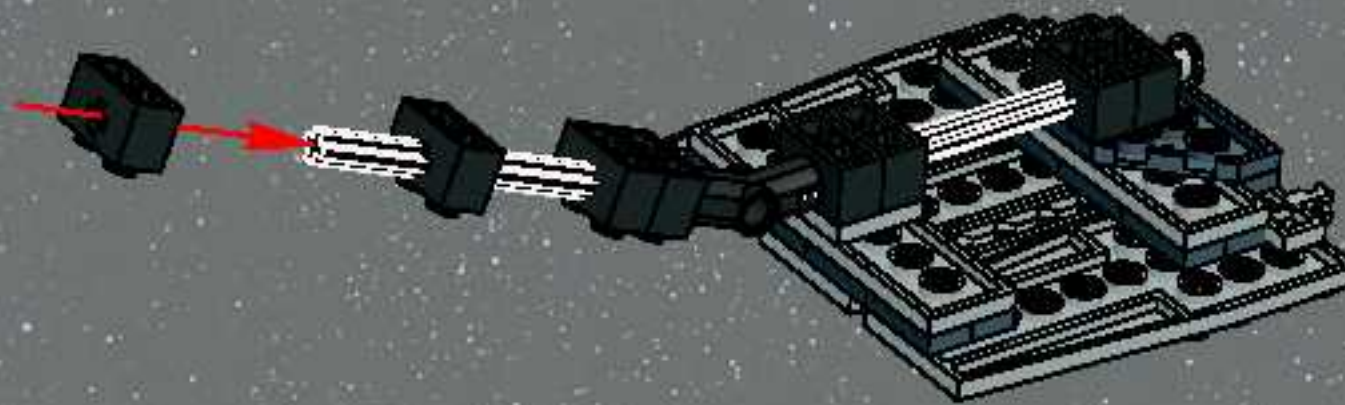

9

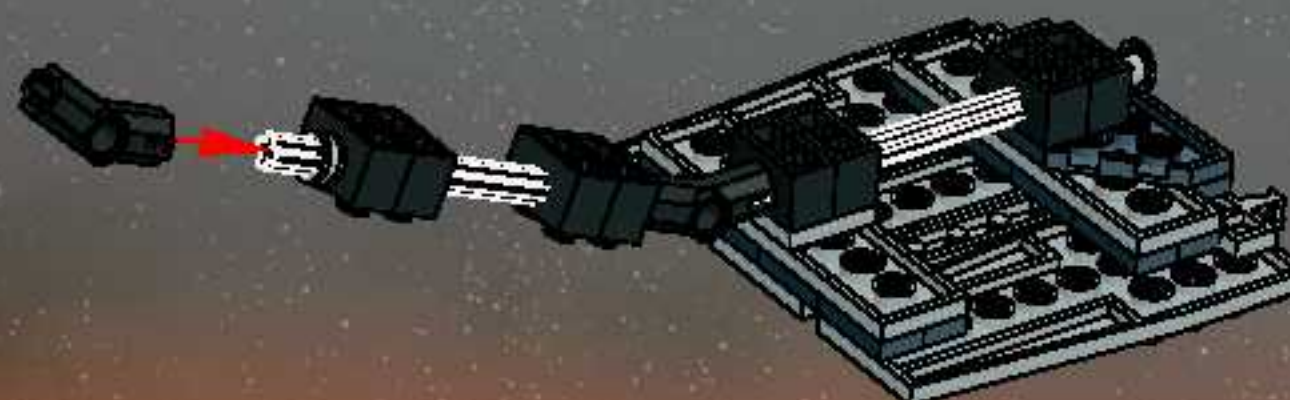



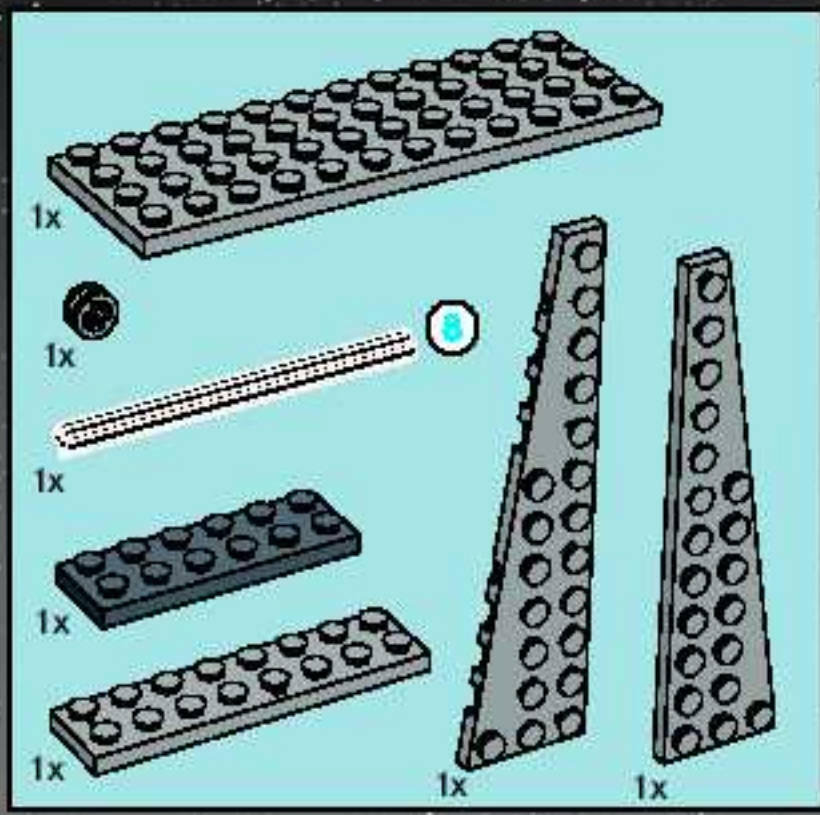

10

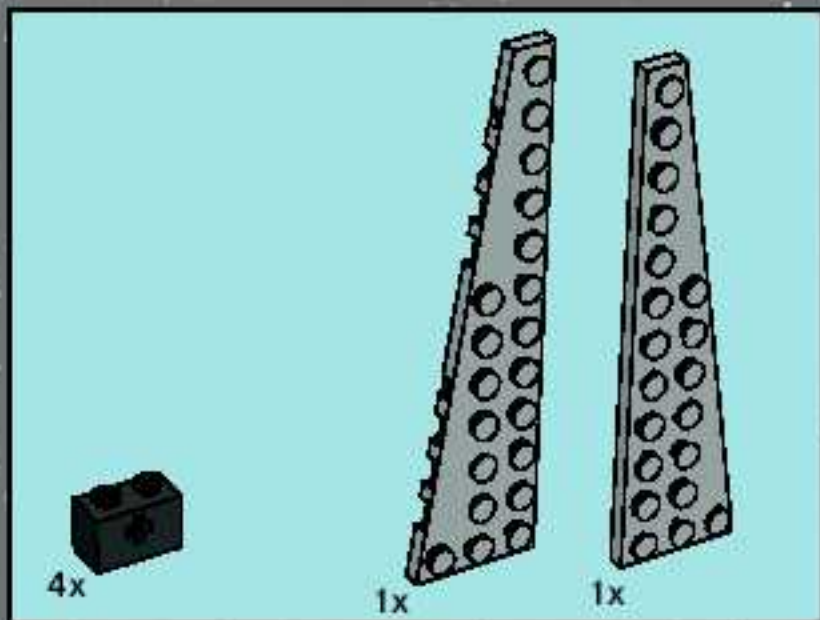
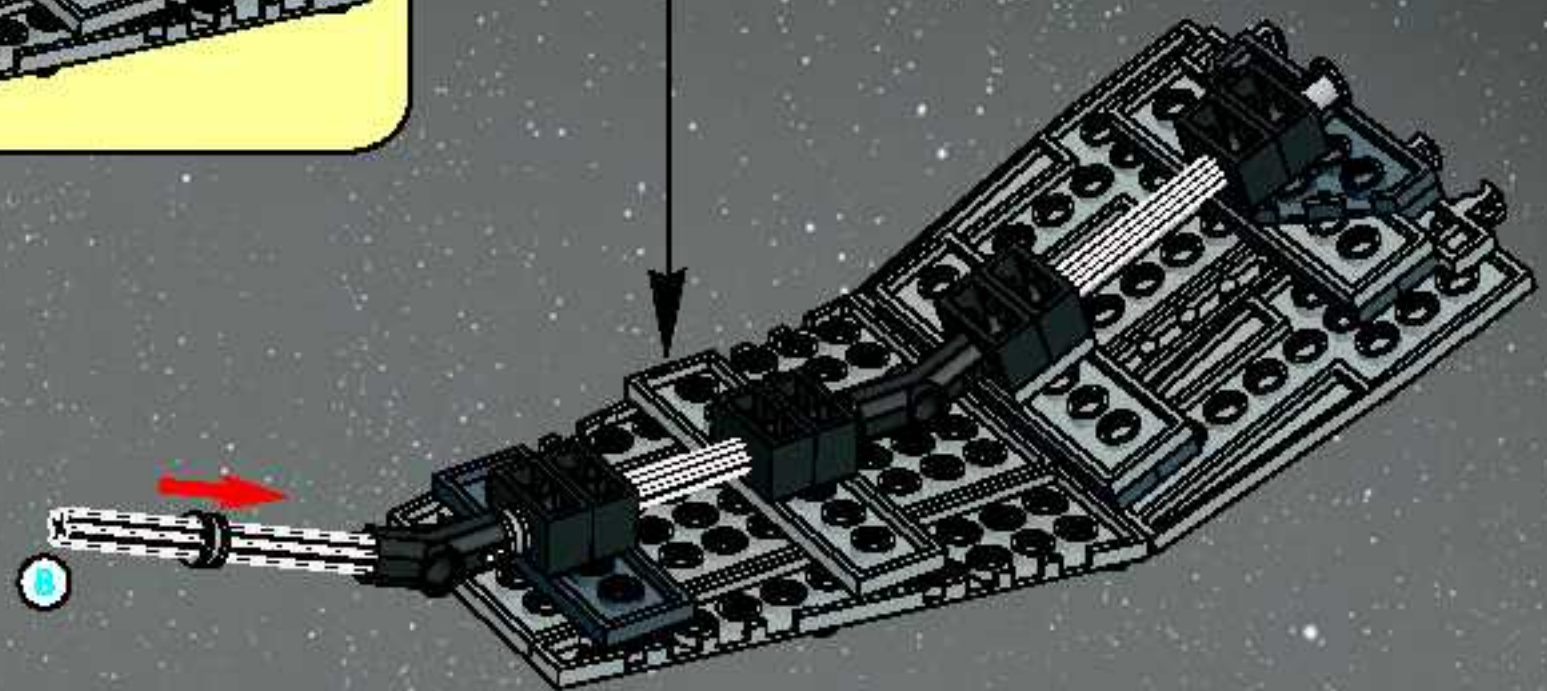
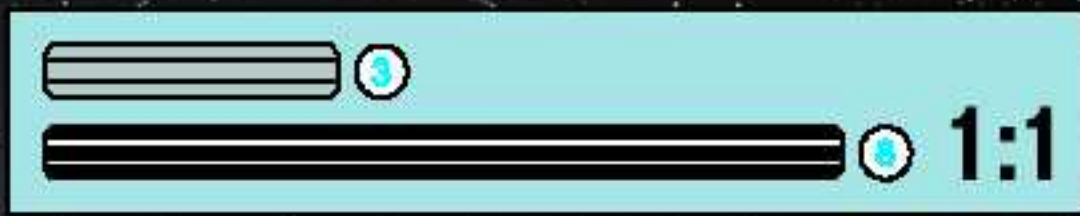
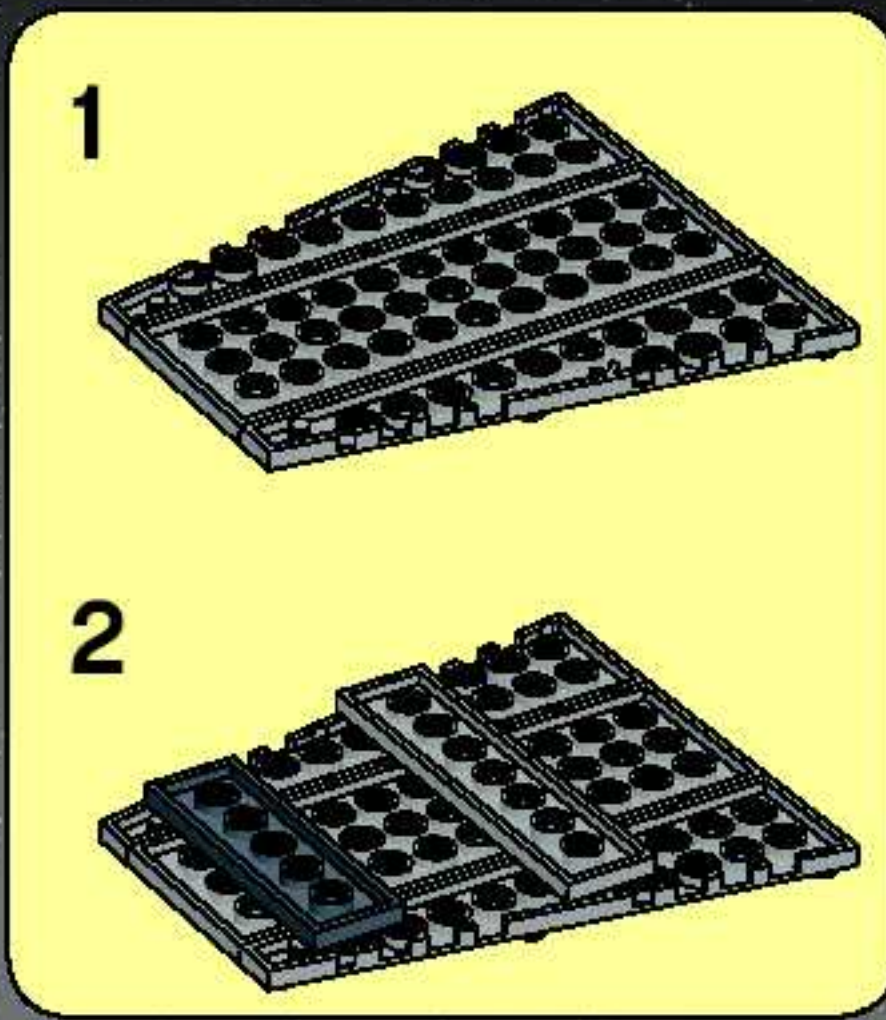

11

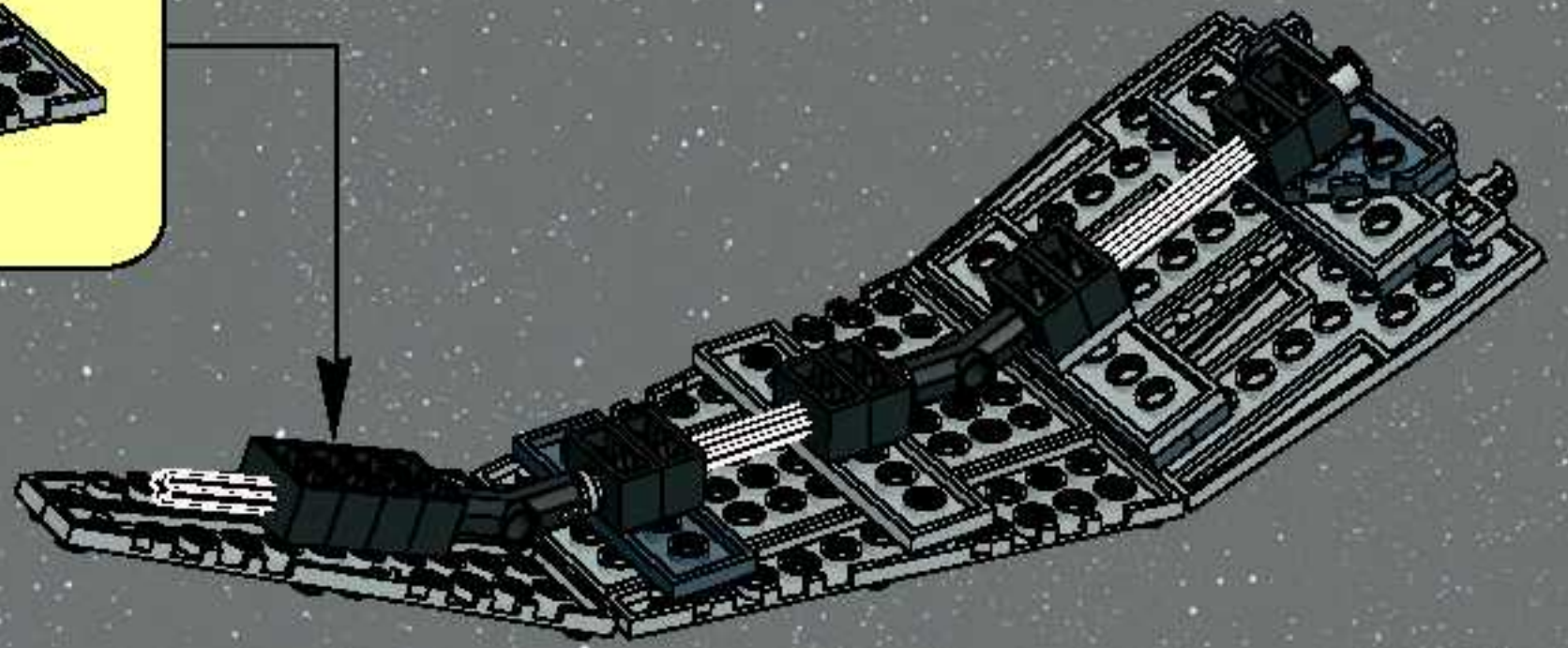
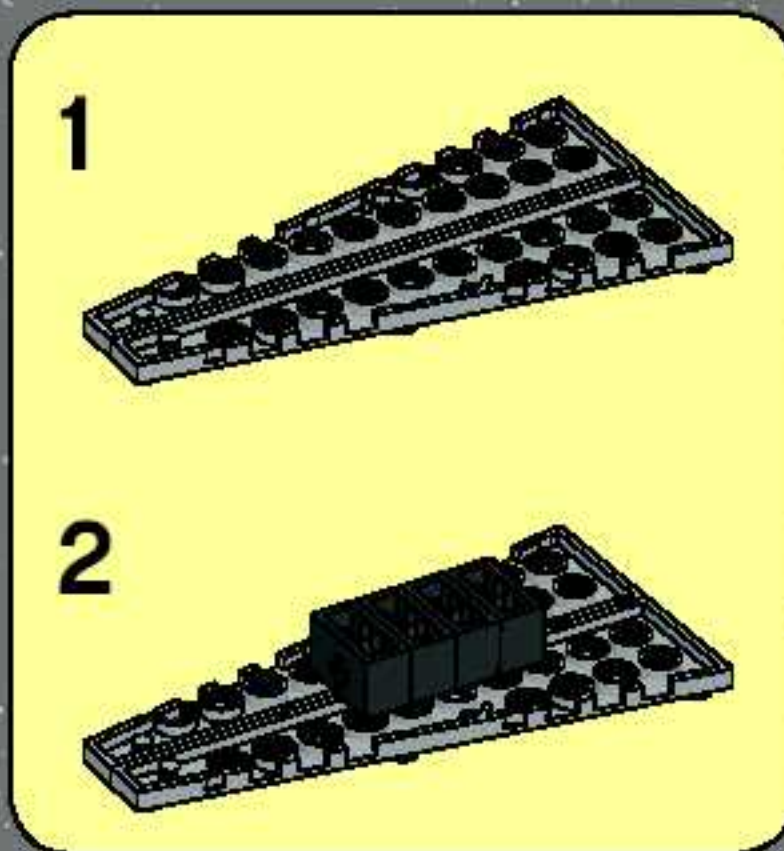

12

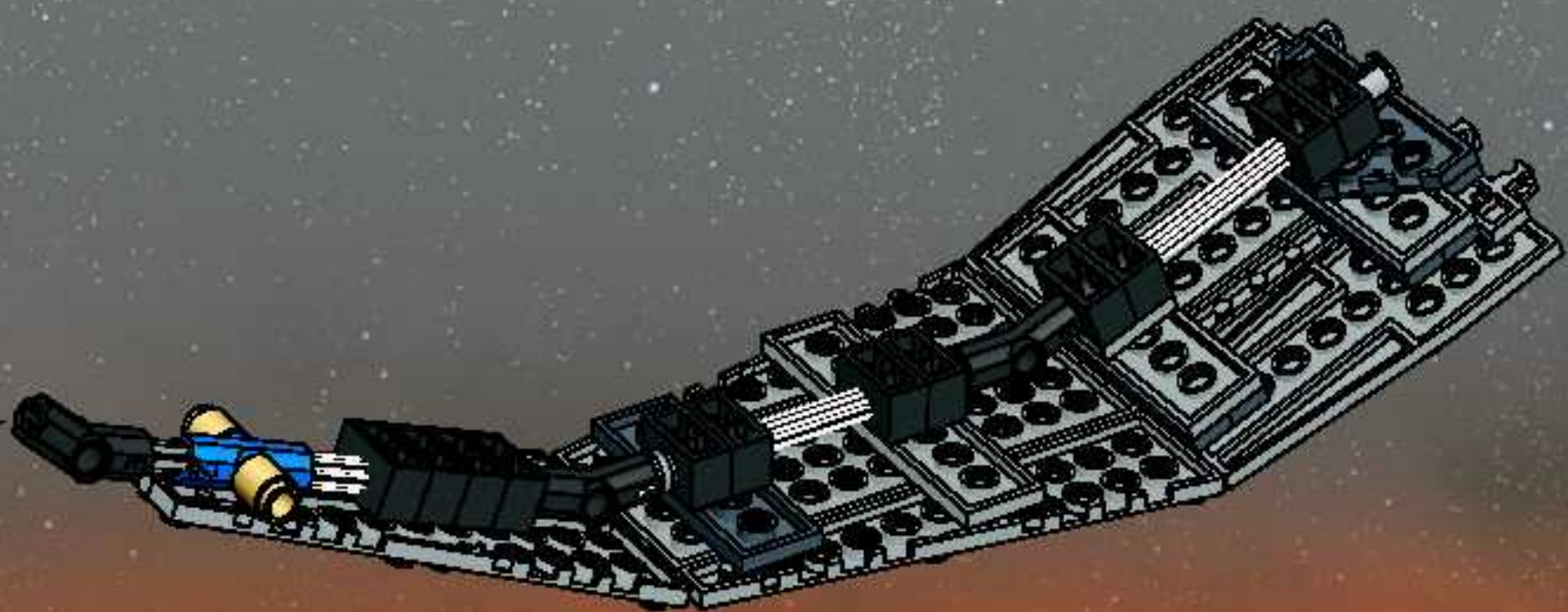
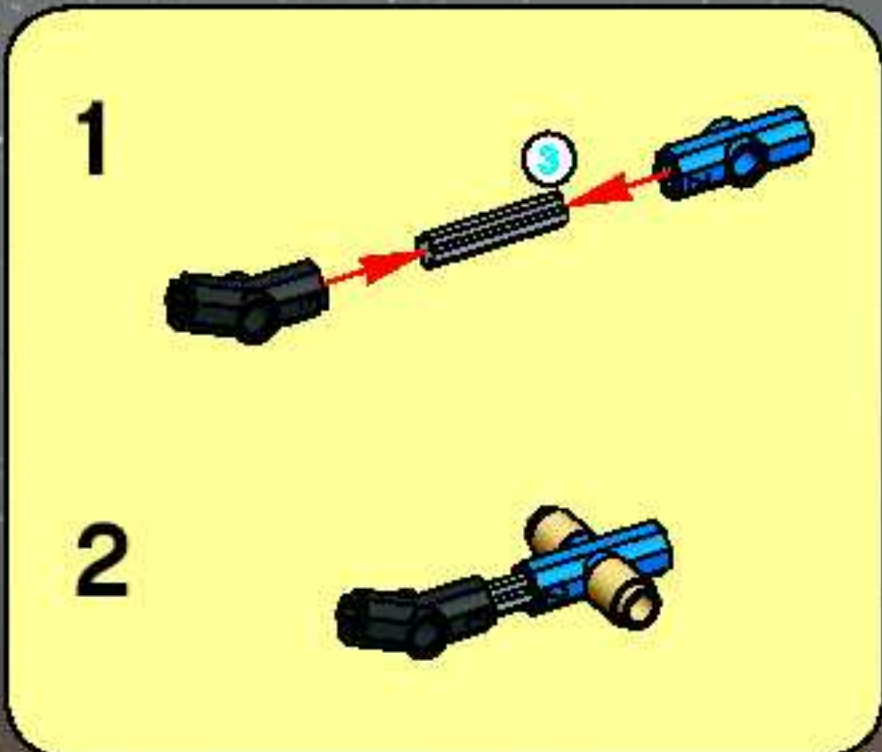

3x



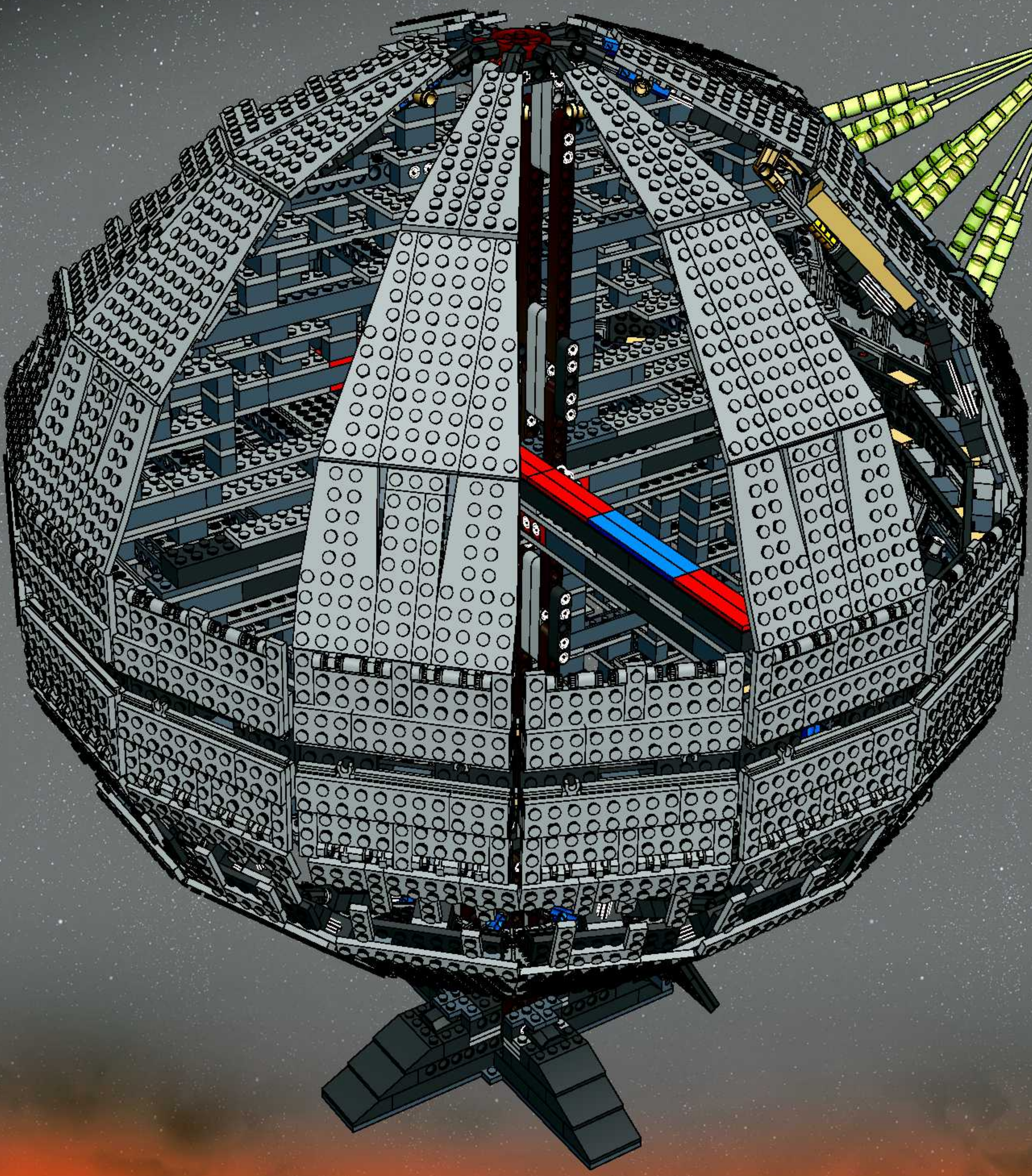





1

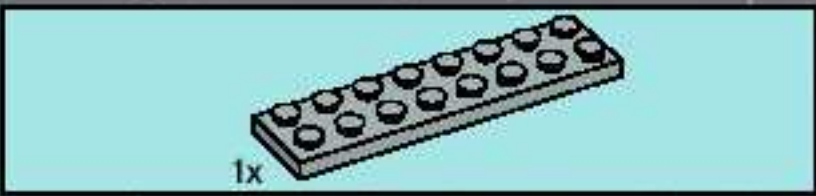

2

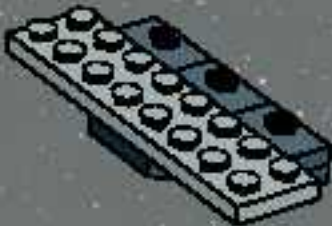

3

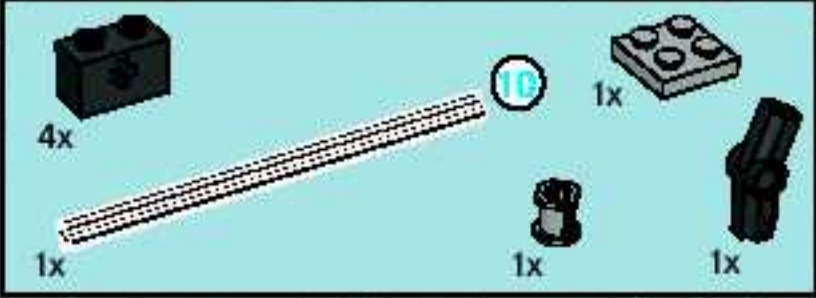
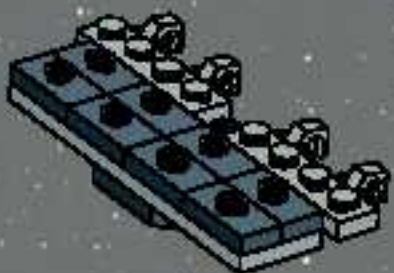

4

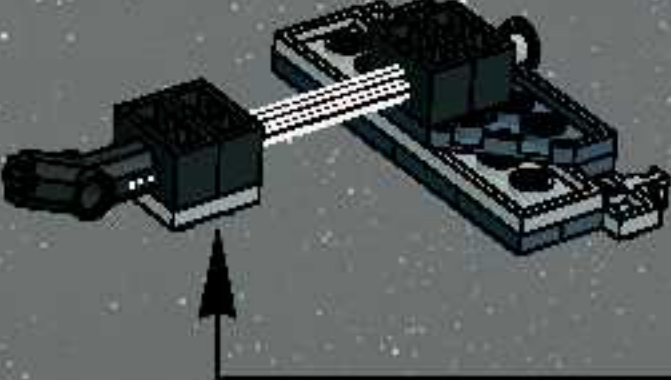

1

2

3

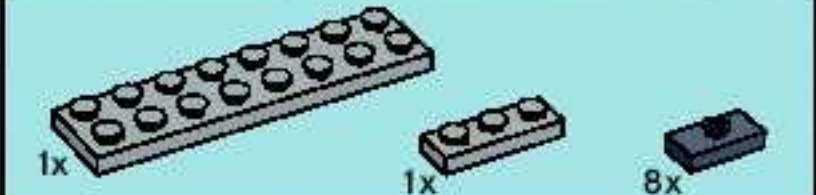

5

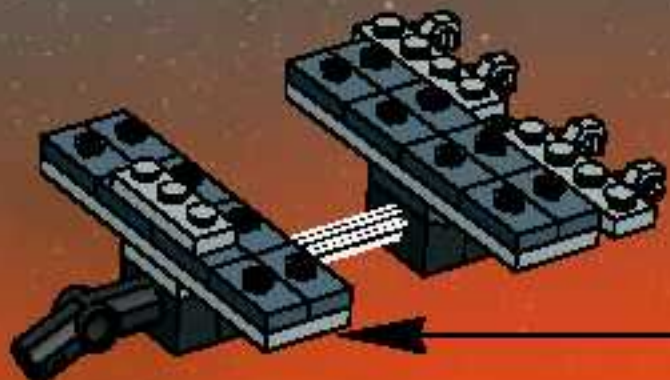

1

2



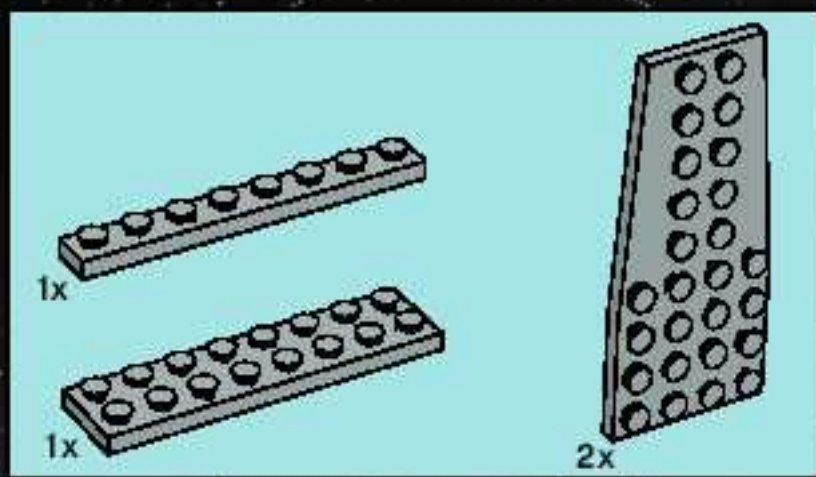

6

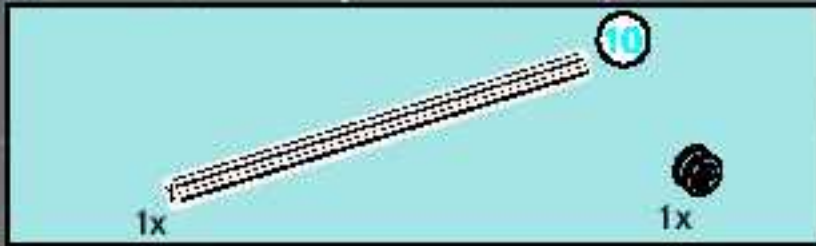
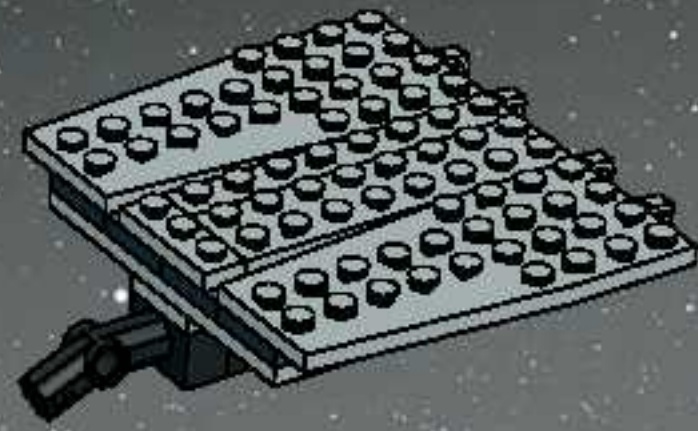

7

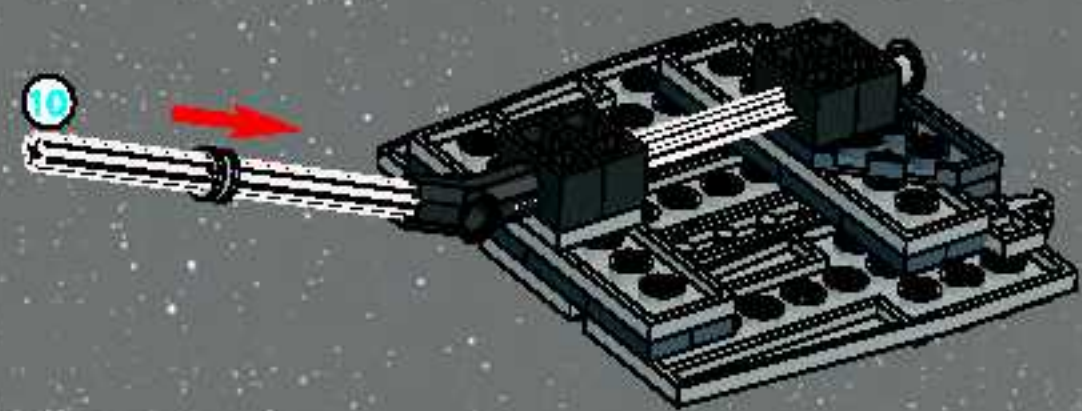

8



9

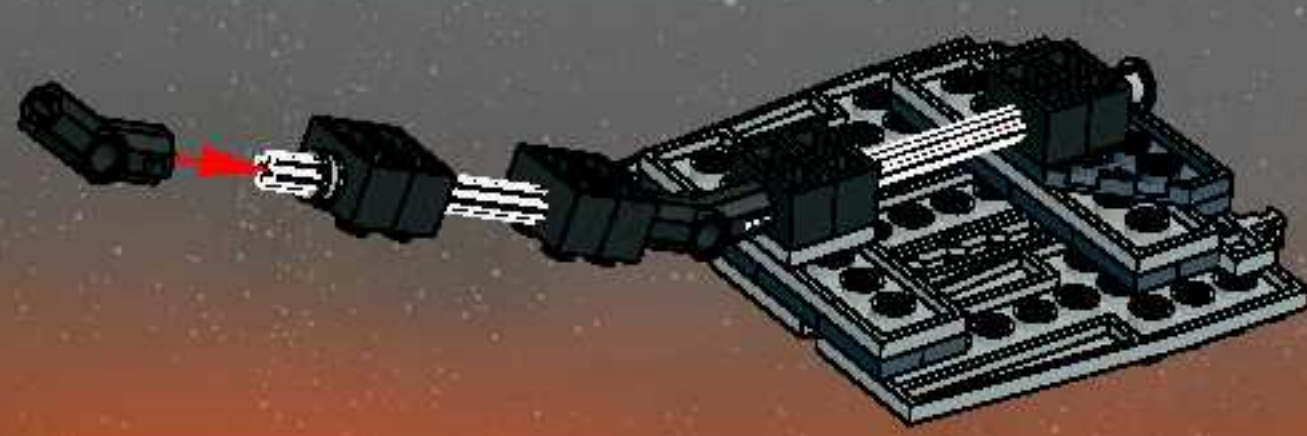



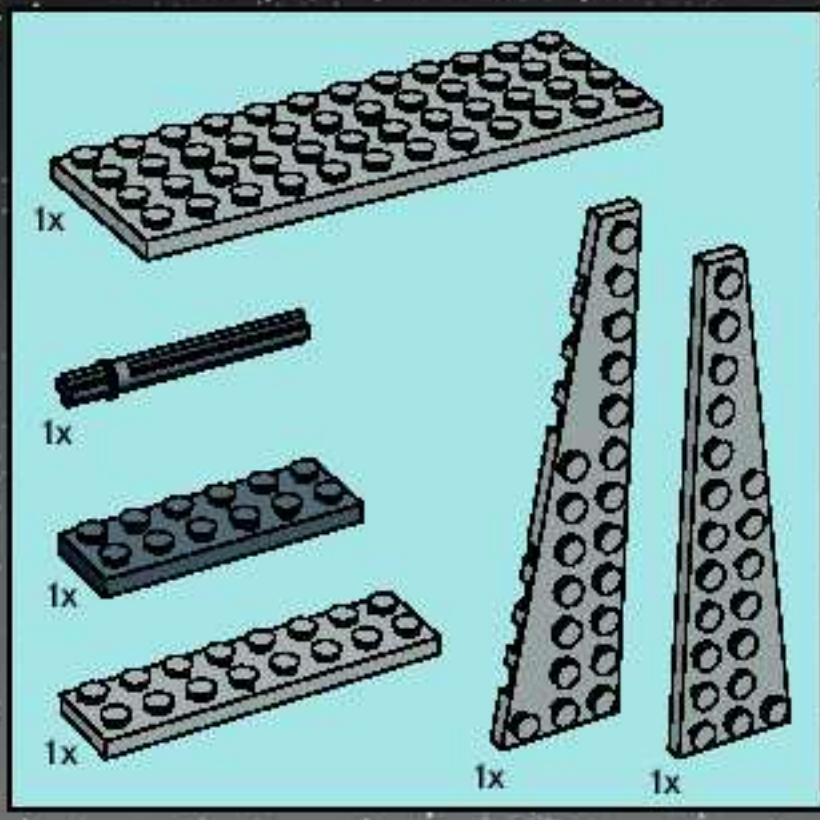

10

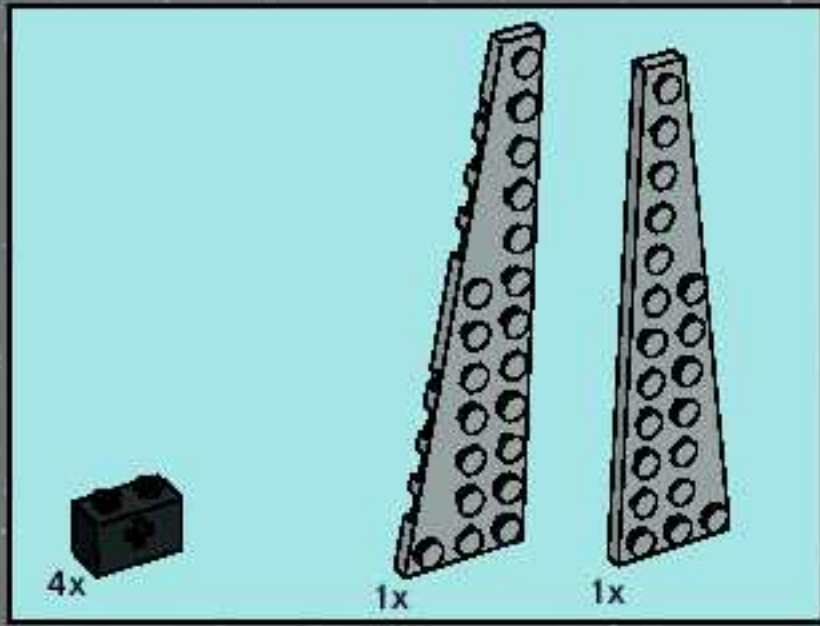
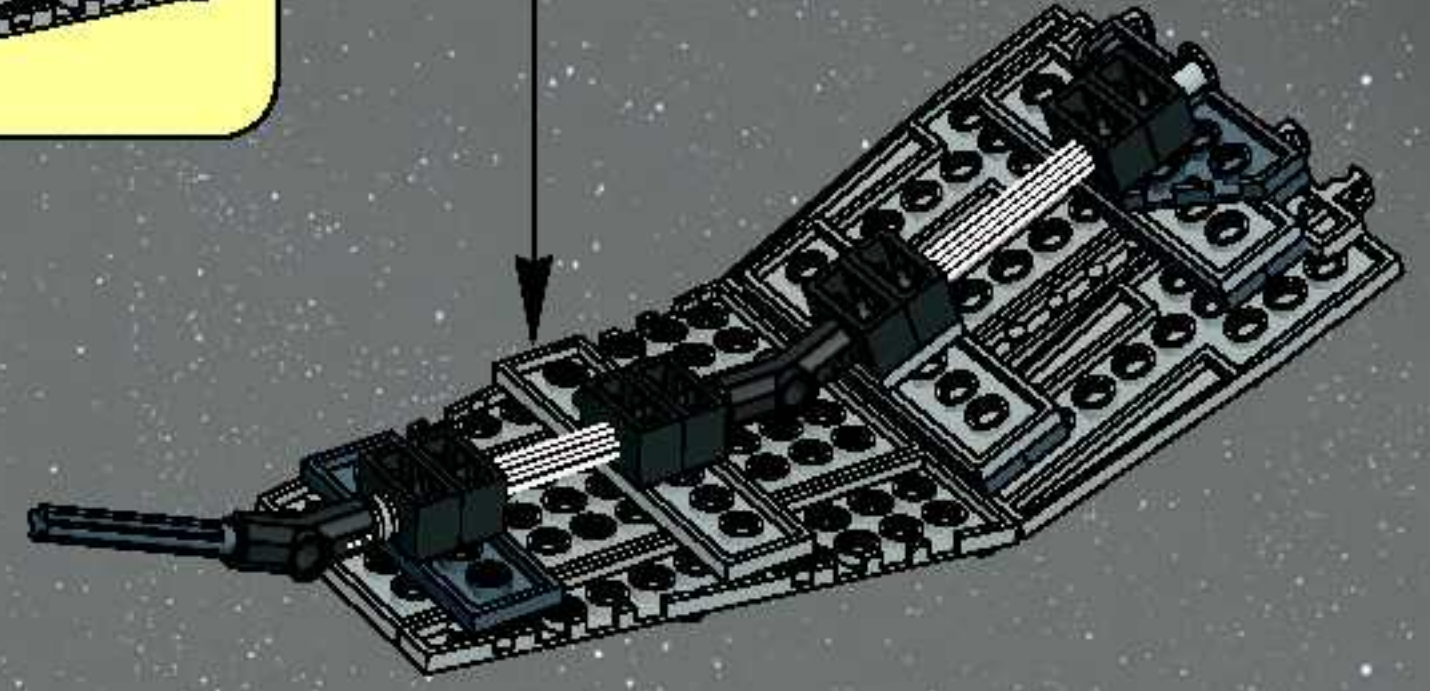
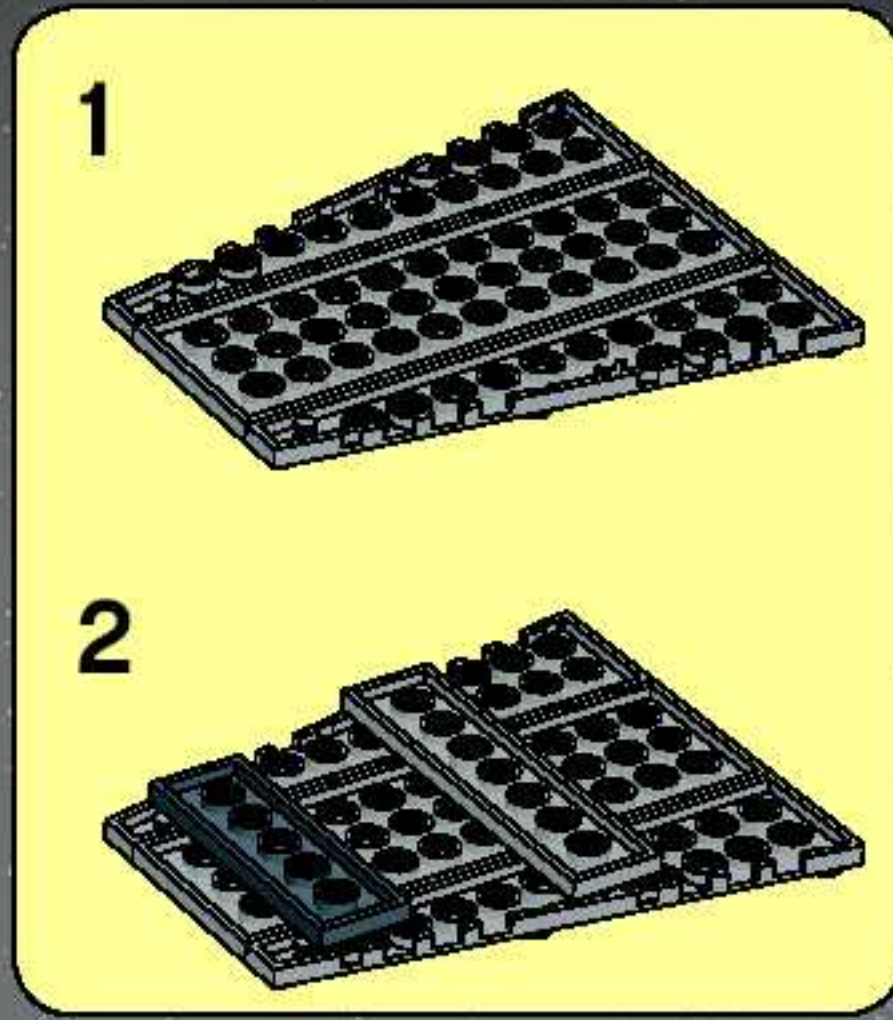

11

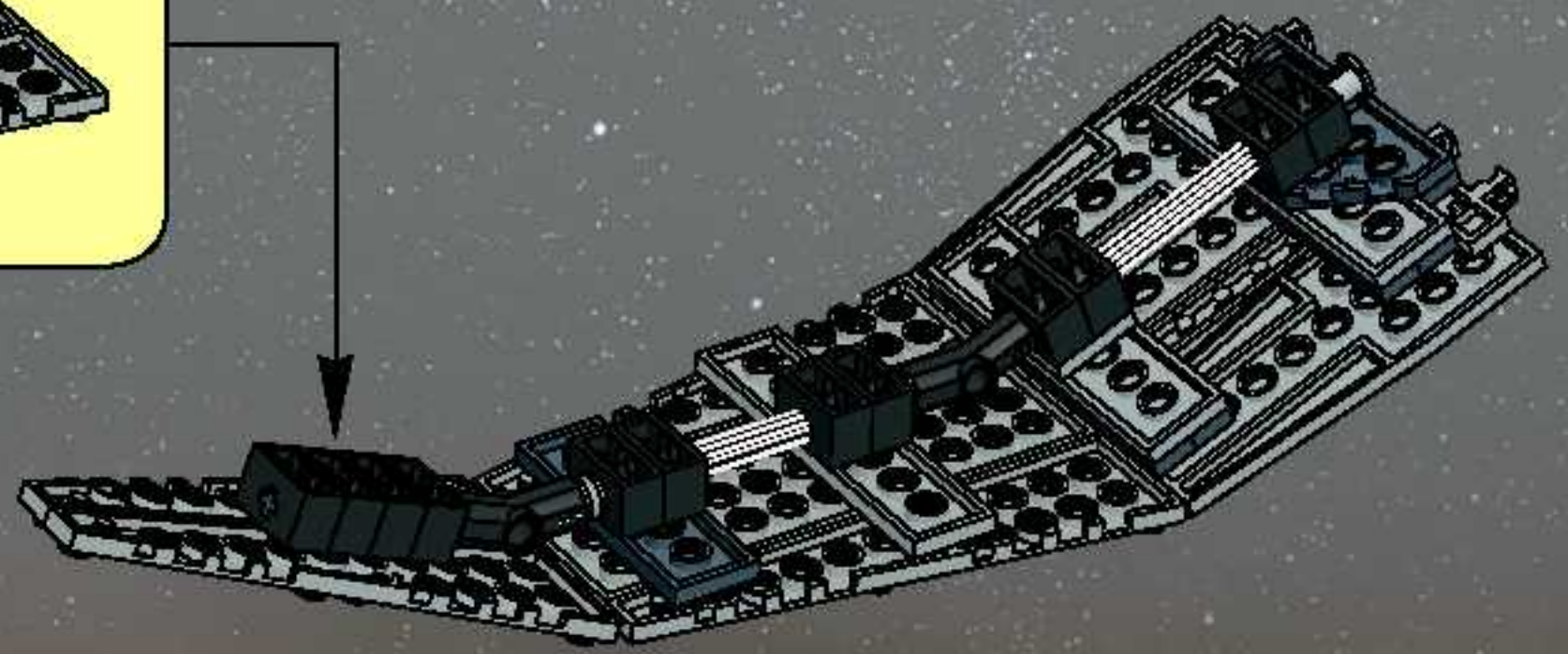
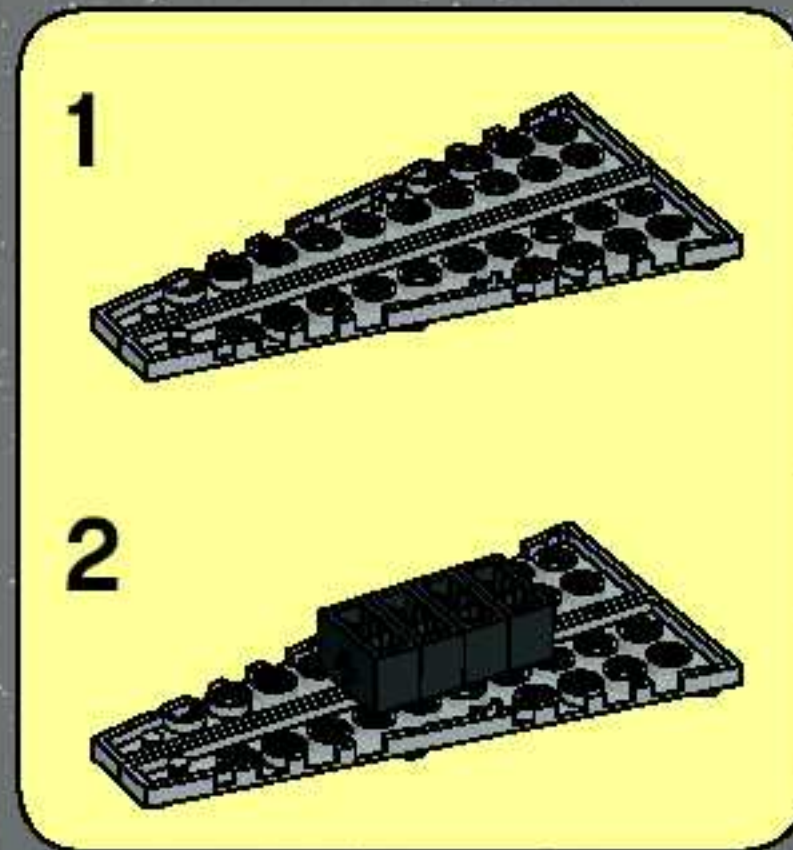

3x



