

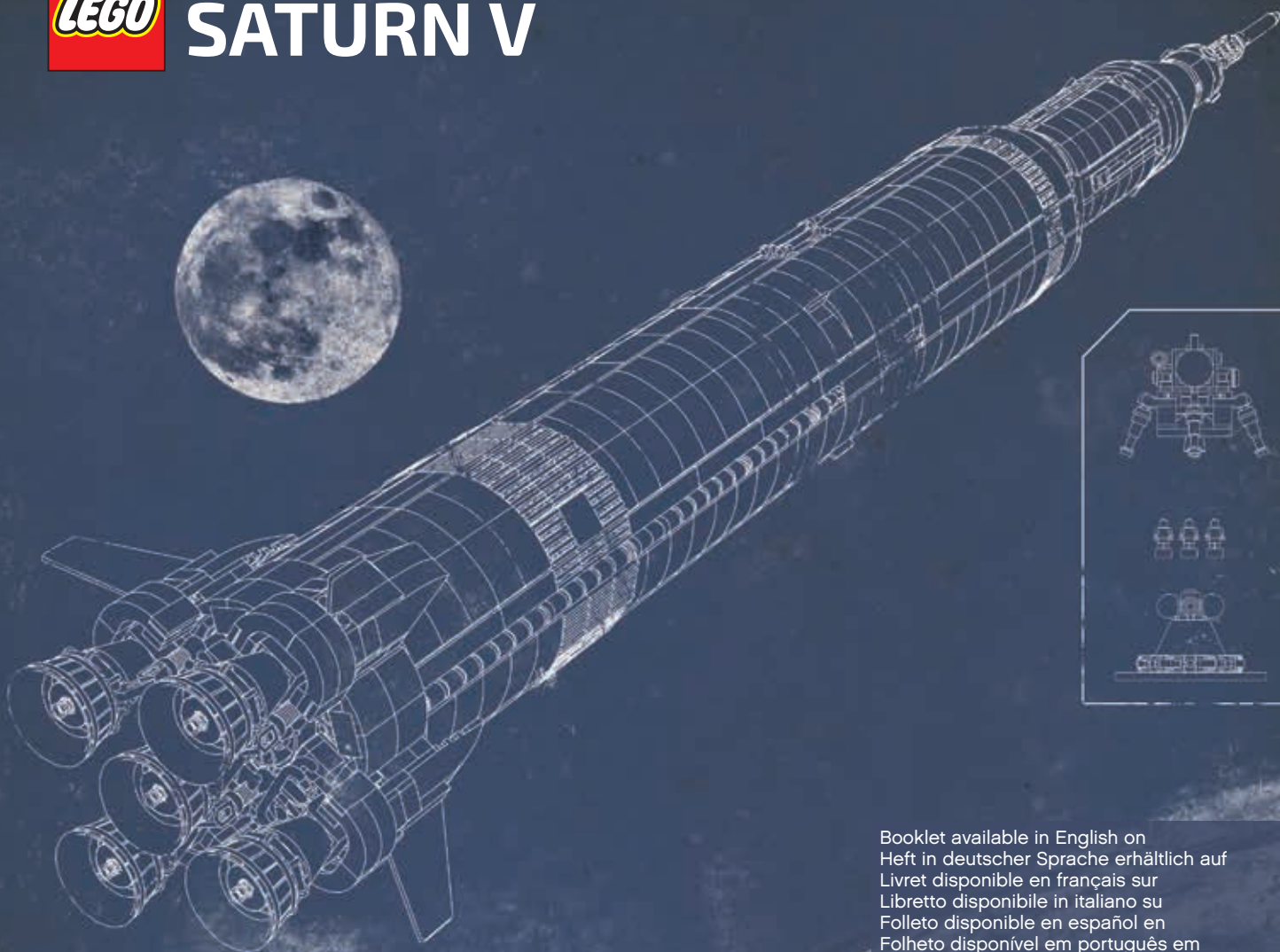

NASA APOLLO
SATURN V



Booklet available in English on
Heft in deutscher Sprache erhältlich auf
Livret disponible en français sur
Libretto disponibile in italiano su
Folleto disponible en español en
Folheto disponível em português em
A füzet magyarul ezen a honlapon olvasható
如需中文版手册, 请访问 LEGO.com/ideas

SATURN V BUILDING INSTRUCTIONS

- 21309 -



The Apollo Program

On May 25, 1961, President John F. Kennedy challenged his country to safely send and return an American to the Moon before the end of the decade. NASA met that challenge with the Apollo program. It would be the first time human beings left Earth orbit and visited another world. The Apollo program played a crucial role in space exploration and made it possible to explore more distant worlds further in the future.

The Apollo program consisted of 11 spaceflights. The first two missions, Apollo 7 and 9, were Earth-orbiting missions used to test the Command and Lunar Modules. The next two, Apollo 8 and 10, tested various components while orbiting the Moon, also taking photographs of the lunar surface. While Apollo 13 did not land on the moon due to a malfunction, a total of six other missions did and returned with a wealth of scientific data and almost 881.8 lbs (400 kilos) of lunar samples.

The first manned mission to the moon was Apollo 8. It circled around the moon on Christmas Eve in 1968. Just over six months later on July 20, 1969, the world witnessed one of the most astounding technological achievements of the 20th century when a NASA astronaut on Apollo 11 became the first human to set foot on the Moon.

The Apollo 11 mission lasted 195 hours, 18 minutes and 35 seconds - about 36 minutes longer than planned. After lunar orbit insertion, the Command Module (CM) and Lunar Module (LM) separated. While one crewmember remained in the CM, which orbited the Moon, the other two astronauts made the historic journey to the lunar surface in the LM. After exploring the surface and setting up experiments for 21 hours and 36 minutes, the astronauts returned safely to the CM and began the journey back to Earth.

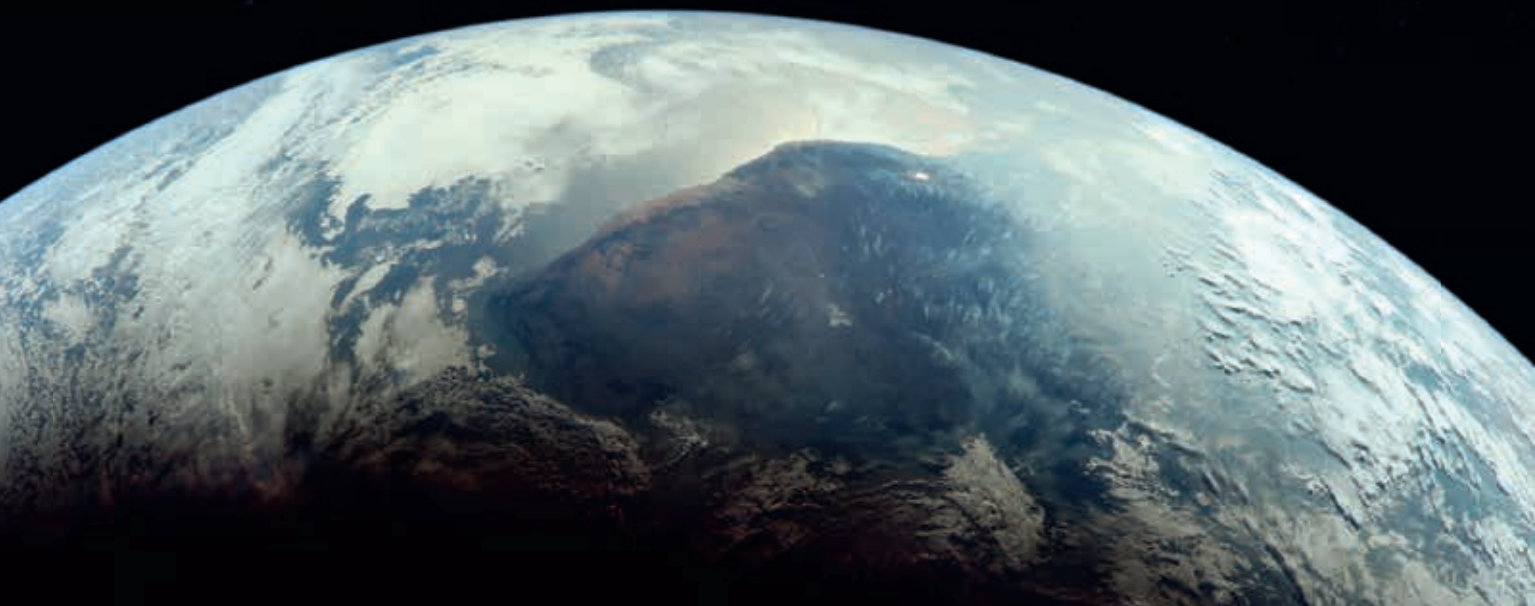

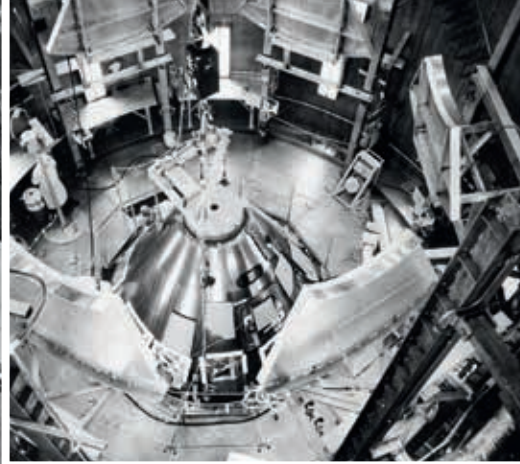

The Saturn V moves at one mile per hour
down the crawlerway toward pad 39A >>

Workers prepare the S-IC first stage
in the transfer aisle of the Vehicle
Assembly Building >

Photographers film the Apollo 11 rollout >

Pre-flight training <

Kennedy Space Center technicians >>
inspect the LRV.

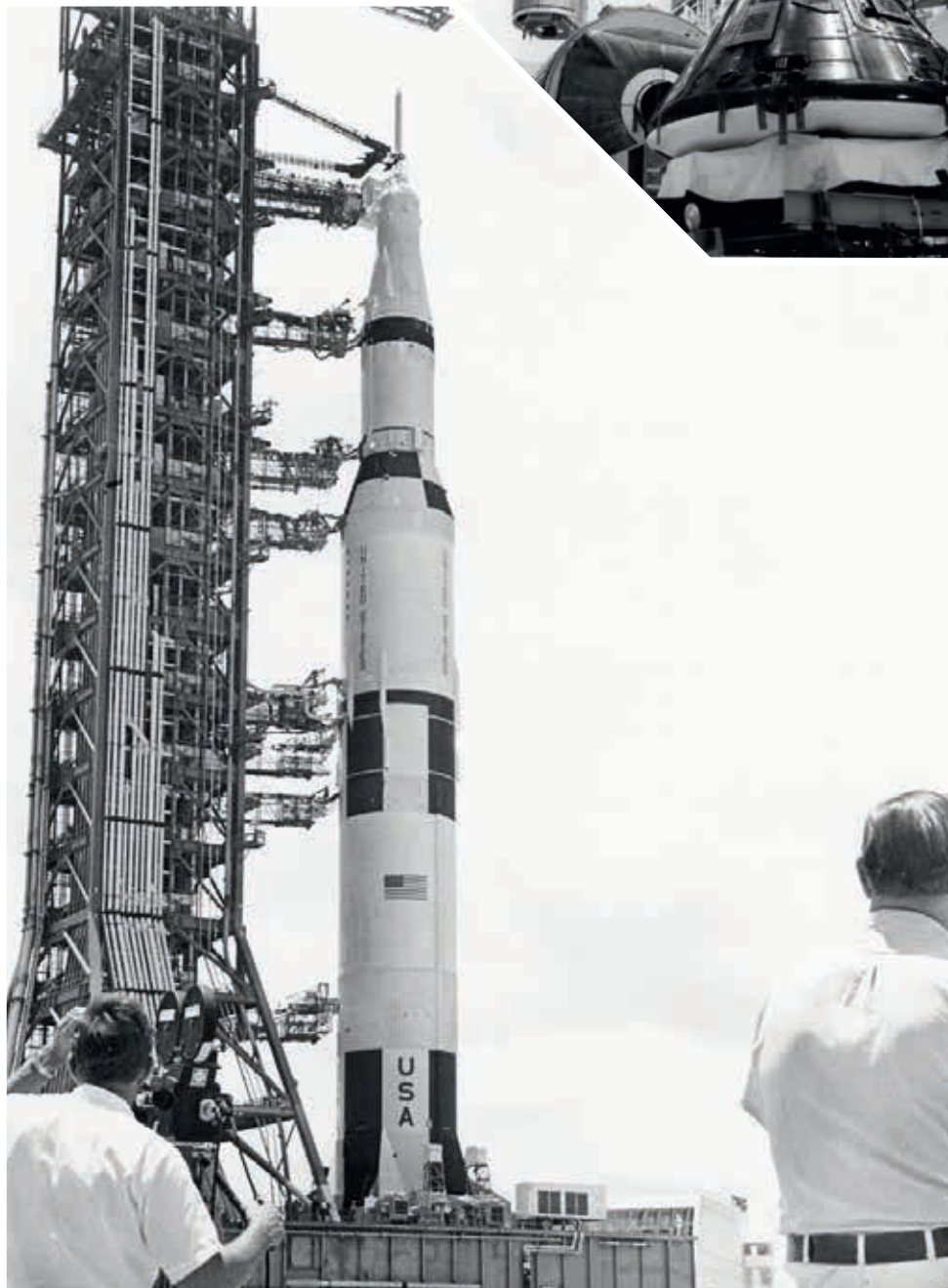

Saturn V

Saturn V was the most powerful rocket that had ever flown successfully and was used in the Apollo program in the 1960s and 1970s. The rocket was 363 ft. (111 m) tall and weighed 6.2 million lbs (2.8 million kilos) when fully fueled for liftoff. The Saturn V used for the later Apollo missions had three stages. Each stage would burn its engines until it was out of fuel and would then separate from the rocket. The engines on the next stage would fire, and the rocket would continue into space. The first stage had the most powerful engines, since it had the challenging task of lifting the fully fueled rocket off the ground. The first stage lifted the rocket to an altitude of about 42 miles (68 km). The second stage carried it from there almost into orbit. The third stage placed the Apollo spacecraft into Earth orbit and pushed it toward the moon.



The S-II second stage is moved into position for mating with the S-IC first stage



Mating of the Apollo 11 spacecraft to the Saturn V launch vehicle

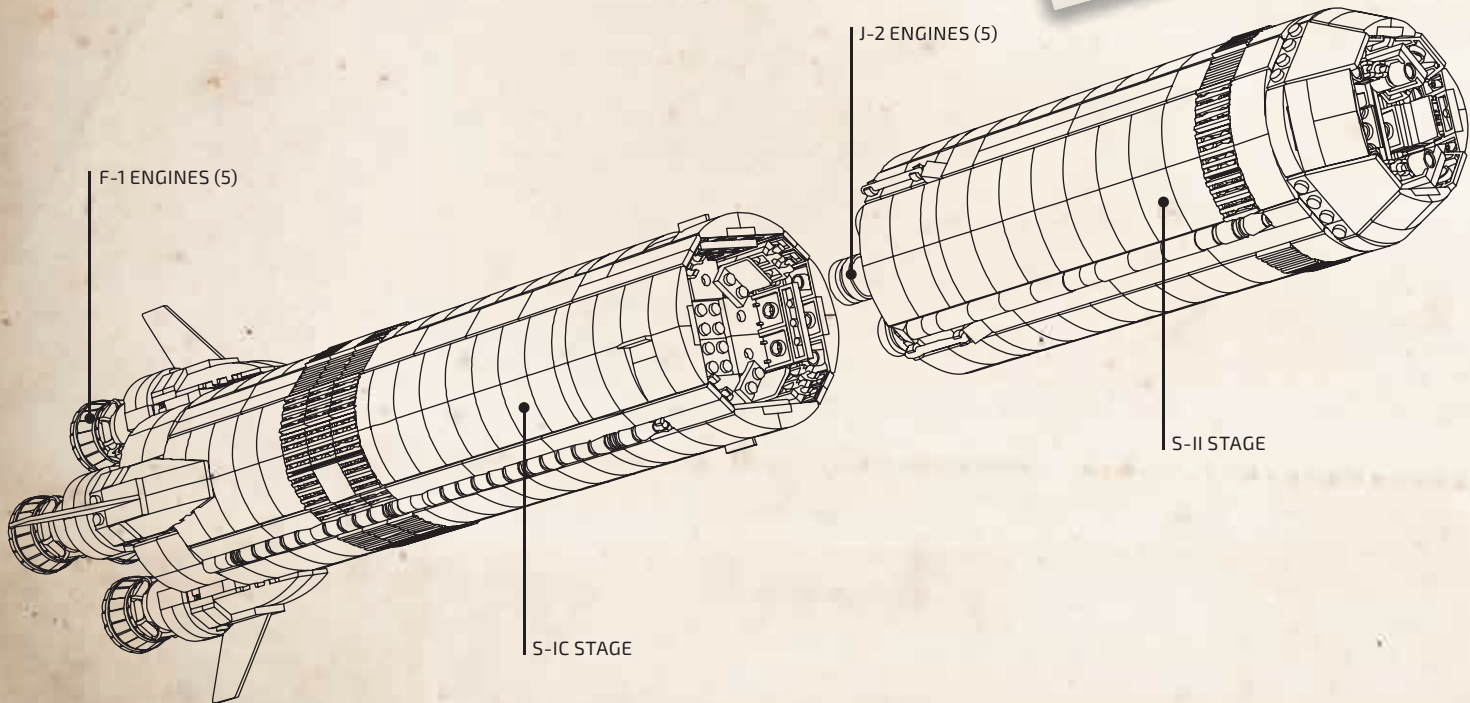

The Apollo 11 CSM being moved from work stand for mating

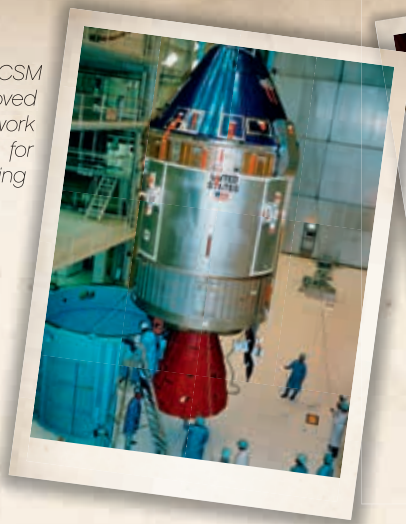

Lunar Module 5 ascent stage in Final Assembly area on overhead hoist

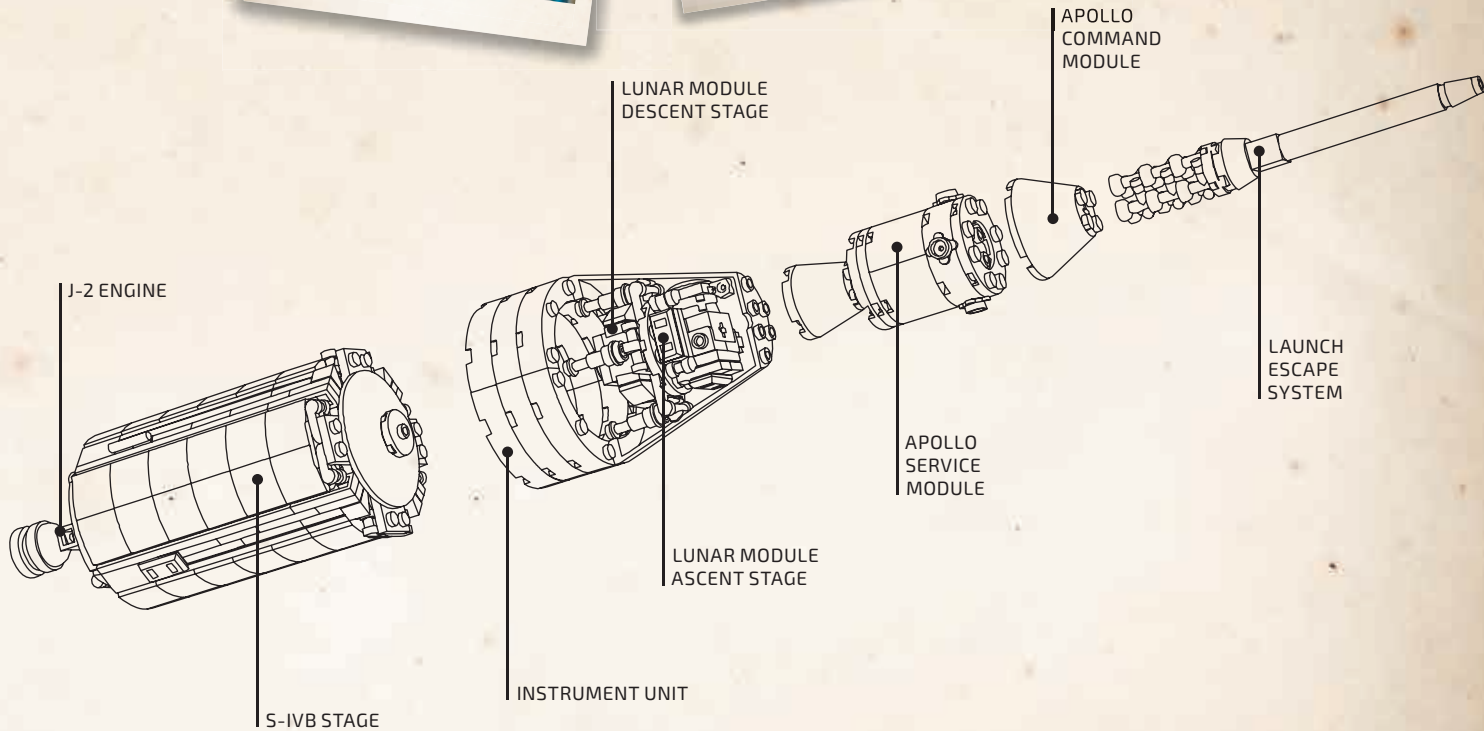

Transposition, docking, and extraction

Shortly after the trans-lunar injection maneuver that placed the Apollo spacecraft on its trajectory towards the Moon, the transposition and docking maneuver would be performed. This involved an astronaut separating the Apollo Command/Service Module (CSM) spacecraft from the adapter which fastened it to its launch vehicle upper stage, turning it around, and docking its nose to the Apollo Lunar Module (LM), then pulling the combined spacecraft away from the upper stage.



The Command/Service Module (CSM) separates from the adapter.



The CSM then turns around in preparation for docking with the Lunar Module (LM)



After docking, the CSM pulls the LM away from the launch vehicle's upper stage

Journey to the Moon

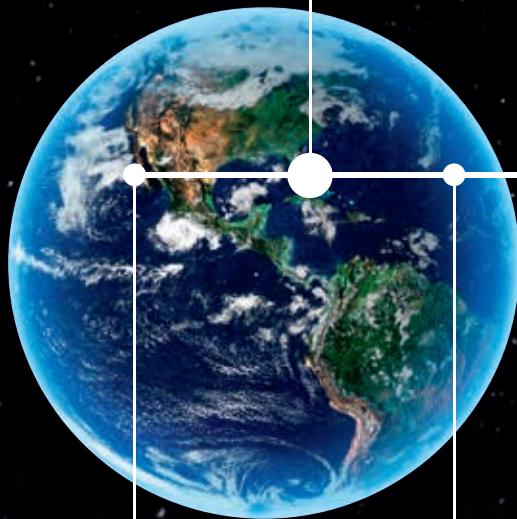
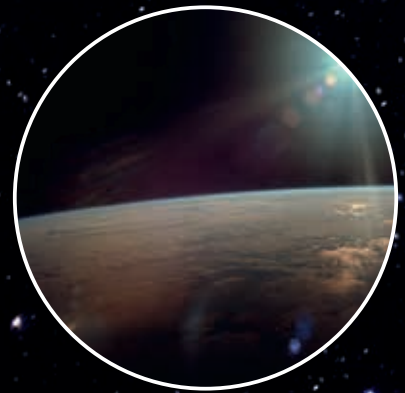

LIFTOFF

LAUNCH ESCAPE
TOWER JETTISON.

S-IVB 2ND ENGINE
IGNITION

CSM DOCKING WITH
LM/S-IVB.

S-IVB ENGINE CUTOFF.

CSM SEPARATION
FROM LM ADAPTER.

TRANSLUNAR
INJECTION "GO"
DECISION.

CSM 180°
TURNAROUND.

S-II/S-IVB
SEPARATION.
S-IV ENGINE IGNITION.

S-IVB ENGINE CUTOFF.

APOLLO SATURN V
ROLLS OUT OF THE
MASSIVE VEHICLE
ASSEMBLY BUILDING

THE FIRST STAGE
FALLS AWAY AS THE
S-II STAGE IGNITES



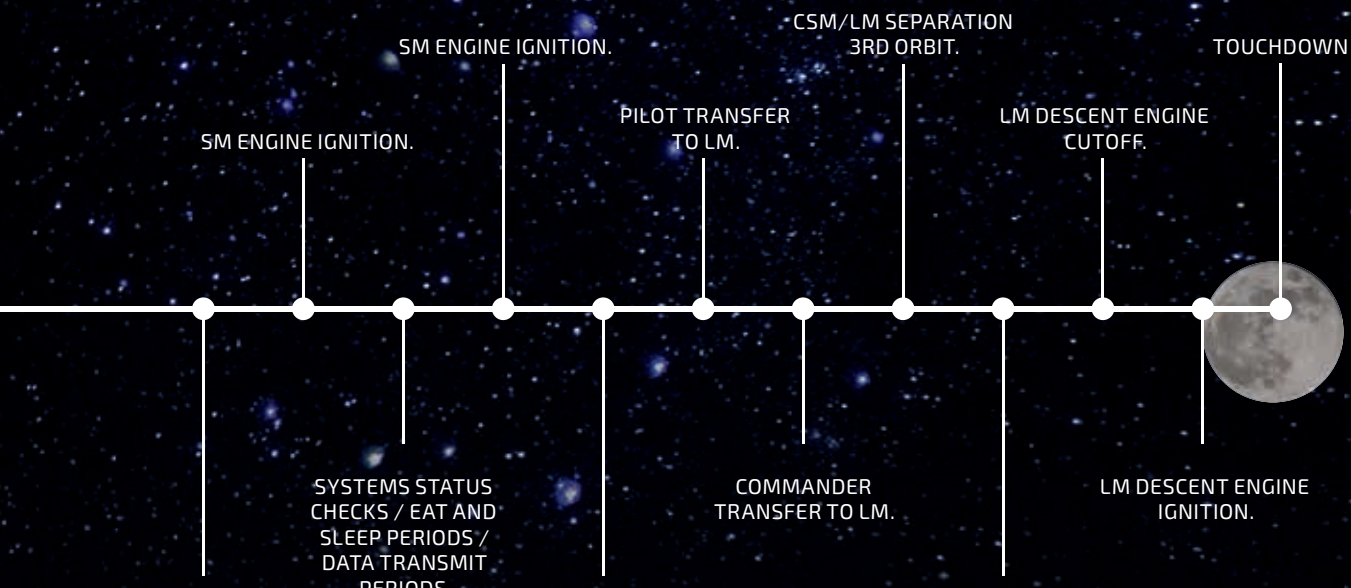

CSM SEPARATION FROM S-IVB.

BEGIN NAVIGATION SIGHTINGS.

LM DESCENT ENGINE IGNITION.

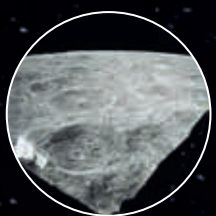

Fan designers

With a shared passion for both space exploration and LEGO® building, Valérie Roche (aka Whatsuptoday) and Felix Stiessen (aka Saabfan) worked closely together to create their impressive Apollo 11 Mission model for LEGO Ideas.

"The most challenging part was the Lunar Landing module. I (Felix) tried building it as small as possible (I wanted it to fit in the half-cone parts as seen in the model) while still looking good and accurate. After that, we began building the rocket around it. We also tried to make the rocket as sound as possible, so Valérie included pillars and beams inside for structural integrity."

"It actually took quite a long time to finish the whole model. There were often times when one

of us just abandoned the project for a few weeks and came back to it later; however, thanks to the fact that it is a collaborative project, it was always the case that one of us continued making progress on the project and re-motivated the other. All in all, we would say it took us about a year to complete."

"We were surprised (and happy, of course) when we learned our model would be the latest one in the LEGO Ideas series. What we like about the LEGO Ideas platform is the feedback and support you get from the community. It's great to reply to comments, read suggestions and improve your model in the updates. Of course, the chance of designing your own LEGO set is also really cool!"

Felix Stiessen



Valérie Roche

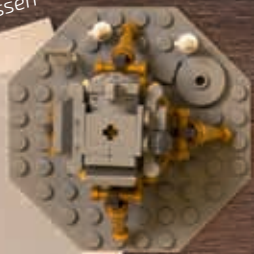



Carl Thomas Merriam (left)
Michael Psiaki (middle)
Austin William Carlson (right)

LEGO® designers

Michael Psiaki, Carl Thomas Merriam and Austin William Carlson are all full-time LEGO® designers and avid space enthusiasts, so this was a project they very much wanted to be a part of. As Michael explains:

"We were actually not asked. I was so excited when I heard that the project was potentially going to happen, and told Carl about it because I knew he was also a space fanatic. We decided it would be really cool to work together since it is such a big model, so we approached the Ideas team about helping to develop the product."

"We were amazed by how big the actual model was and how it was able to separate into all of the different stages and components. This was very difficult to implement in our final design, since we needed to make sure that the rocket was strong enough when connected together, but also easy to separate."



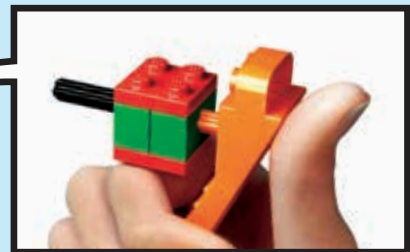

LEGO.com/brickseparator

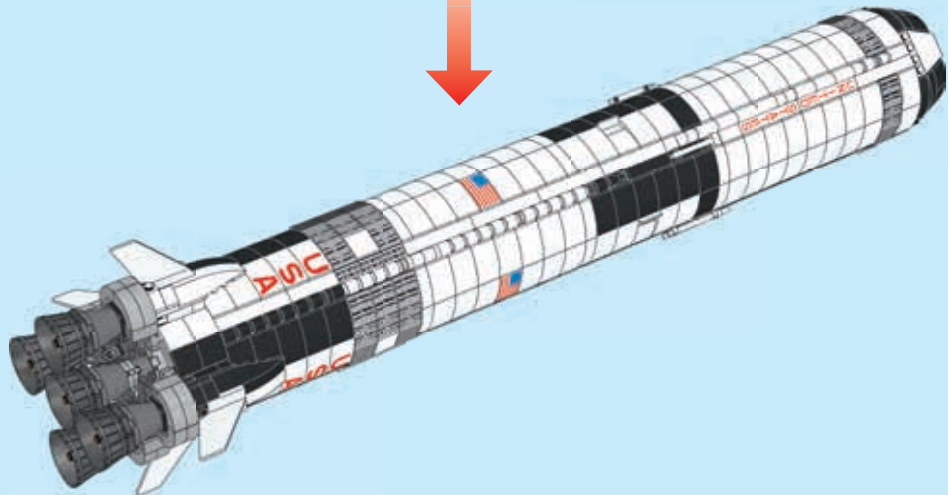
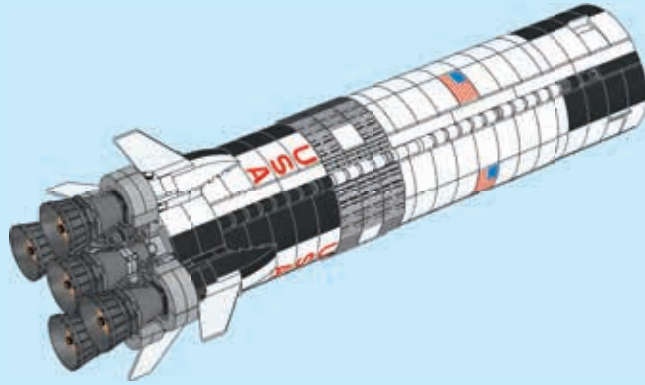

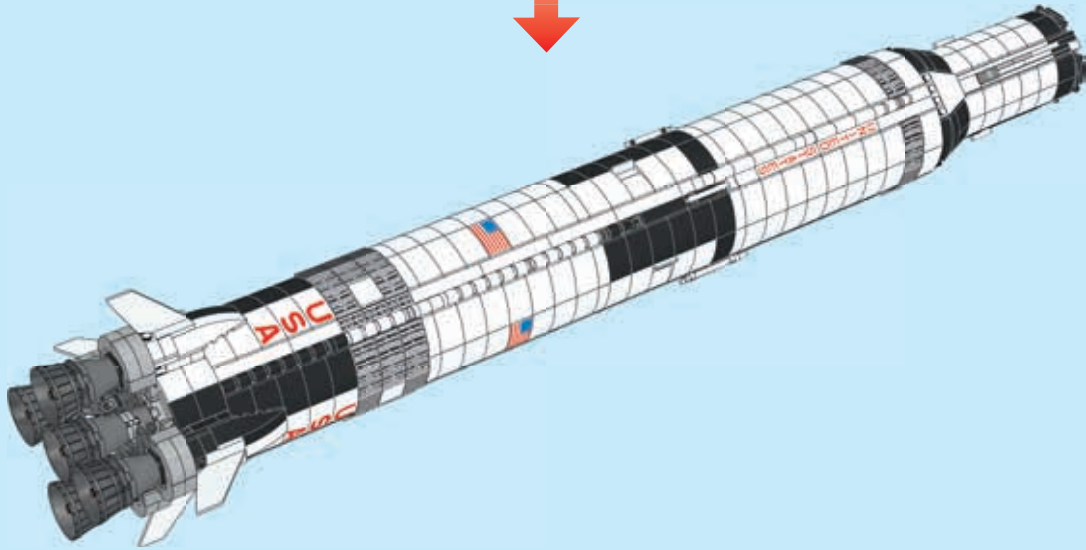

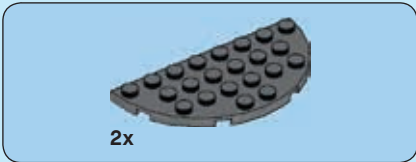
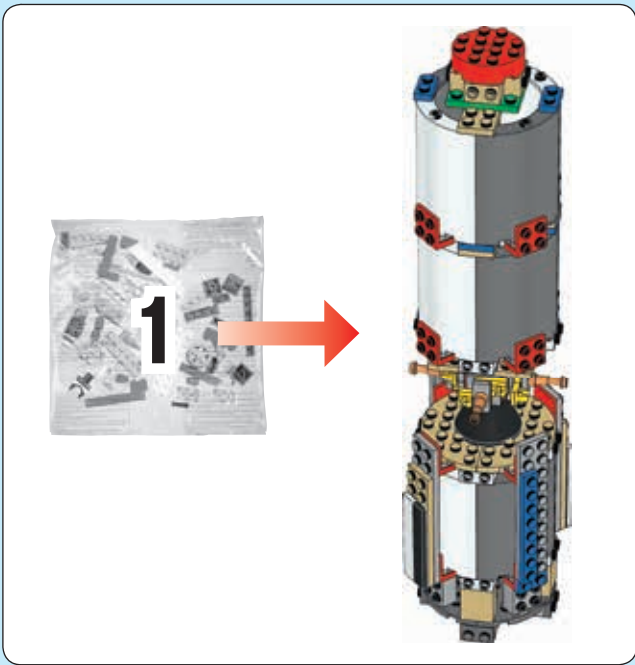

1

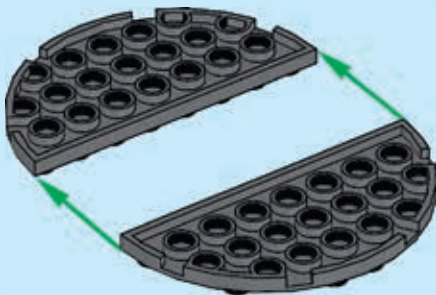

2

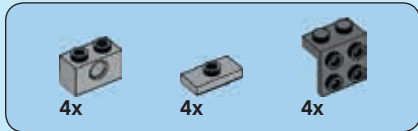
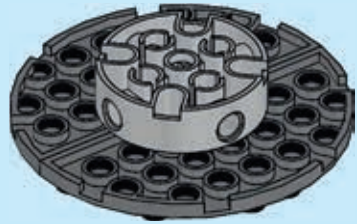

3

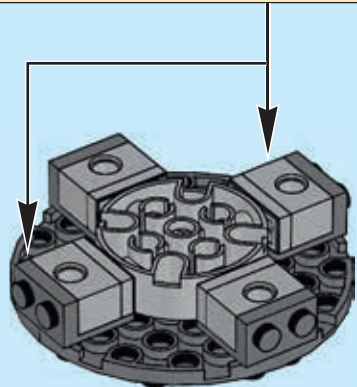
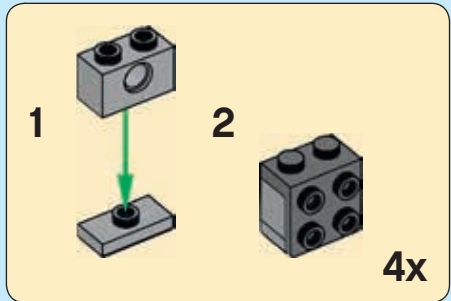

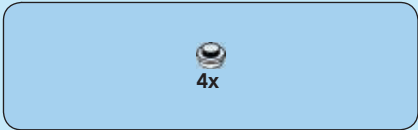

4

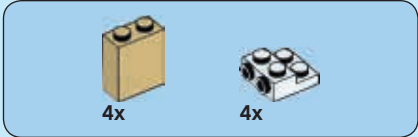
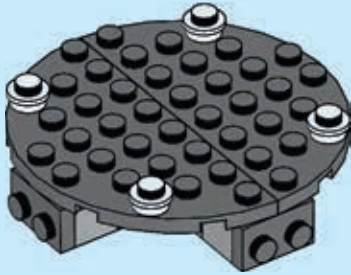
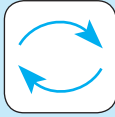

5

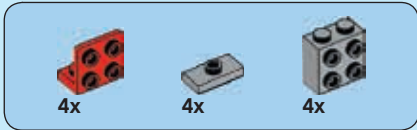
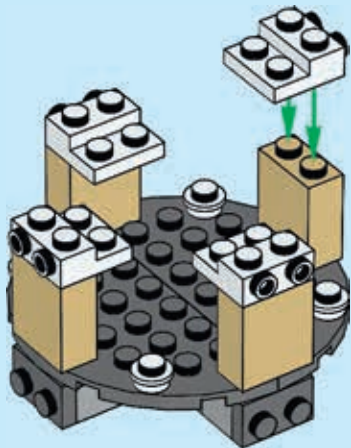

6

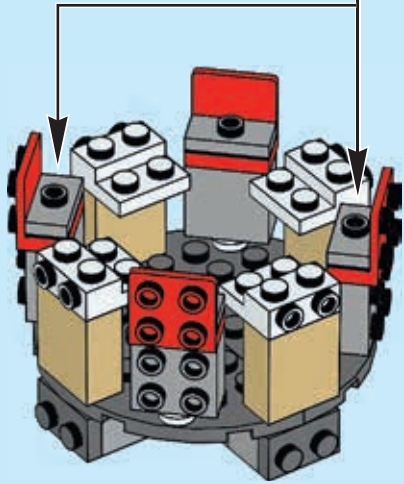
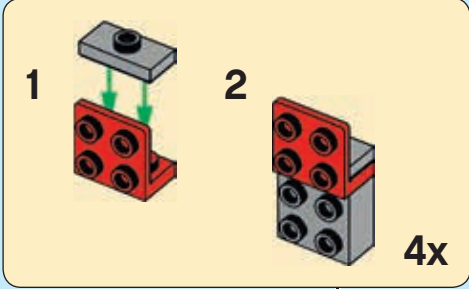

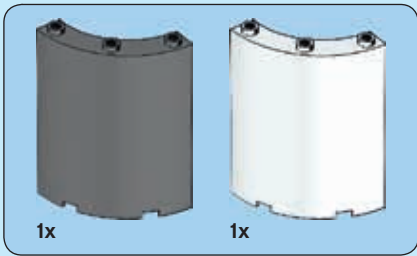

7

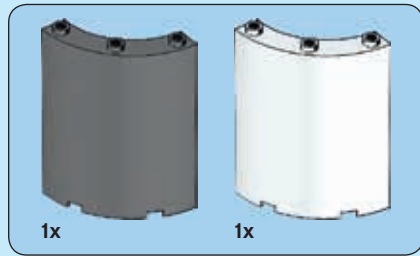
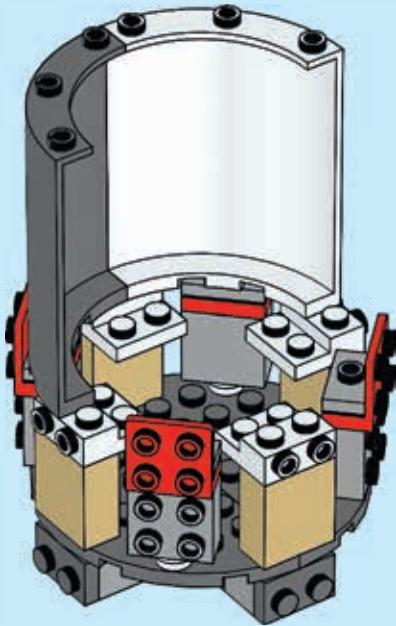

8

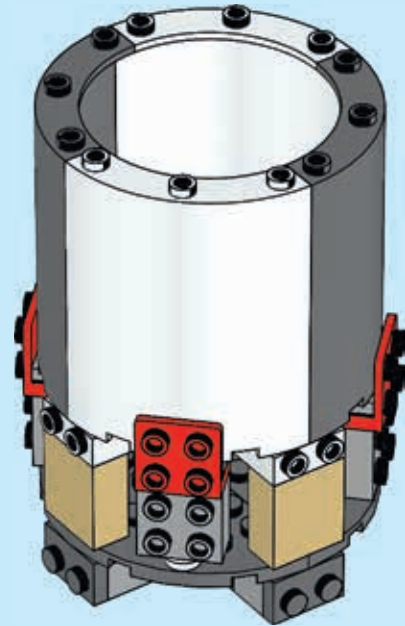



9

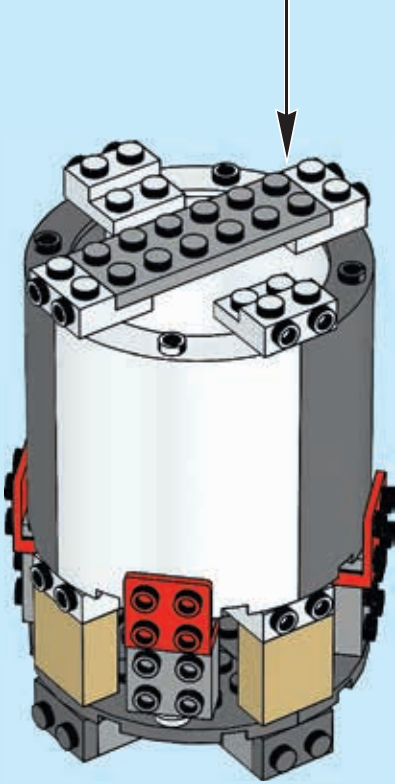
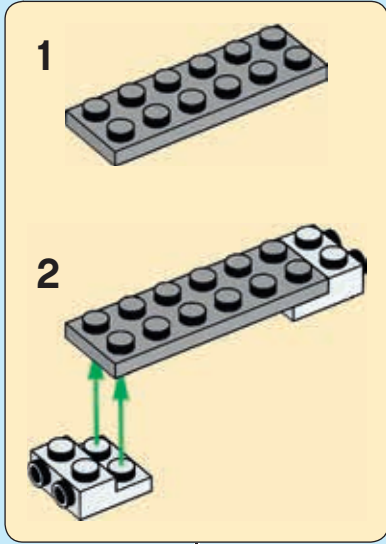

10

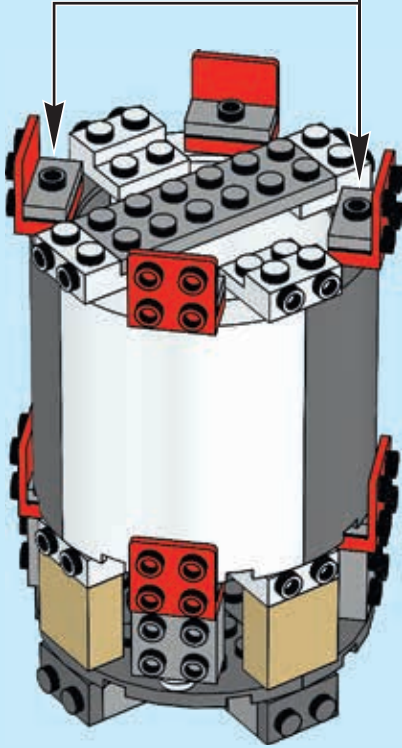
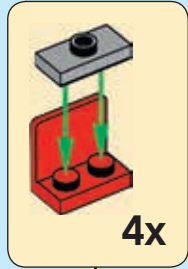

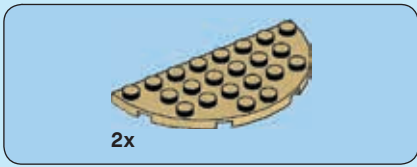

11

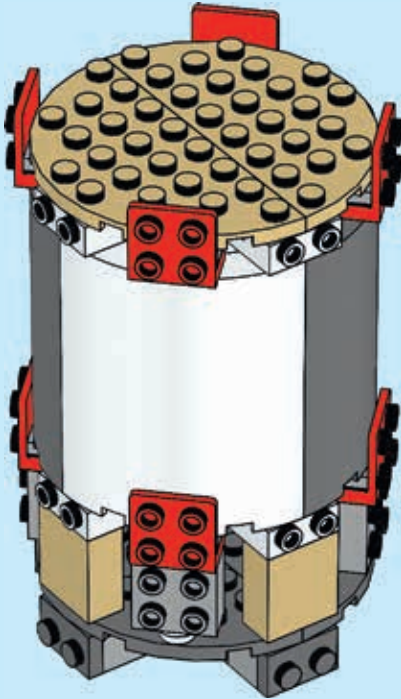

12

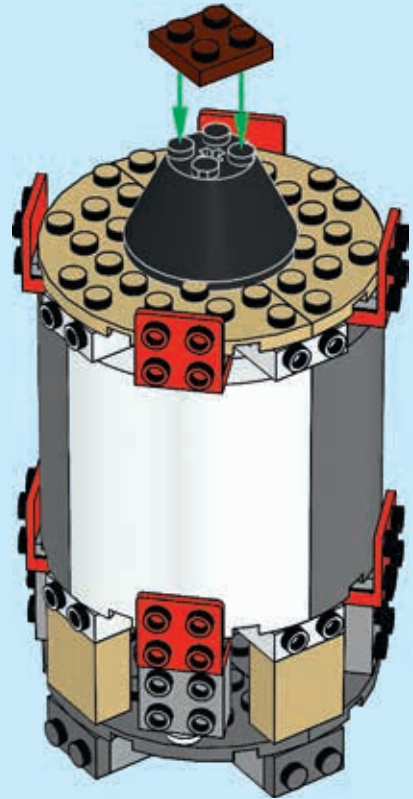



13

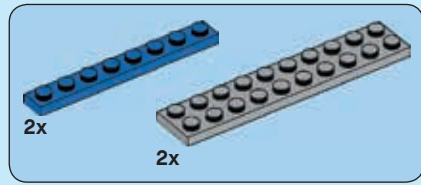
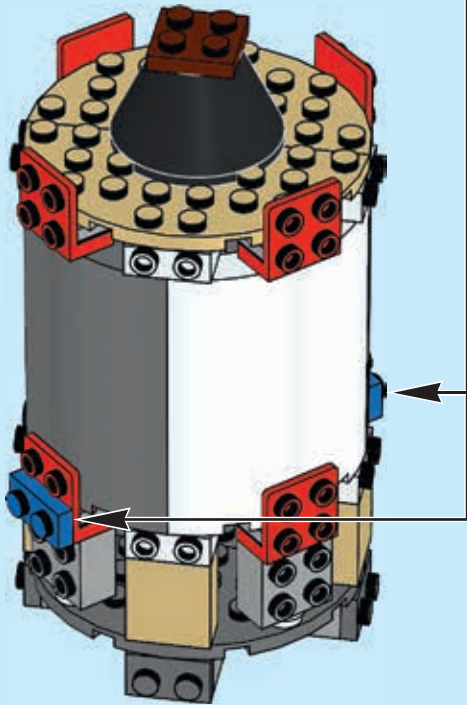

14

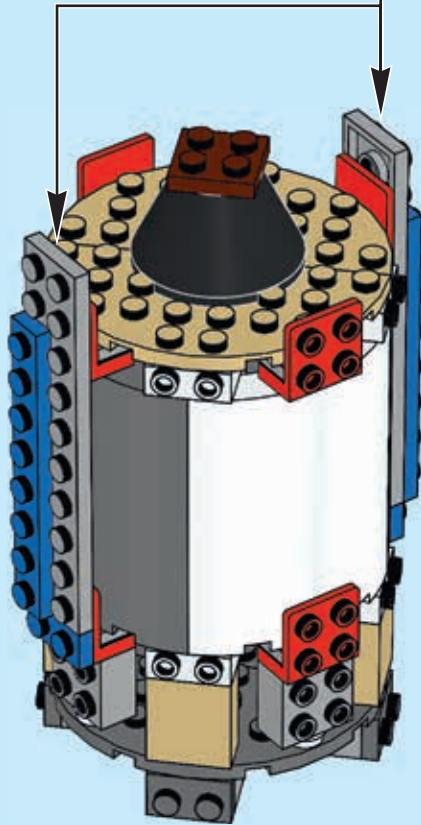
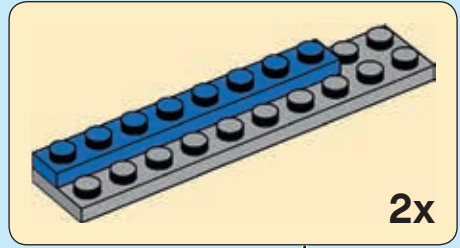

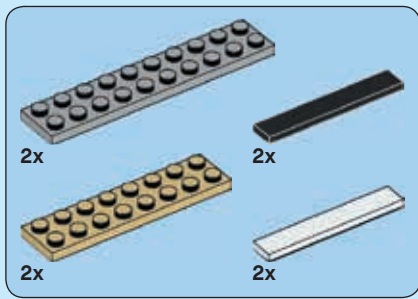

15

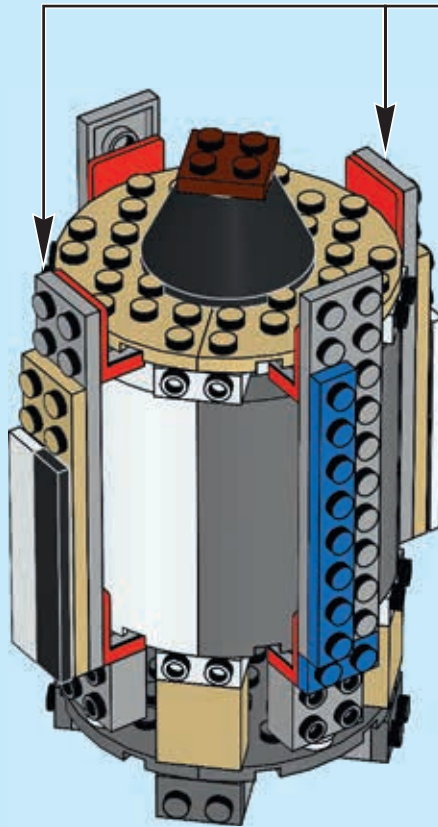
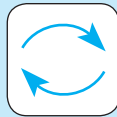
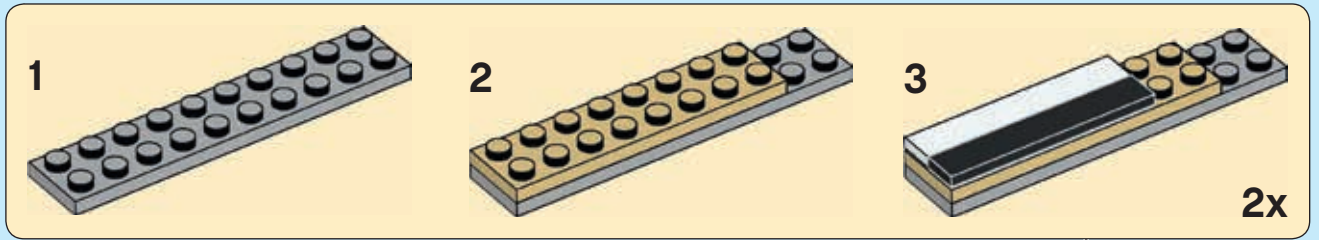



2x

16

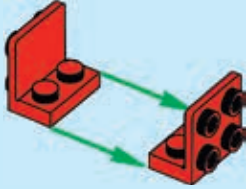

1x

17



2x

18



8x

19

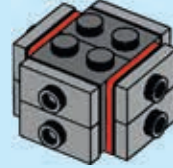

8x

20

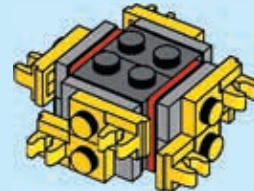

4x

21

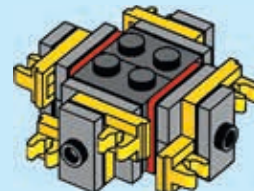

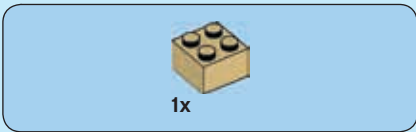

22

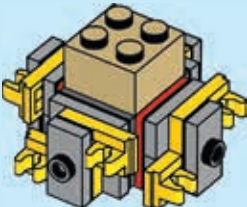

23

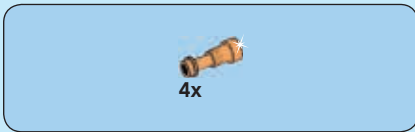
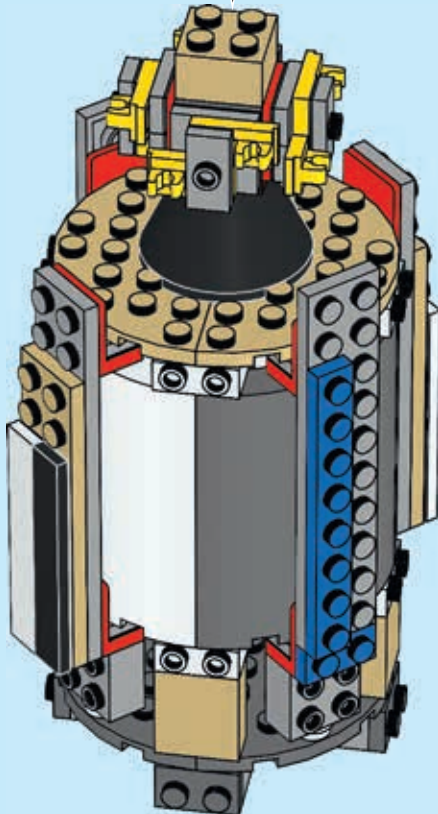

24

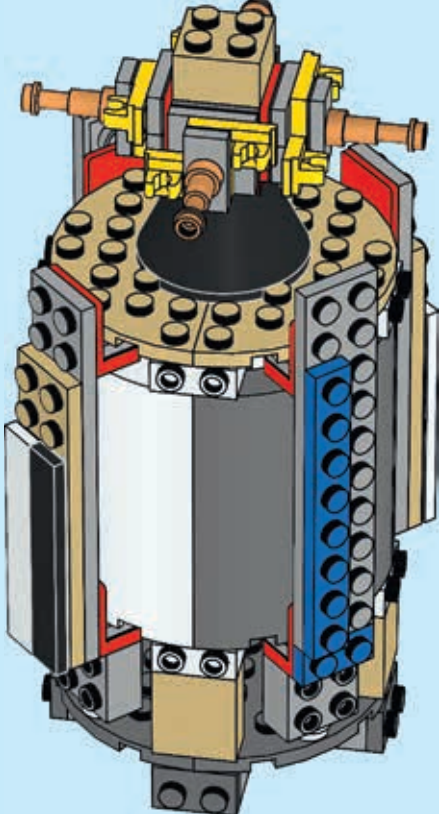

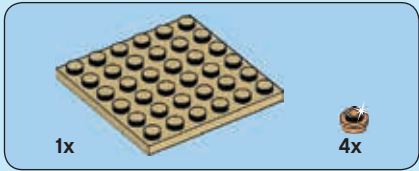

25

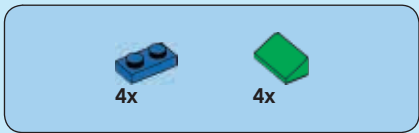
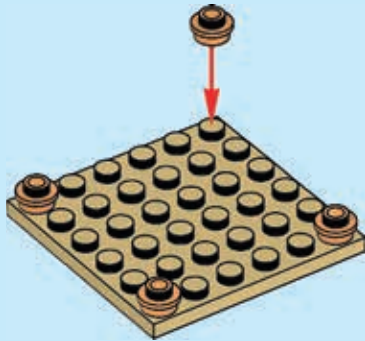

26

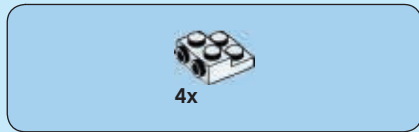

27

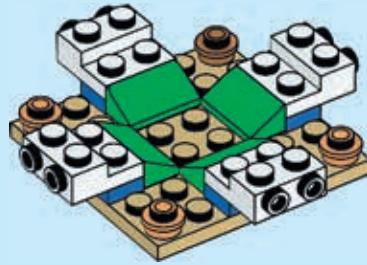

28

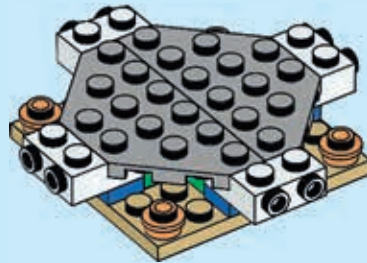

29

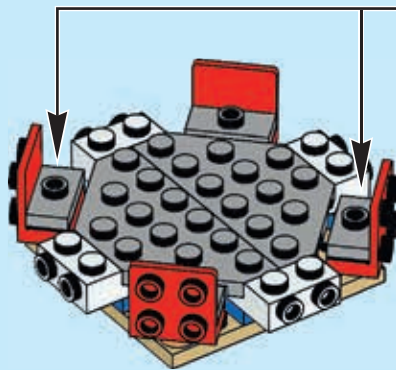
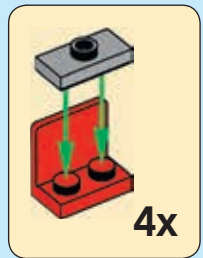



30

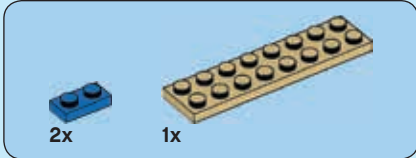
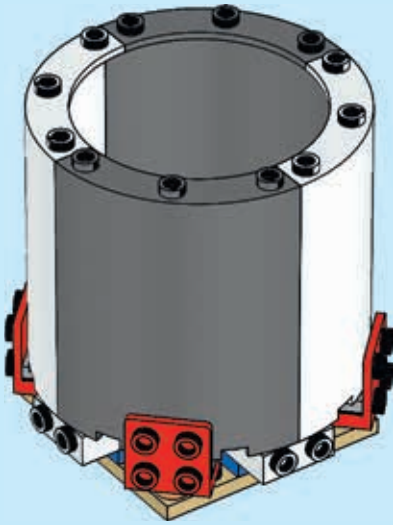

31

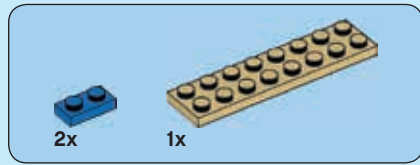
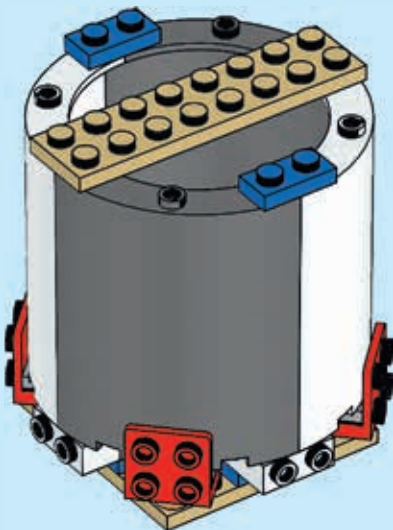

32

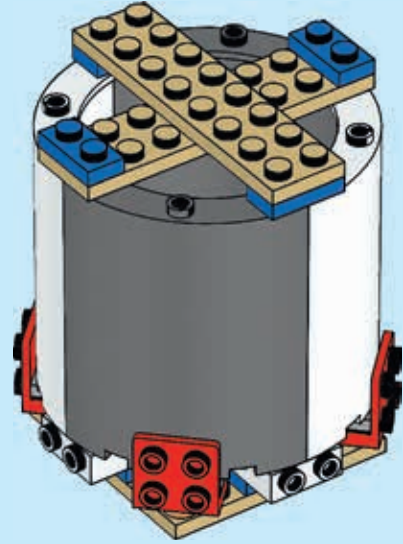

33

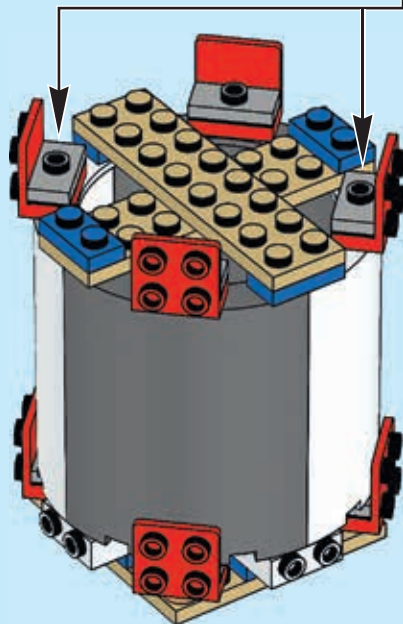
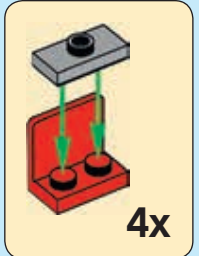



34

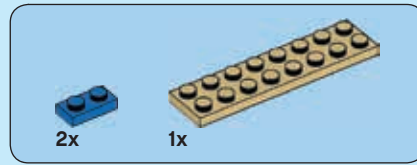
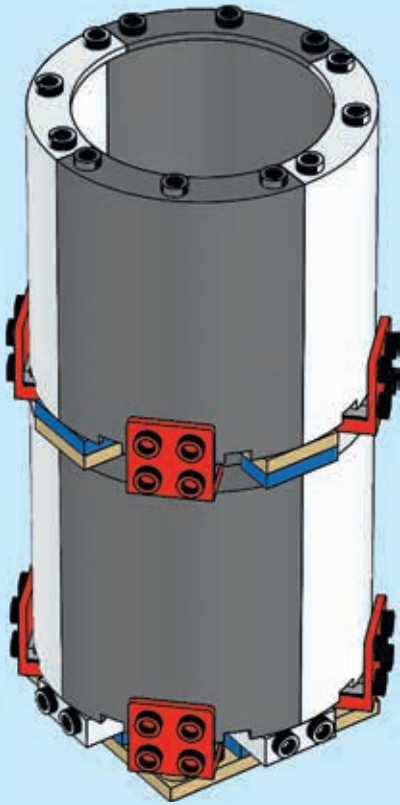

35

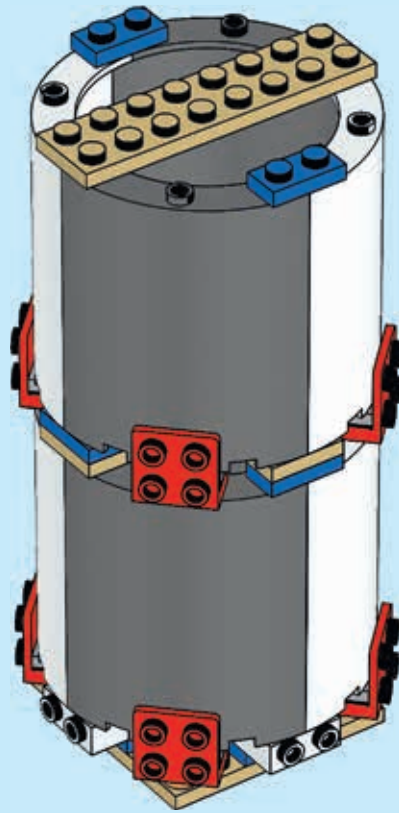

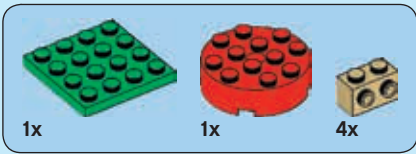

36

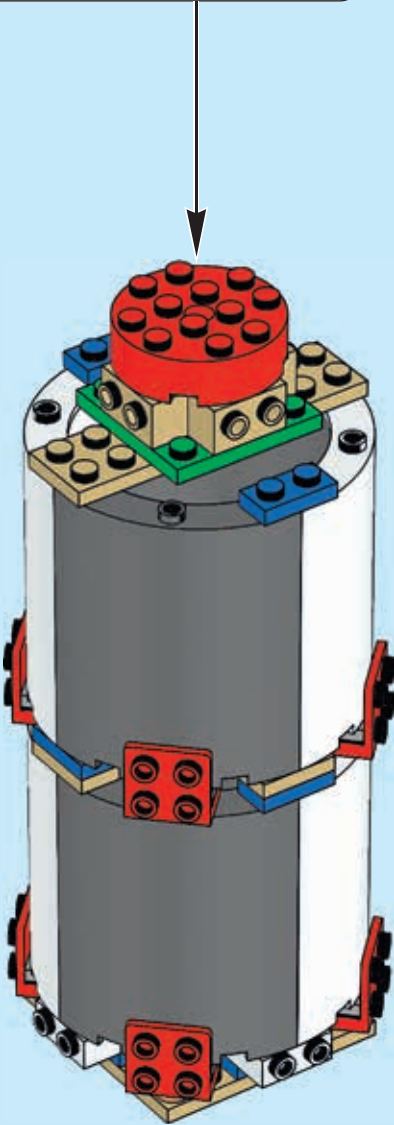
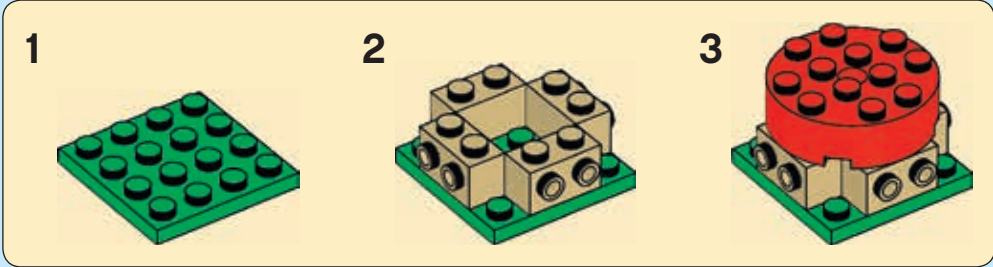

37

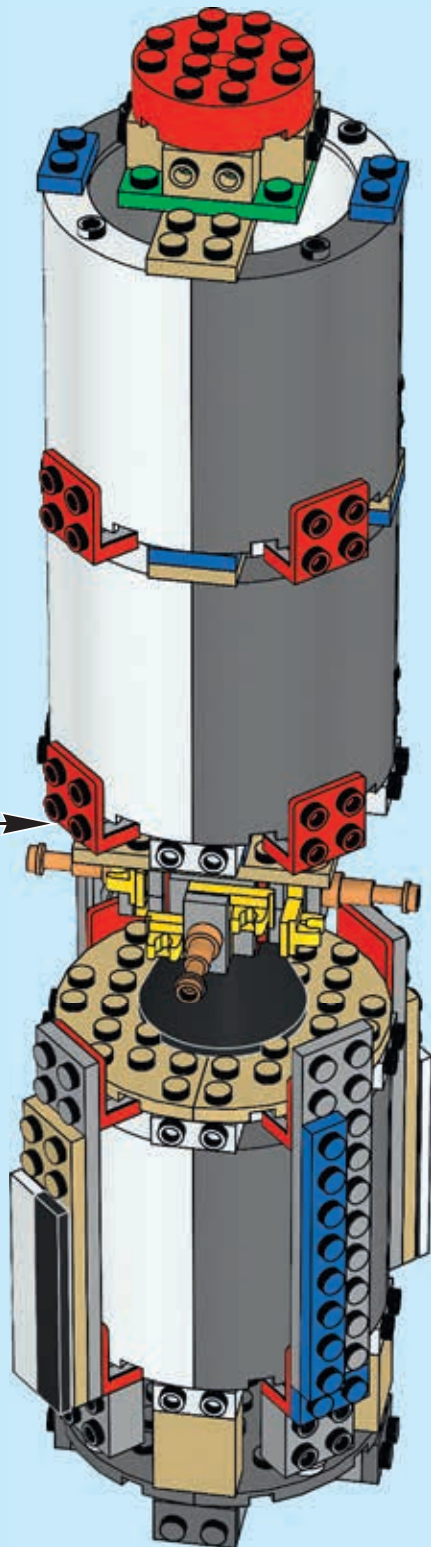

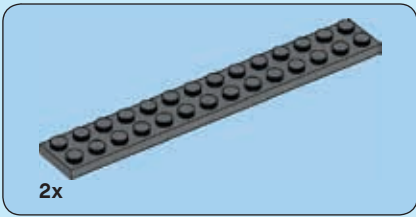
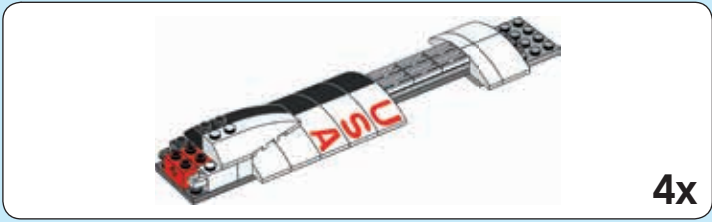
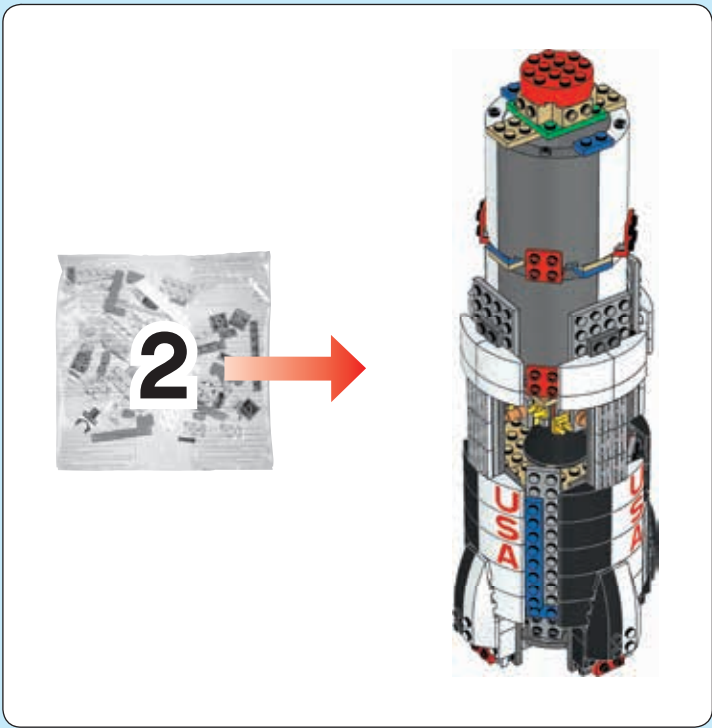

38

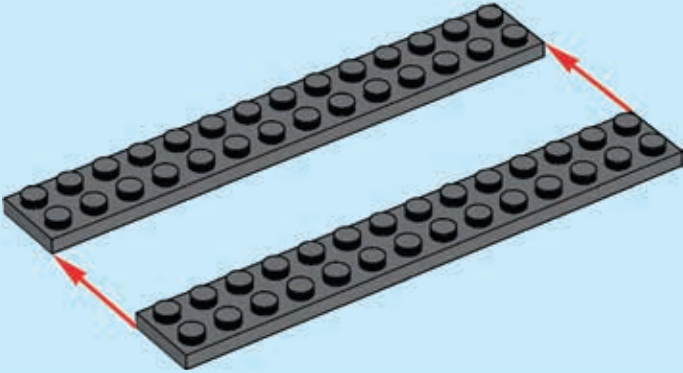

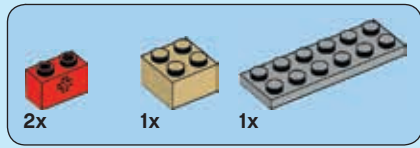

39

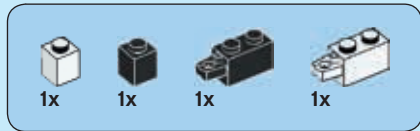
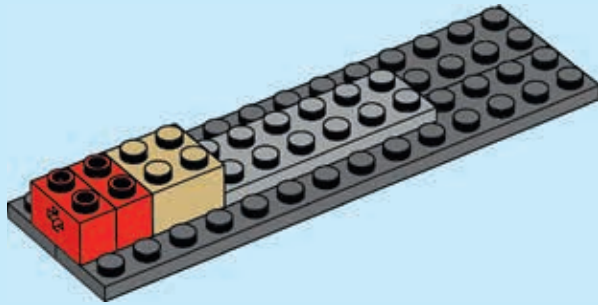

40

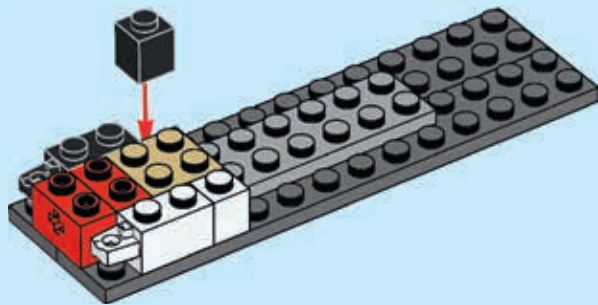

41

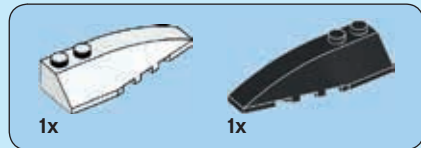
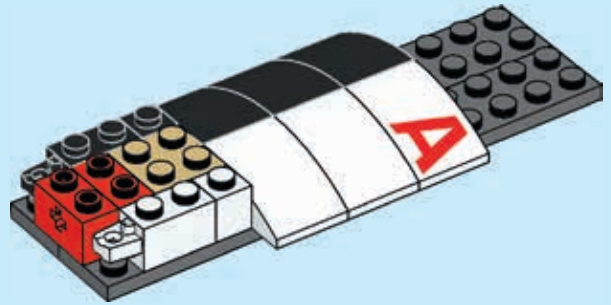

42

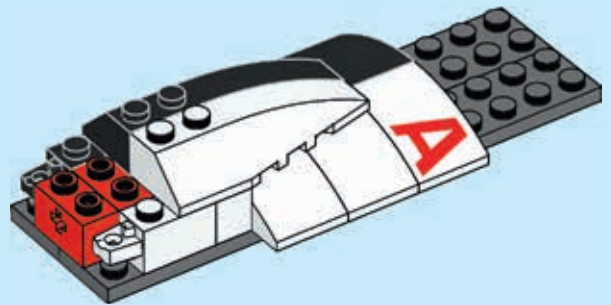

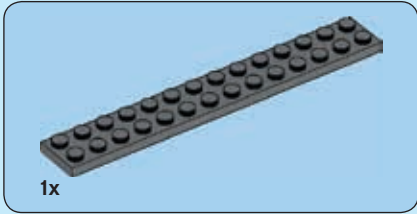

43

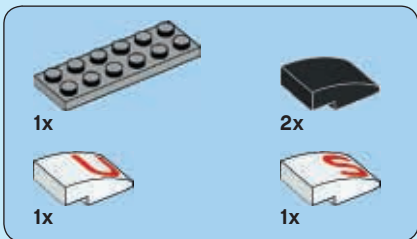
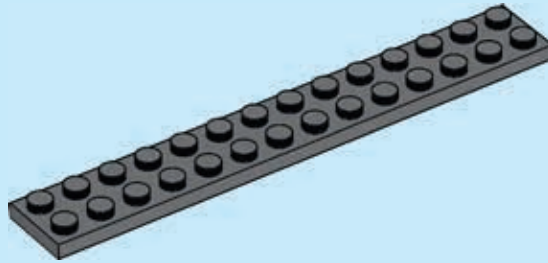

44





6x

45

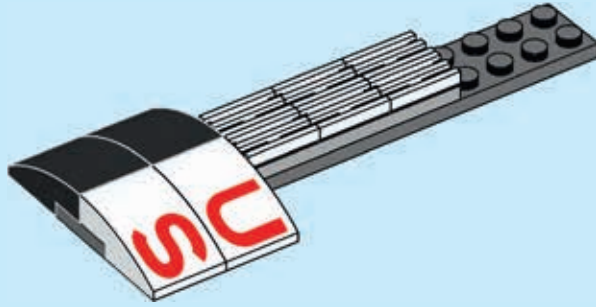

1x

46

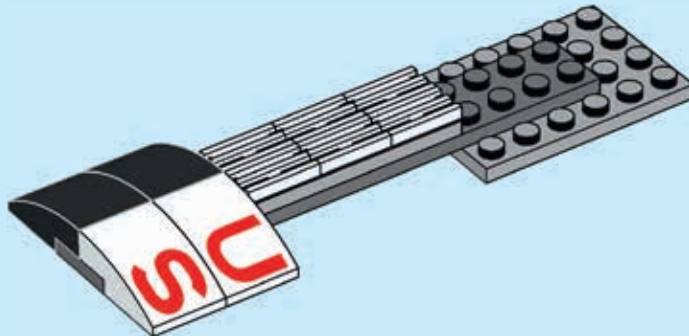

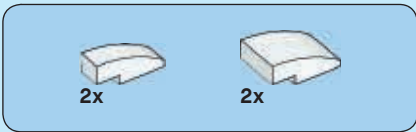

47

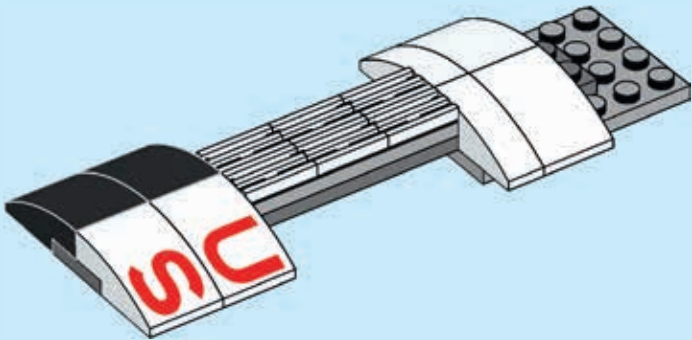

48

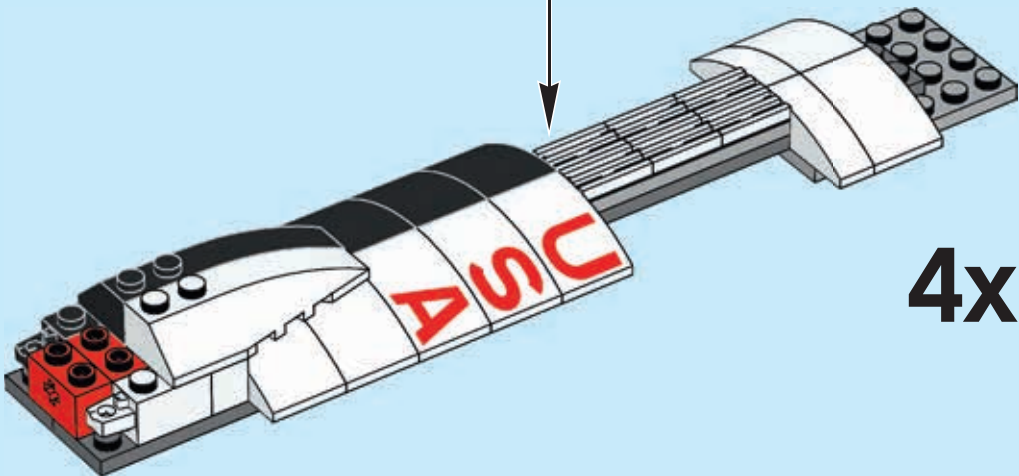

49

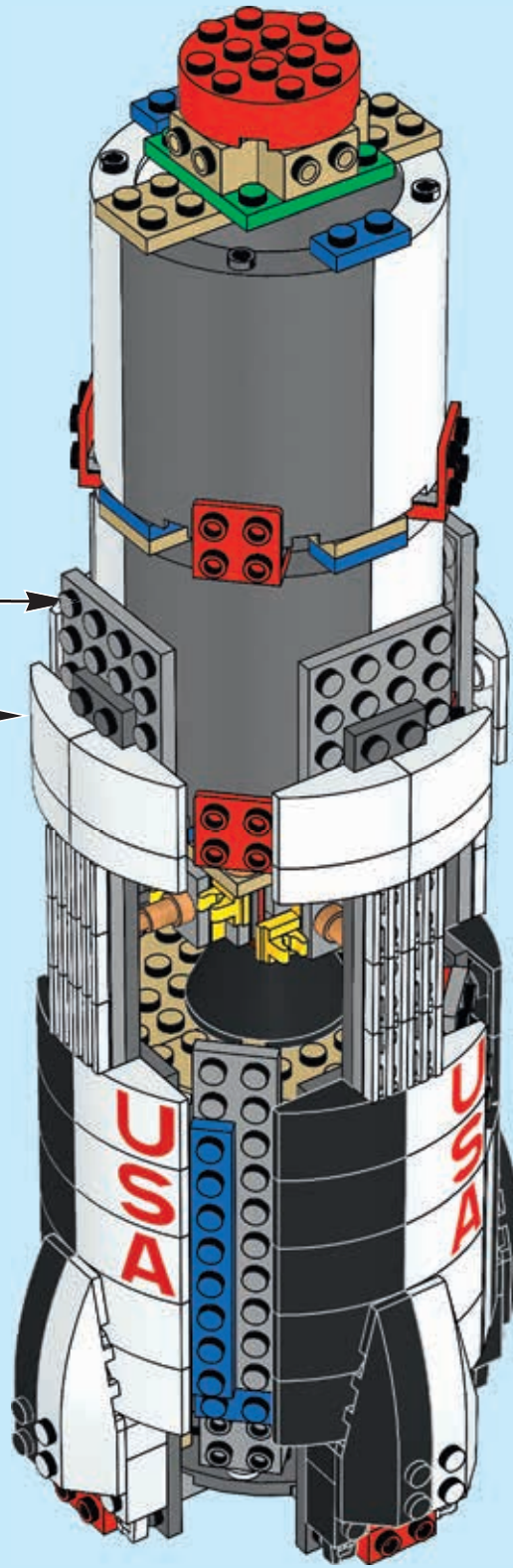

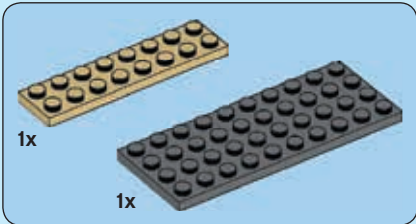
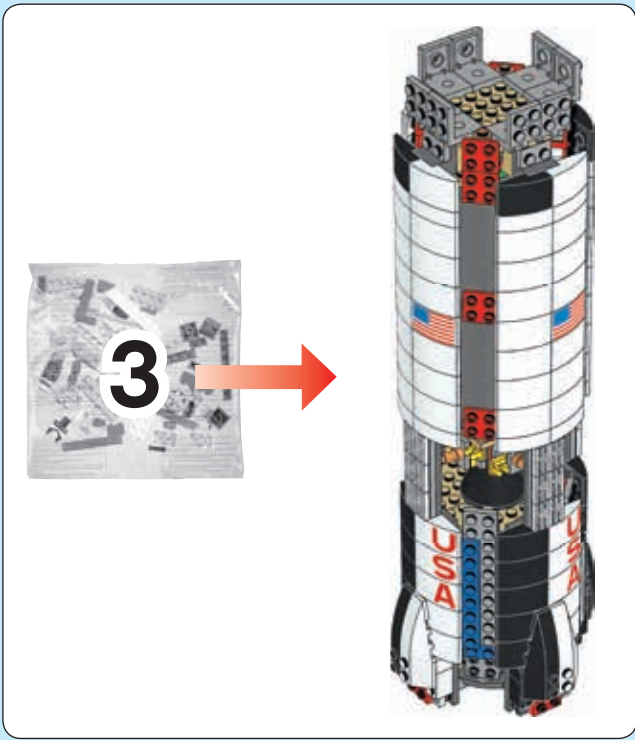

50

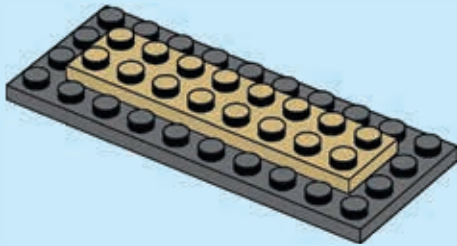

51

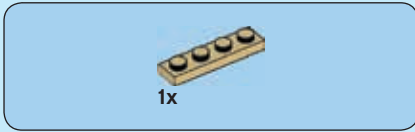
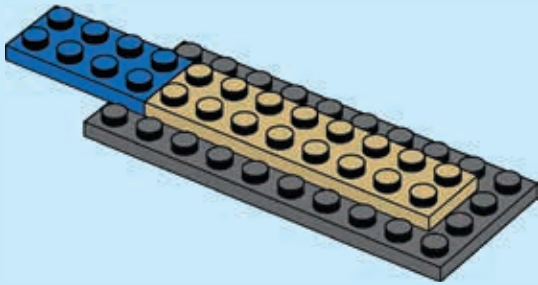

52

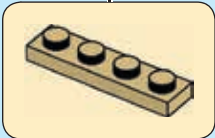
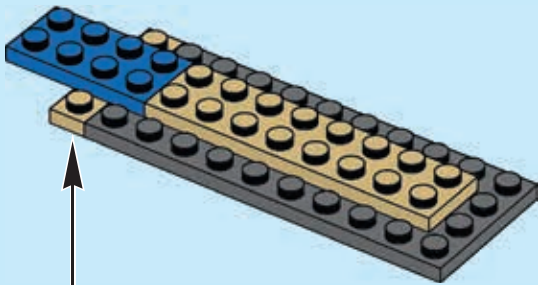



2x

53

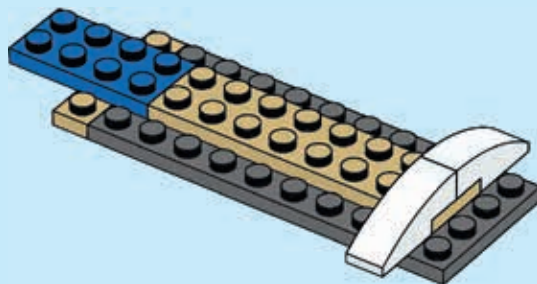

9x



1x

54

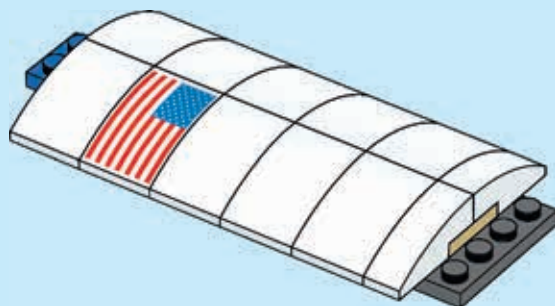

4x

55

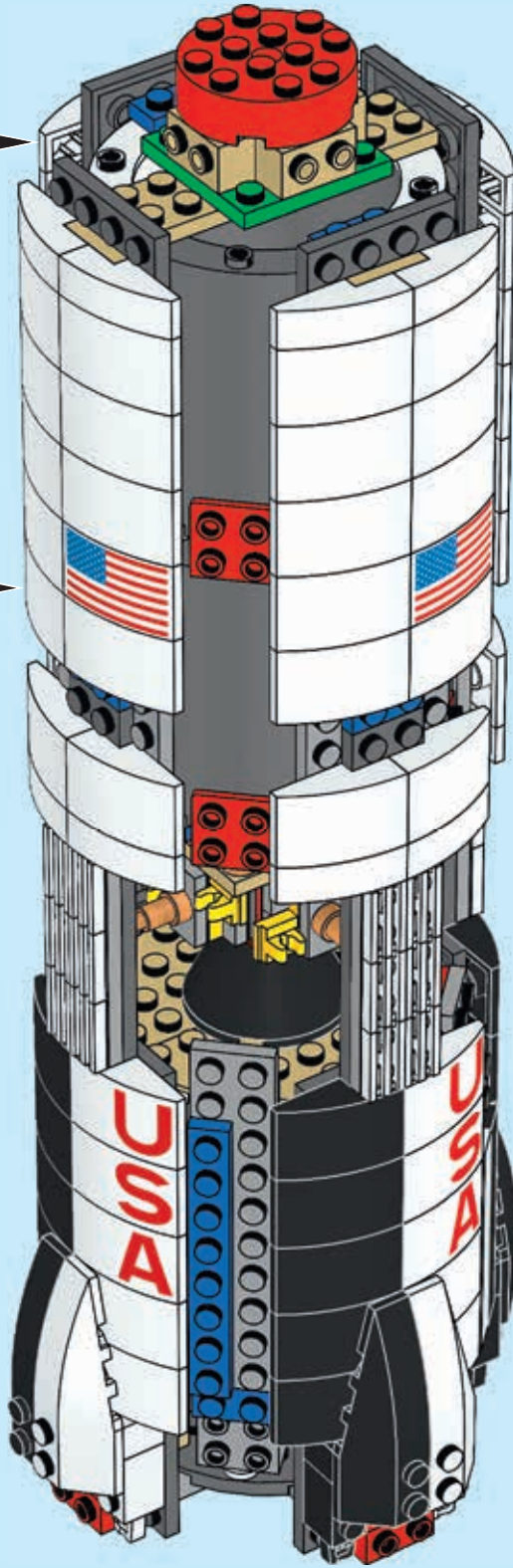

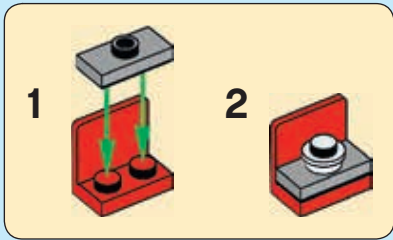
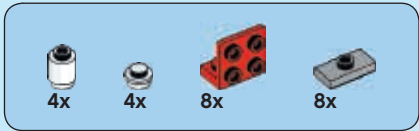

56

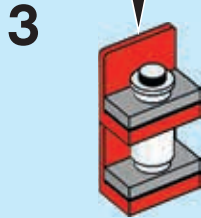
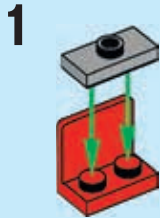

4x

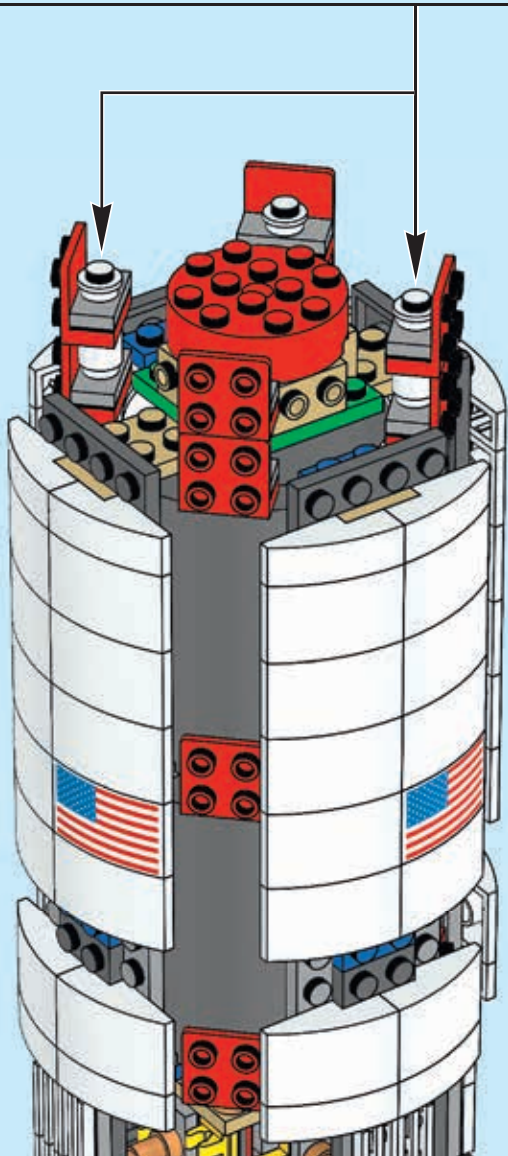



57

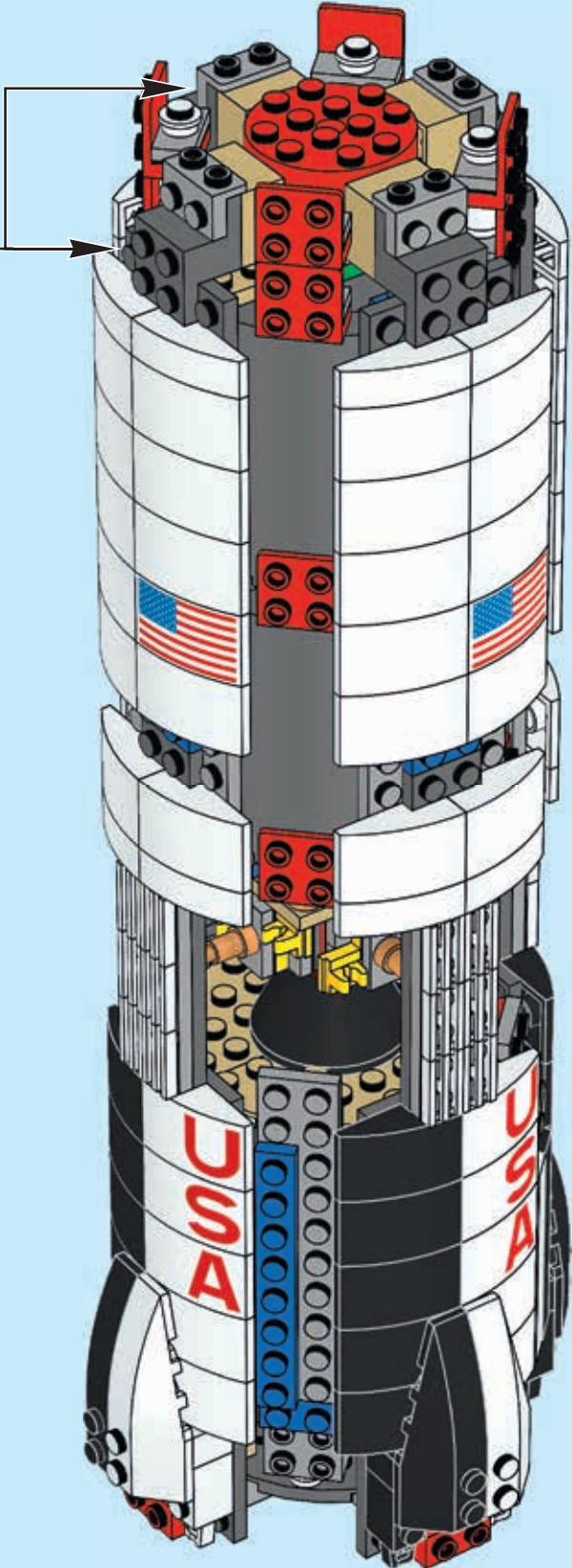
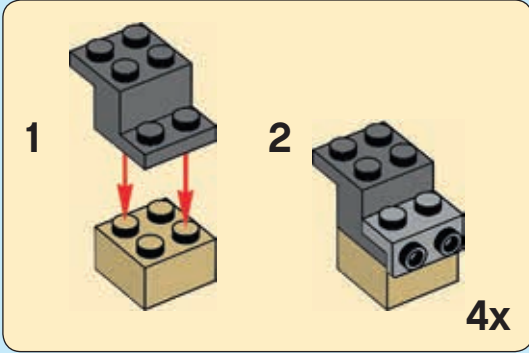

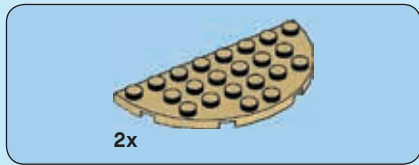

58

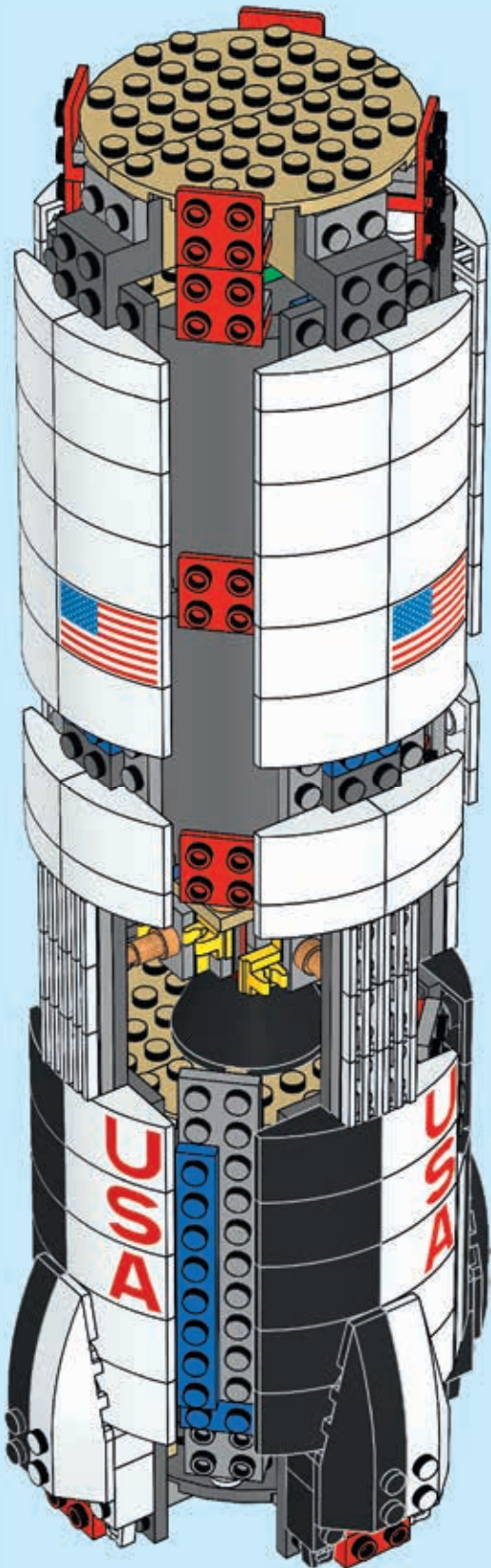

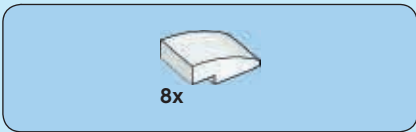

59

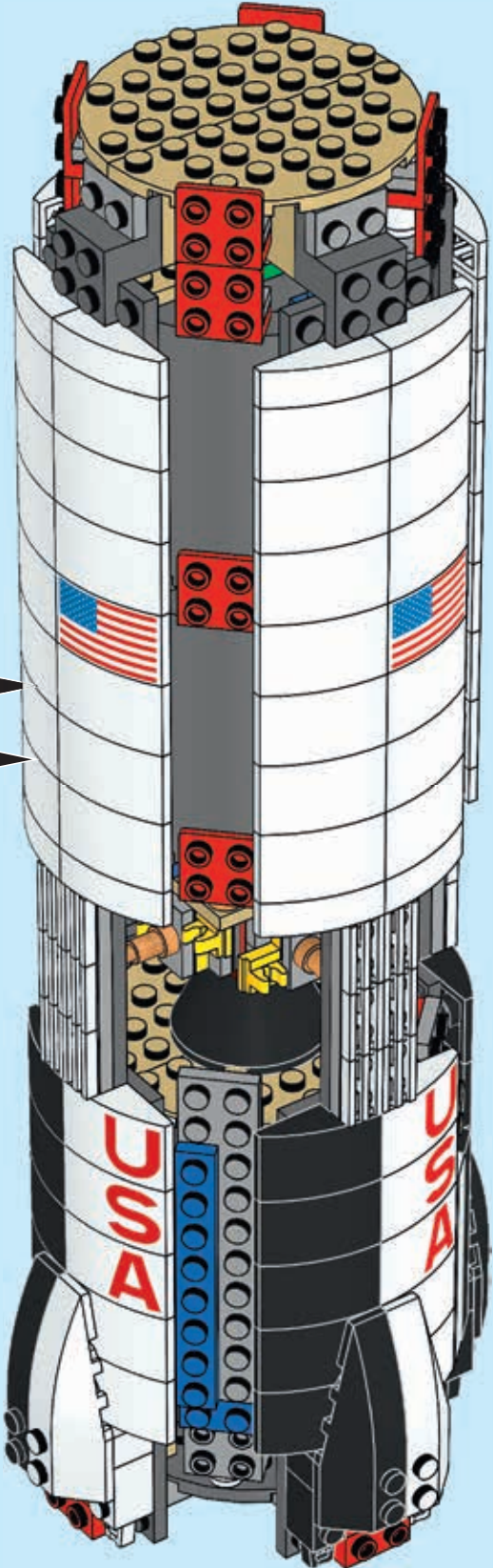
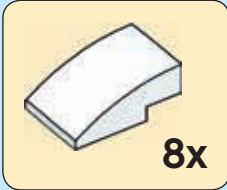

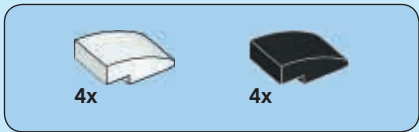

60

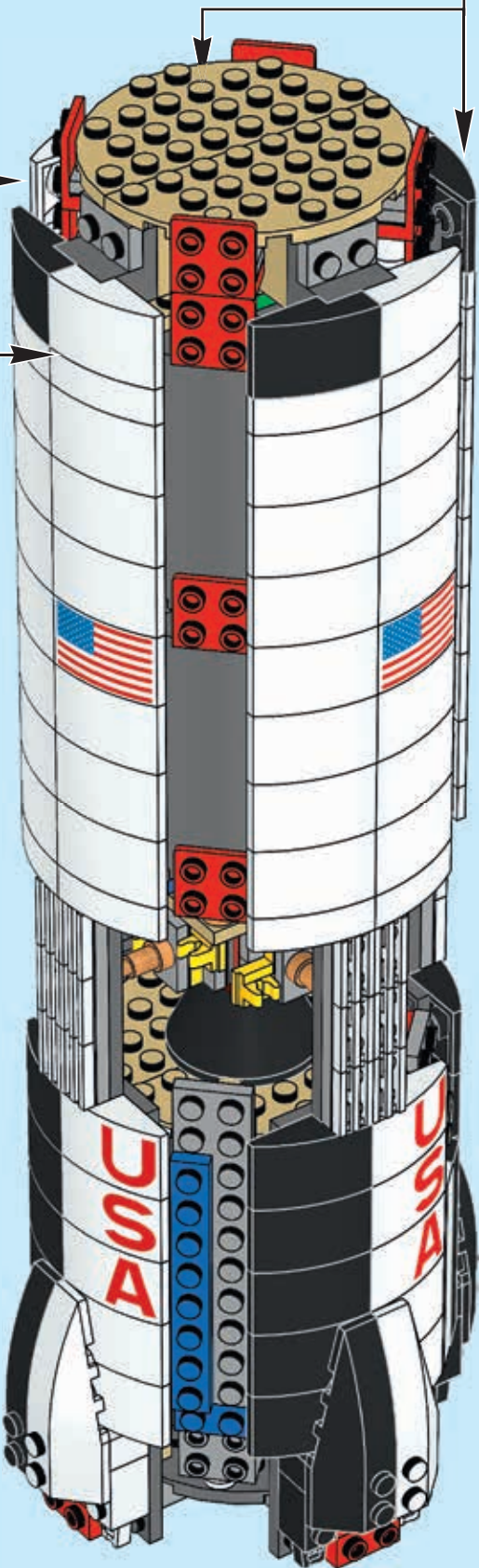



4x

61

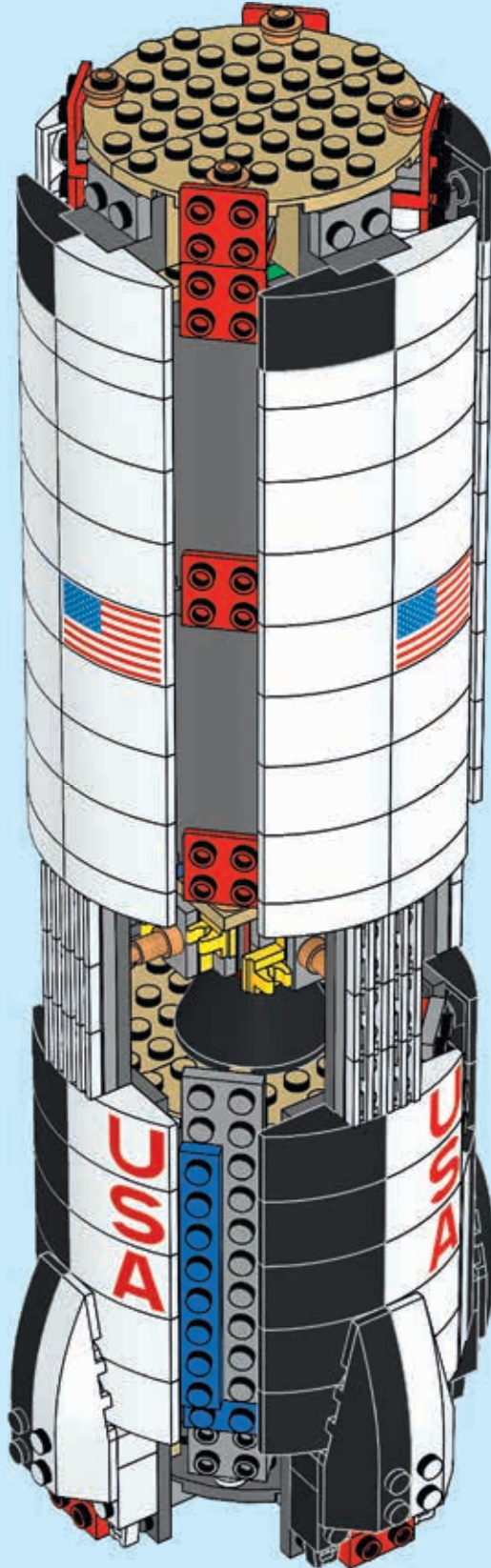



8x

62

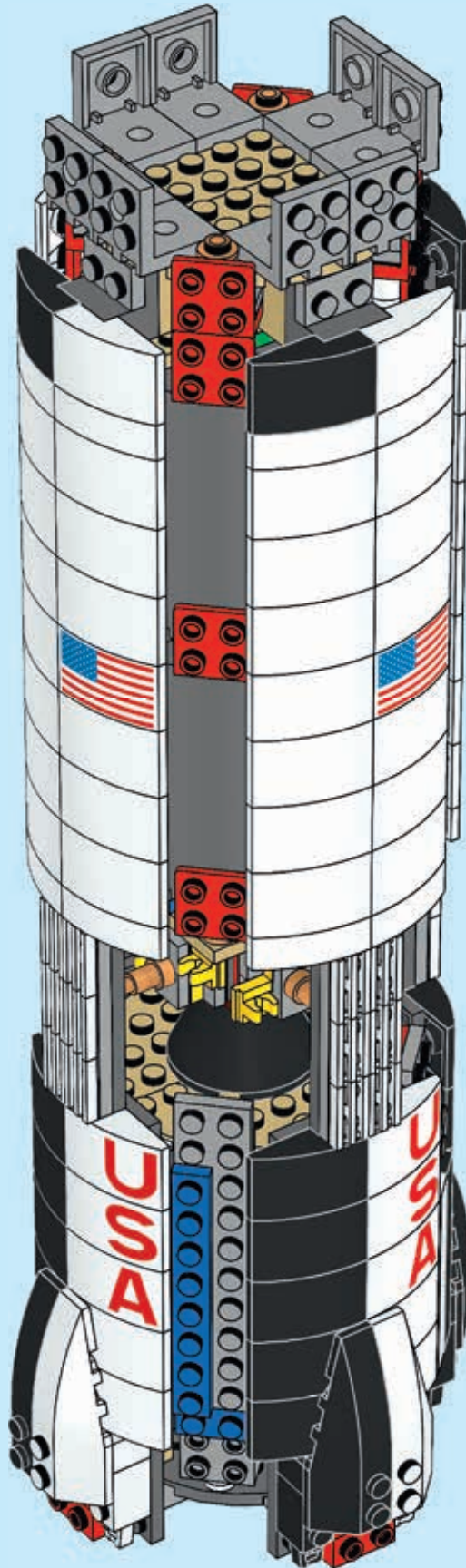



4

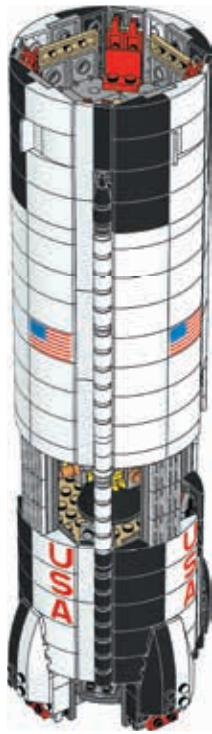

4x

63

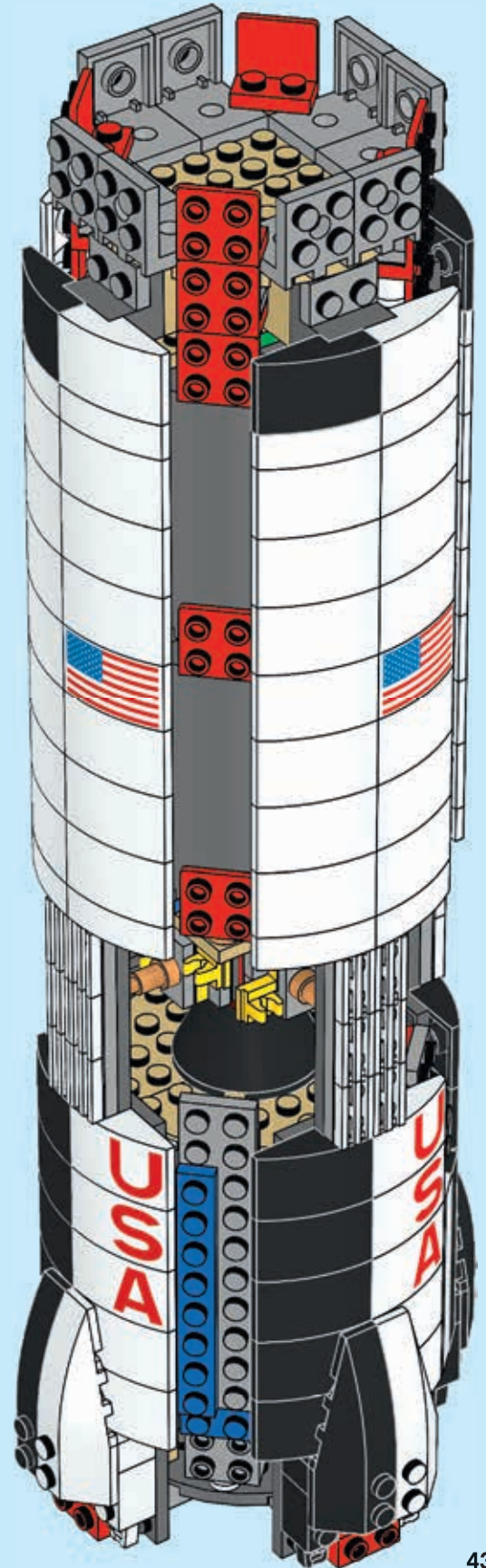

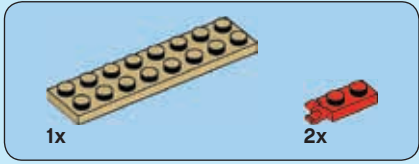
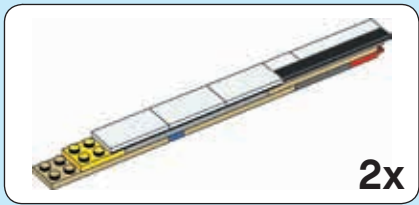

64

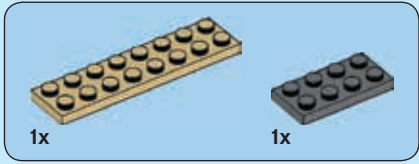
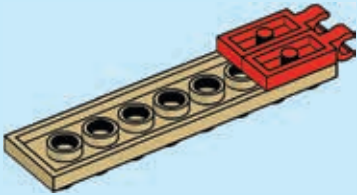

65

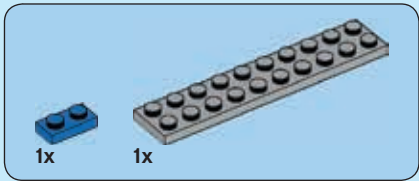
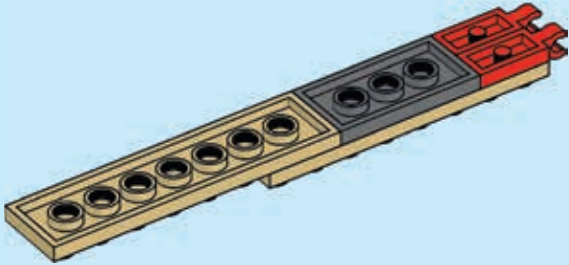

66

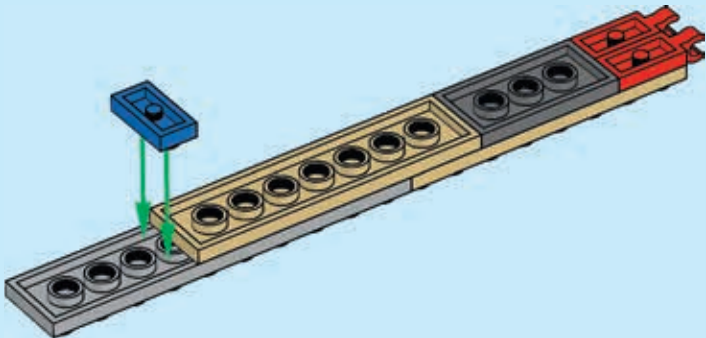

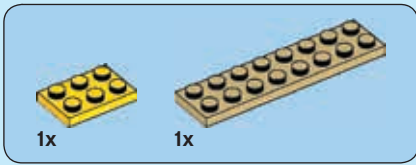

67

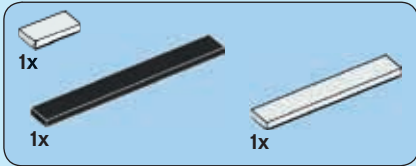
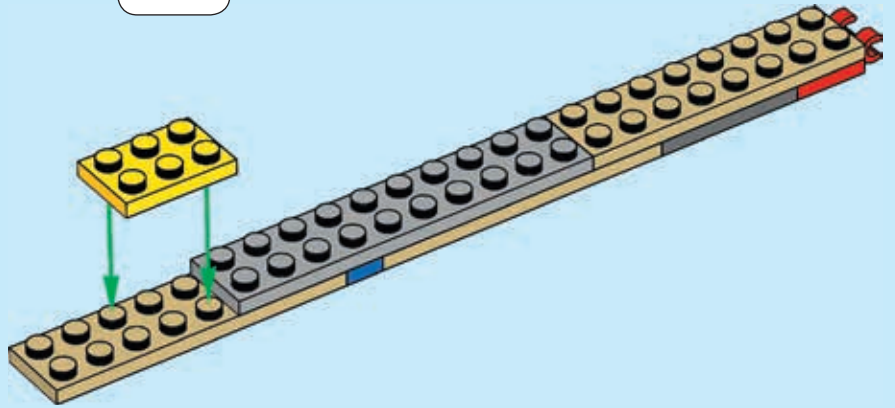

68

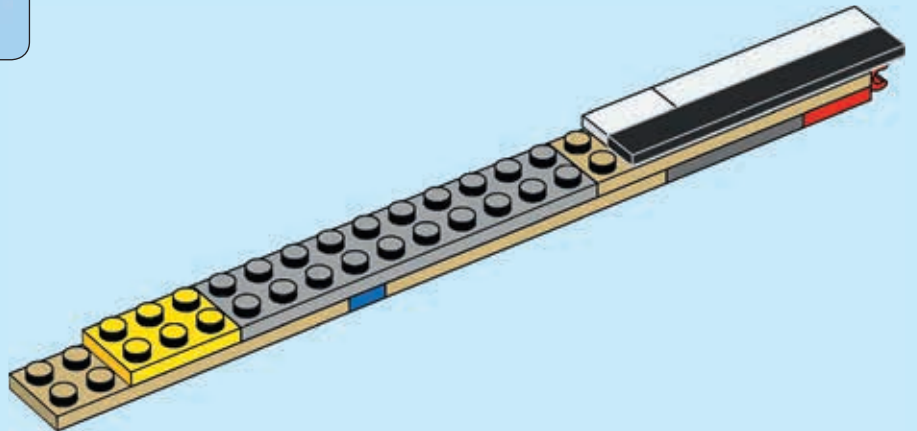

69

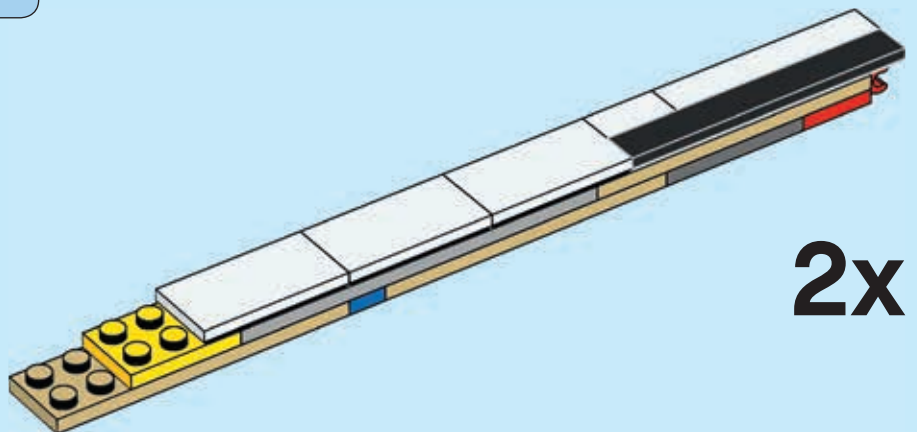

2x

70

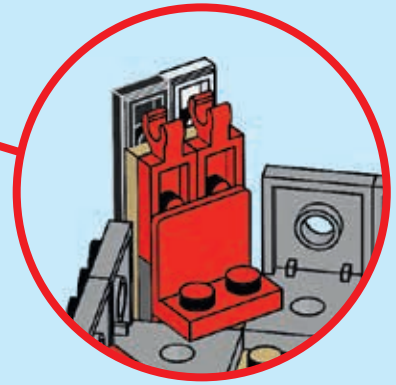
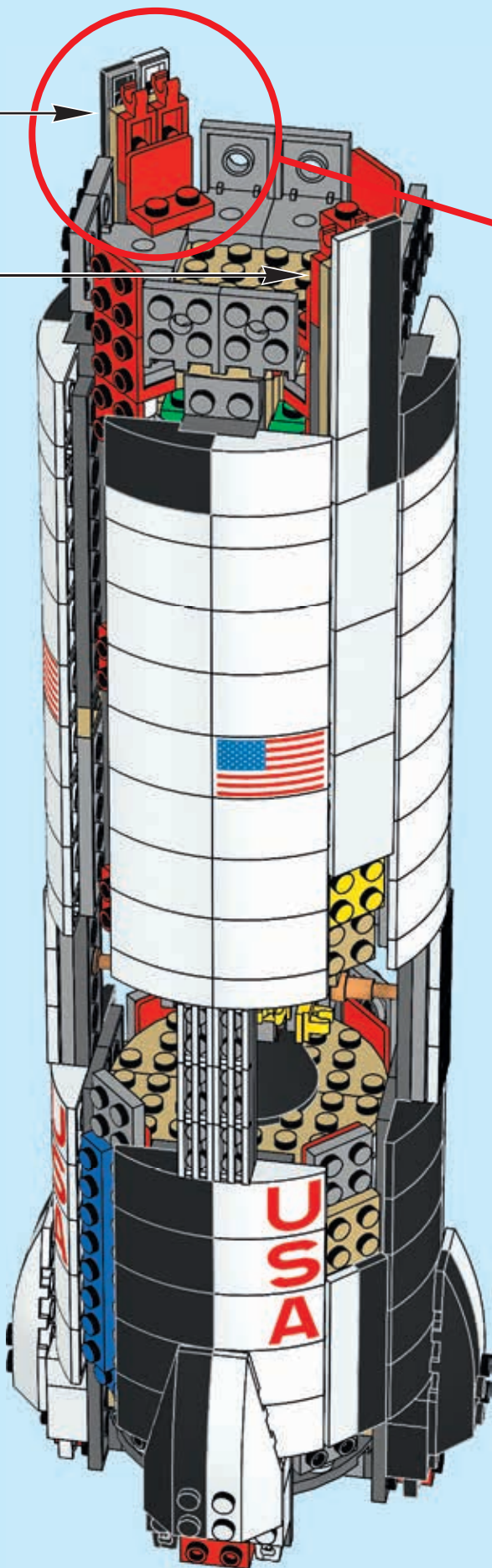

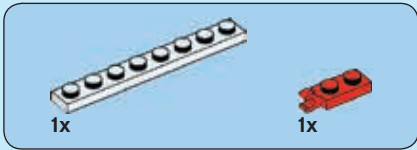
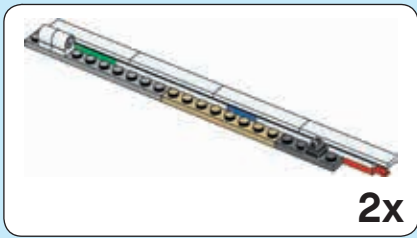

71

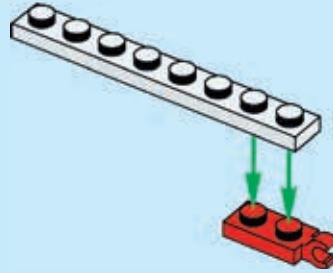

72

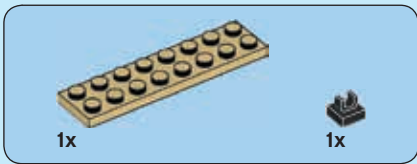
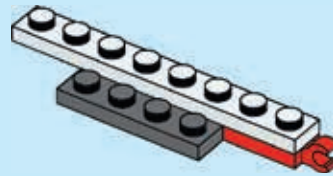

73

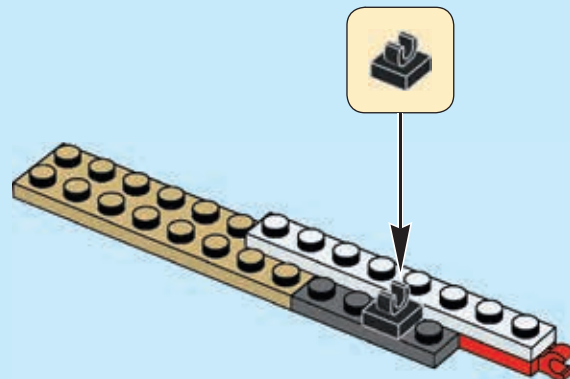

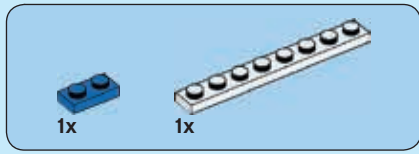

74

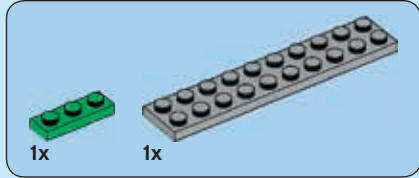
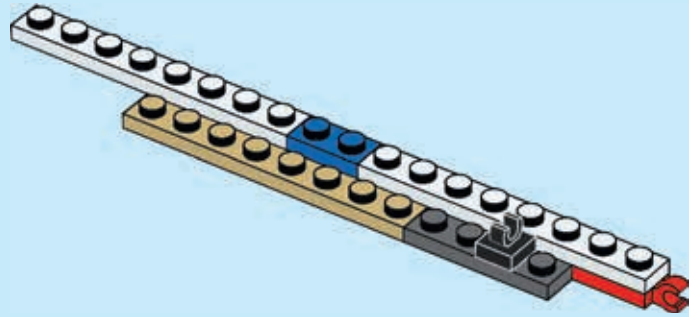

75

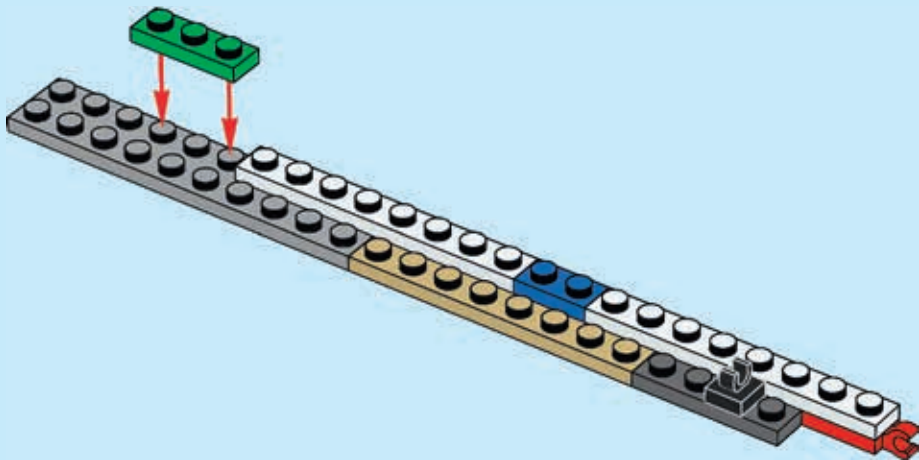



76

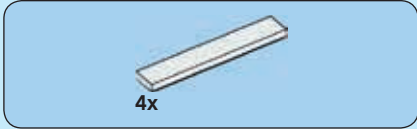
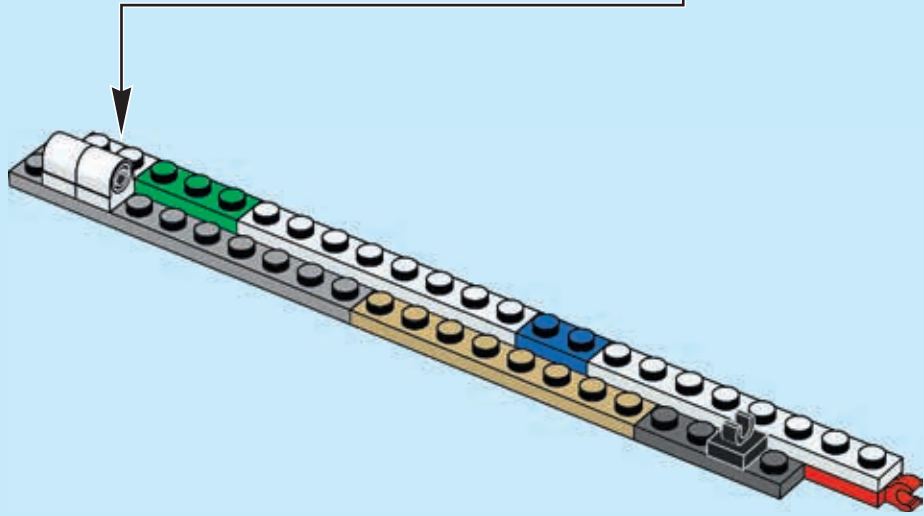
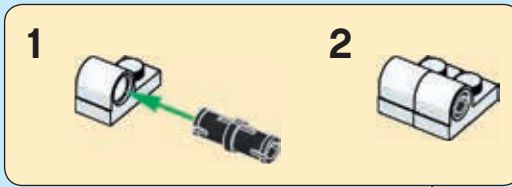

77

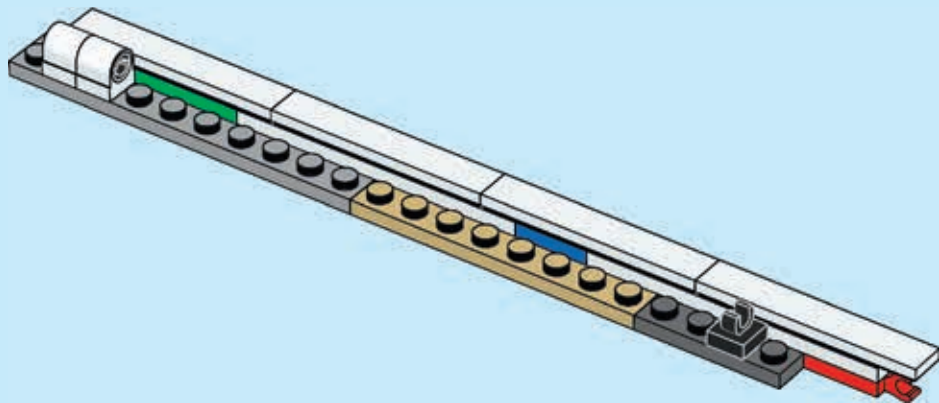

2x

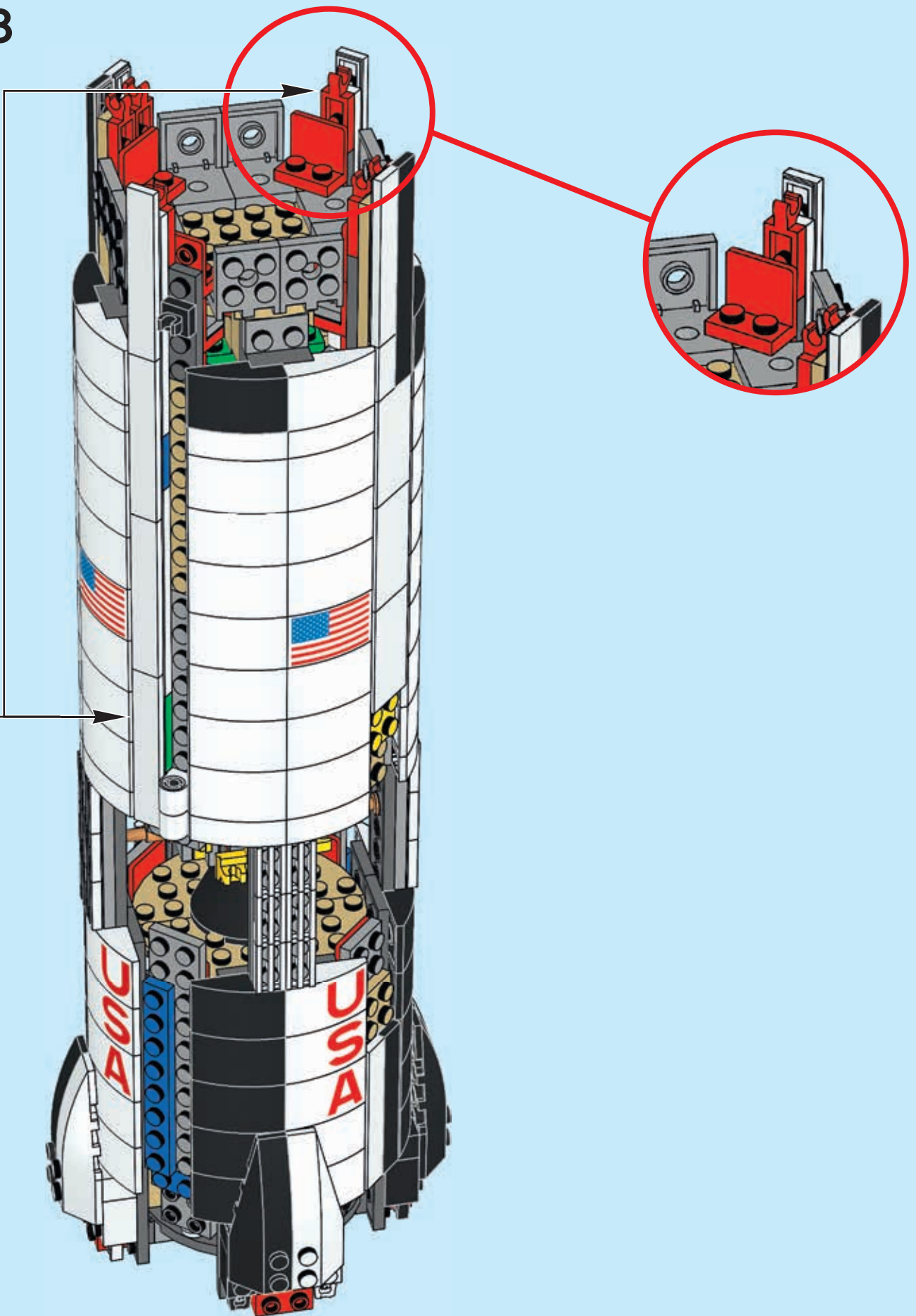

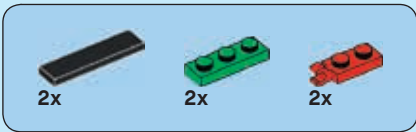

79

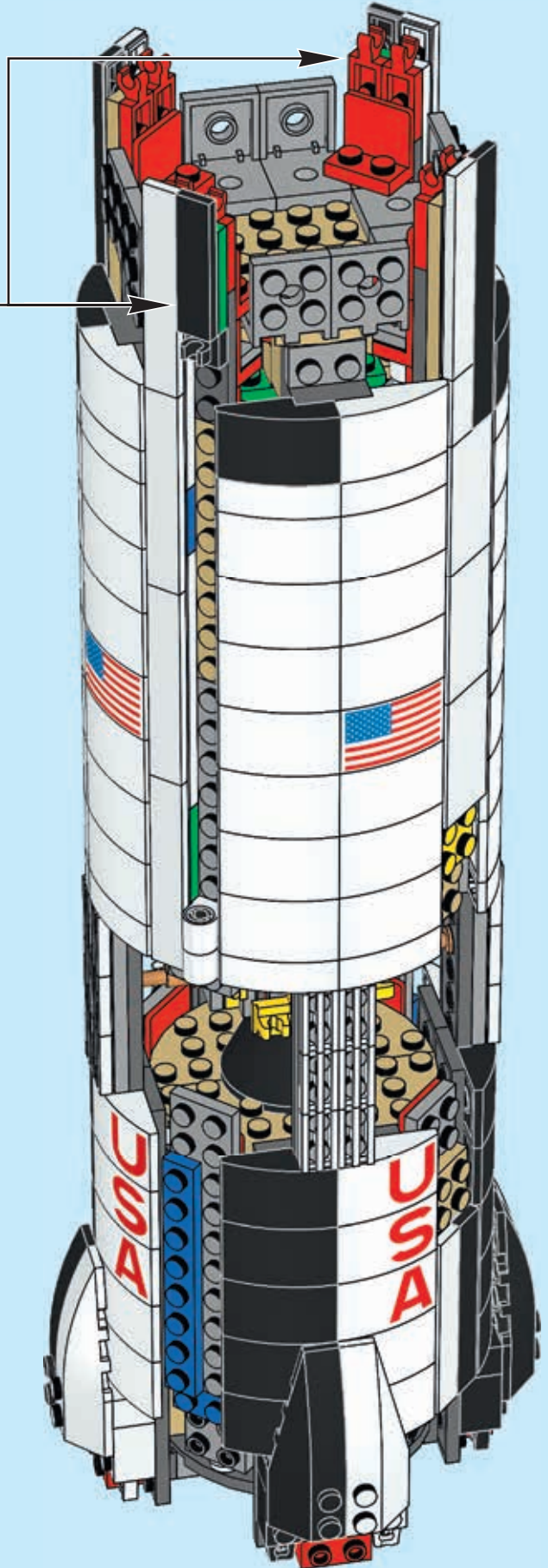
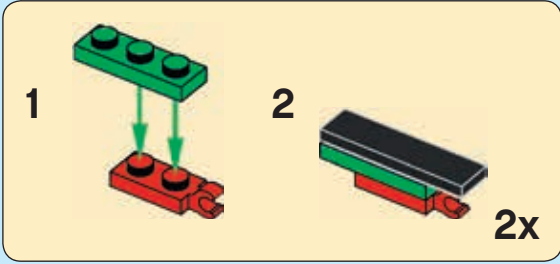

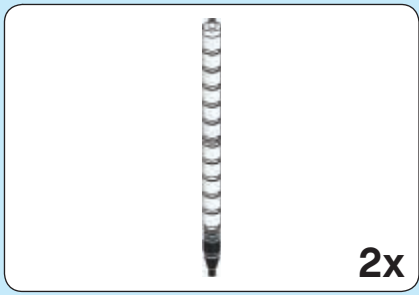

80

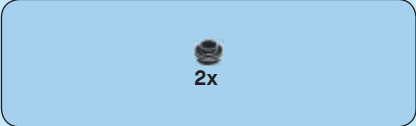

81

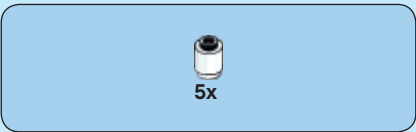

82

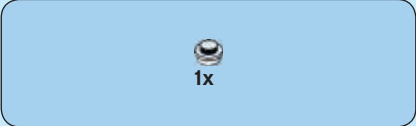

83



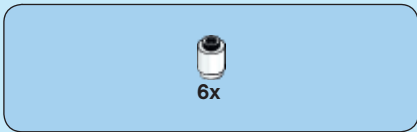

84

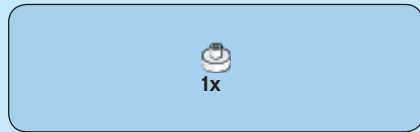

85



2x

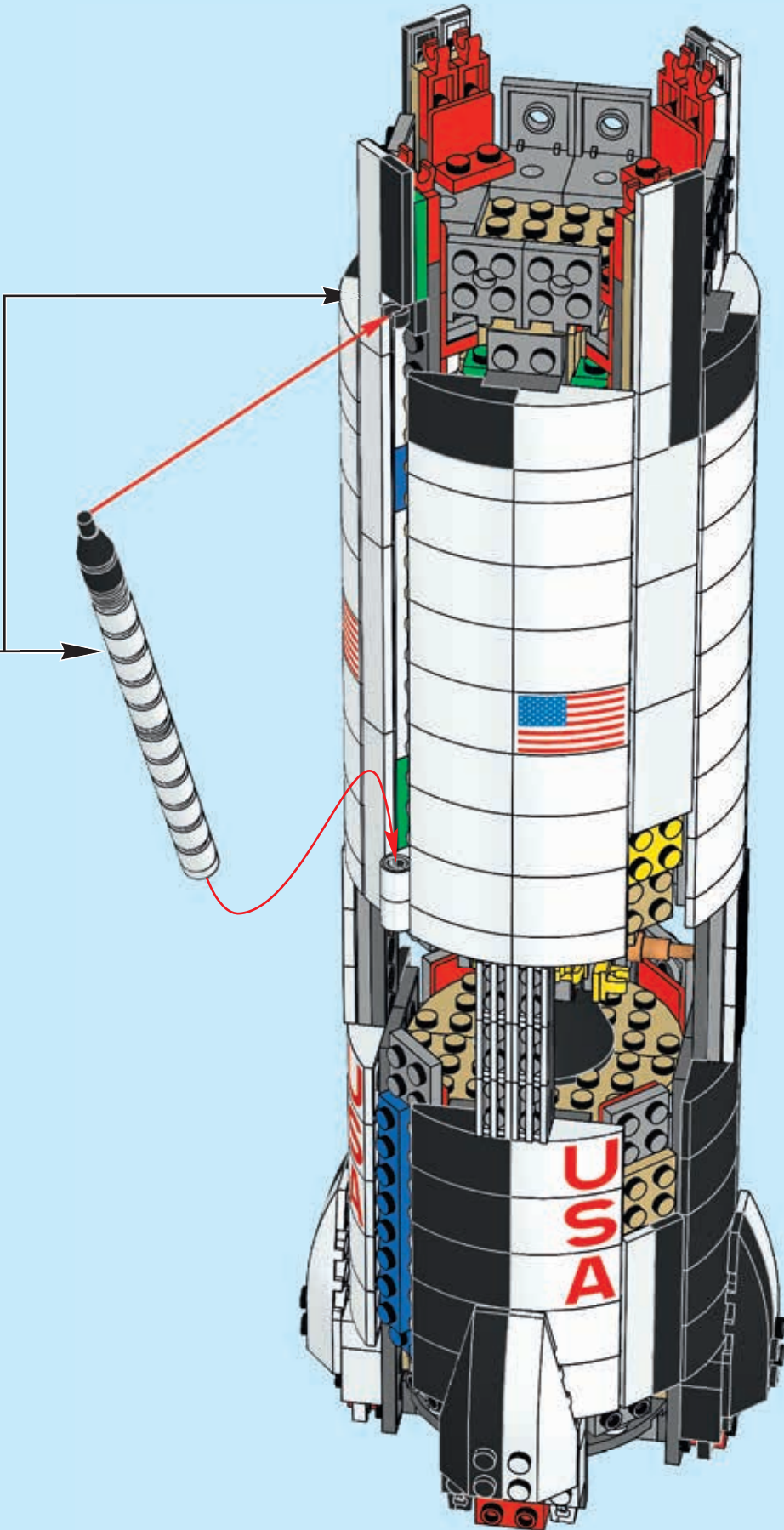

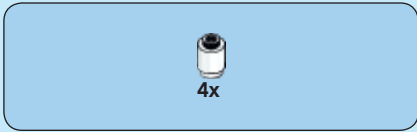

87

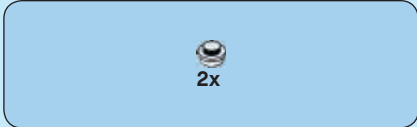

88

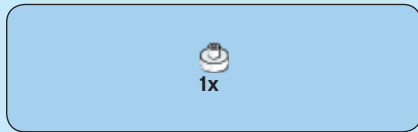

89

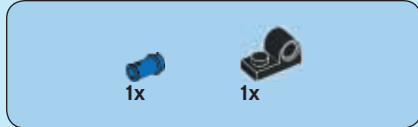

90

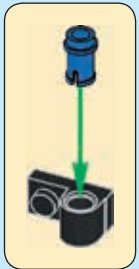

2x

91

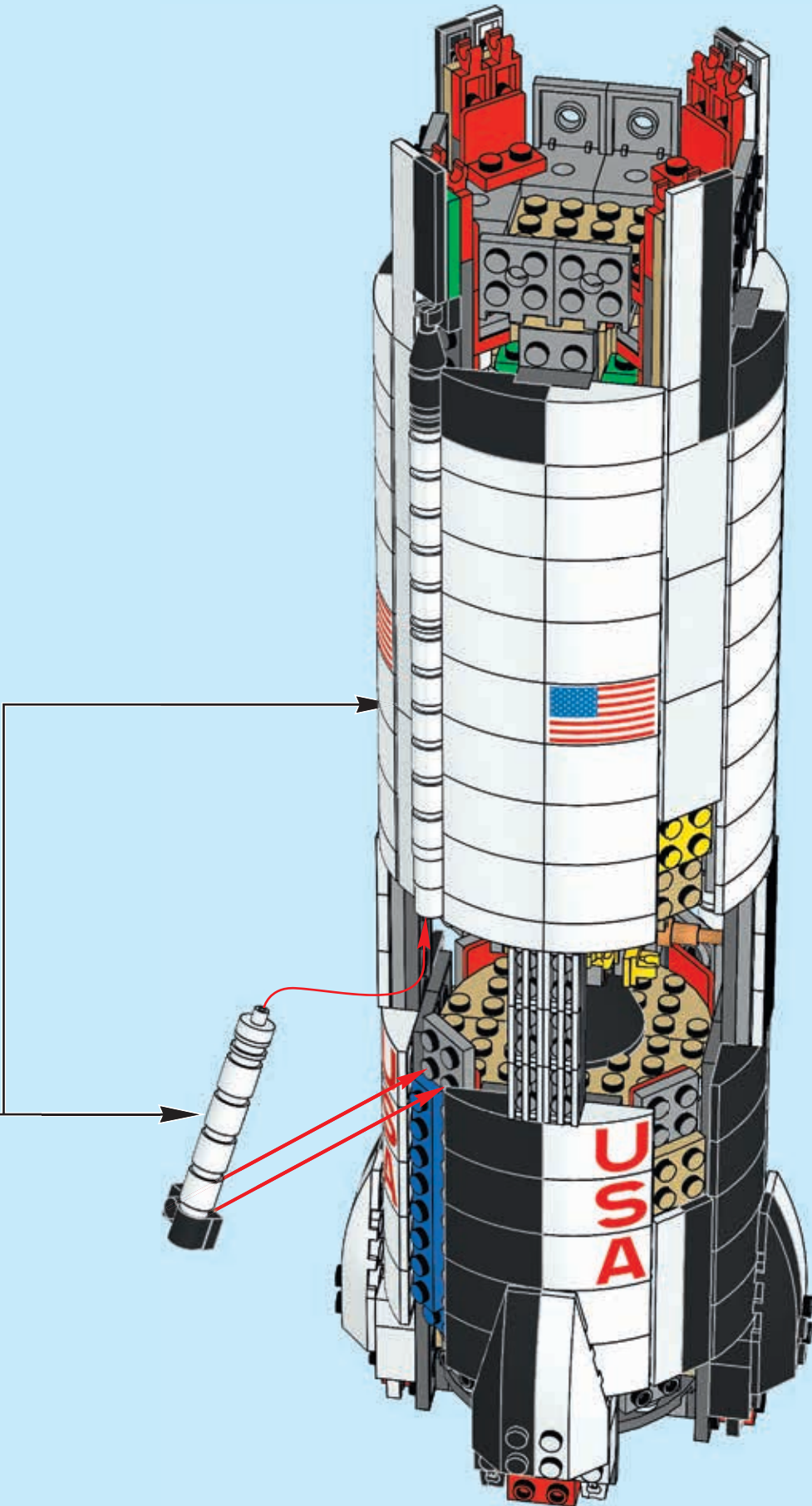

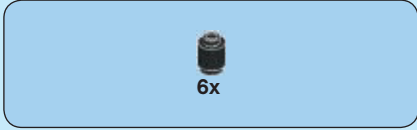

92

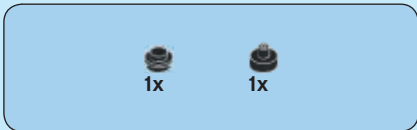

93



94

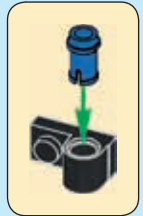

2x

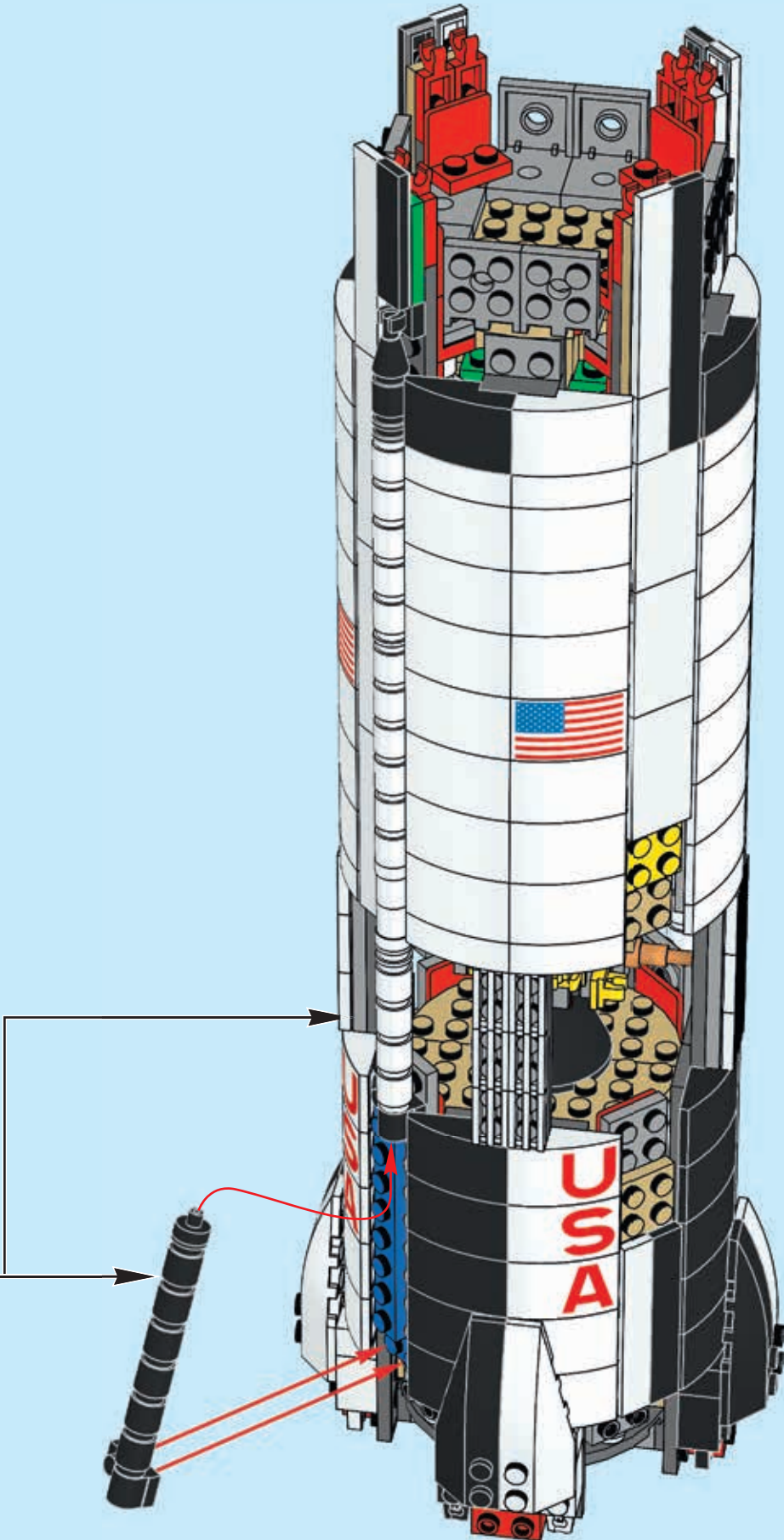

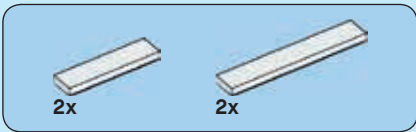

96

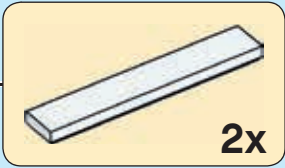
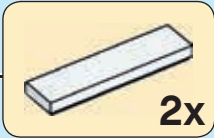
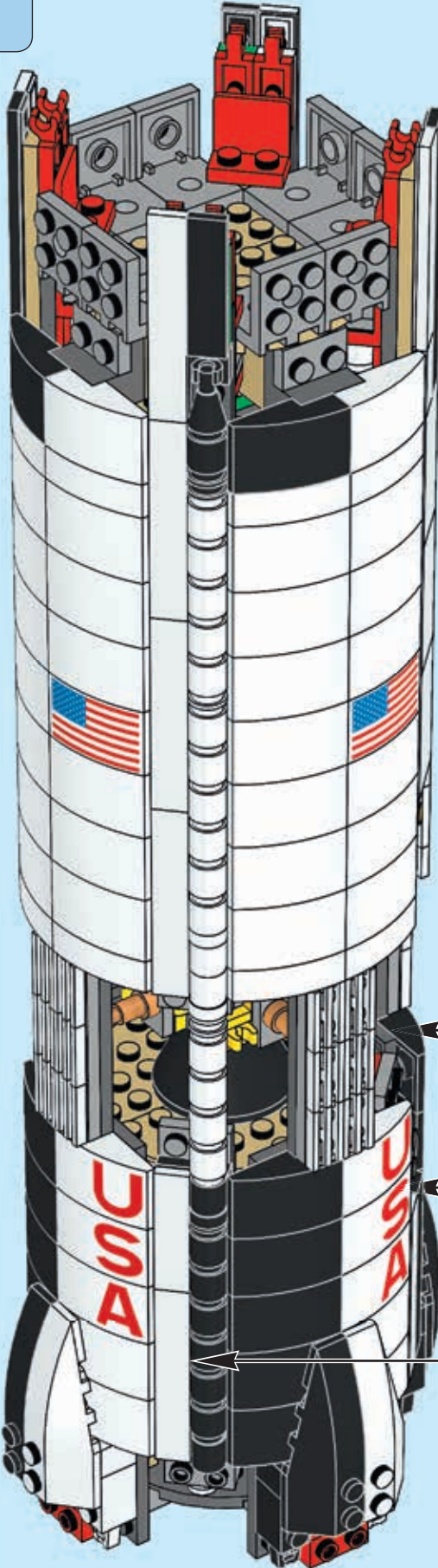



4x



1x

97



2x

98

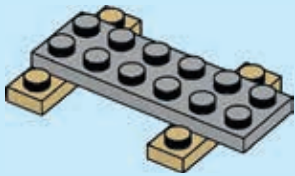

3x

99

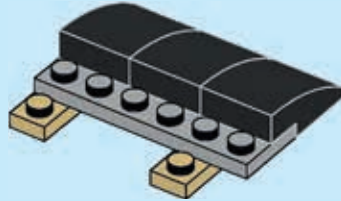

2x

1x

100

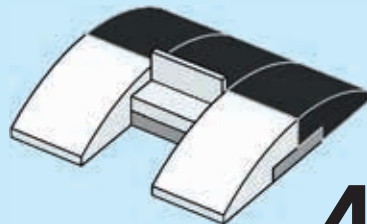

4x

101

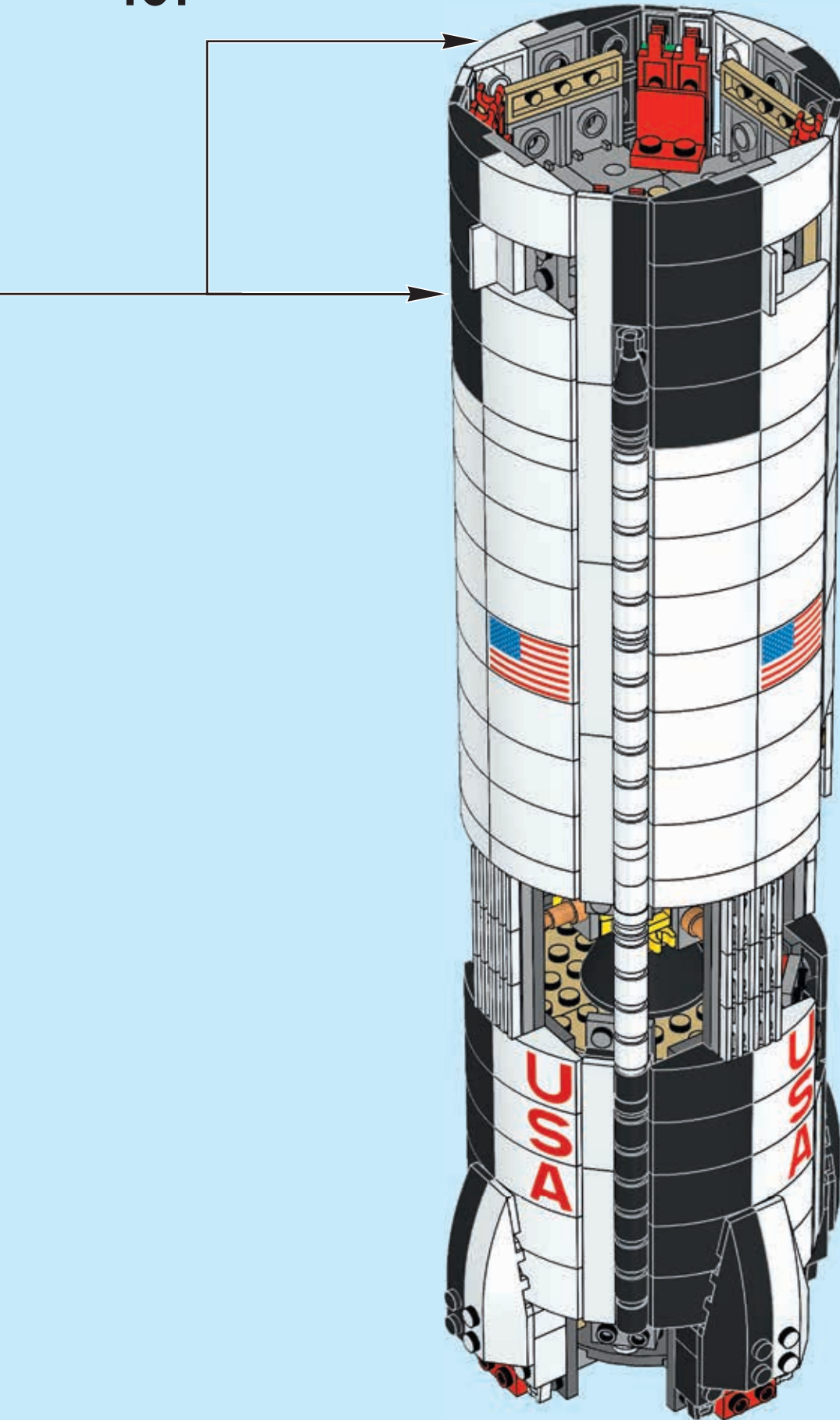

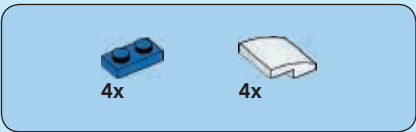

102

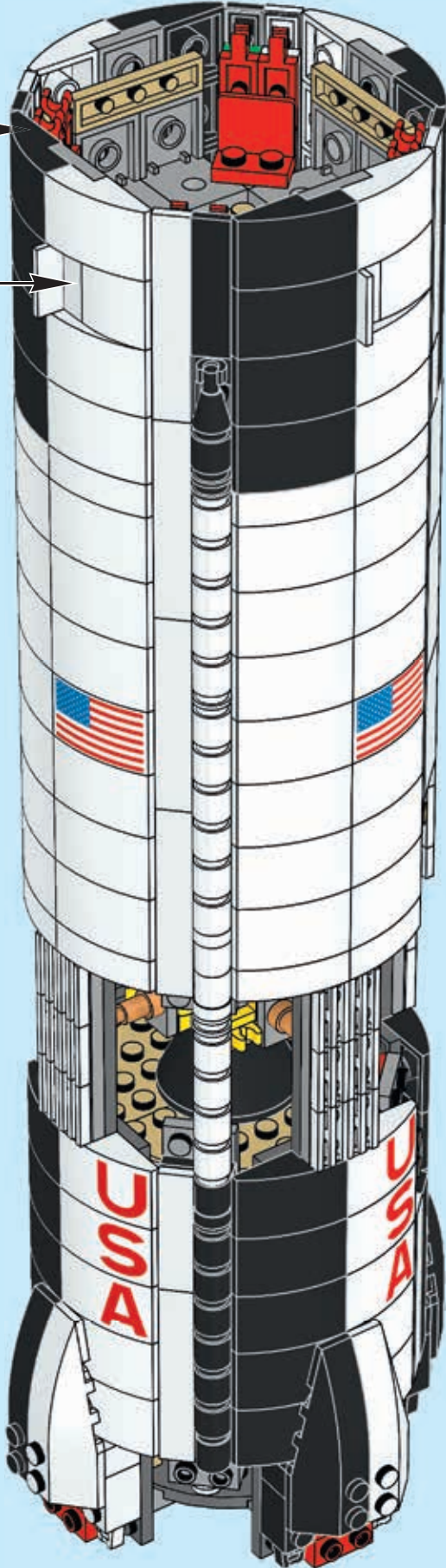
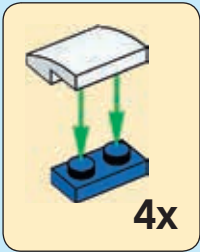

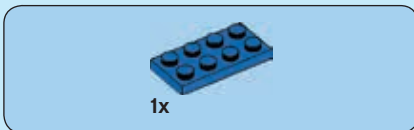
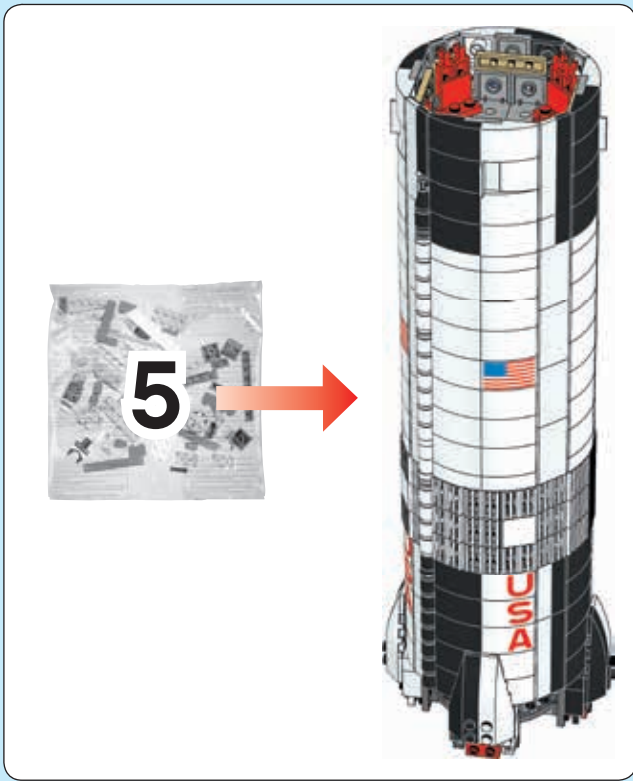

103

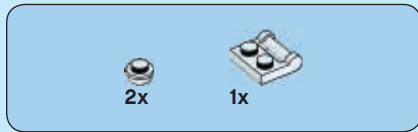

104



105

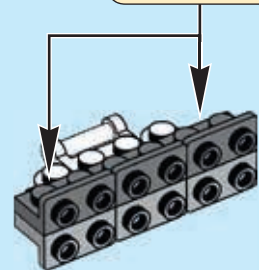
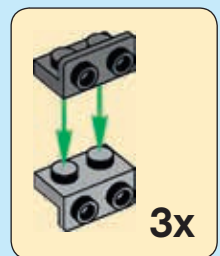



2x

106

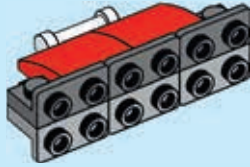

4x



1x

107

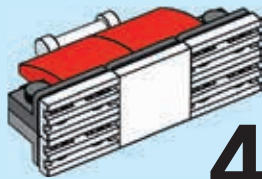

4x

108

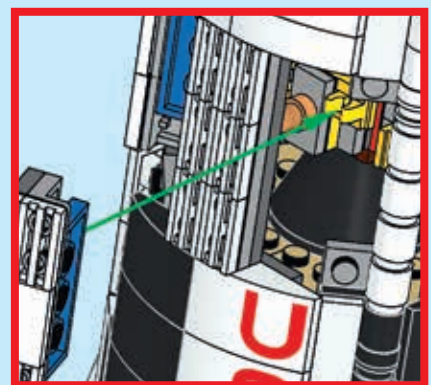
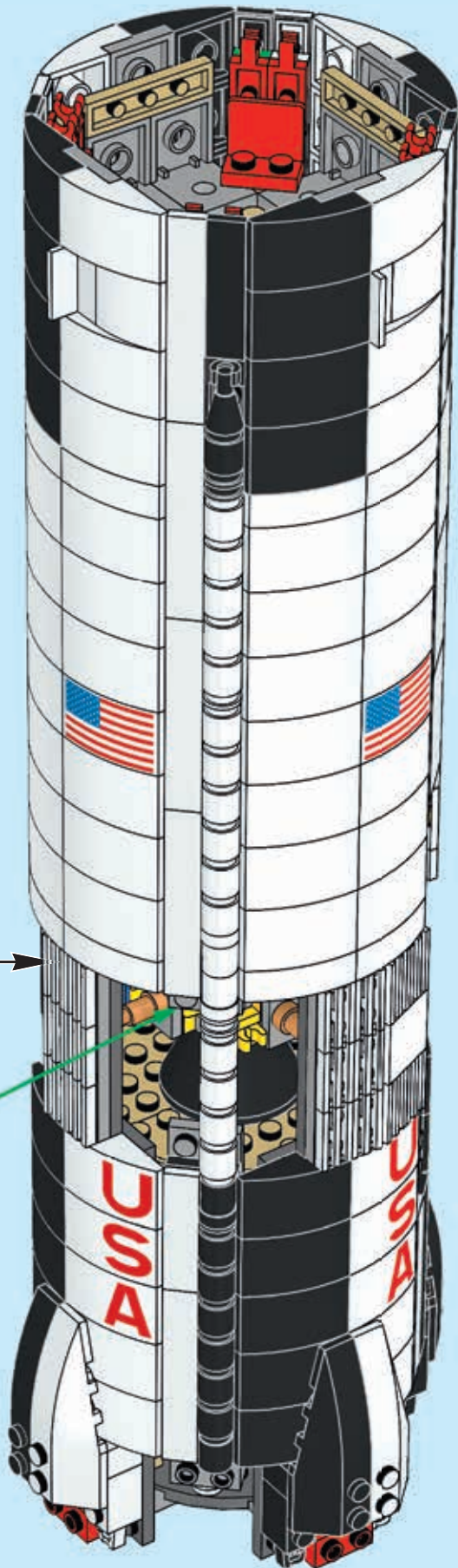



109



110

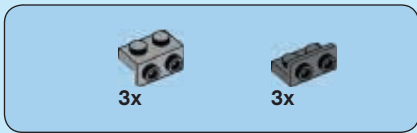

111

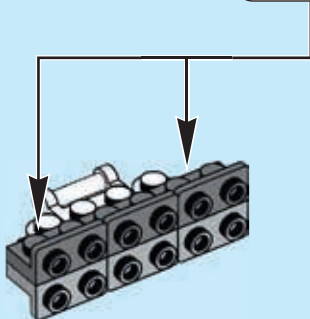
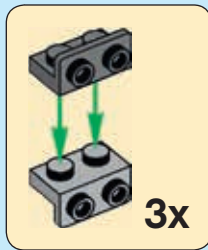

112

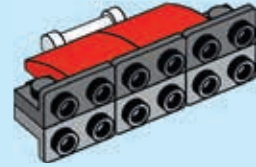

113

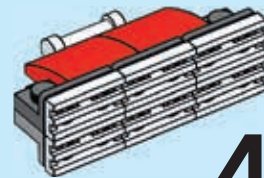

4x

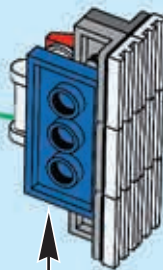
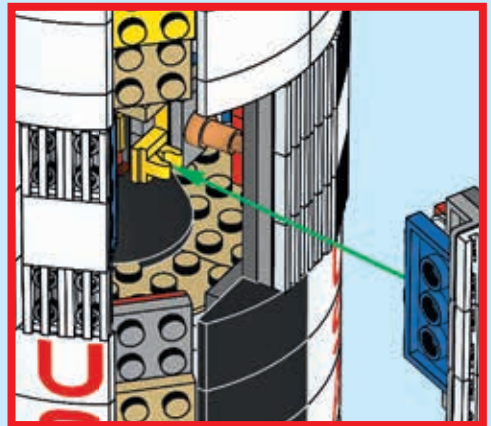
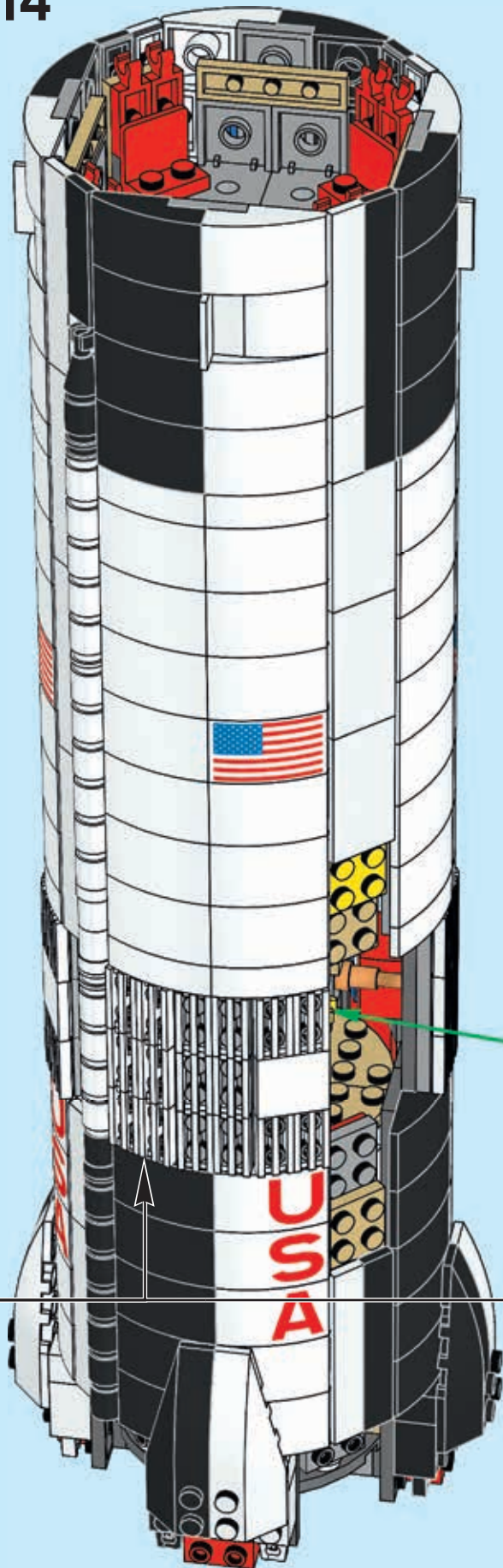

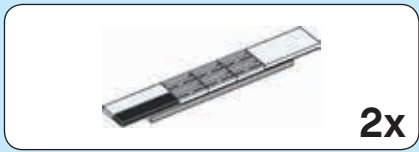

2x

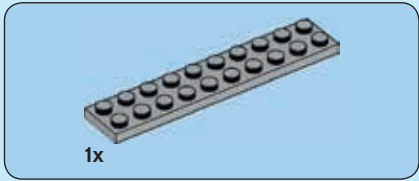

1x

115

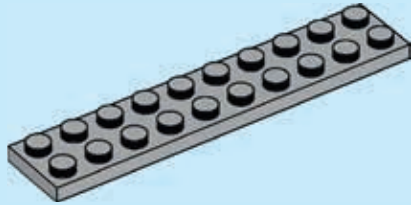

6x

116

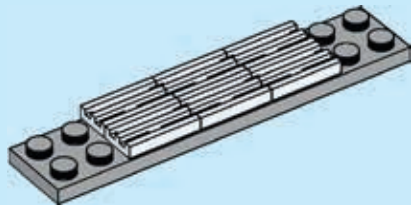

1x

1x

1x

117

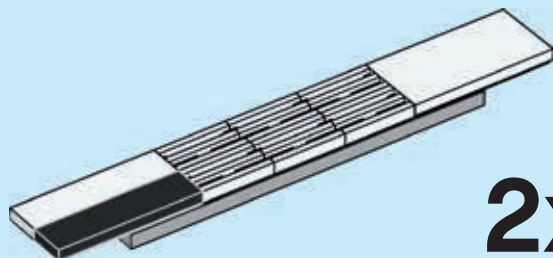

2x

118

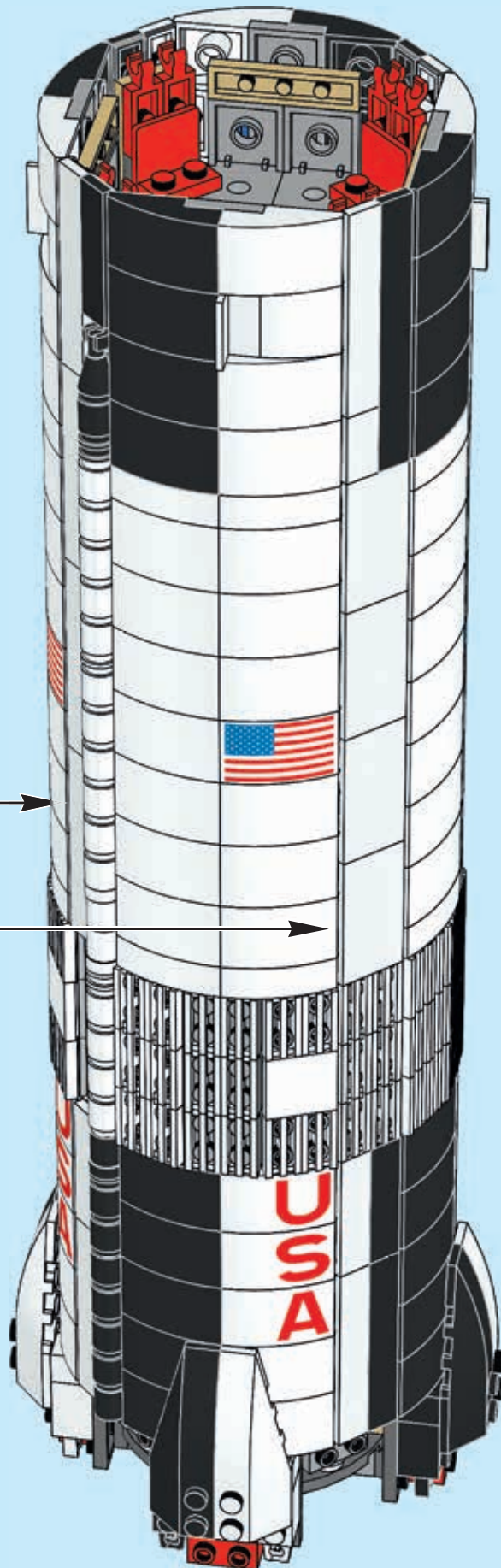

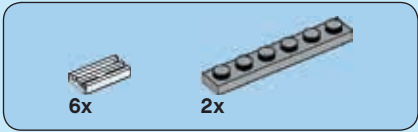

119

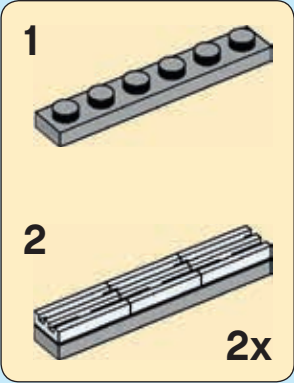
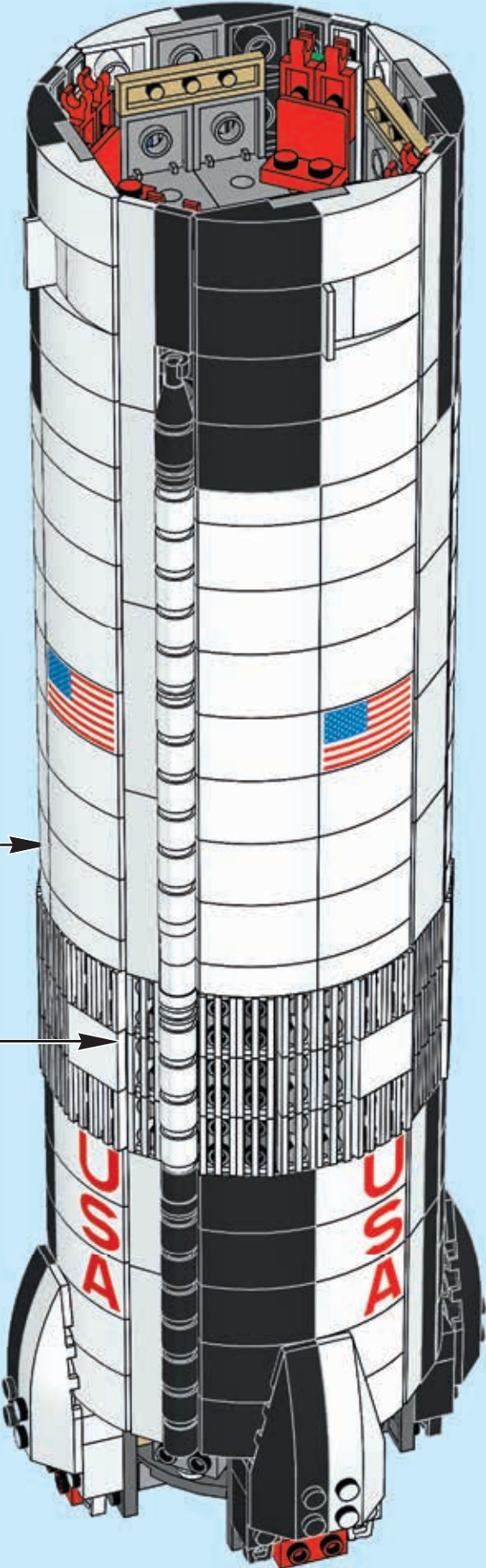

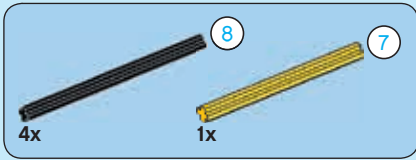
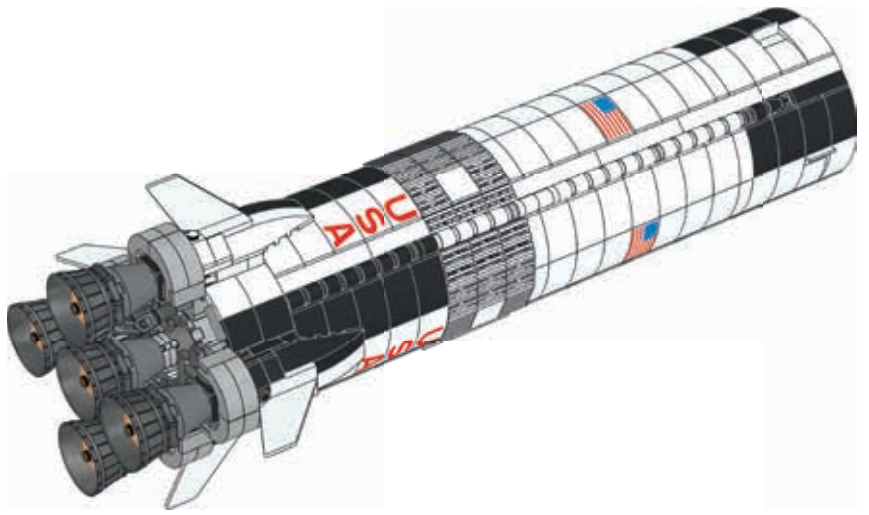

120

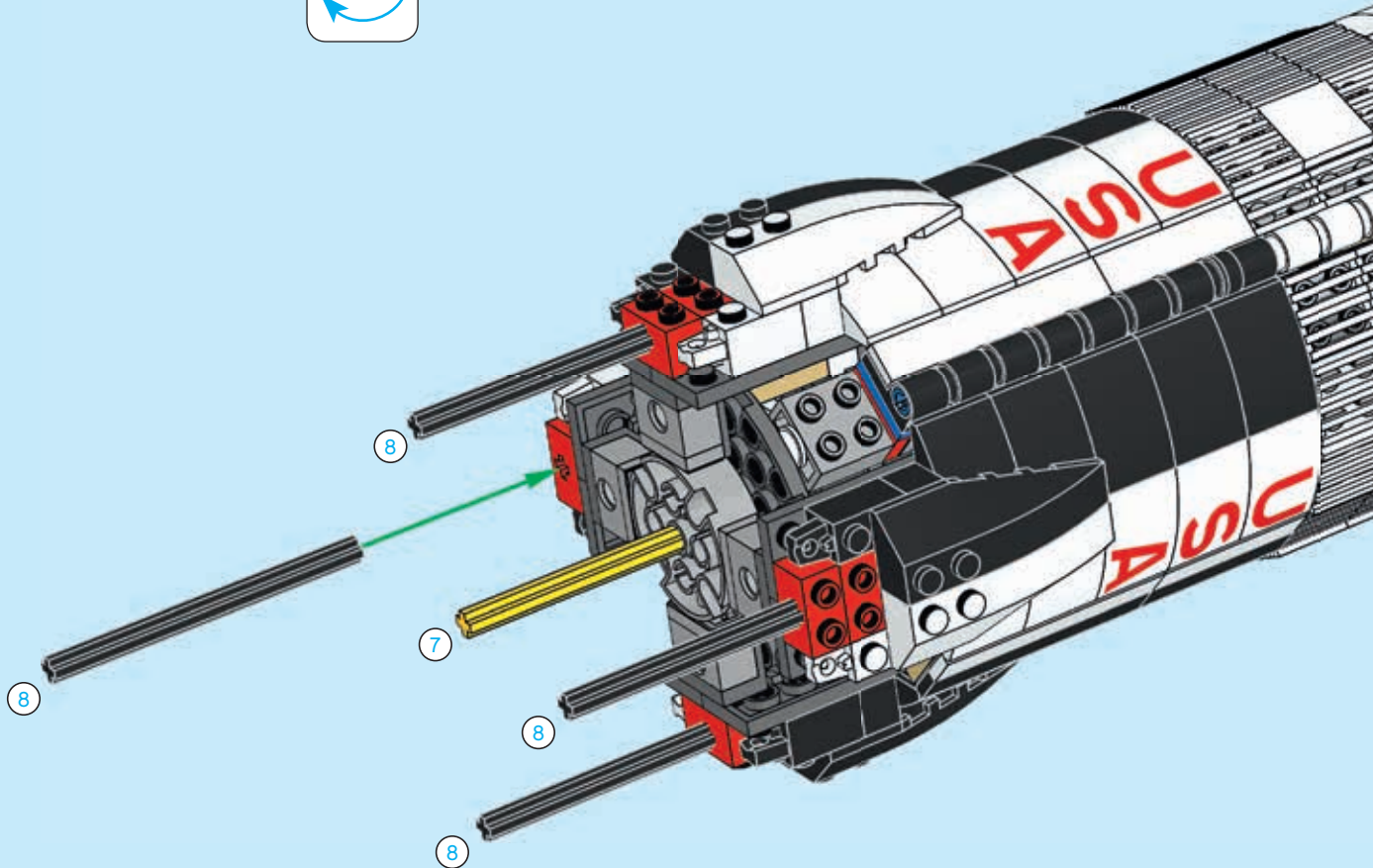



121

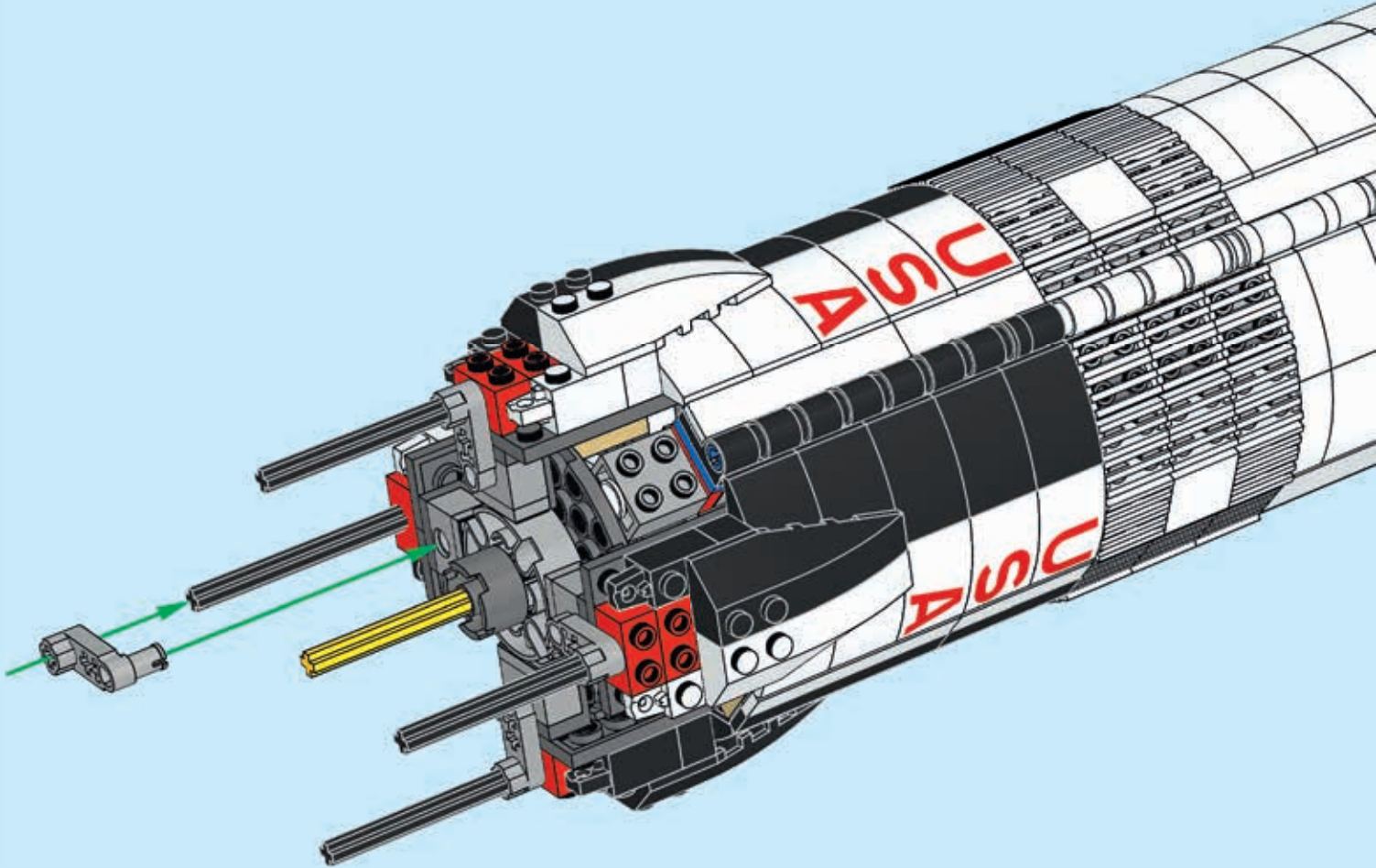



122

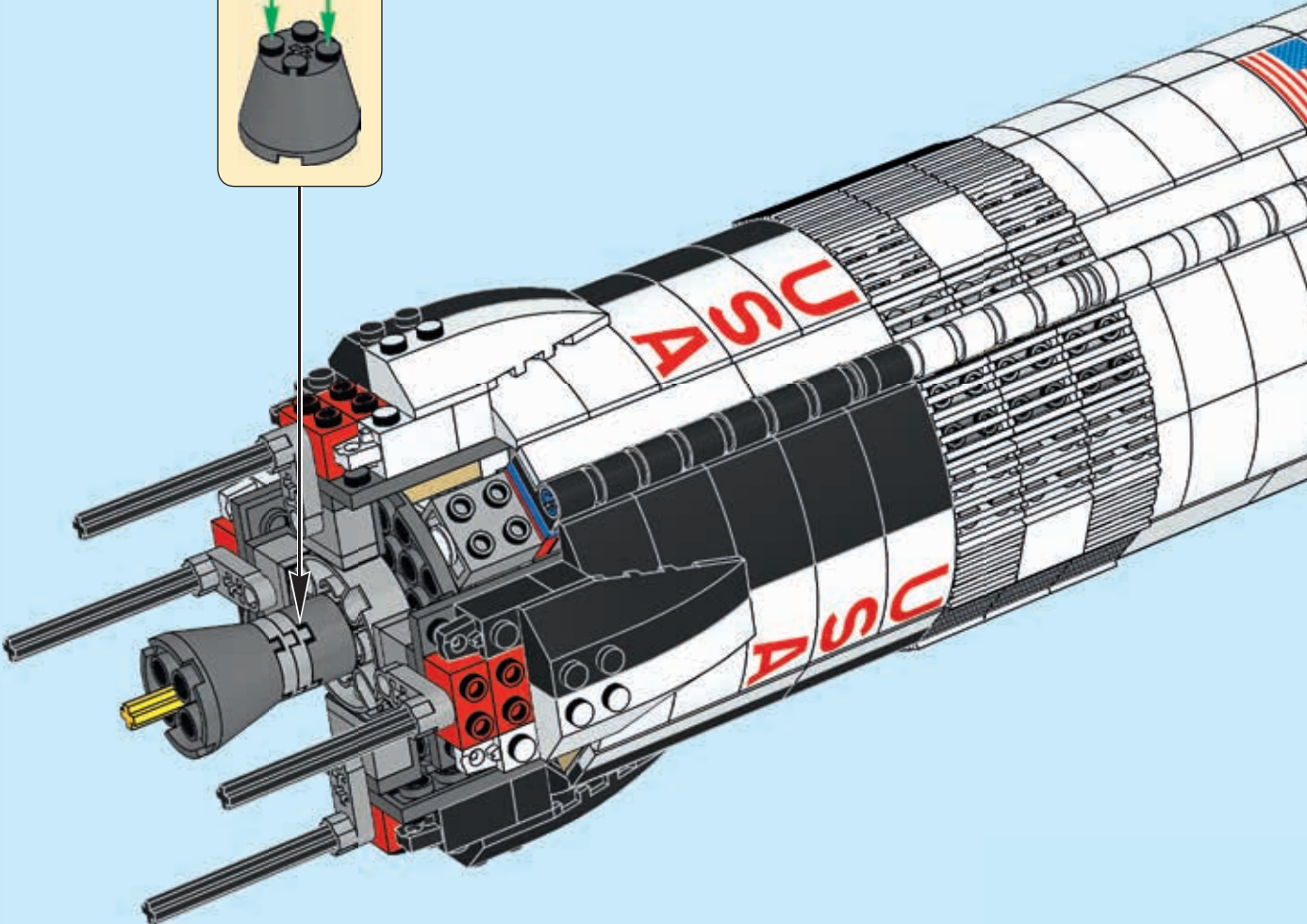
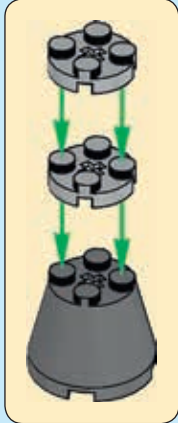



123

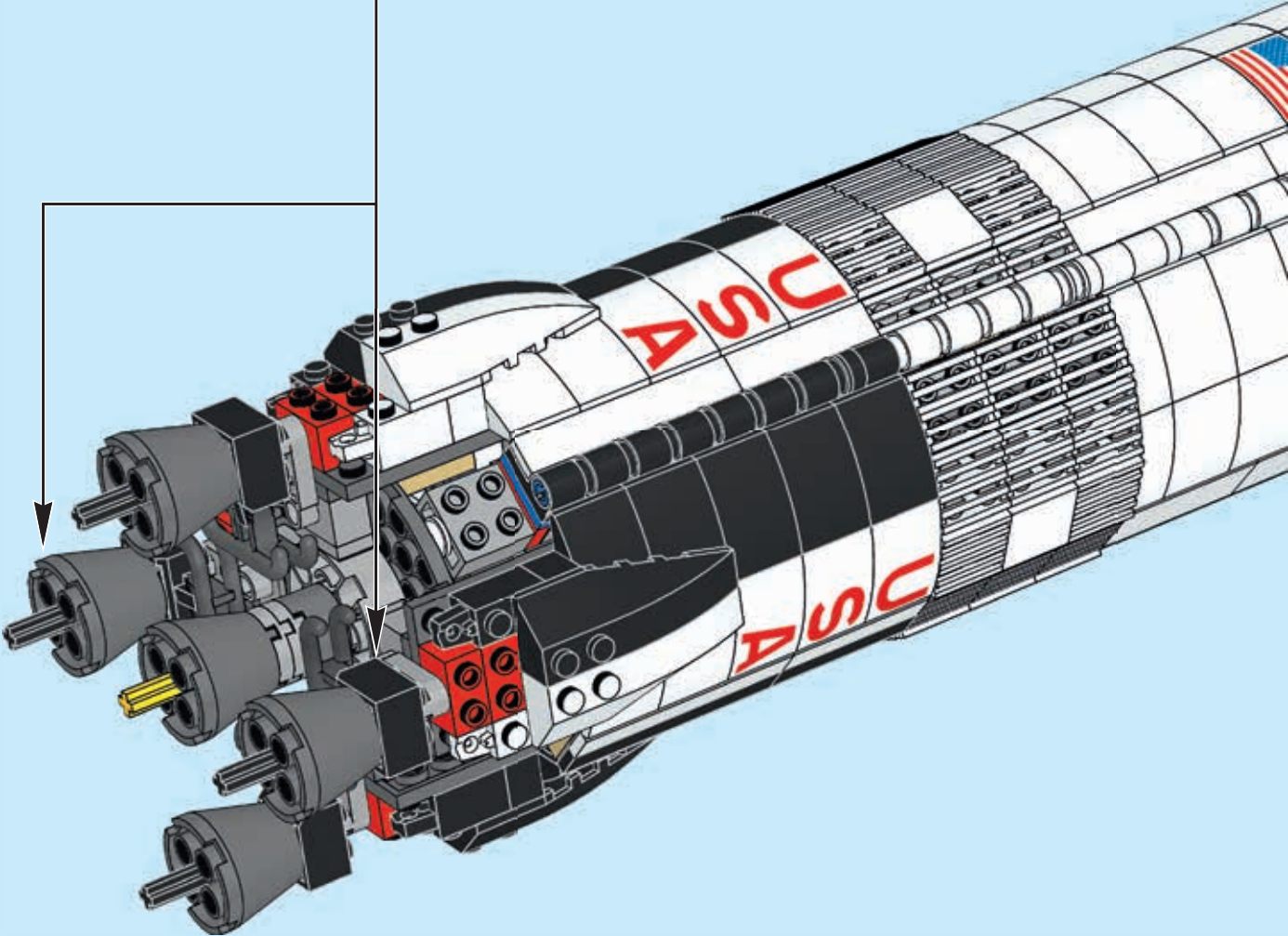
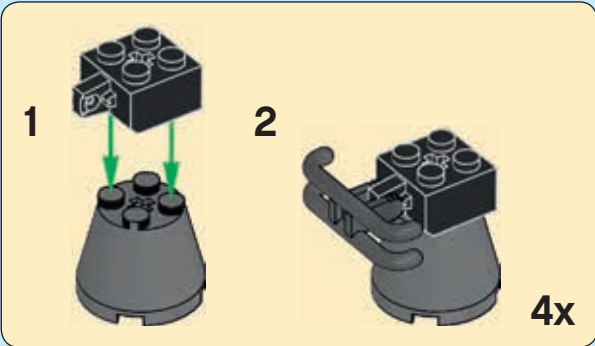



124

1

2

3

4

5x

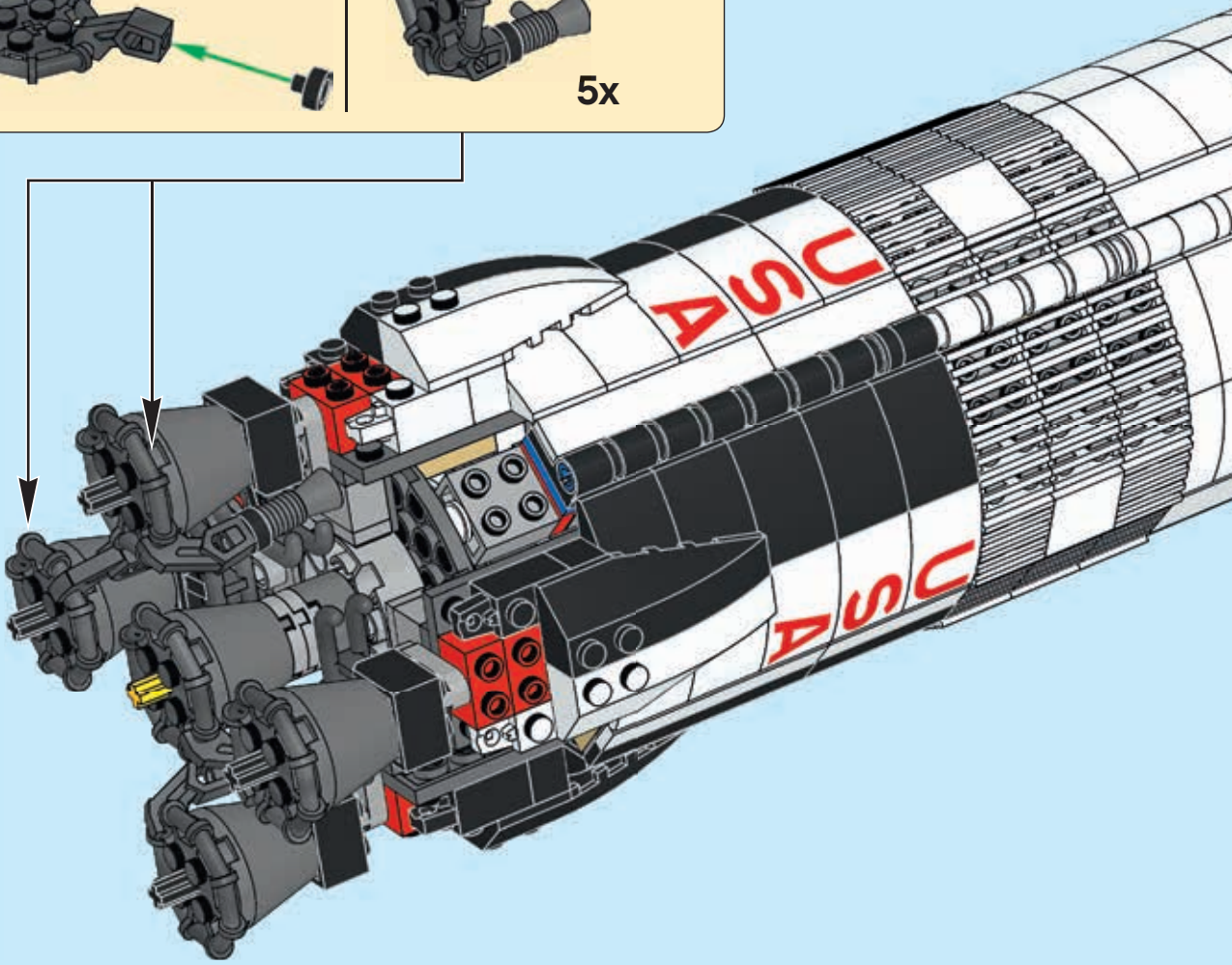



125

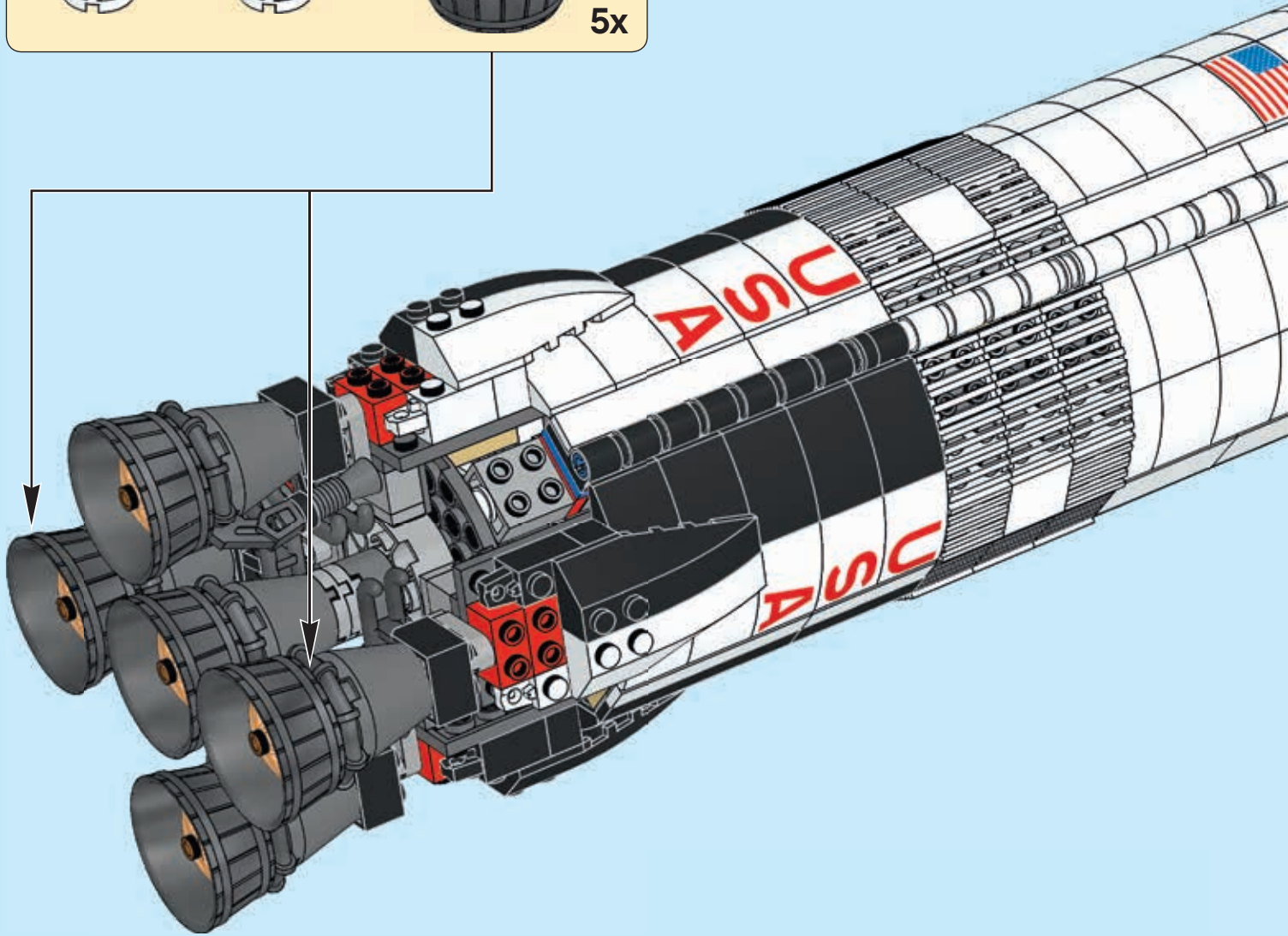
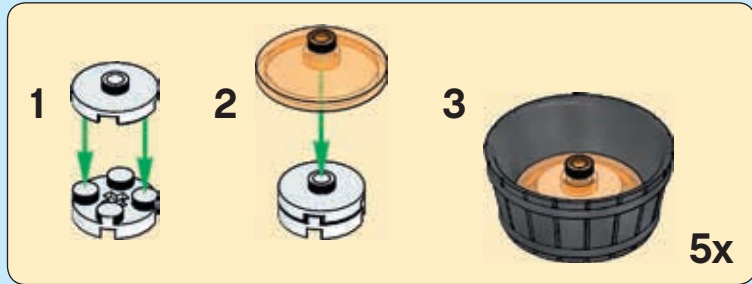

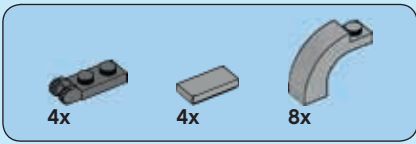

126

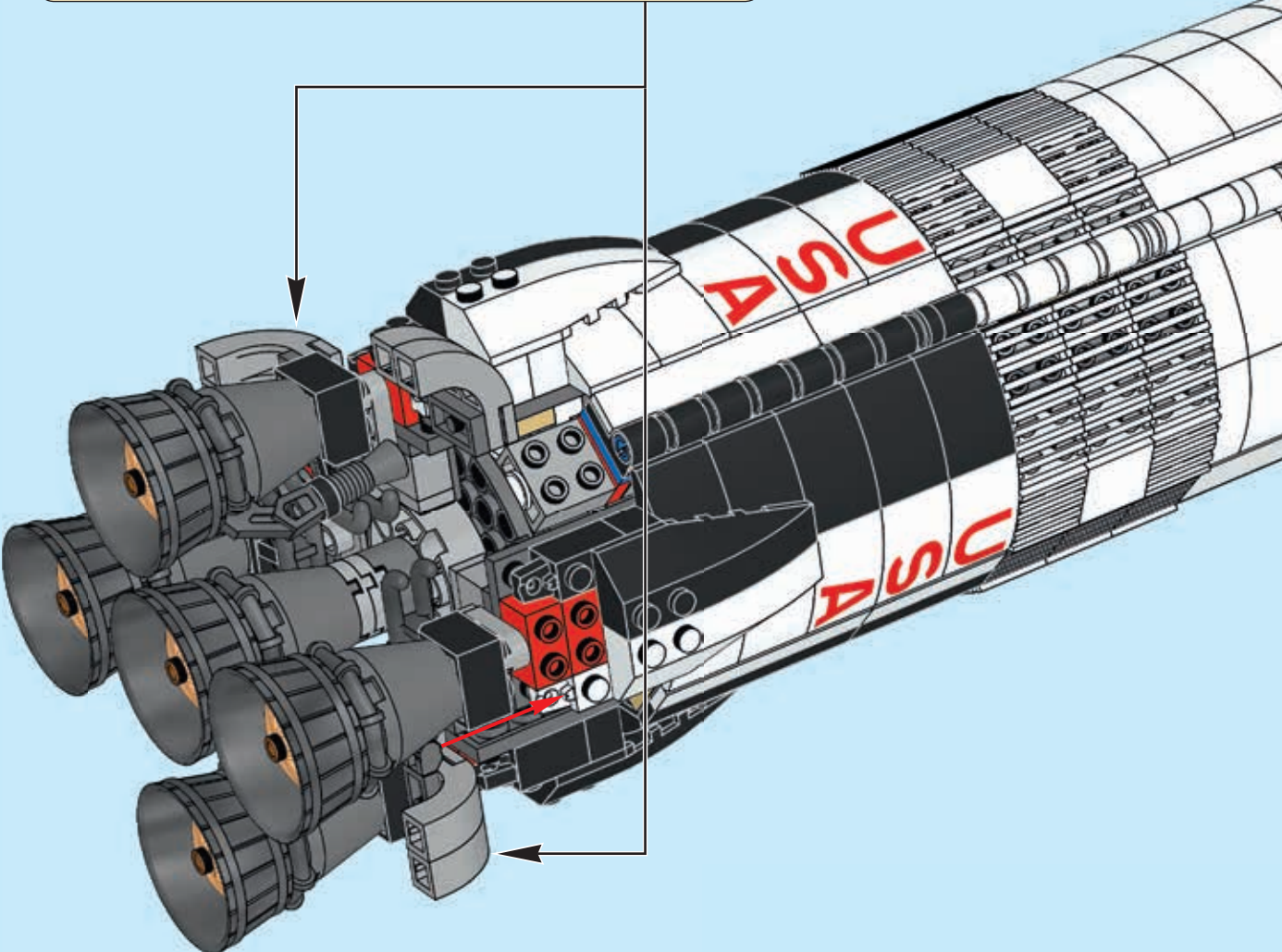
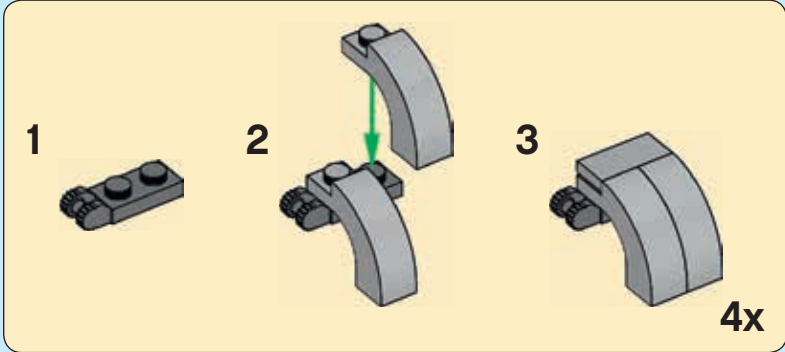

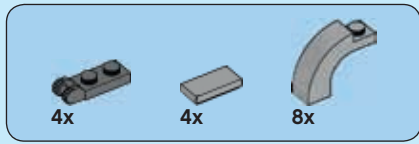

127

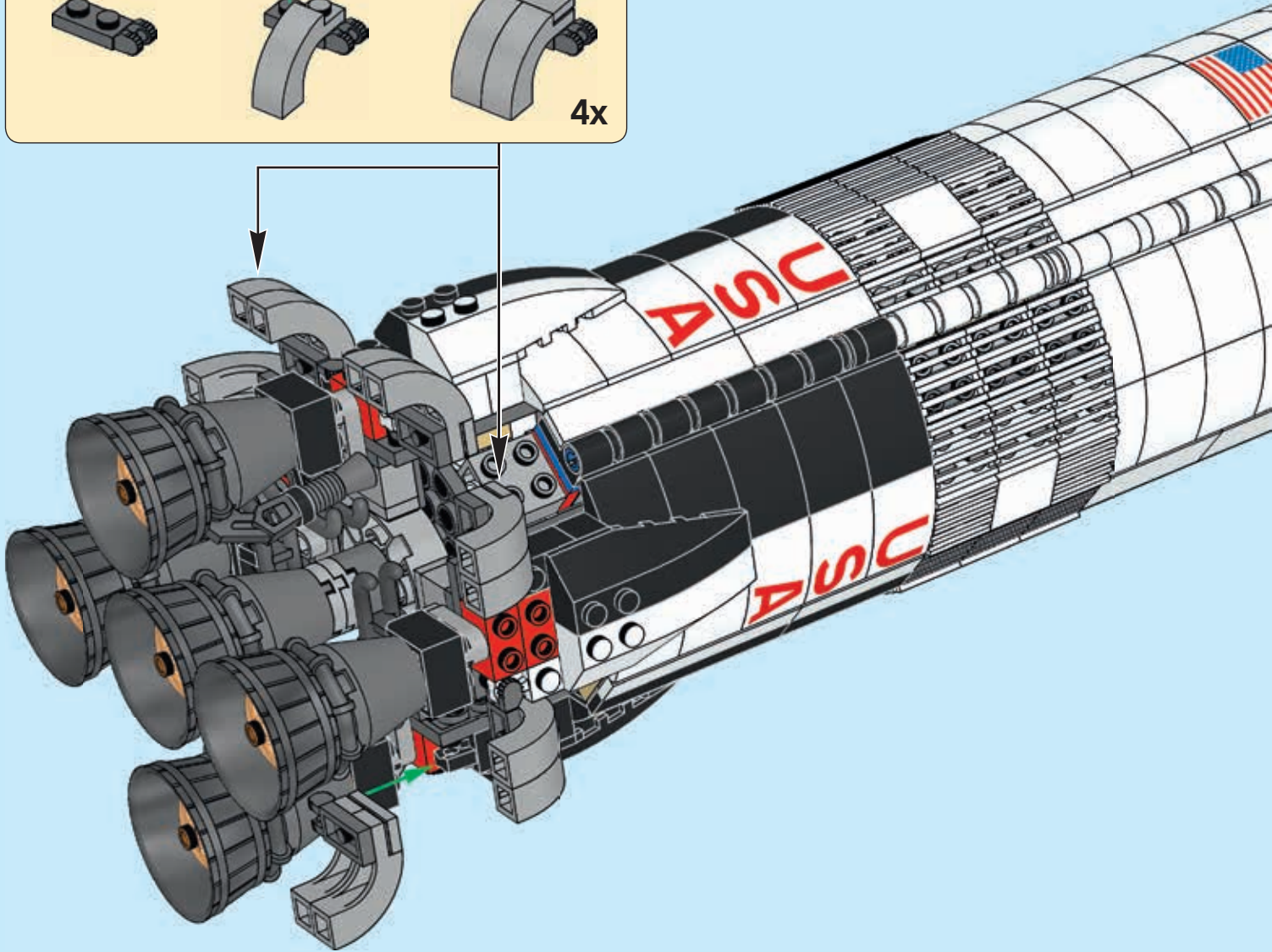
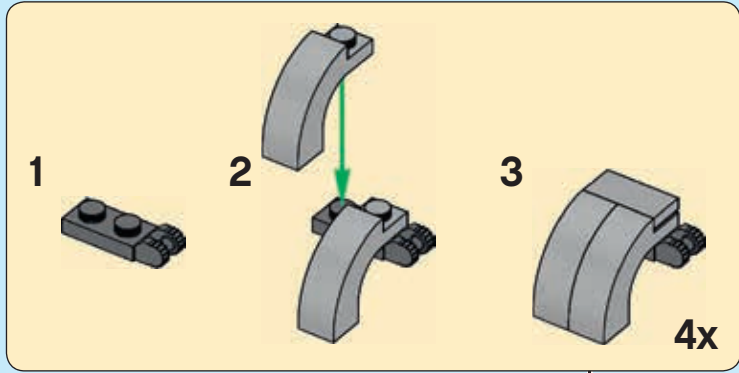

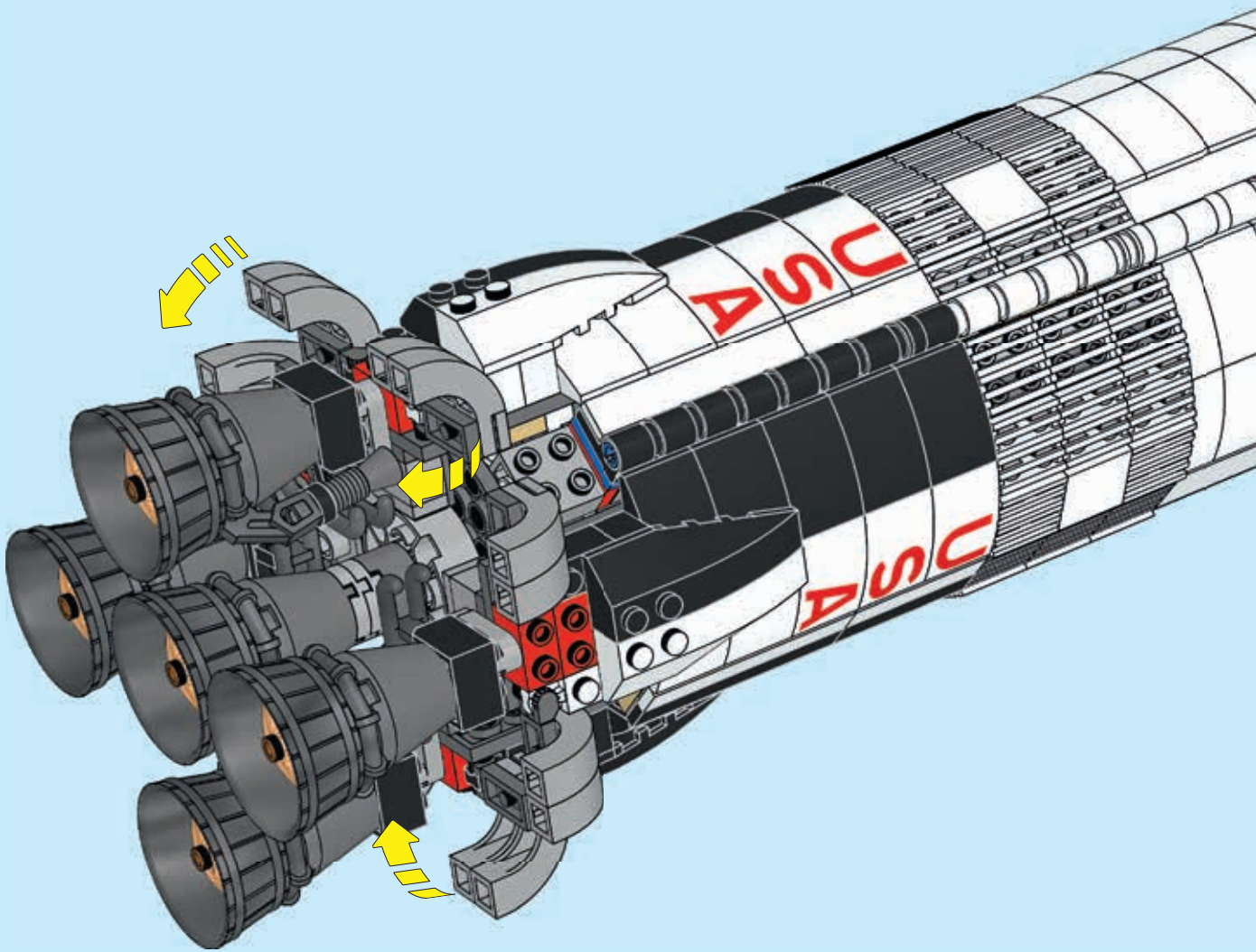



129



130



131



132



4x

133

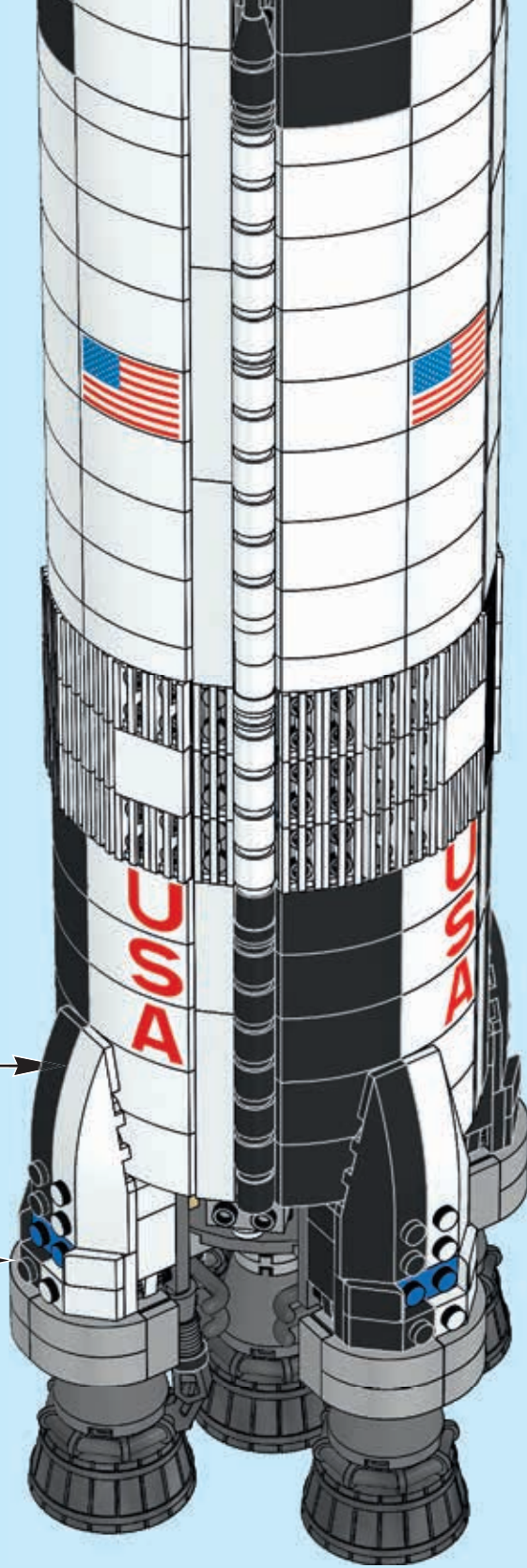

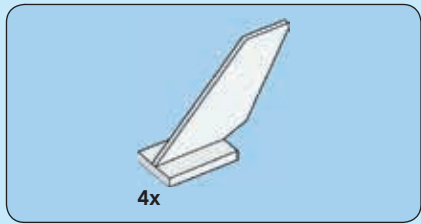

134

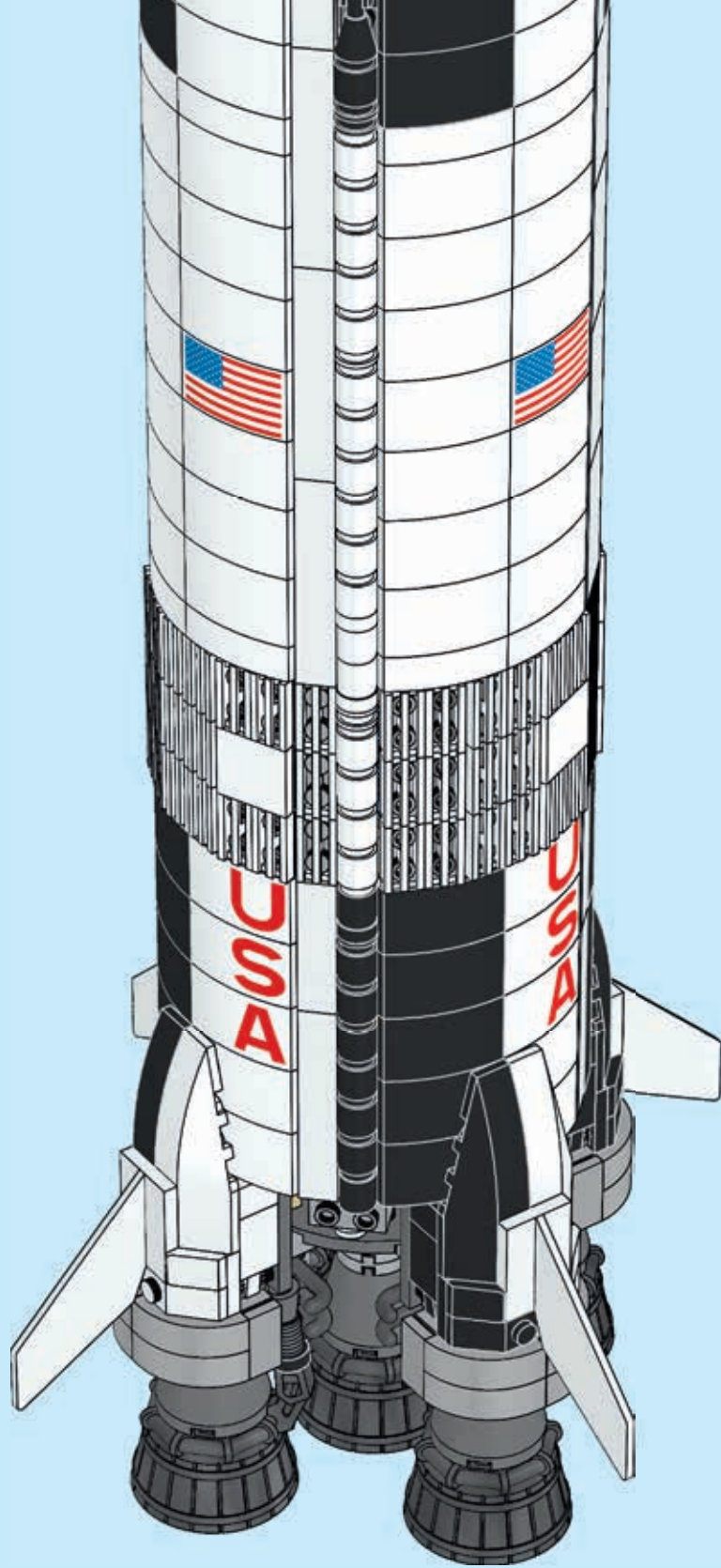

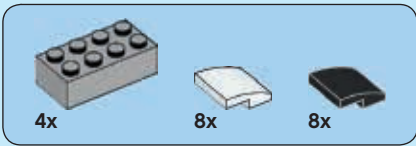

135

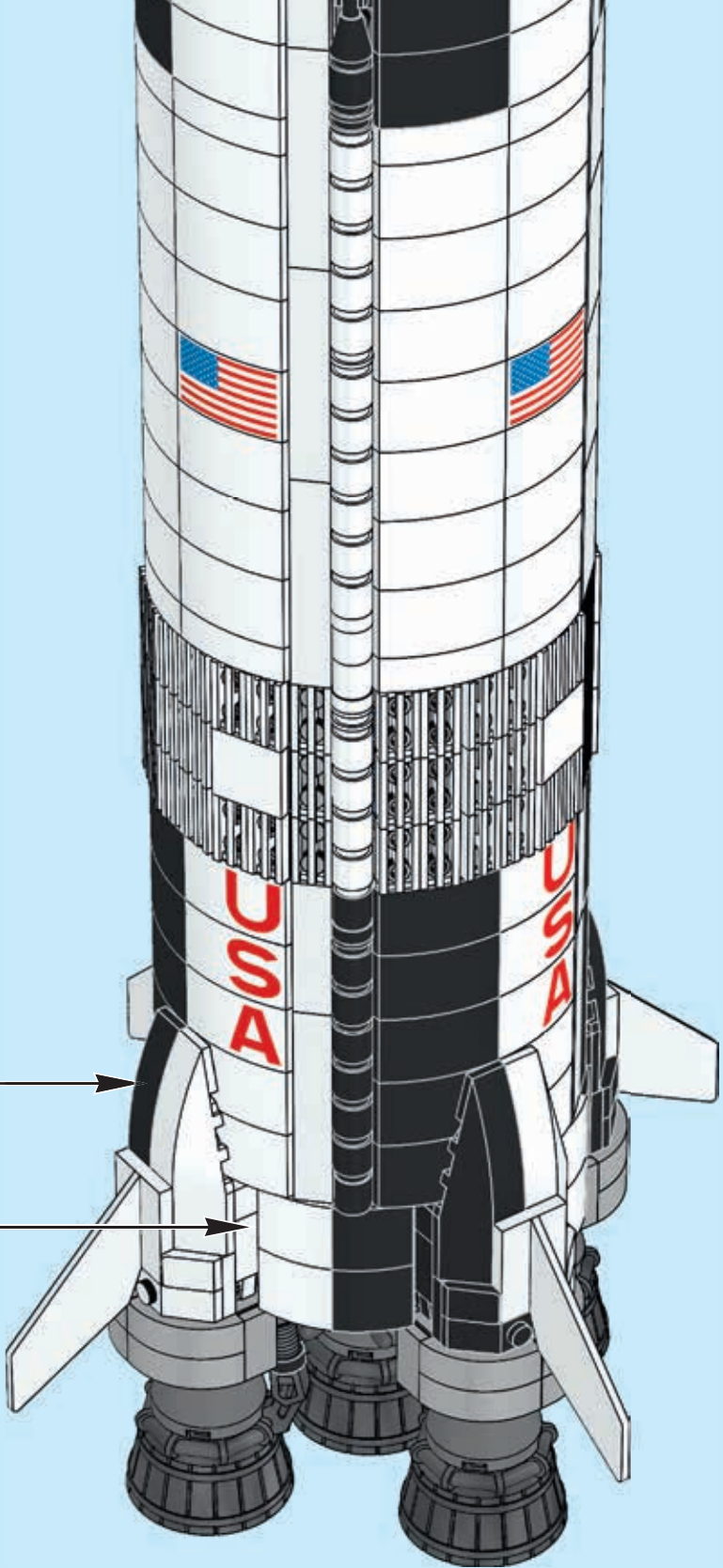
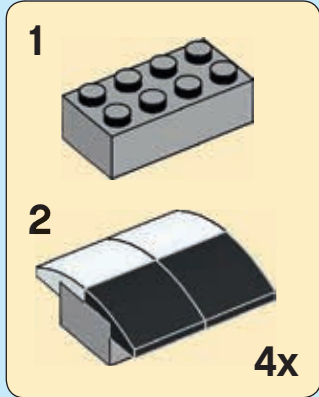

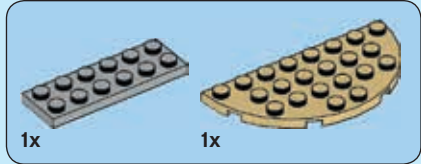
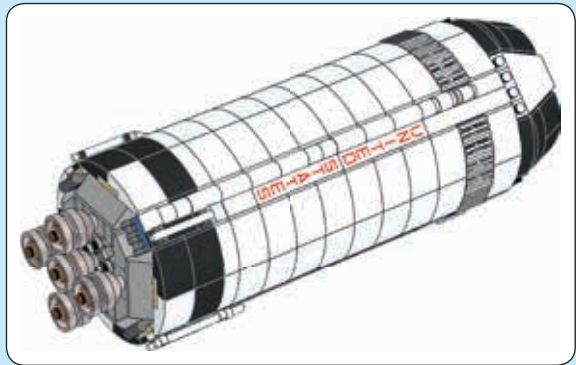
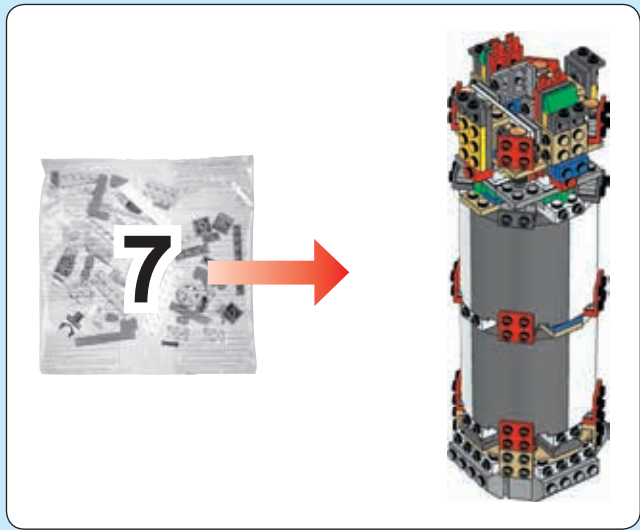

136

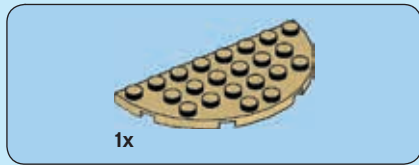
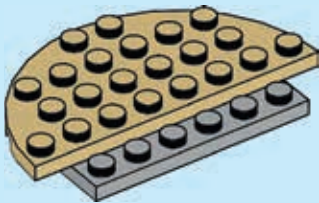

137

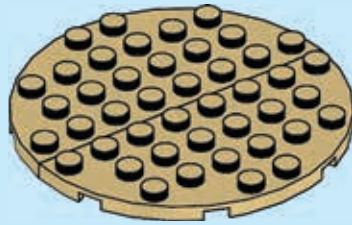

138

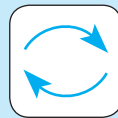



8x

139

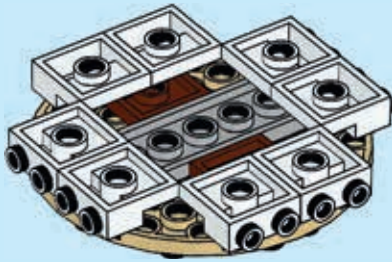

4x



4x

140

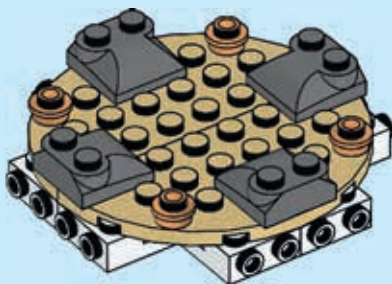
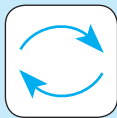

4x

141

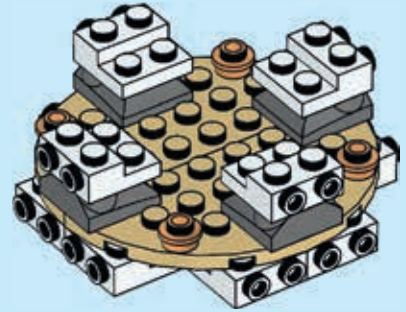

4x



4x



4x

142

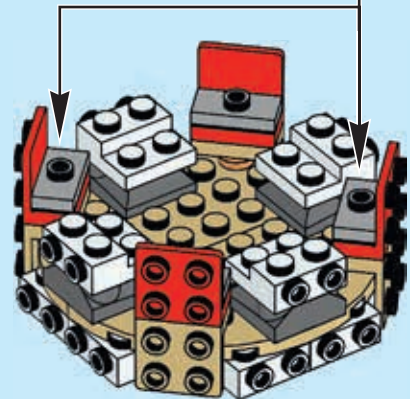
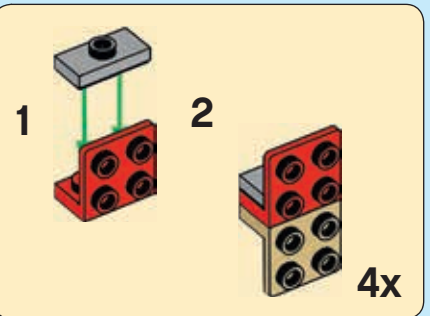



143

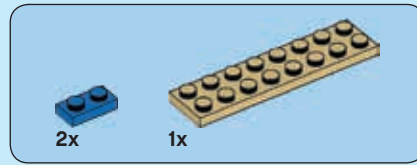
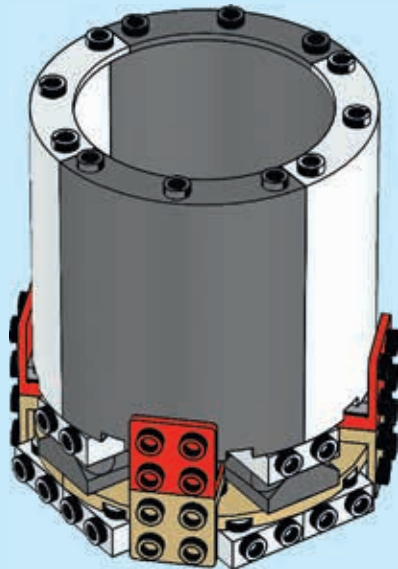

144

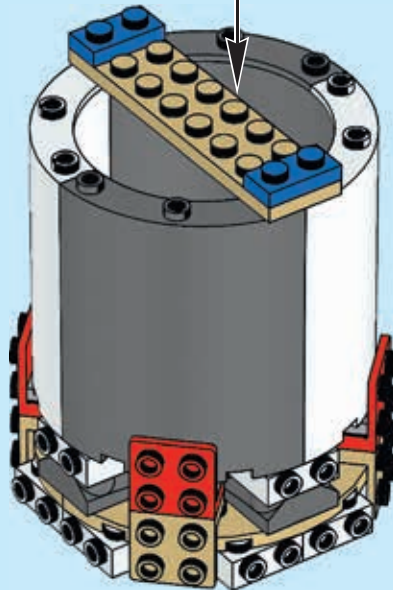
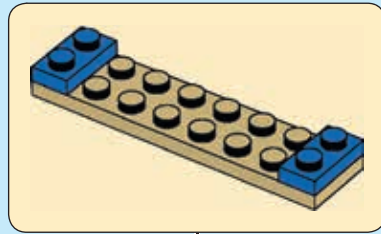



145

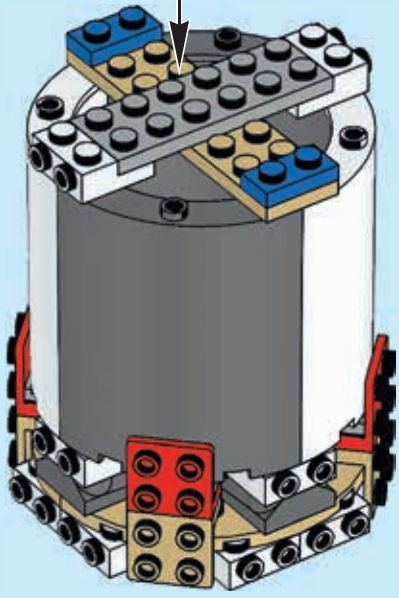
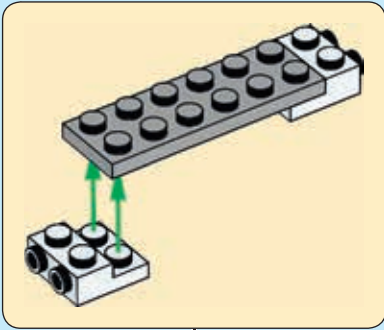

146

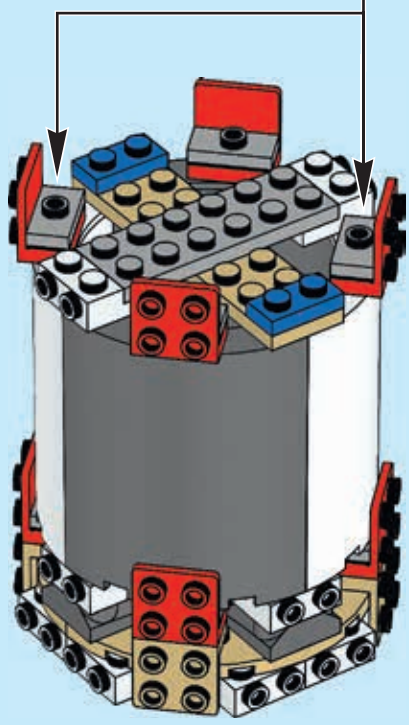
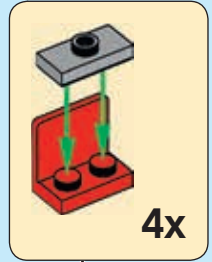



147

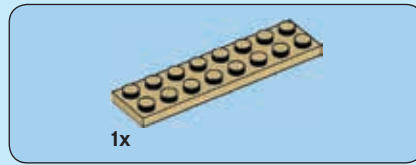
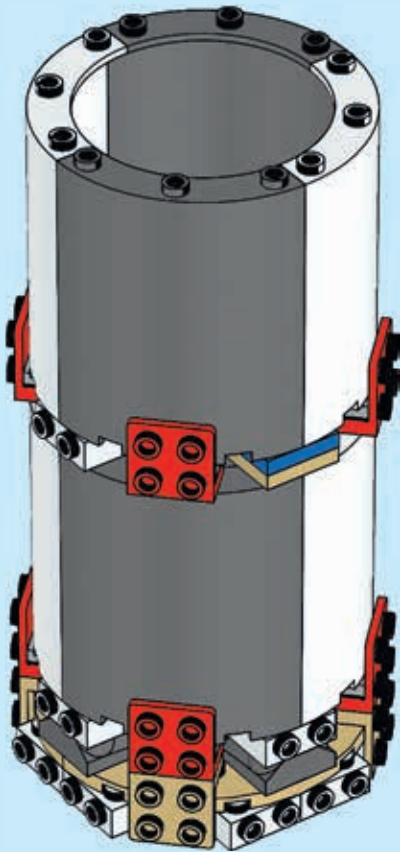

148

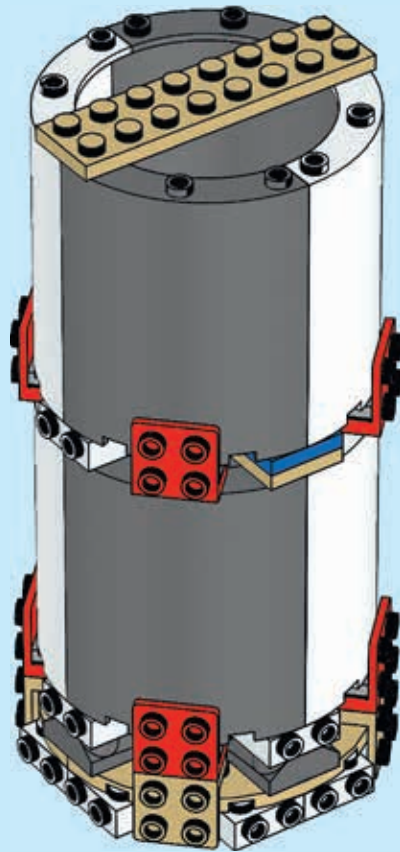

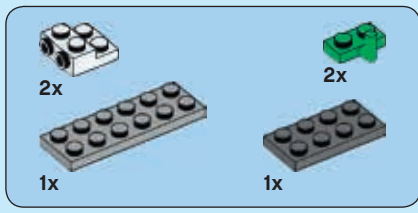

149

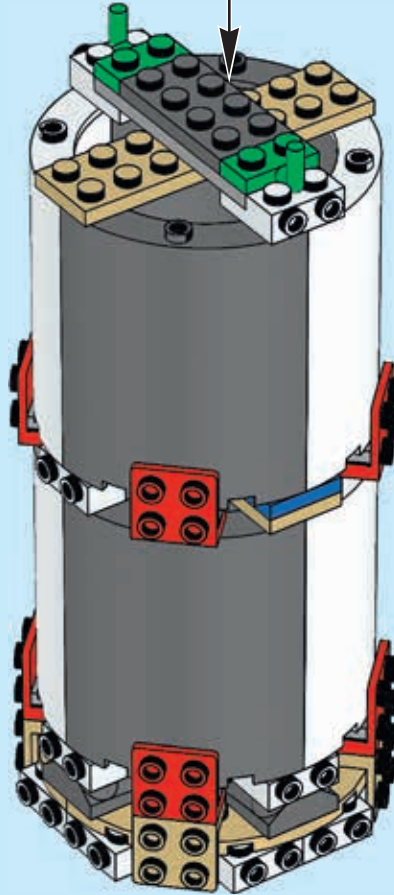
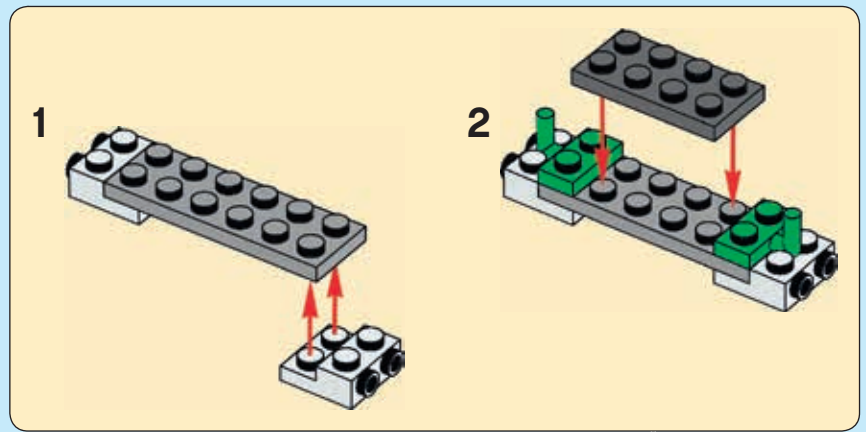

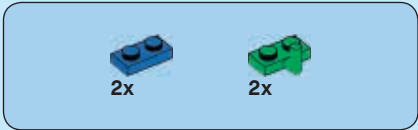

150

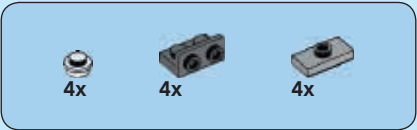
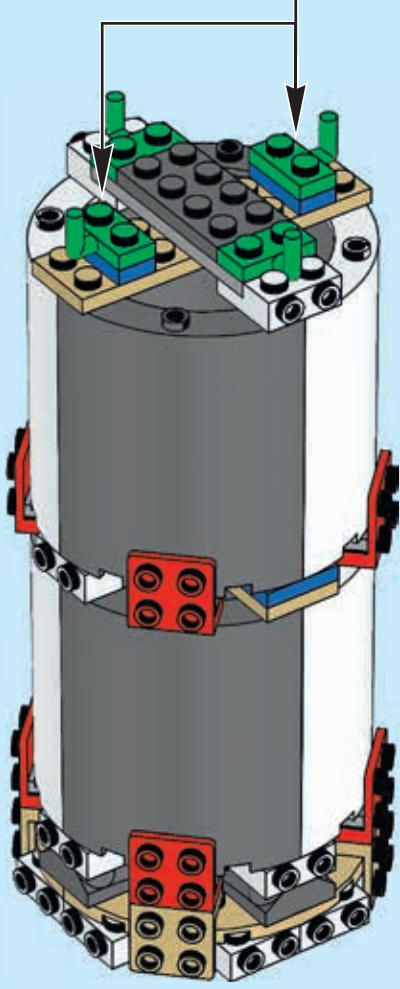
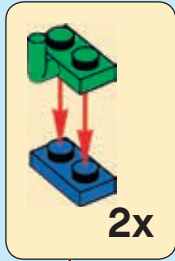

151

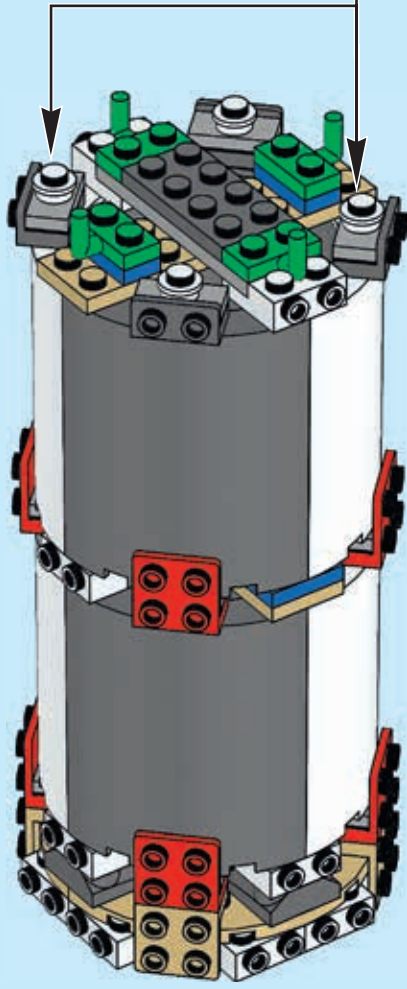
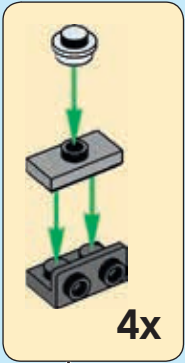



152

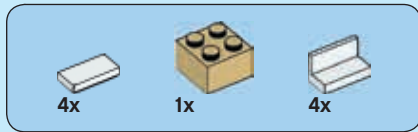
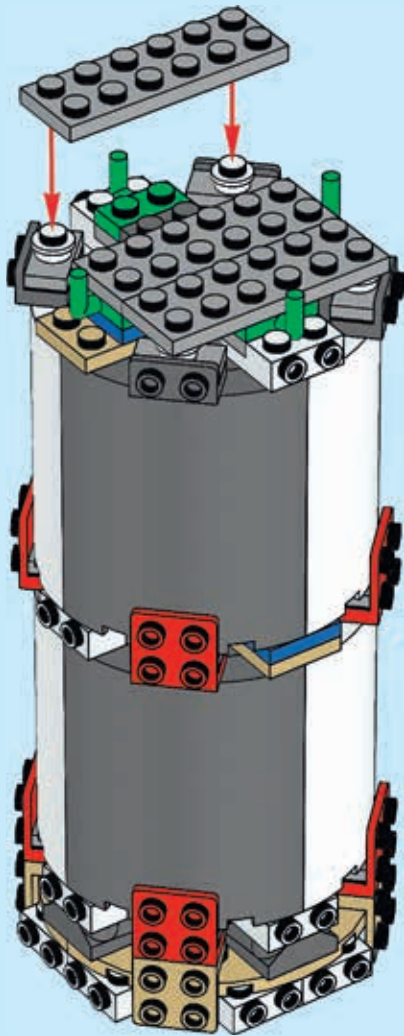

153

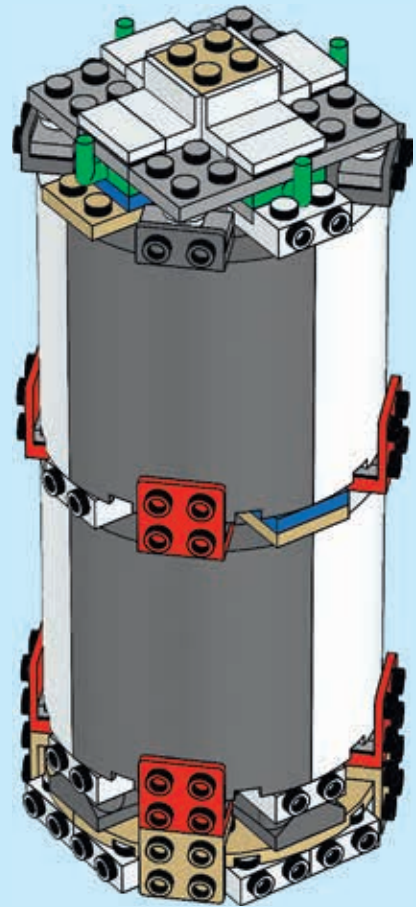



1x

154

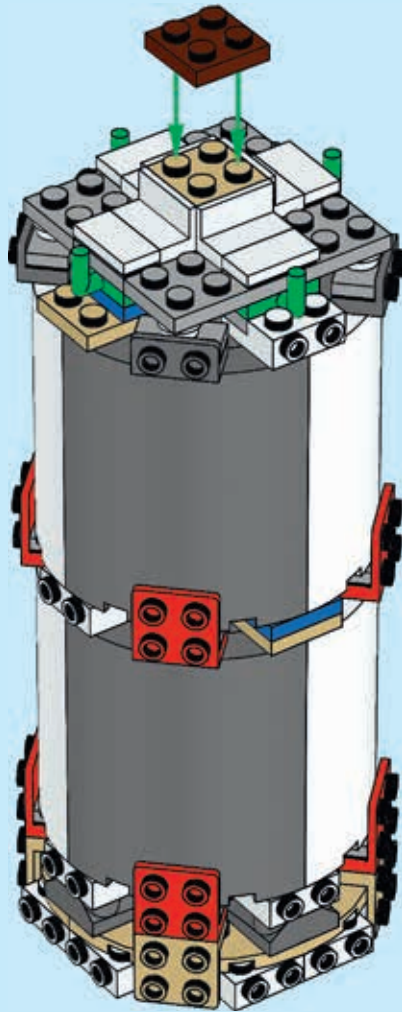



155

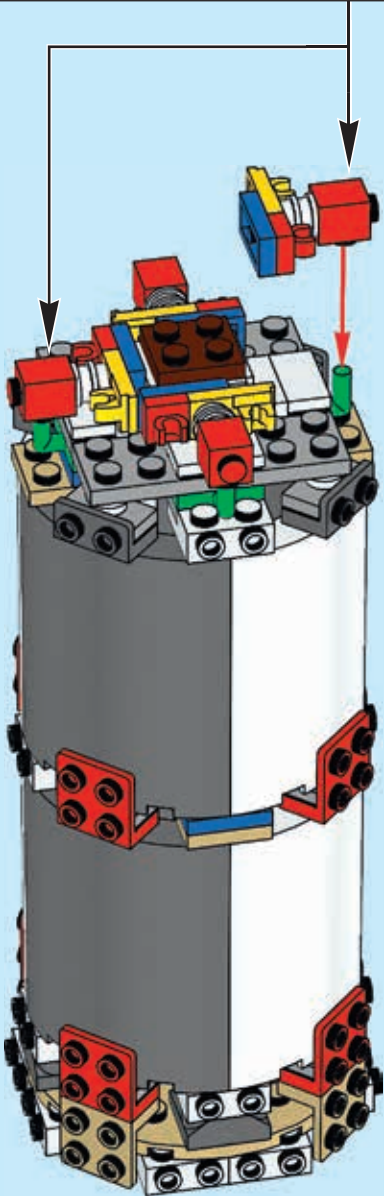
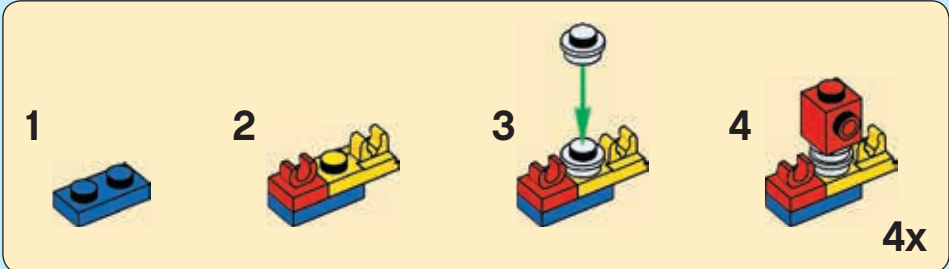



4x



4x

156

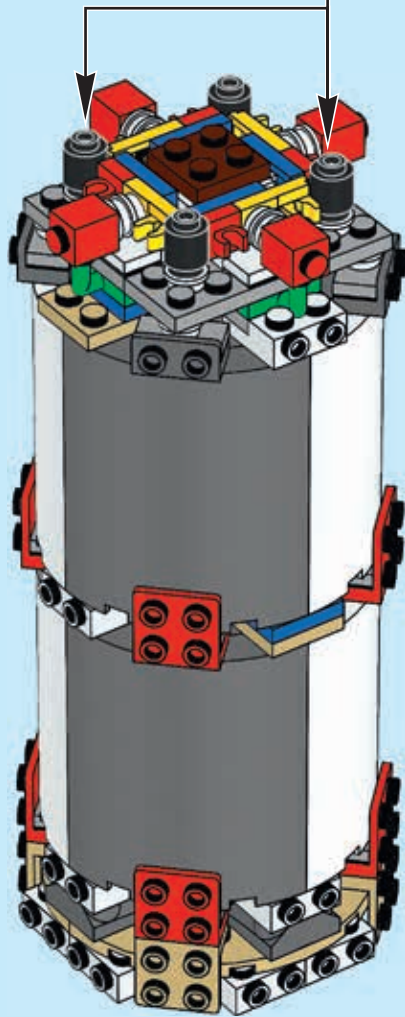

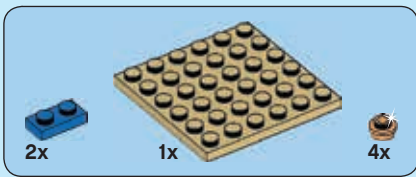

157

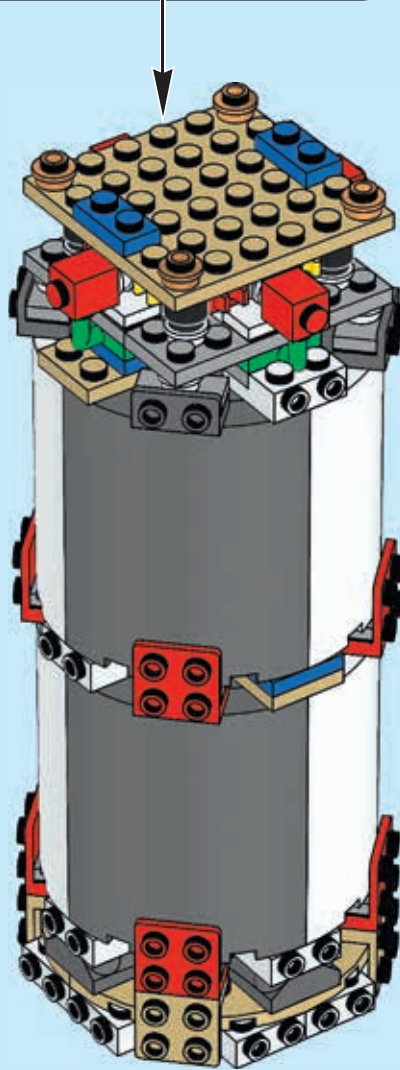
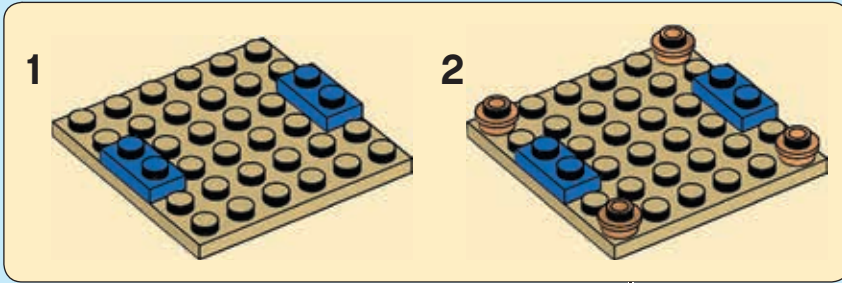



2x



1x

158



2x

159



1x

160

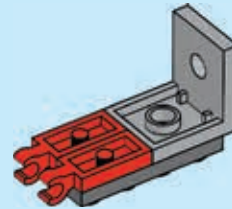

1x



2x

161

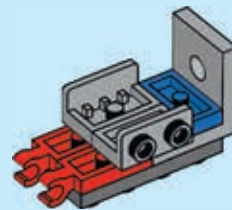



162

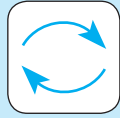

163

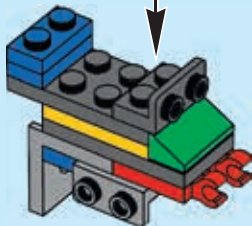
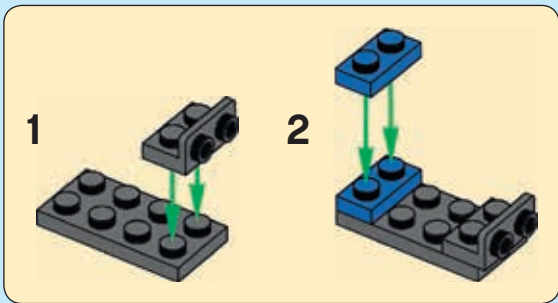

164

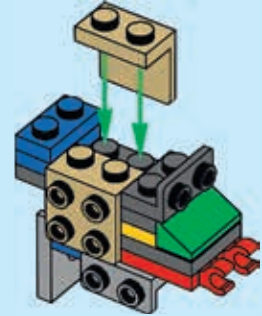

165

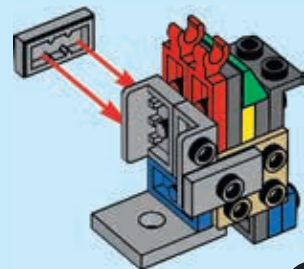
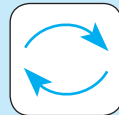

2x

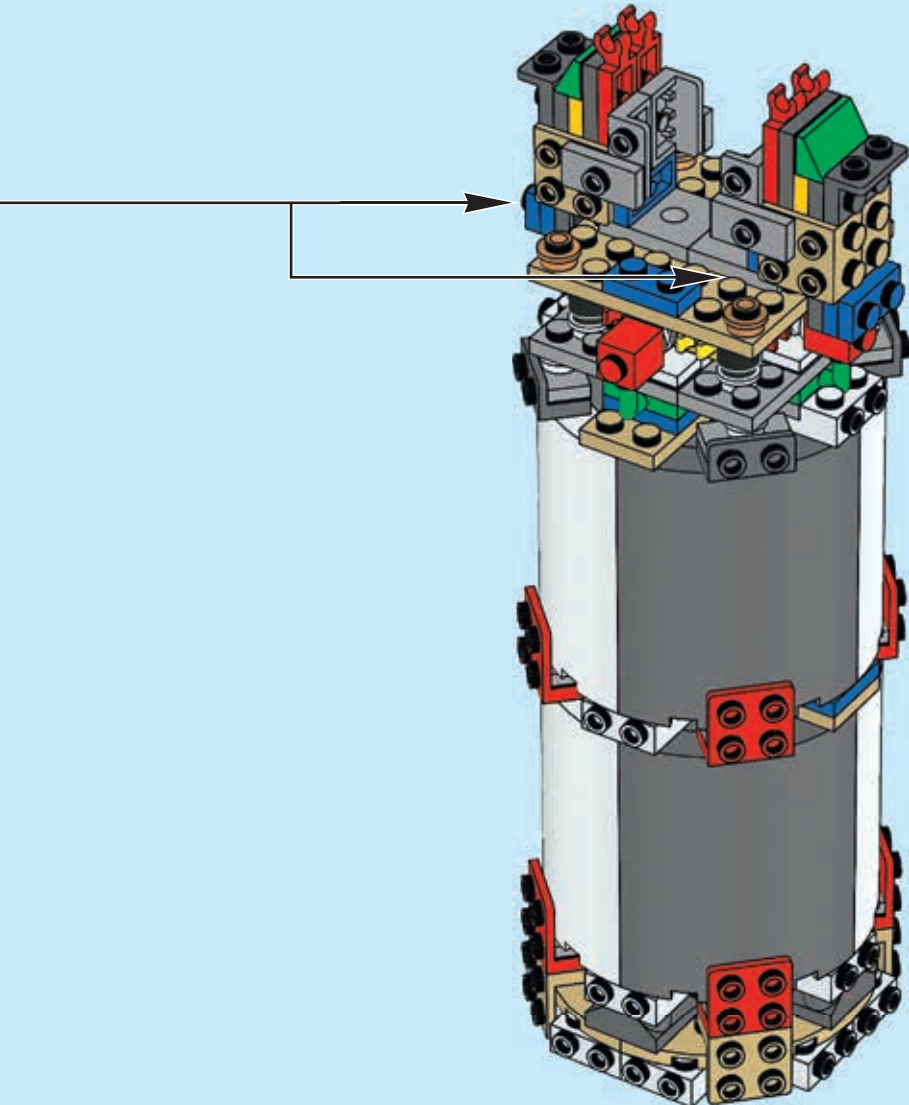

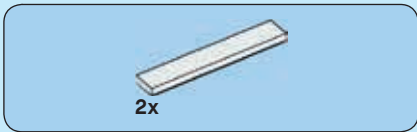

167

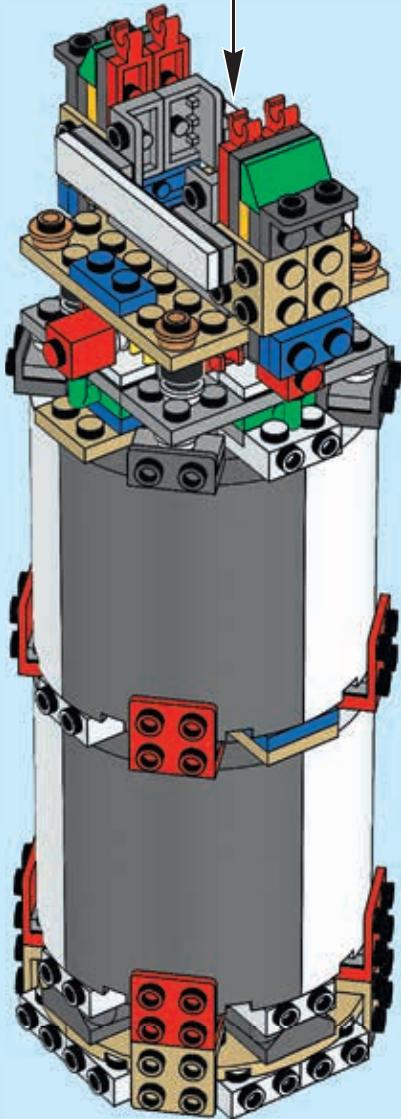
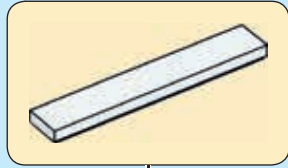

168

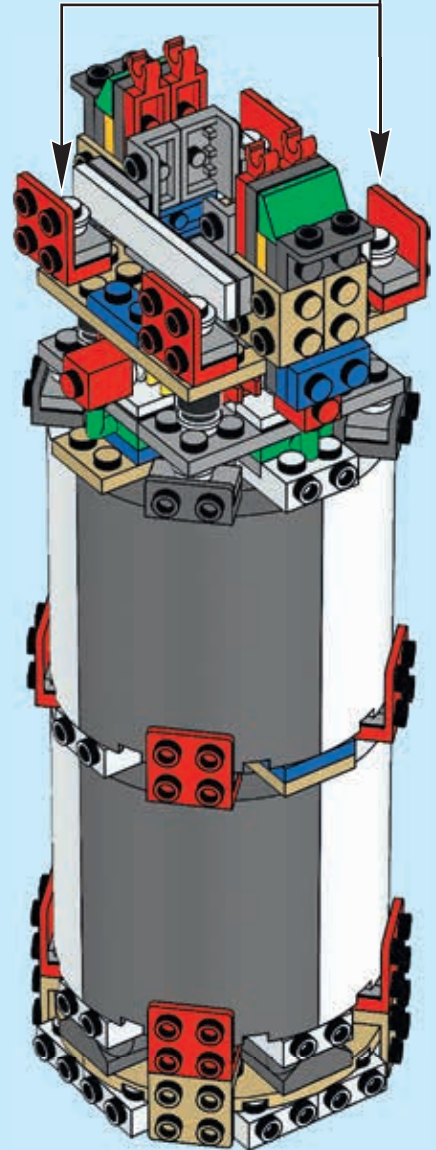
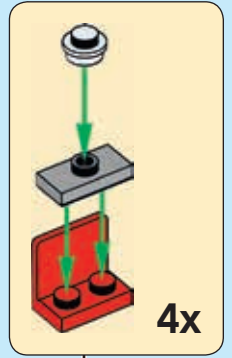



169

1



2



3



4

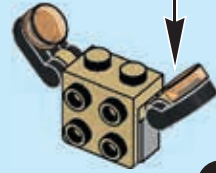

2x

170

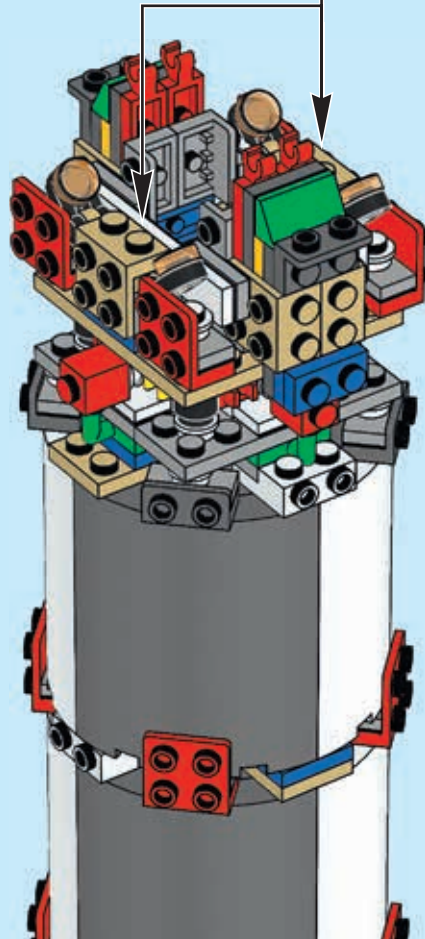

171

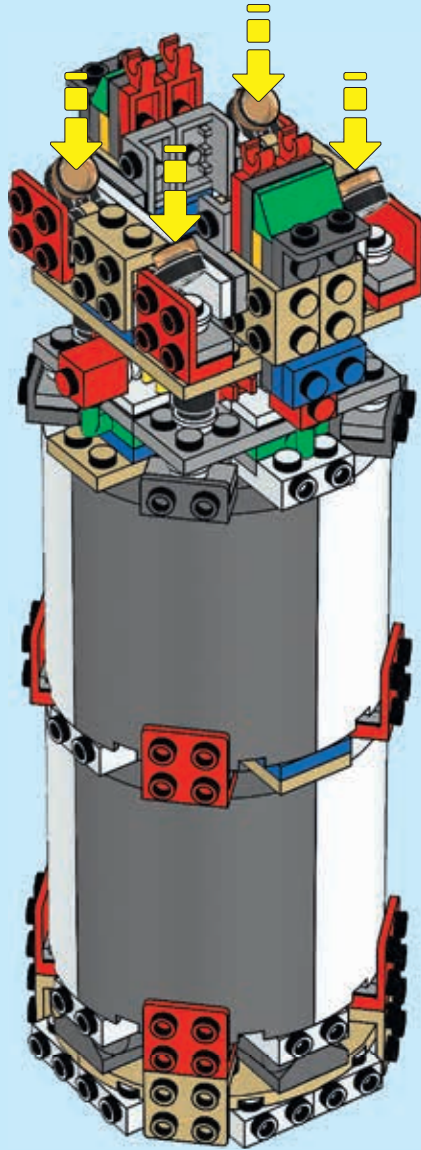



172

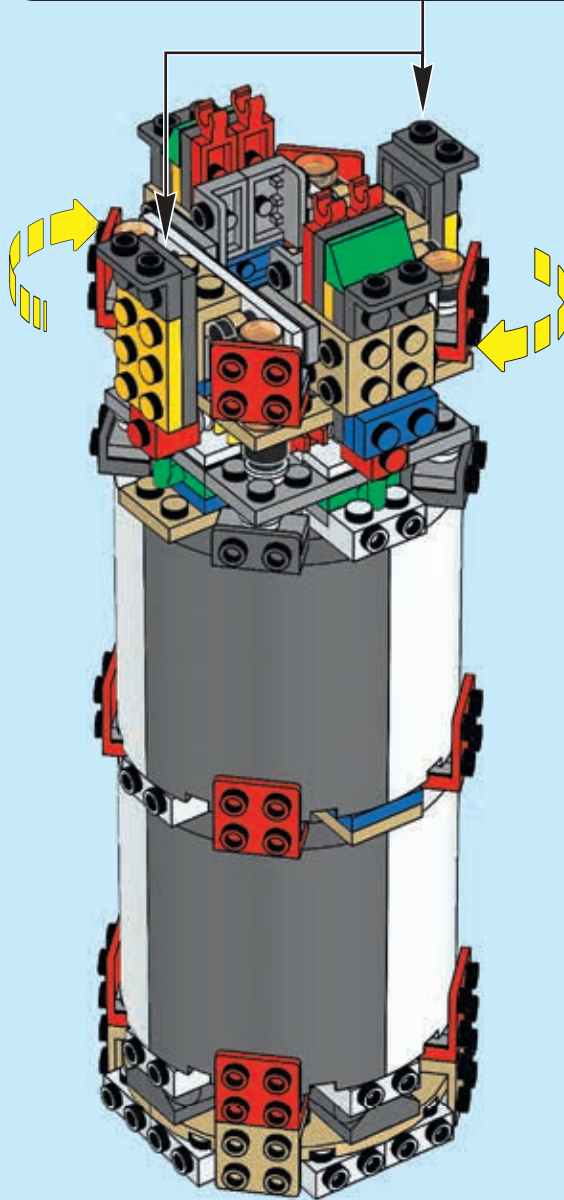

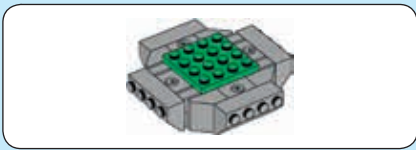

173

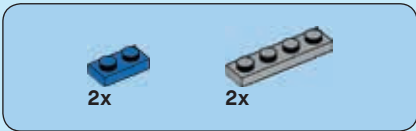

174



175

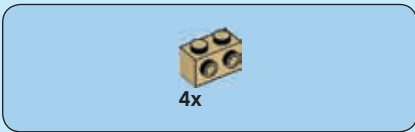

176



177

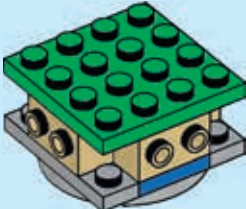

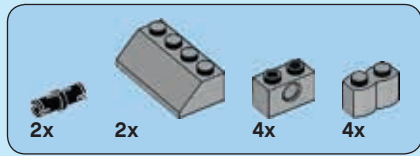

178

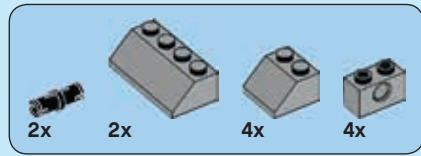
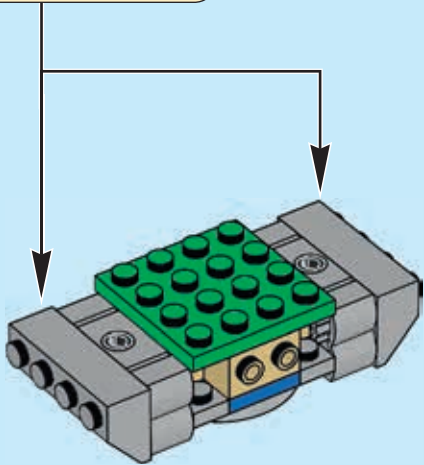
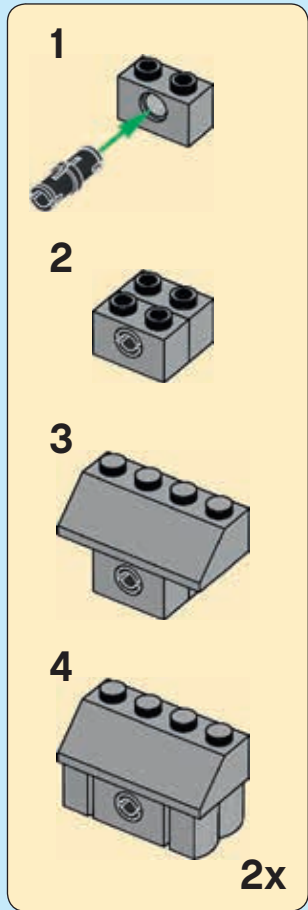

179

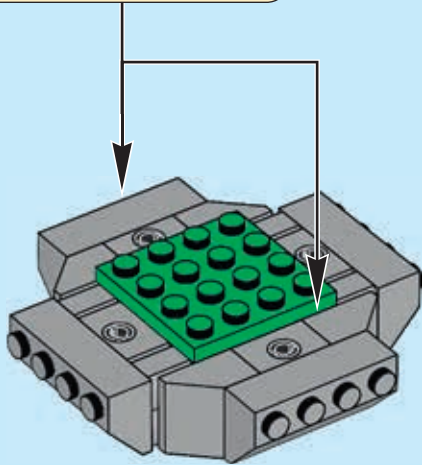
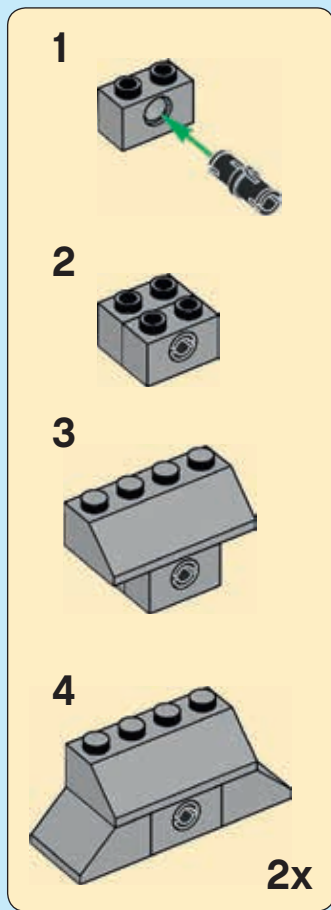

180

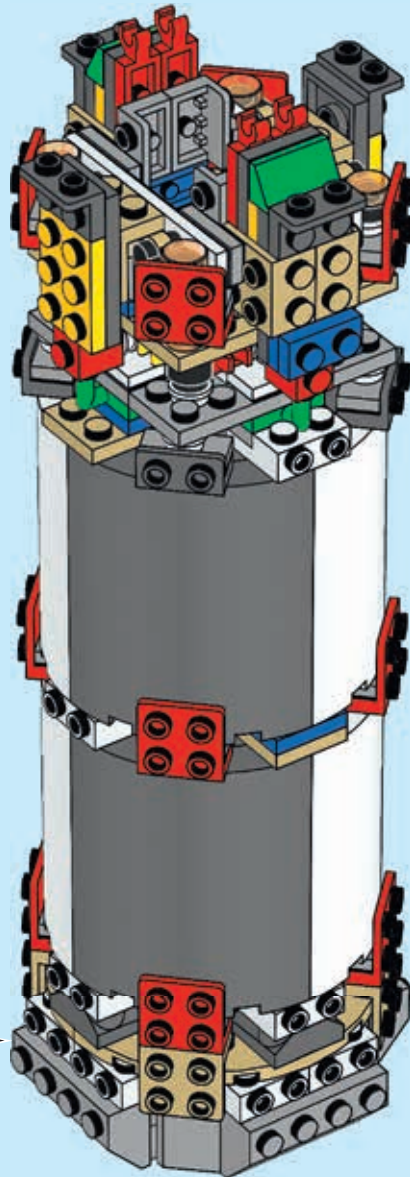

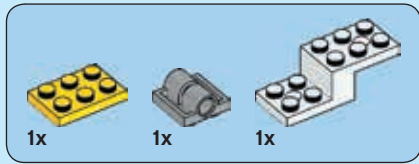
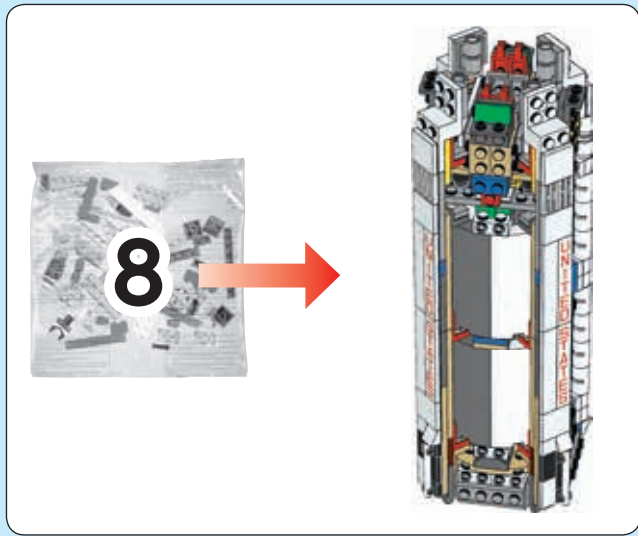

181

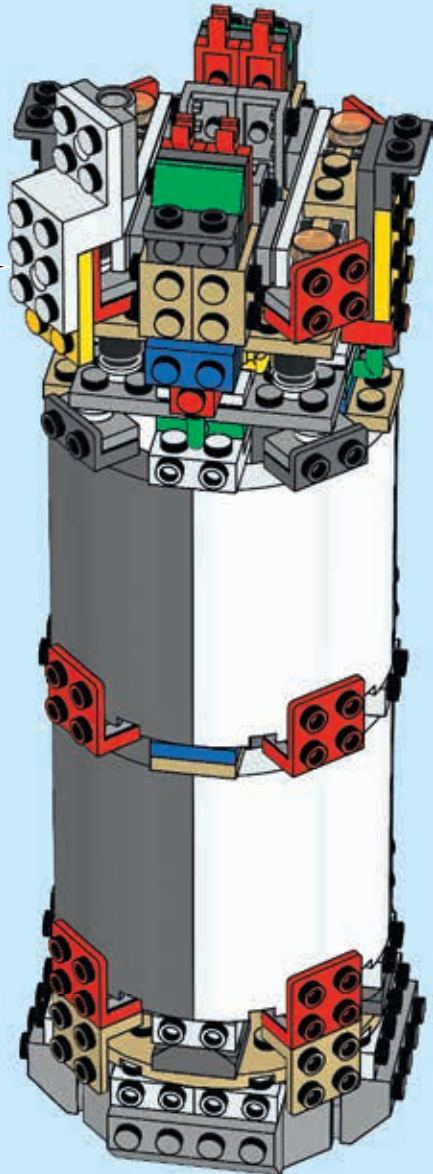
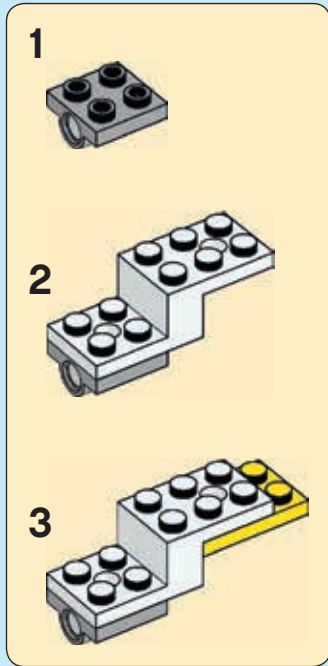

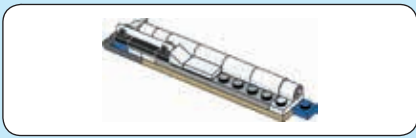

182



183

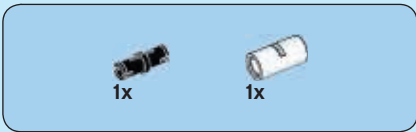
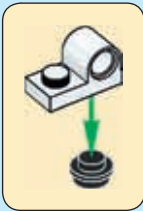

184

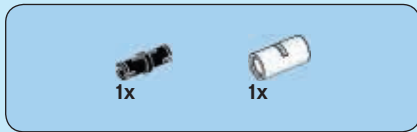
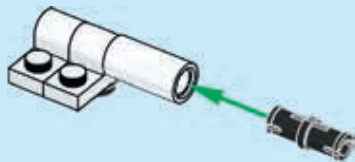

185



186

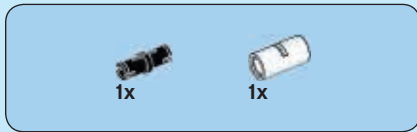
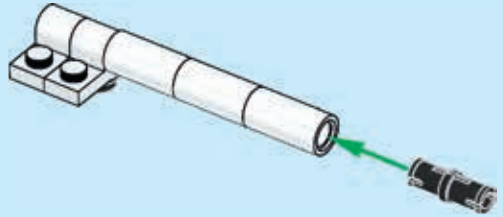

187

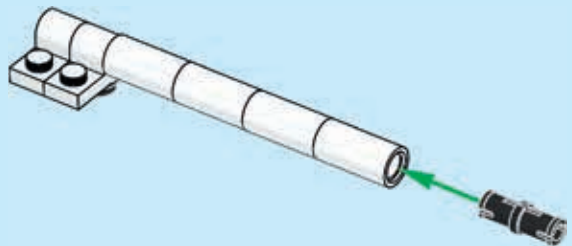



188

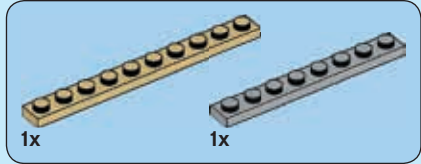
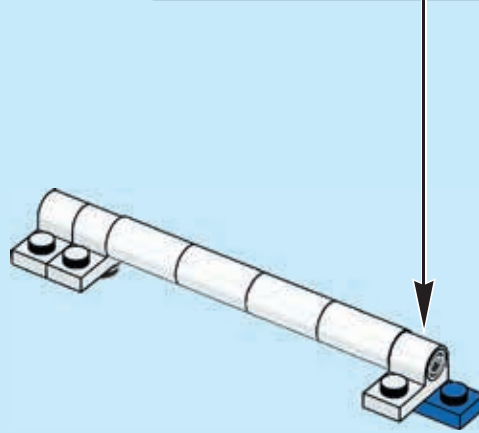

189

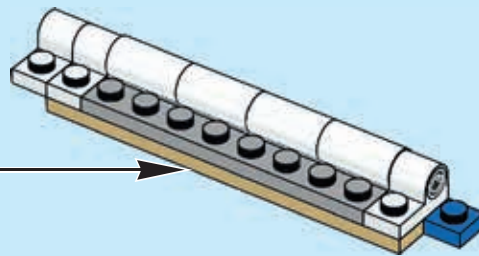
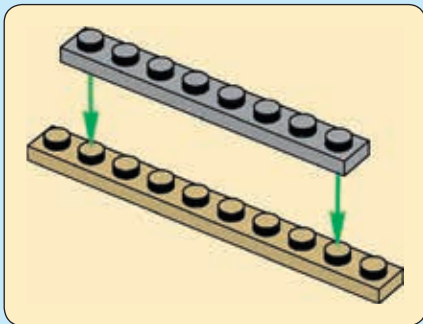



190

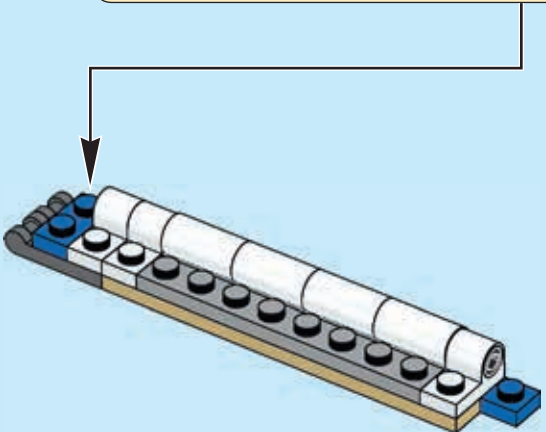
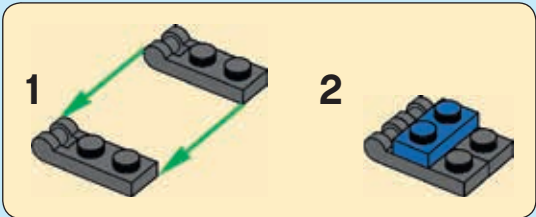

191

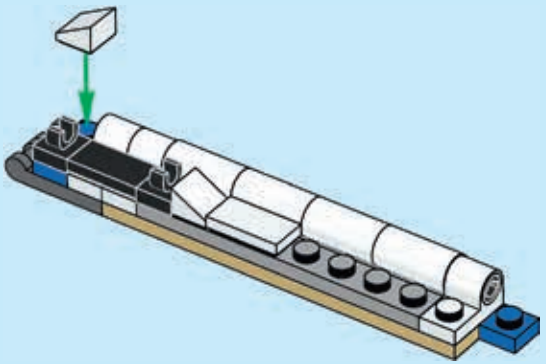



192

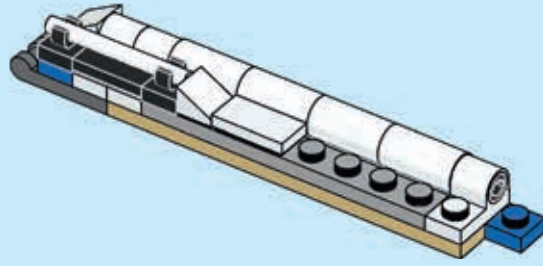

193

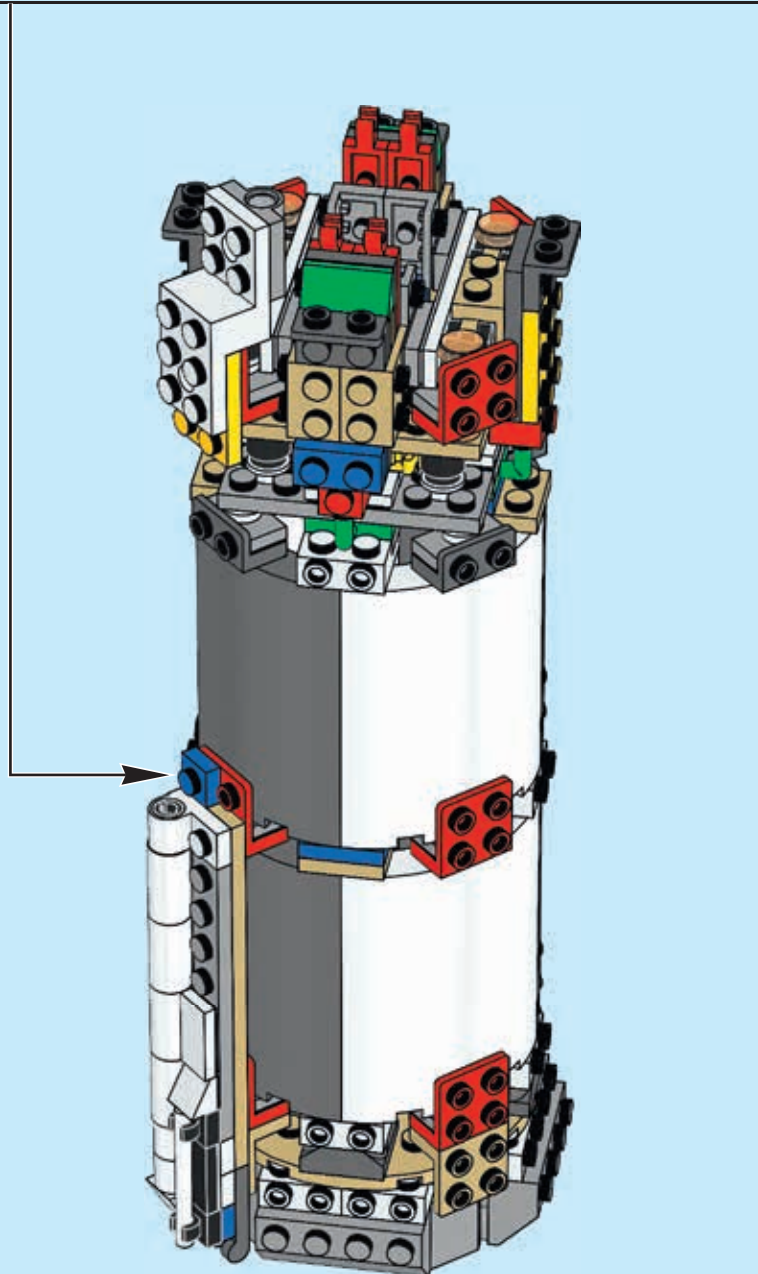



194

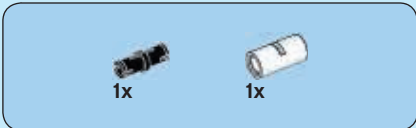

195

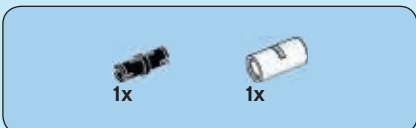
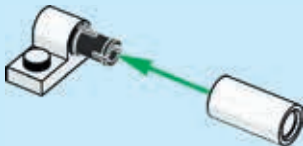

196



197

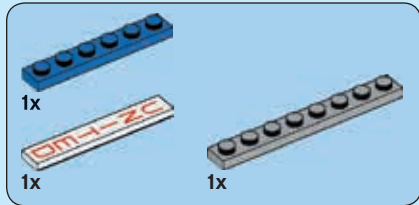

198

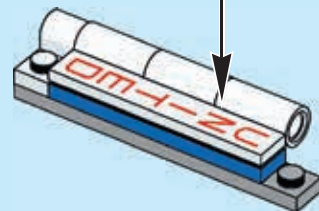
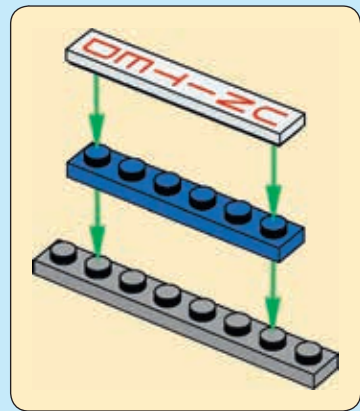

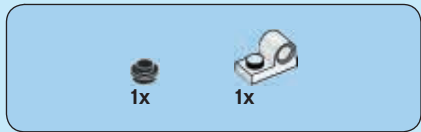

199

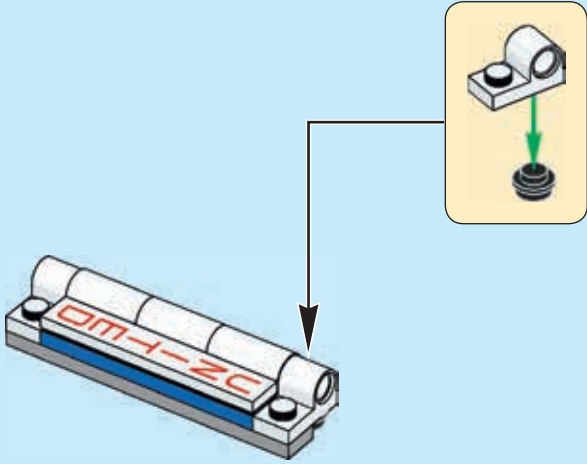

200

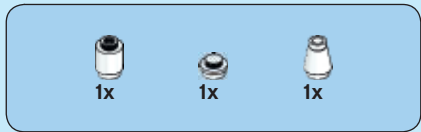
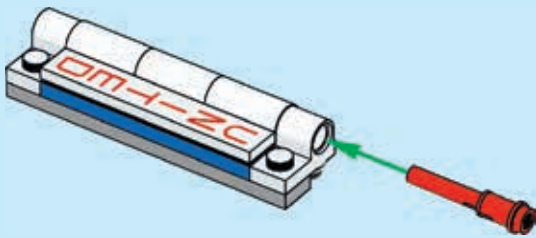

201

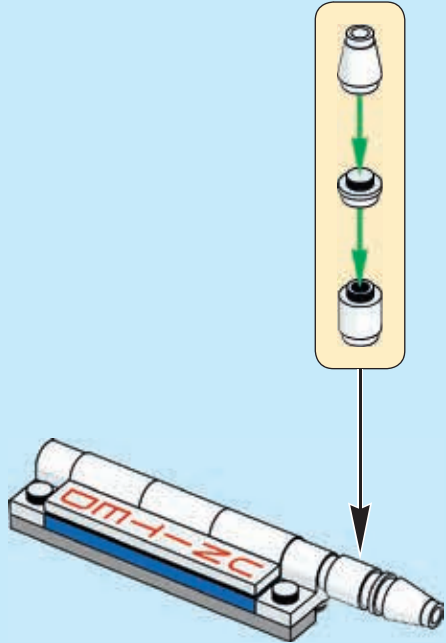

202

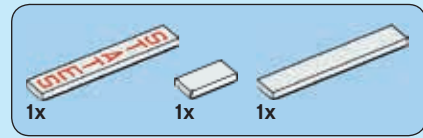
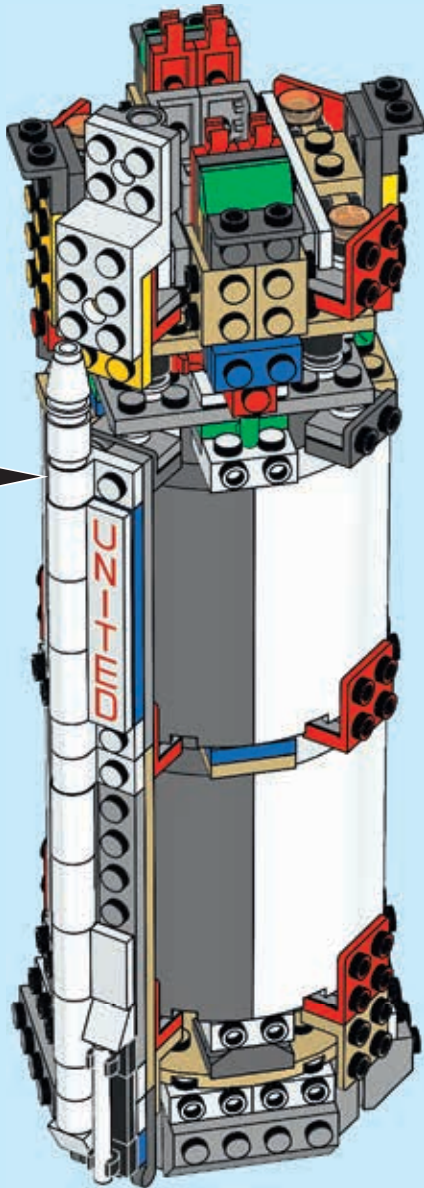

203

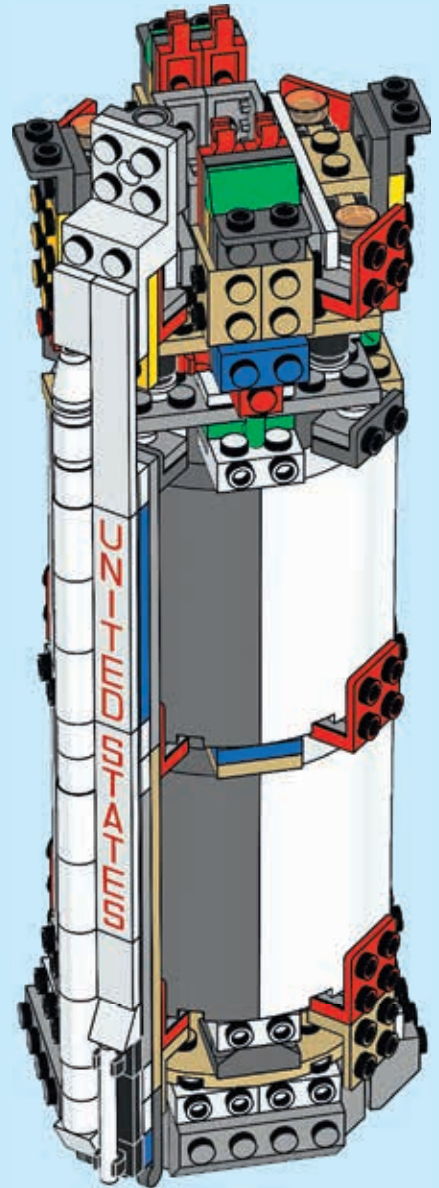

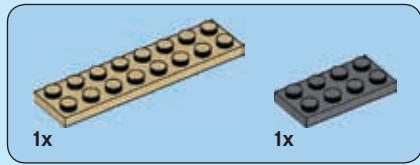

204

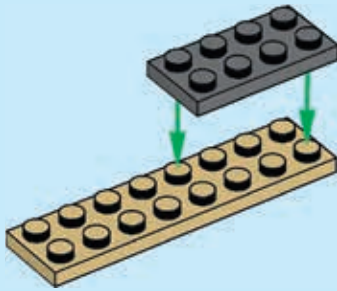

205

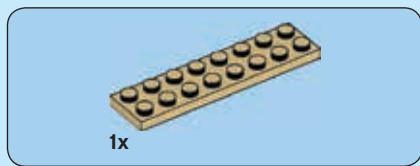
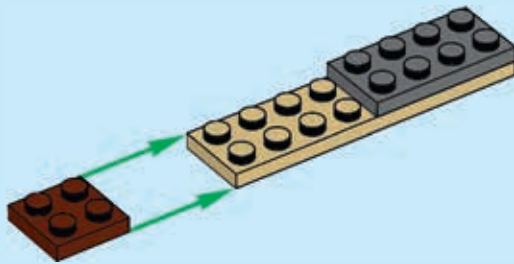

206

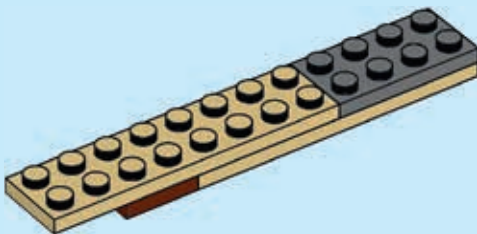

207

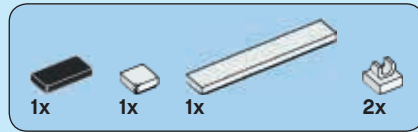
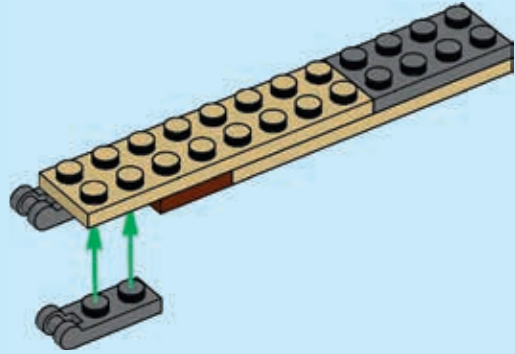

208

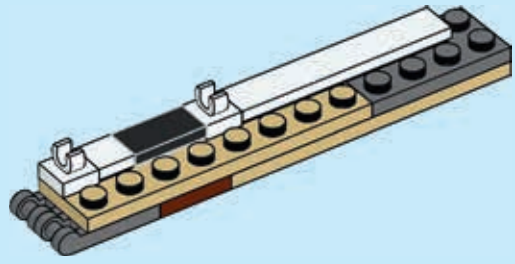

209

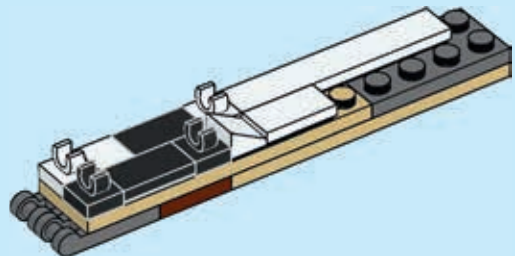

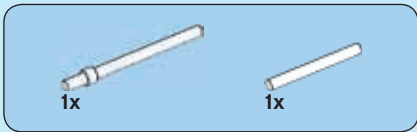

210

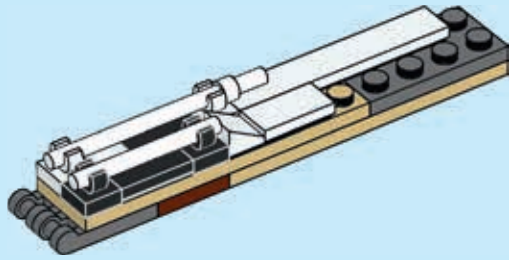

211

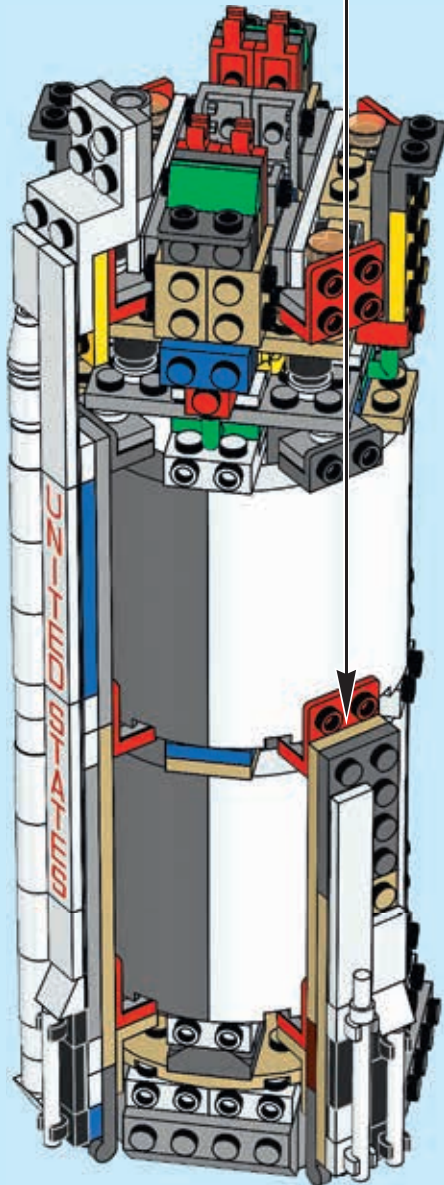

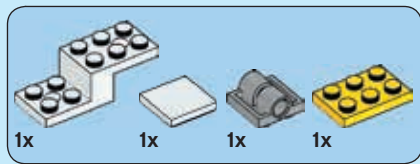

212

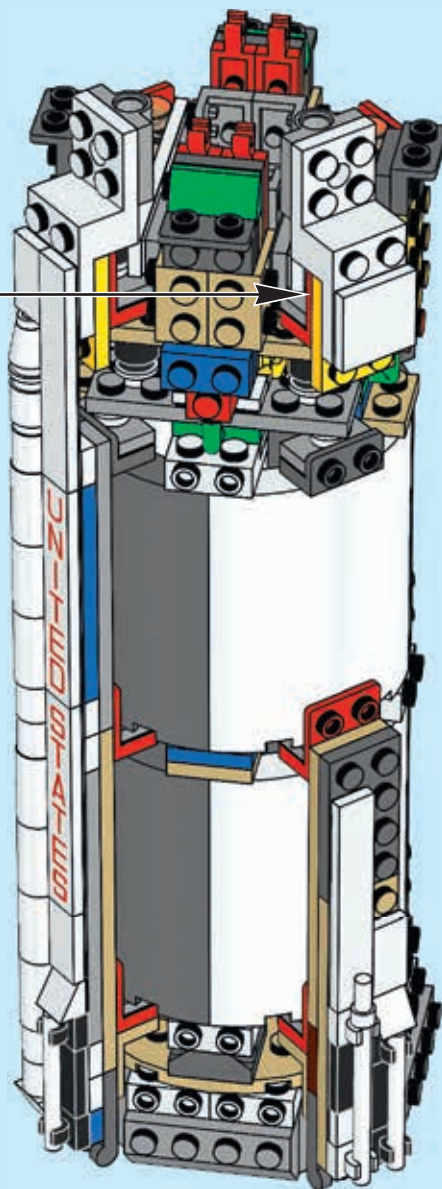
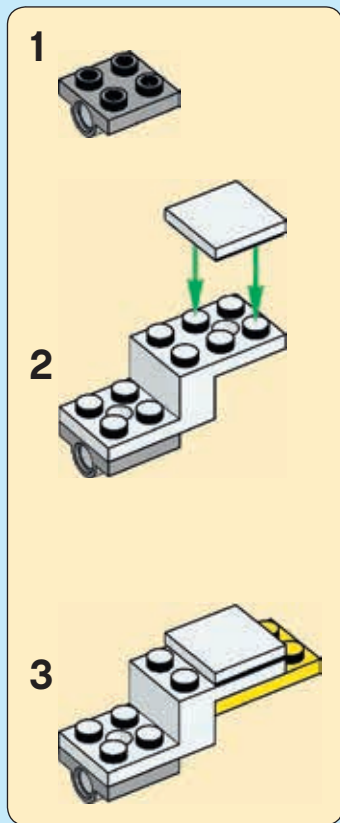

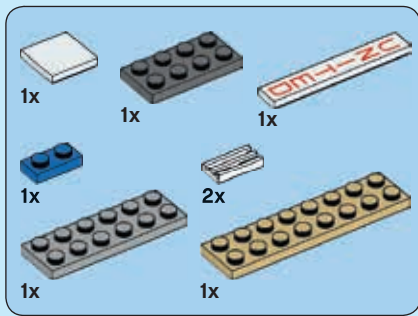

213

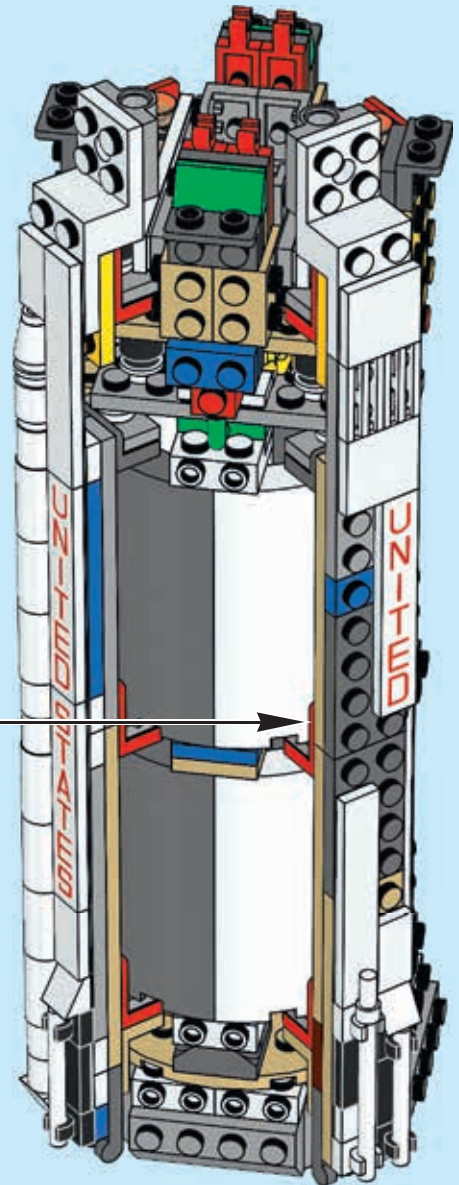
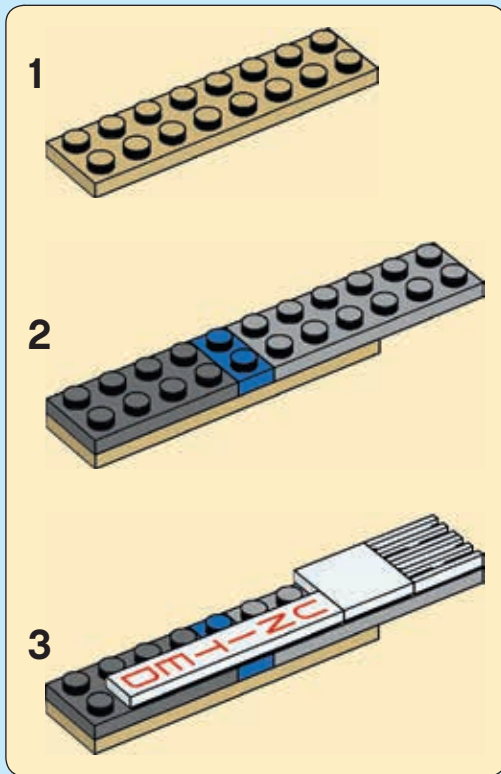

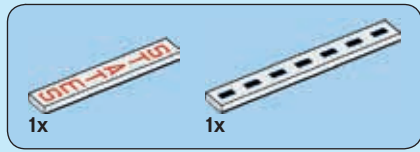

214

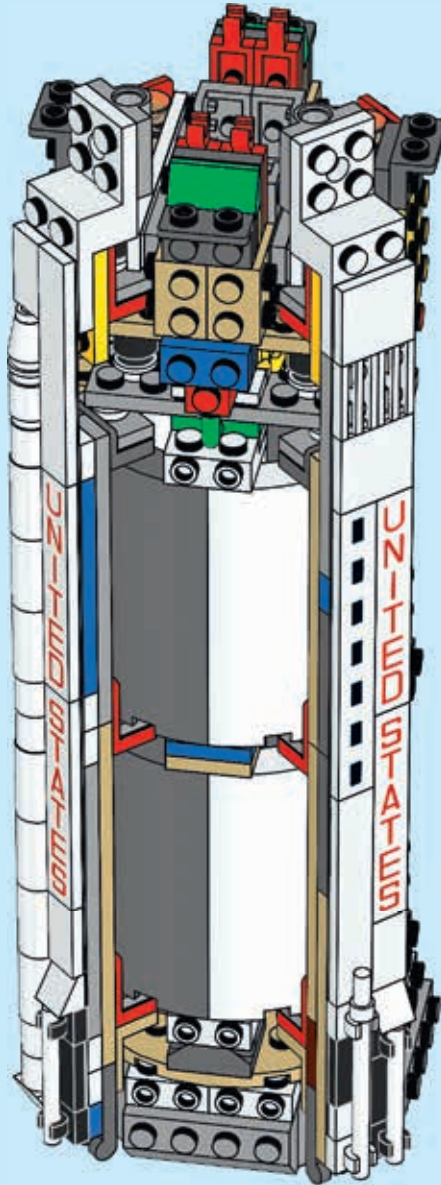

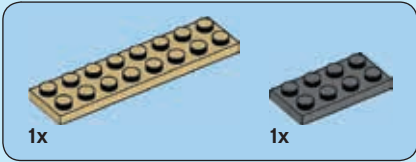

215

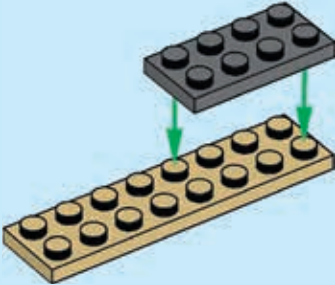

216

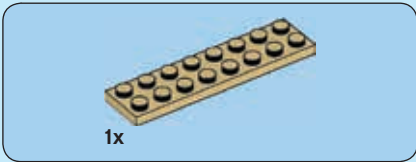
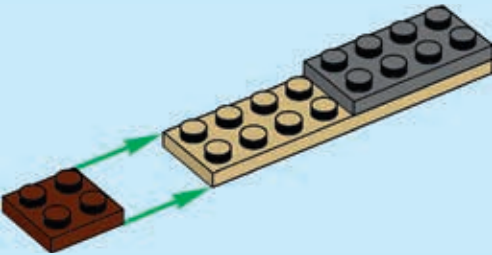

217

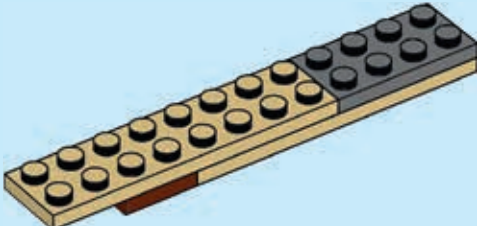

218

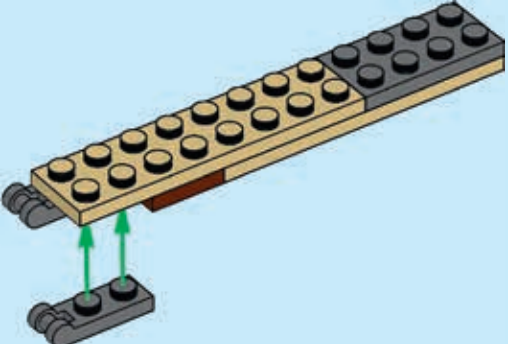

219

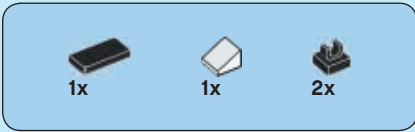
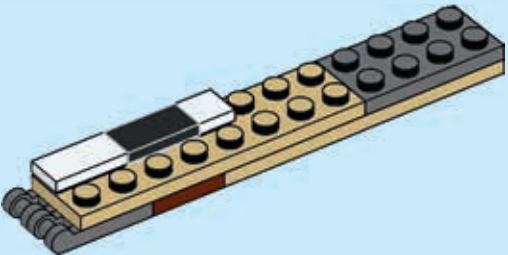

220

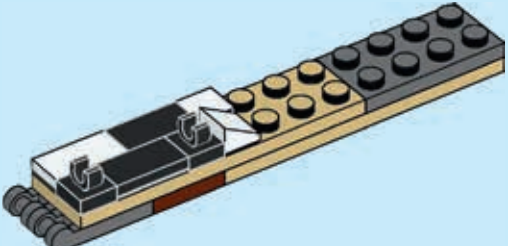

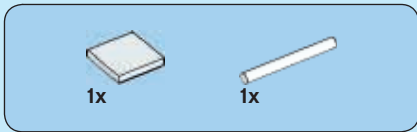

221

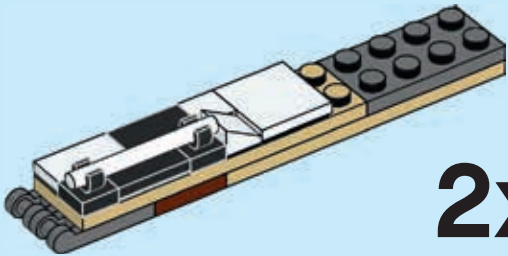

222

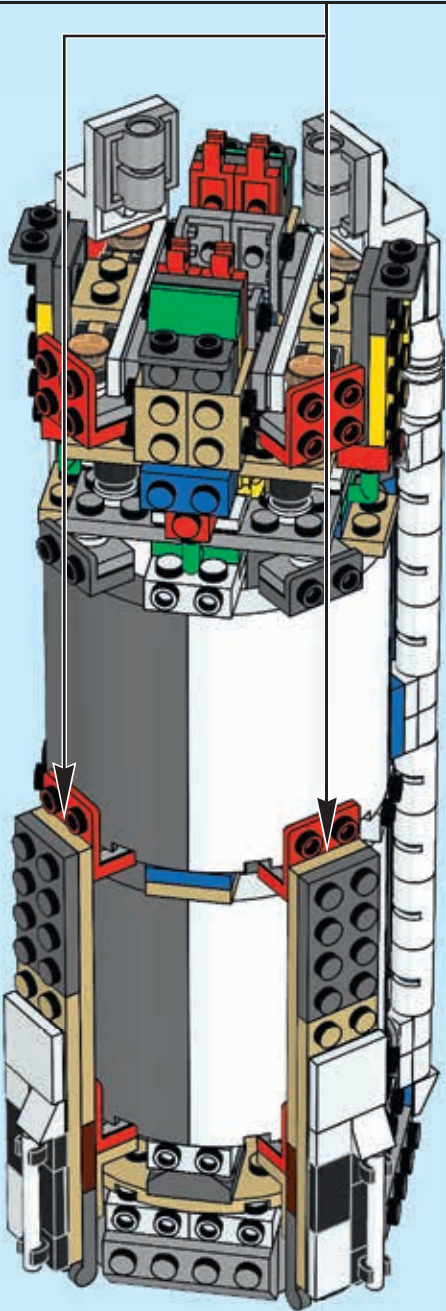
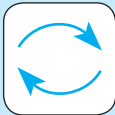

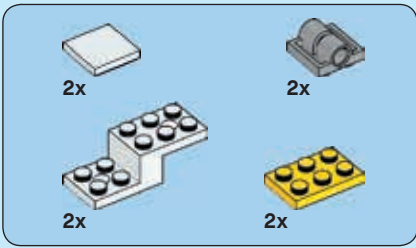

223

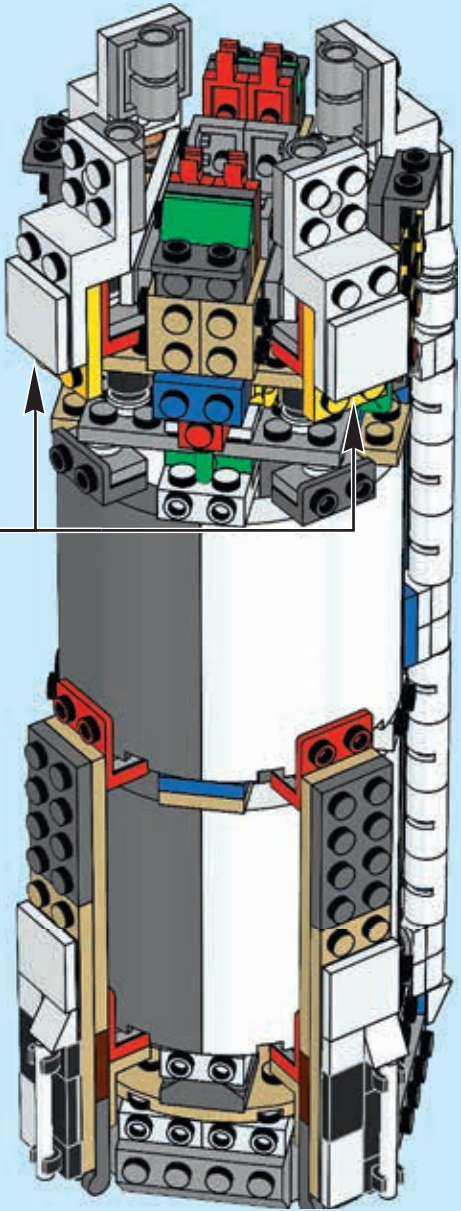
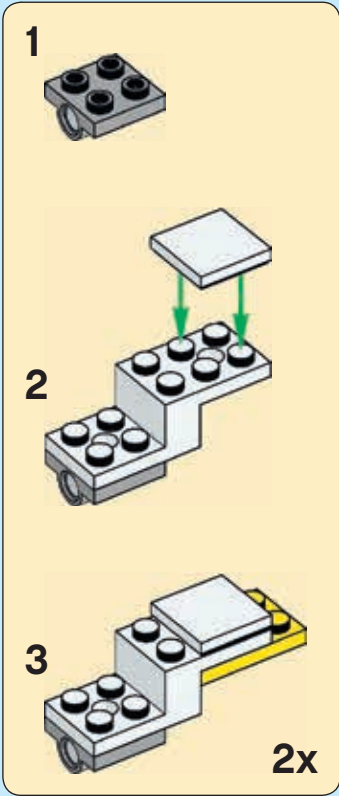

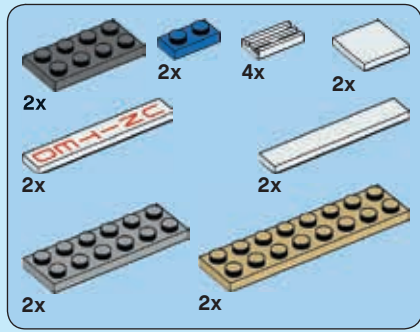

224

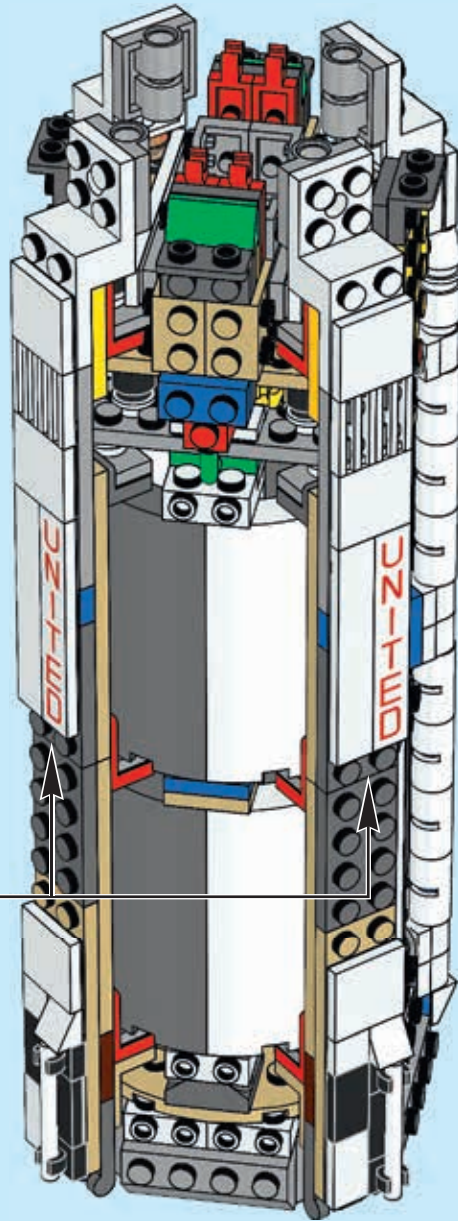
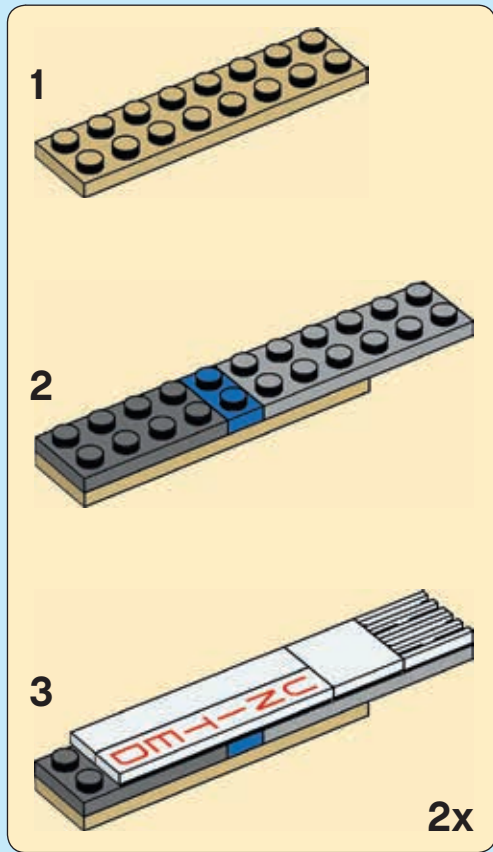

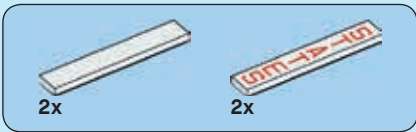

225

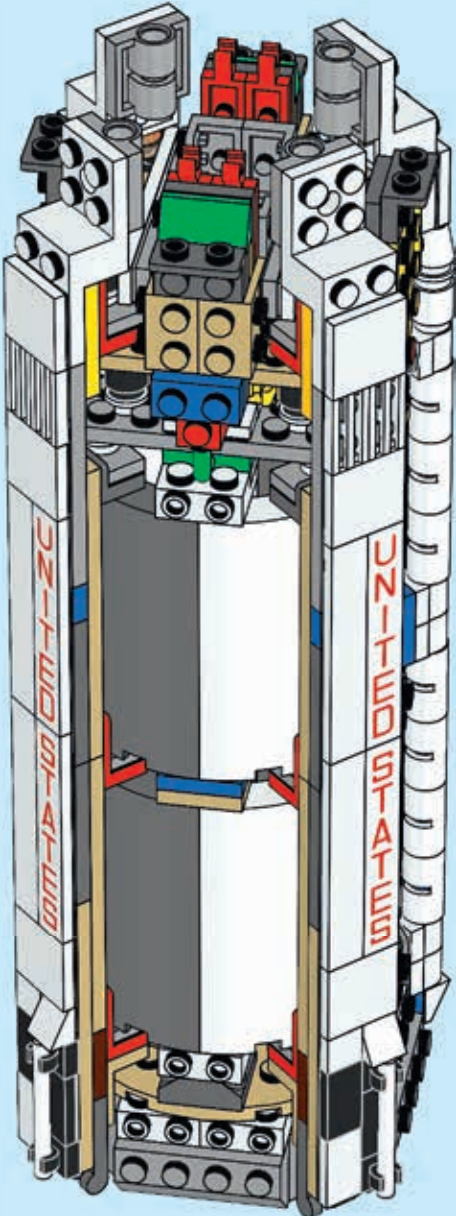

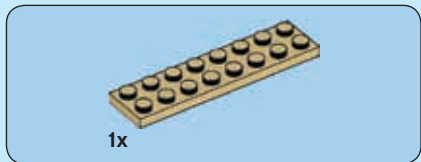
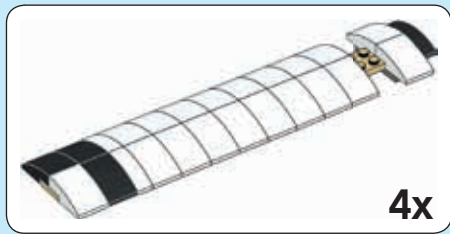
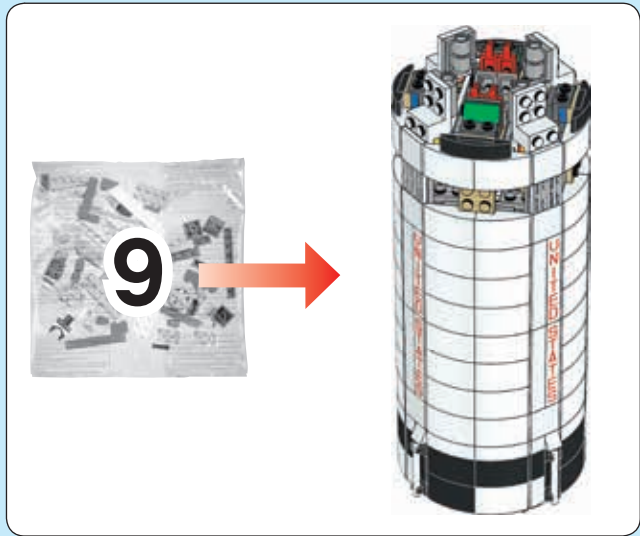

226

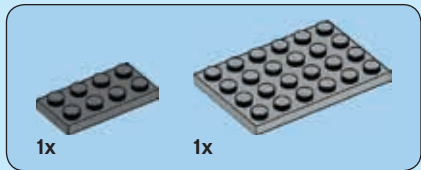
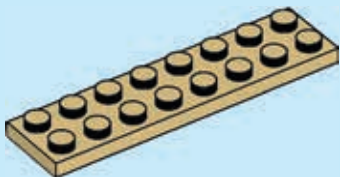

227

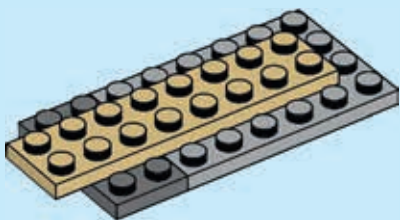

228



229

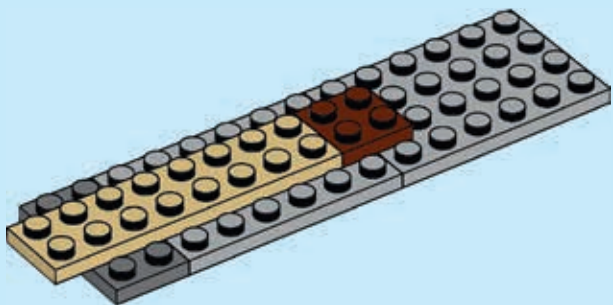

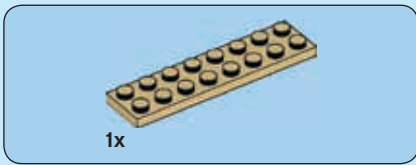

230

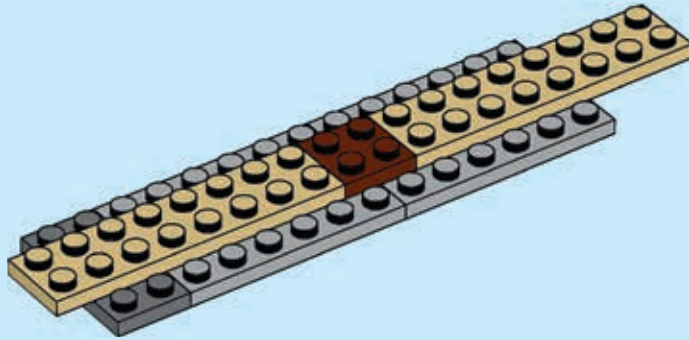

231

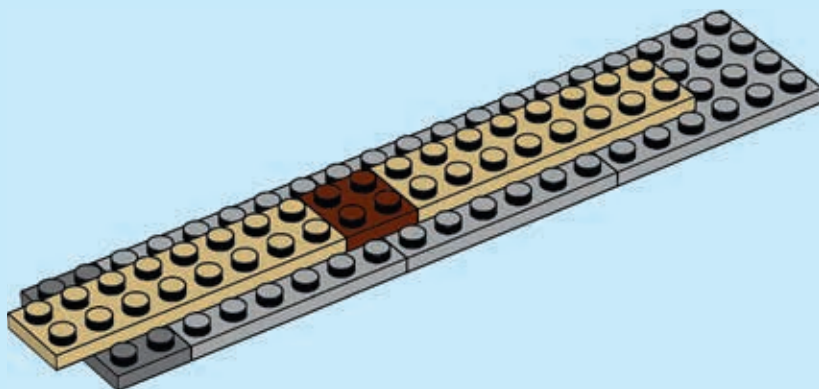

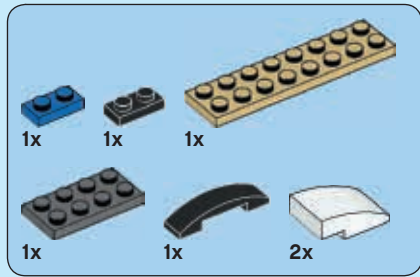

232

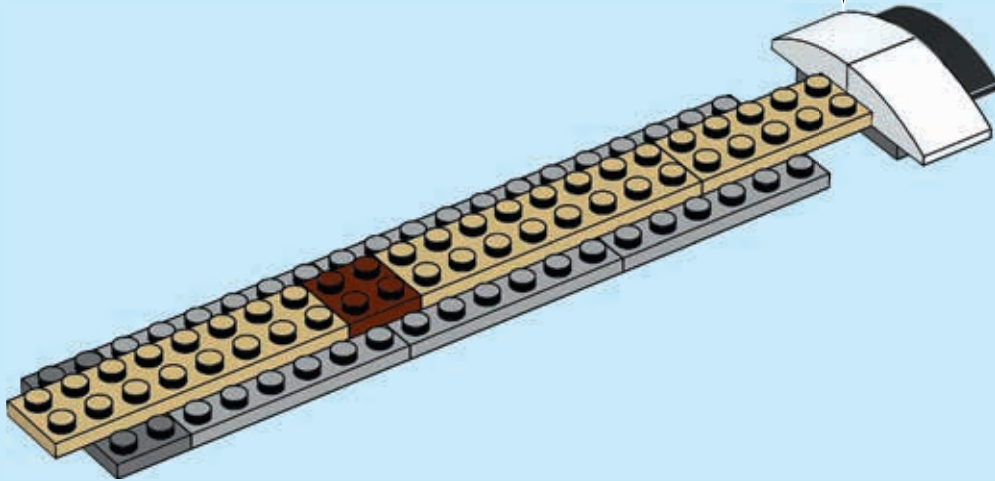
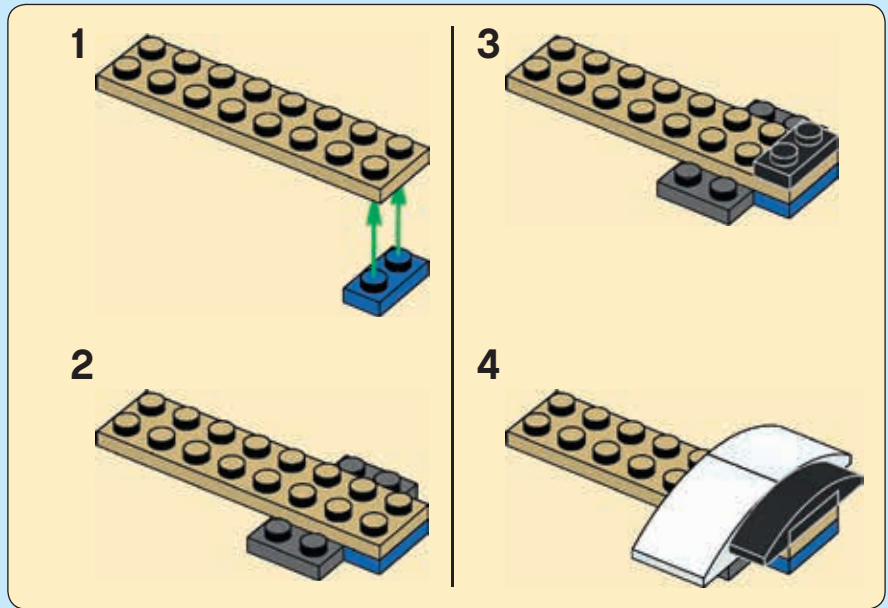

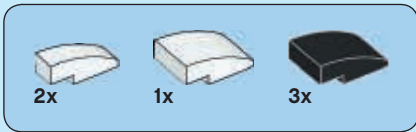

233

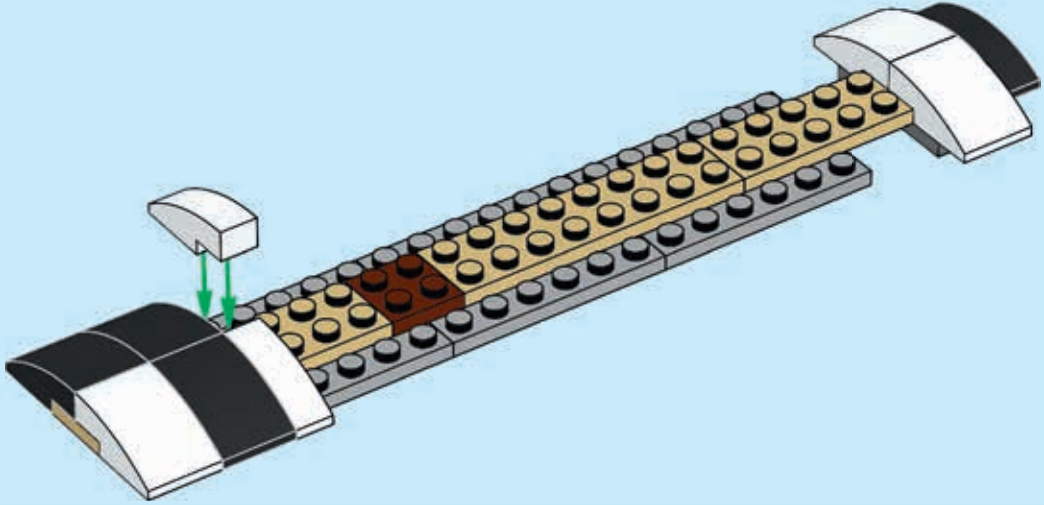

234

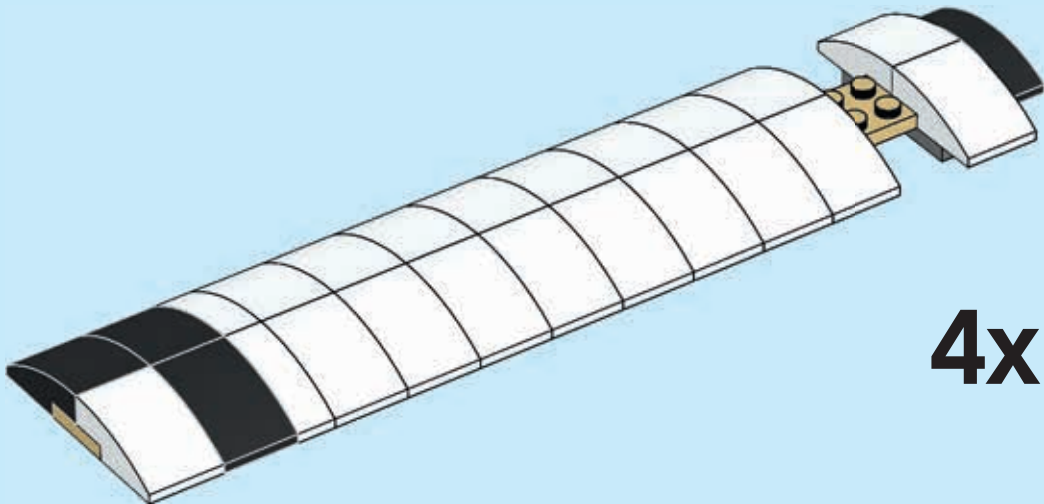

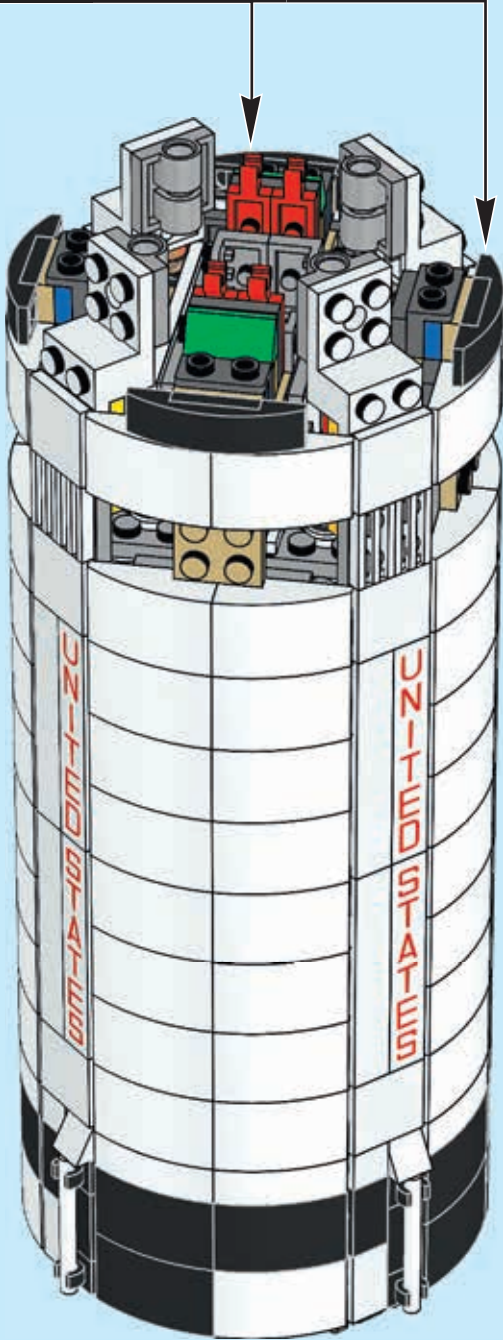



10

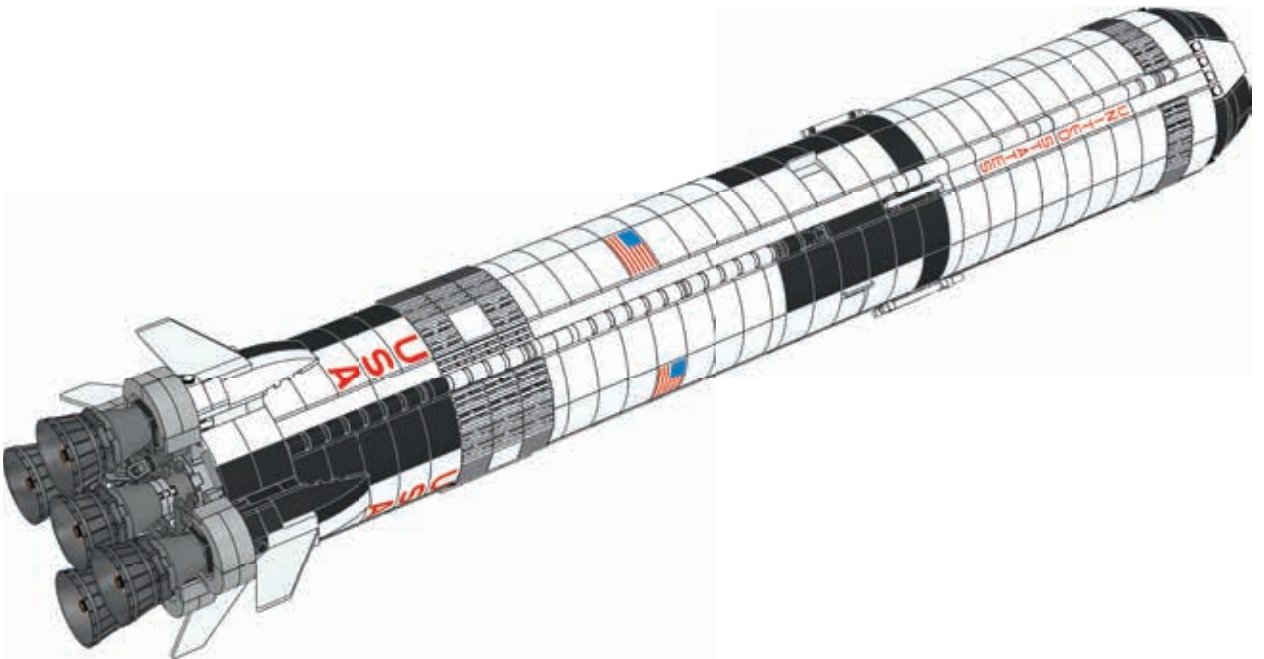



236

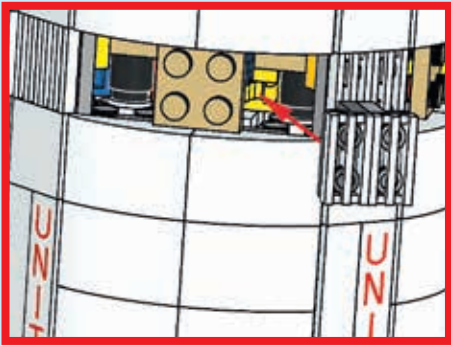
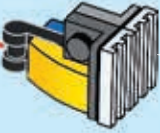
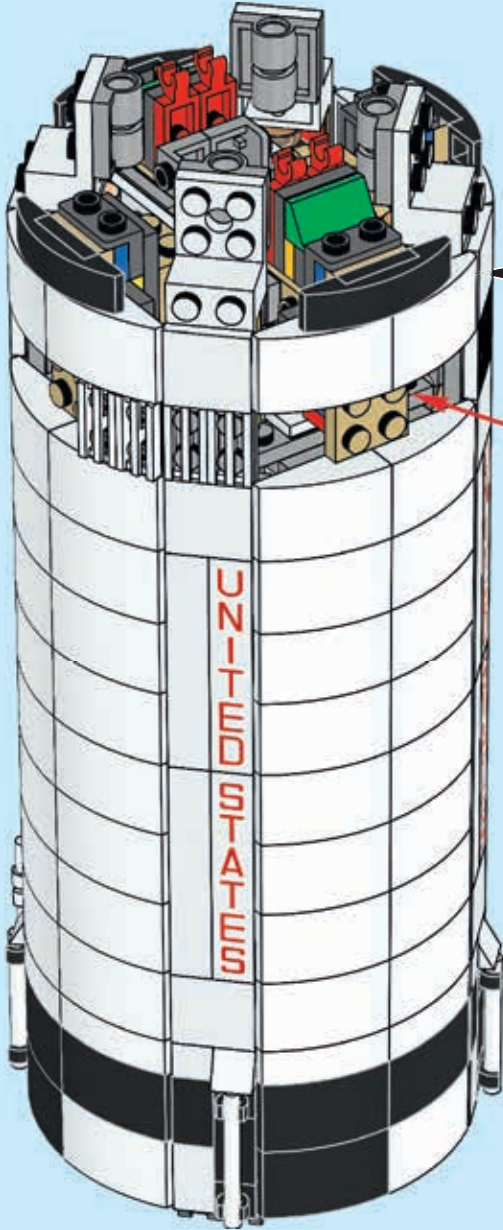
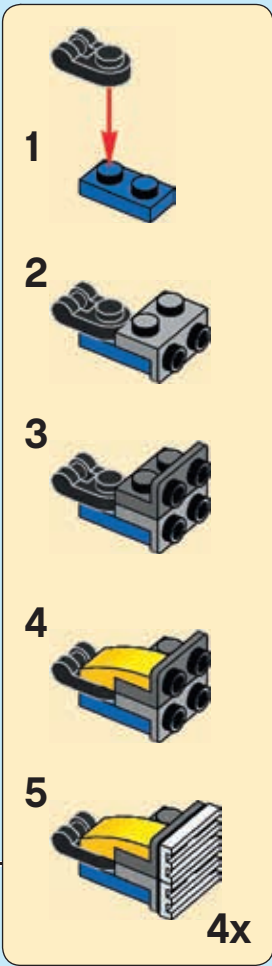

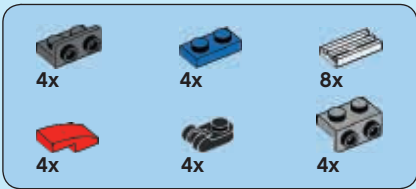

237

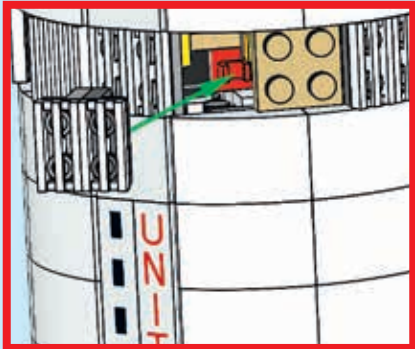
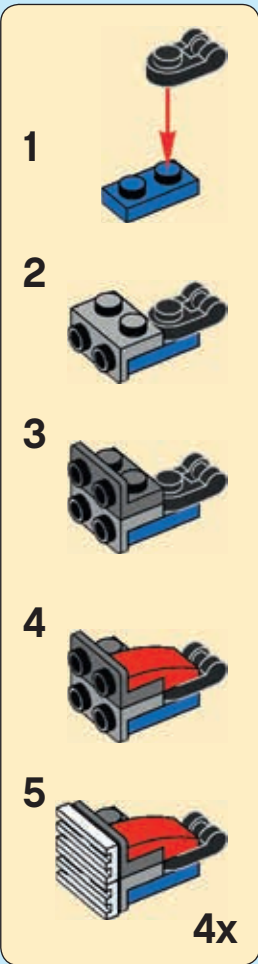
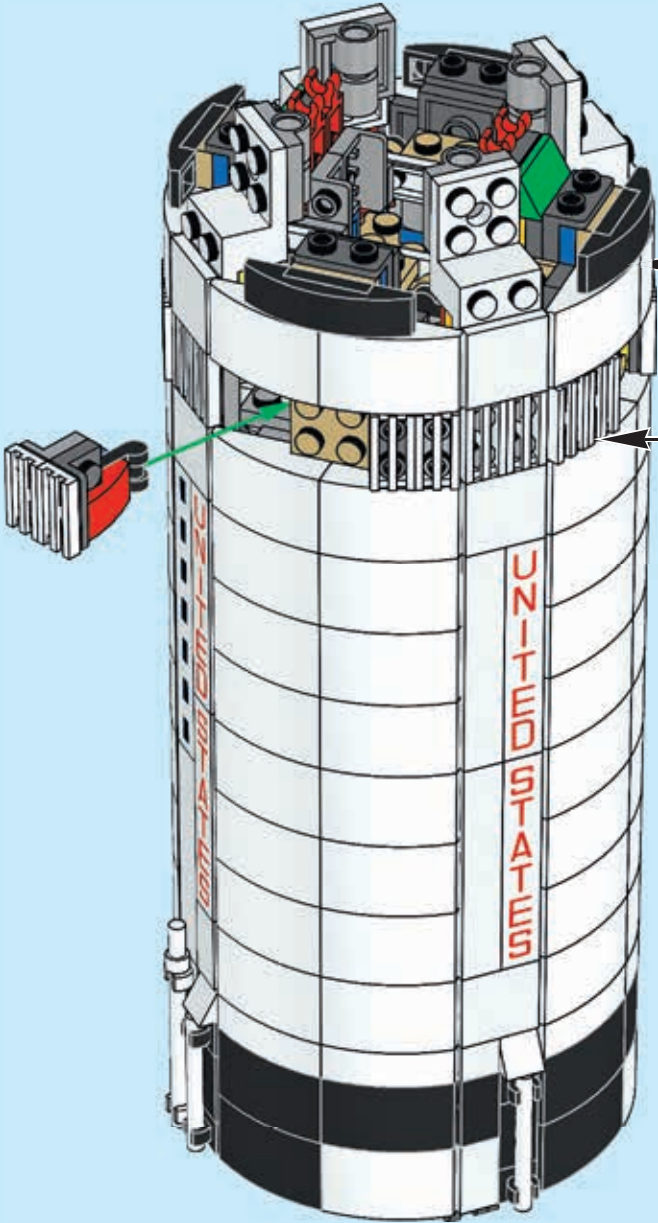

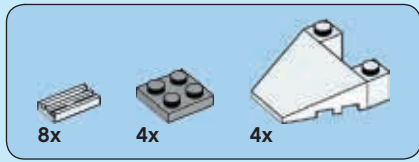

238

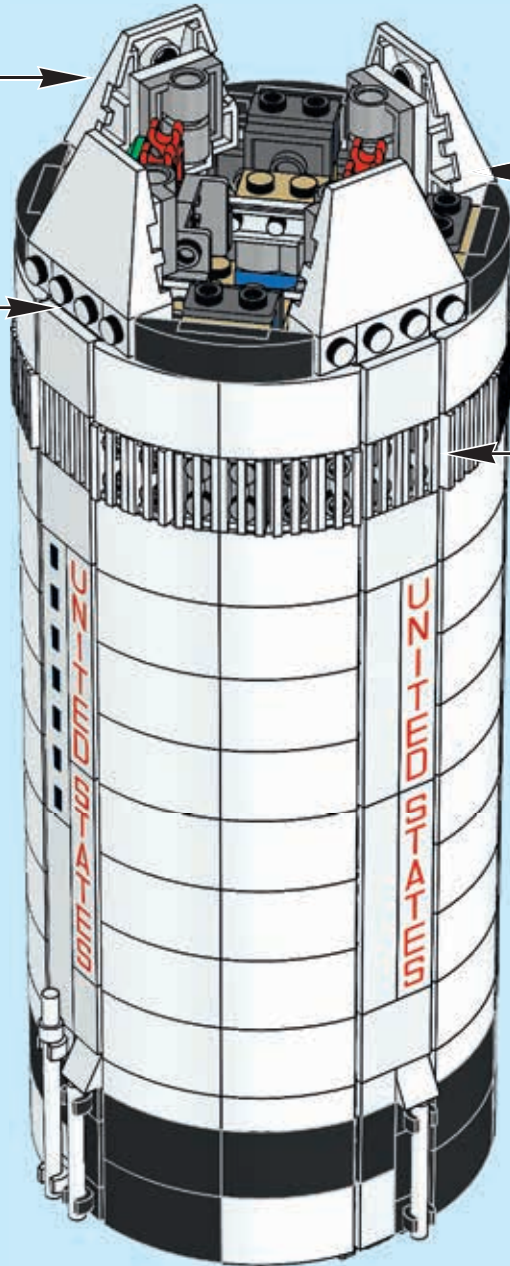
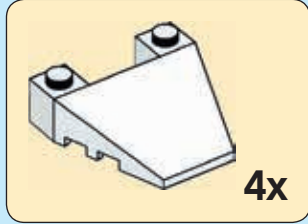
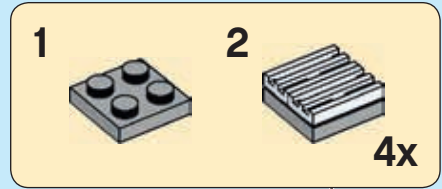

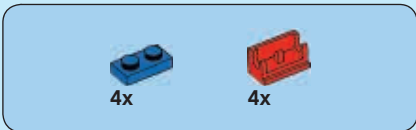

239

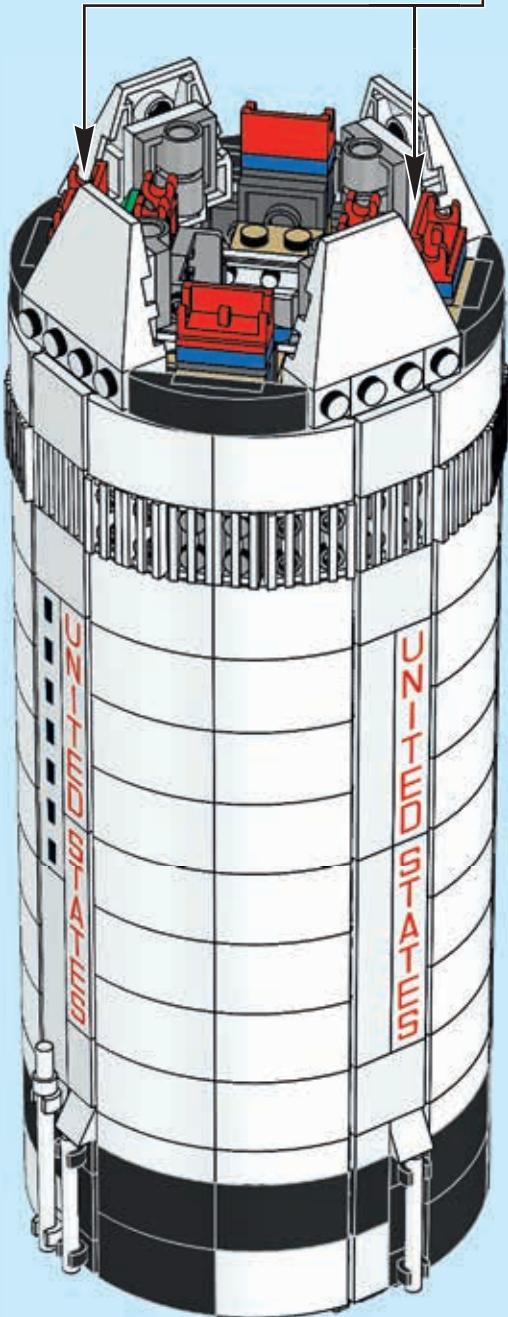
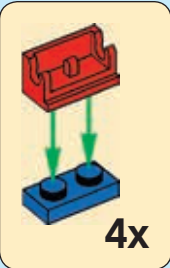

240

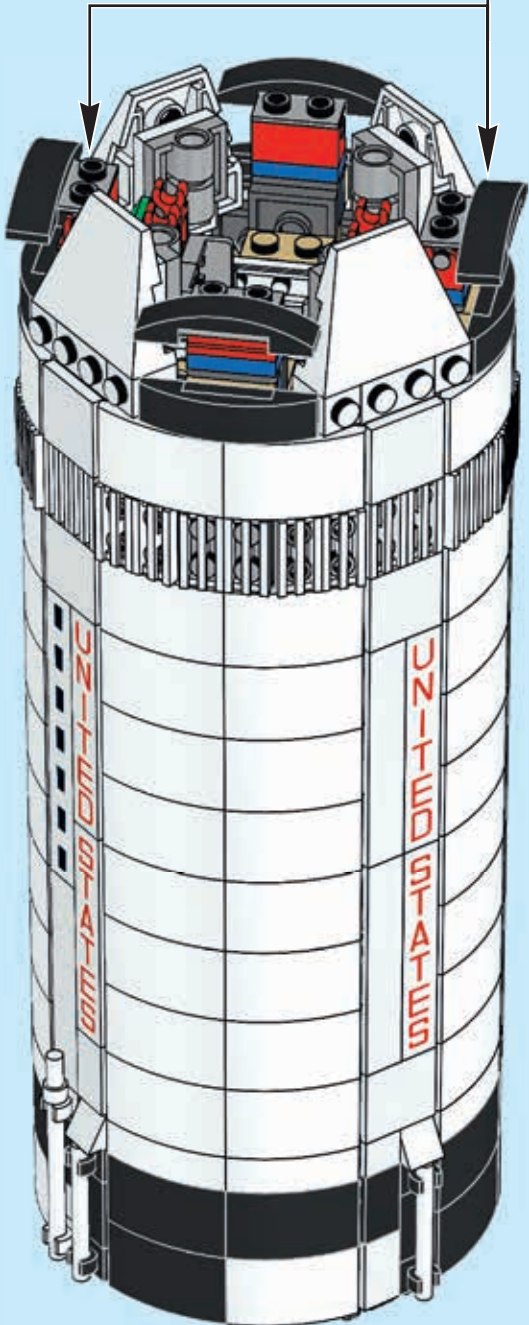
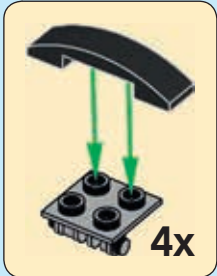



241

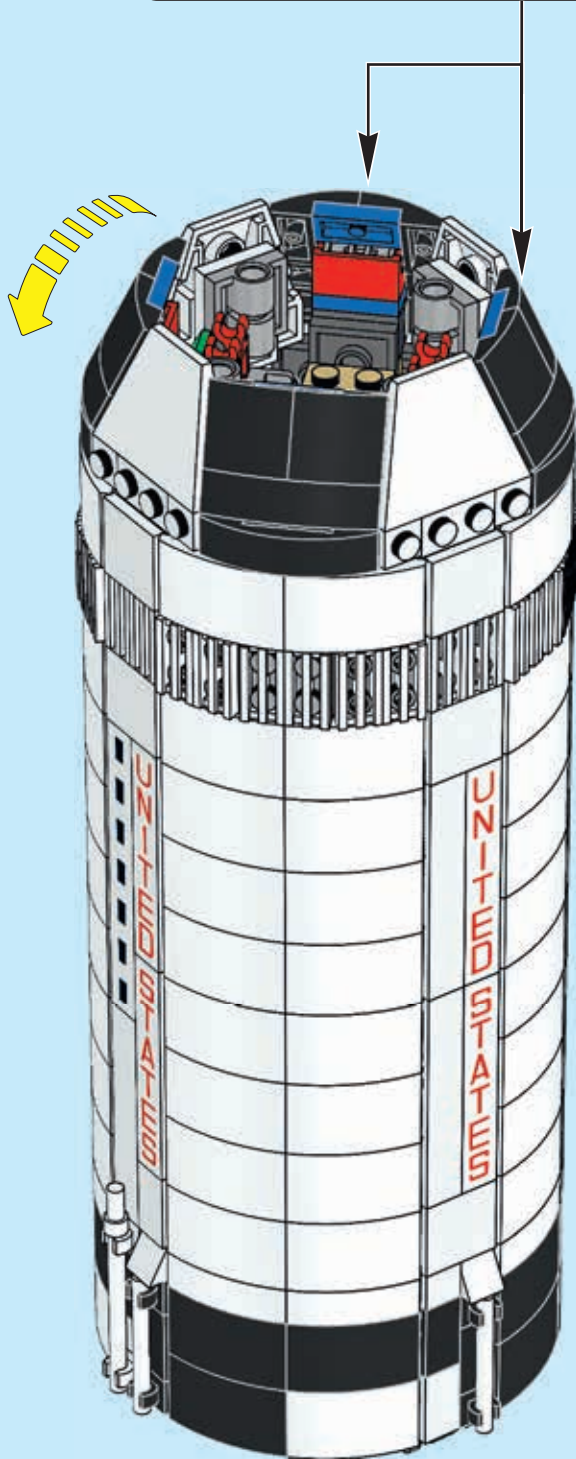
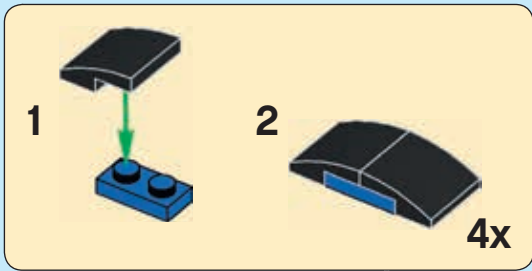



242

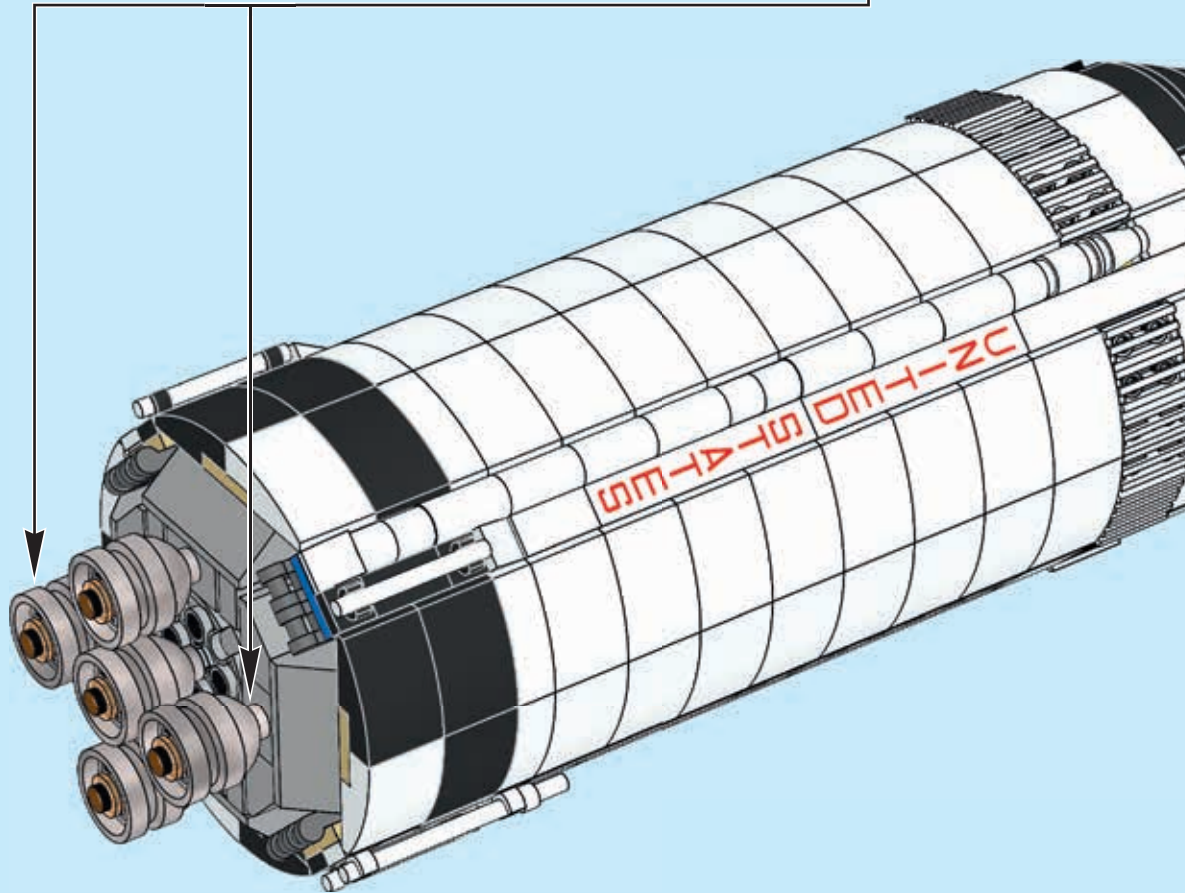
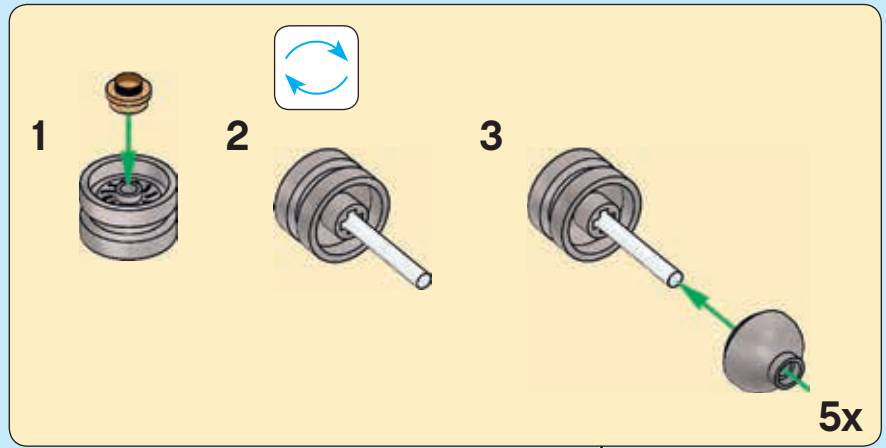

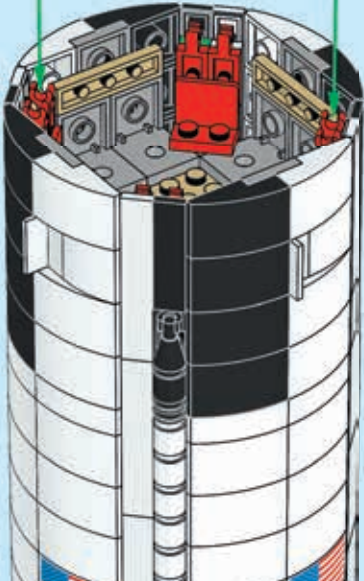
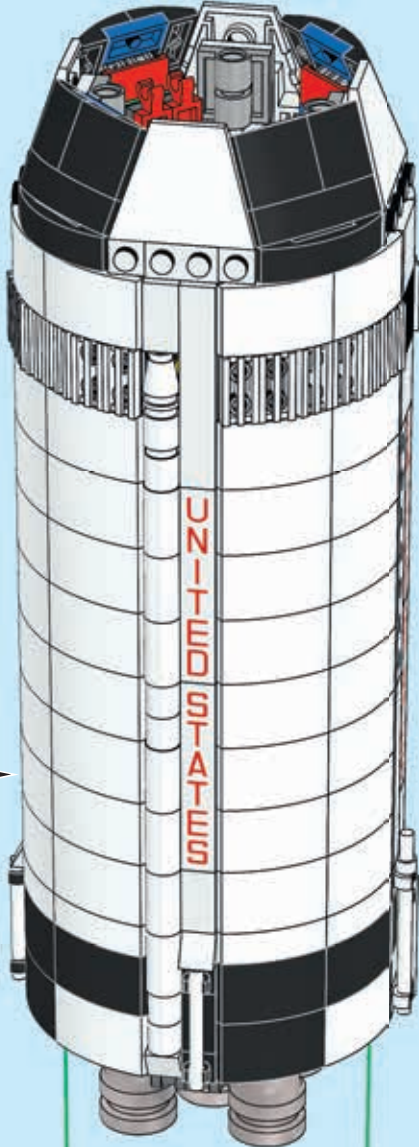

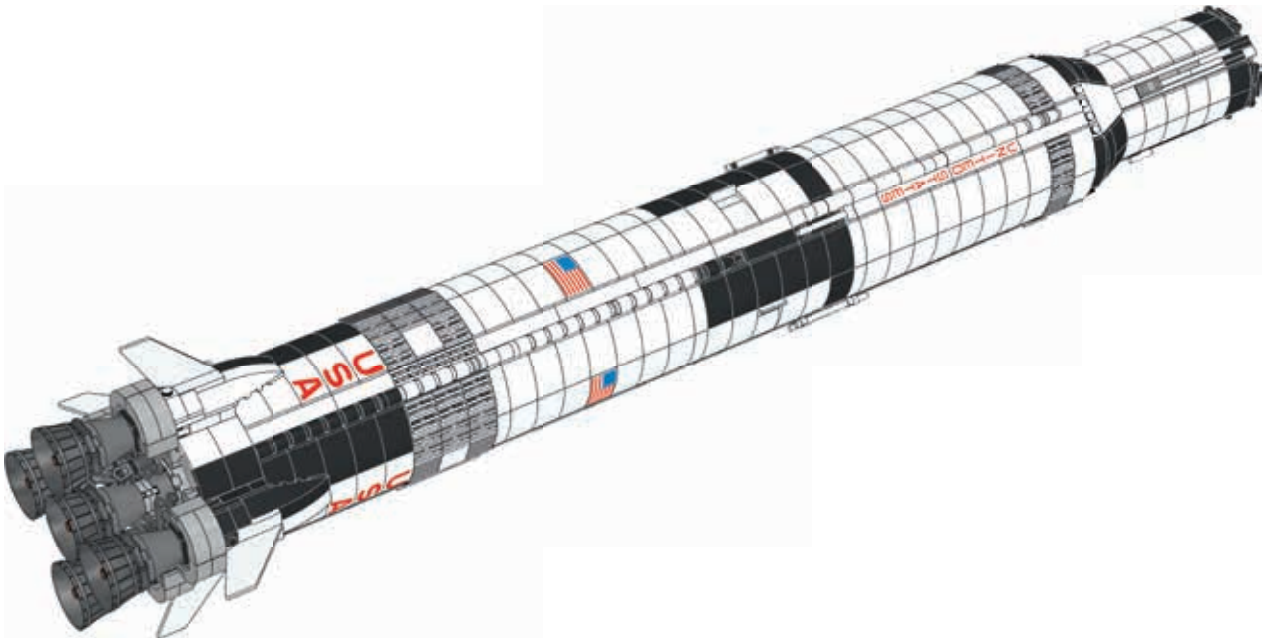

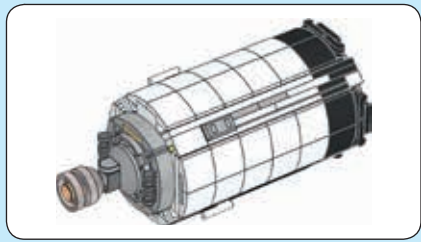

244

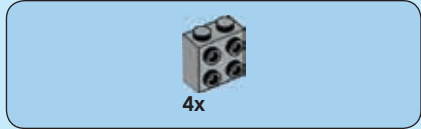
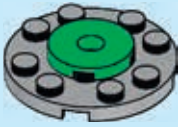

245

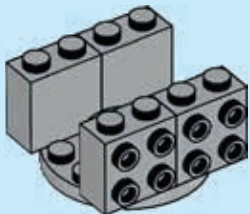

246

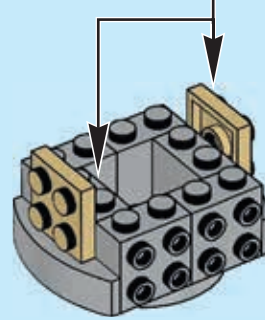
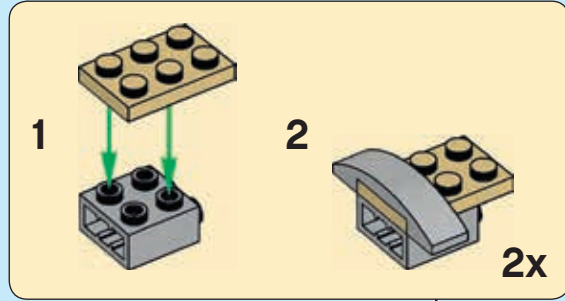

247

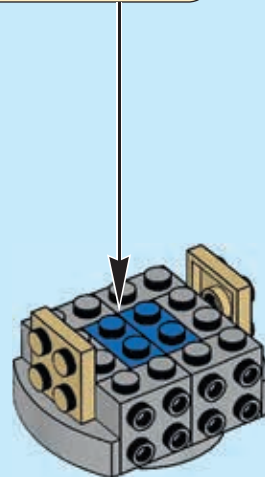

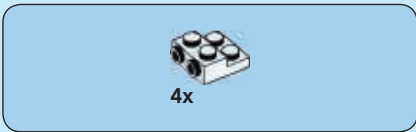

248

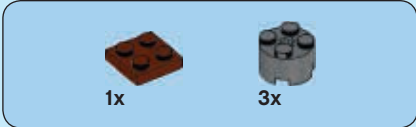
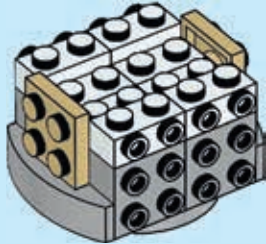

249

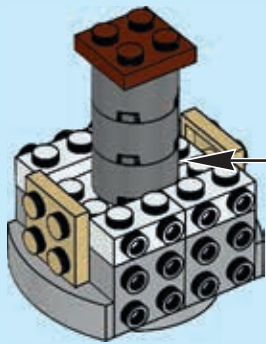
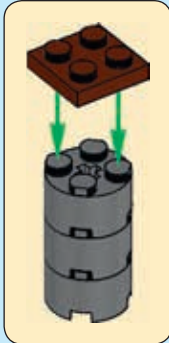

250

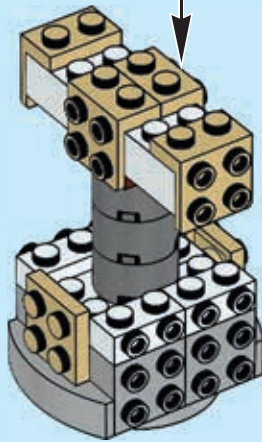
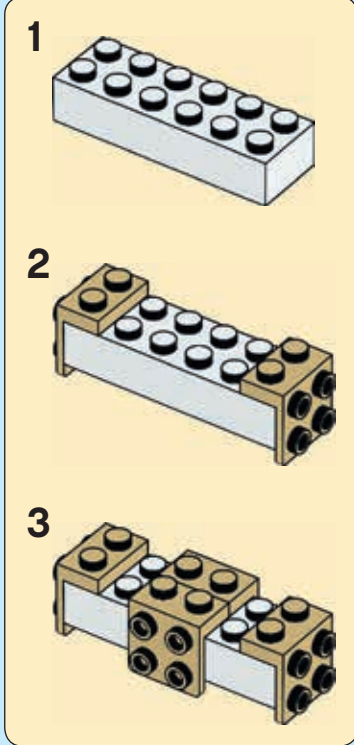



251

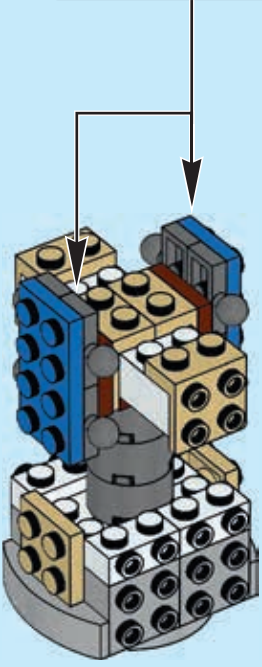
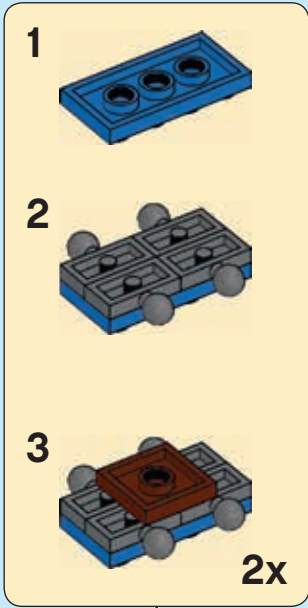

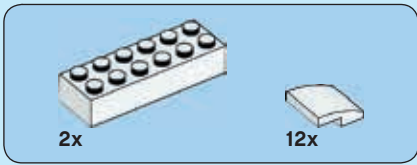

252

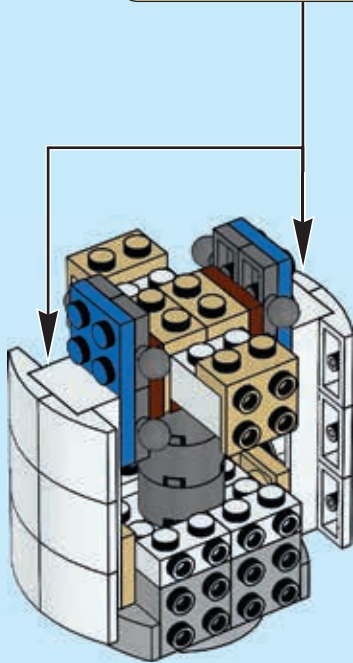
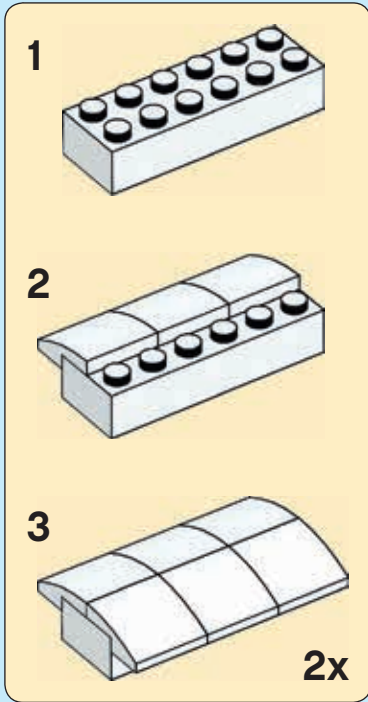

253

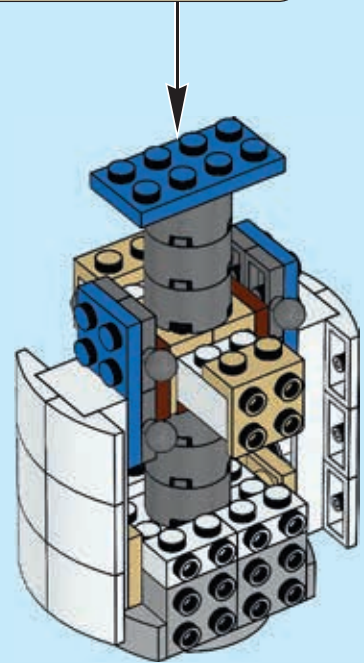
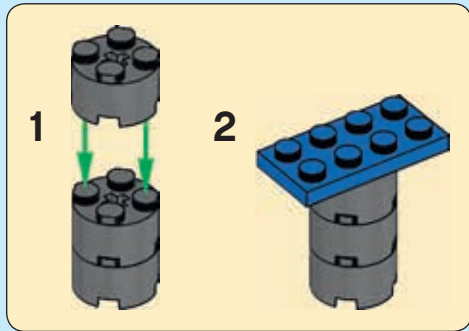



254

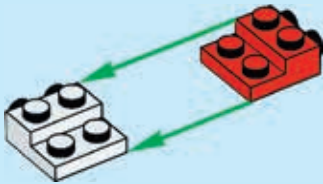

255



256



257

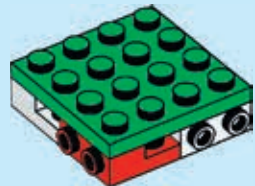



258

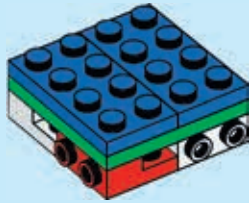

259

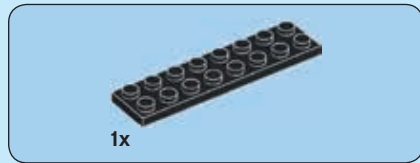
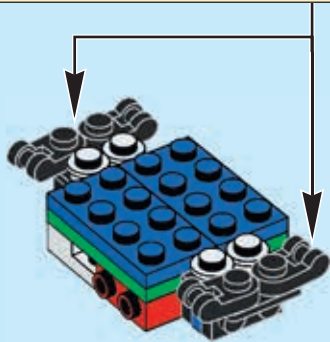
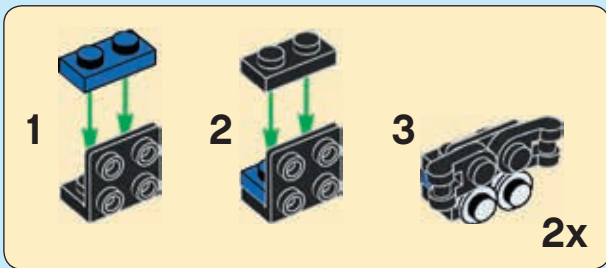

260

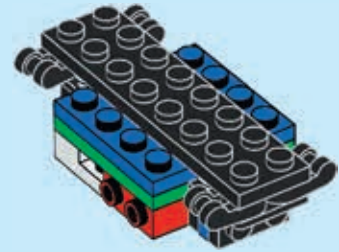

261

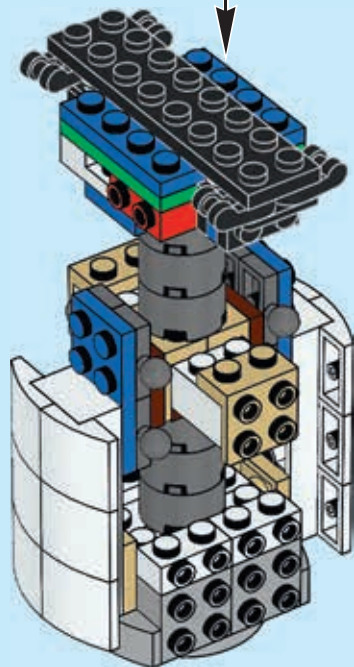

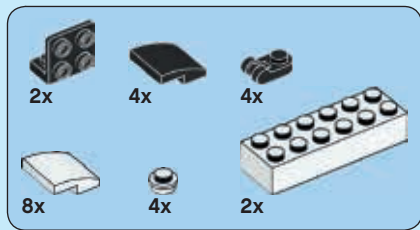

262

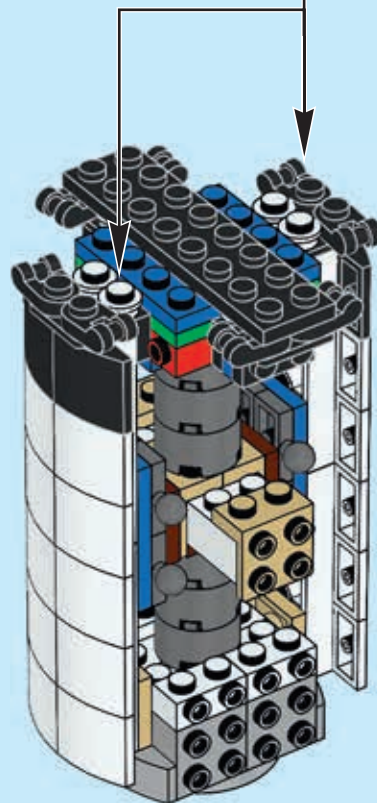
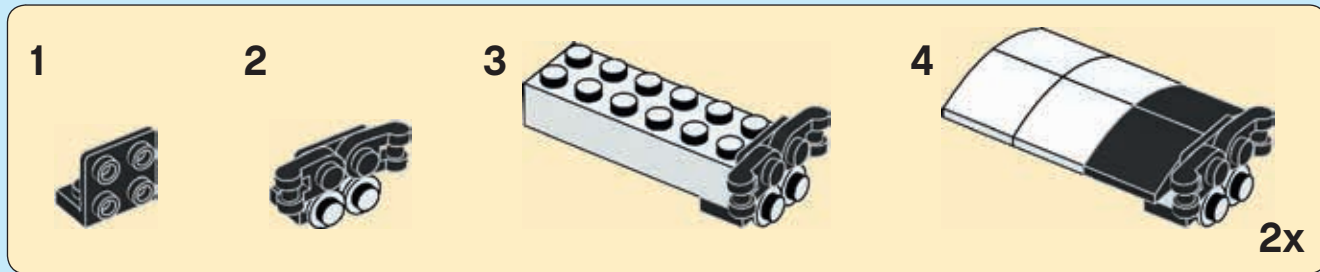



263

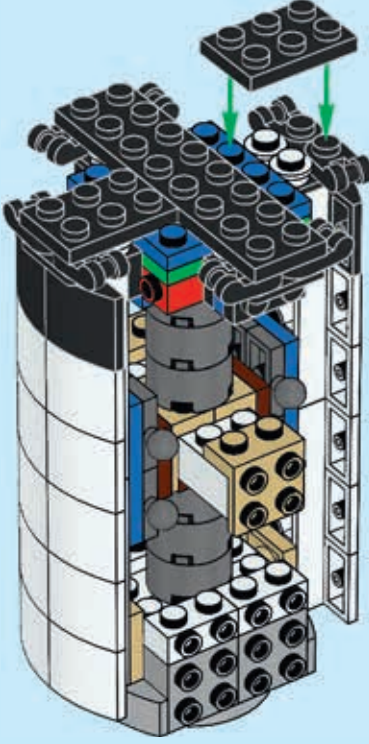

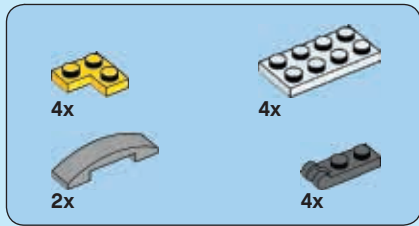

264

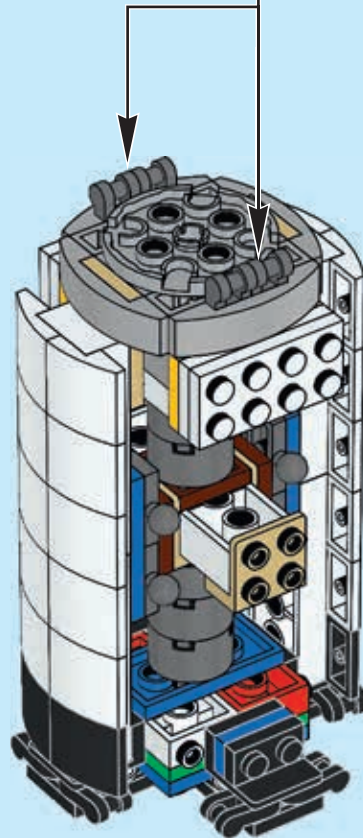
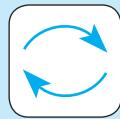
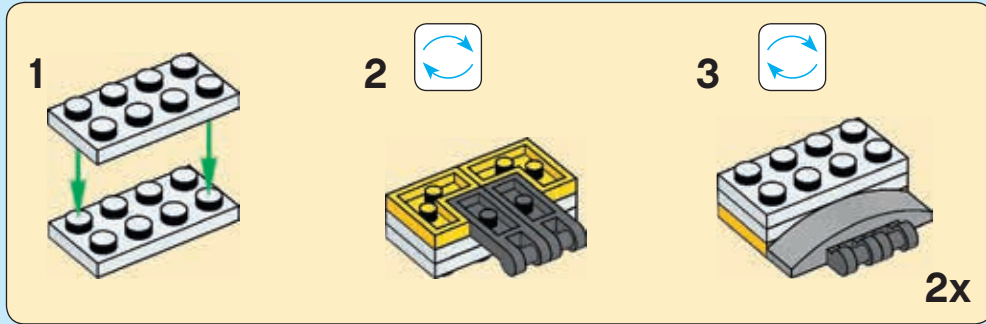



2x

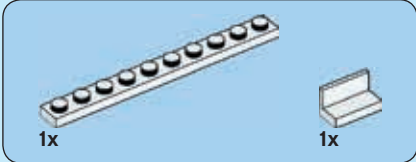

1x

1x

265

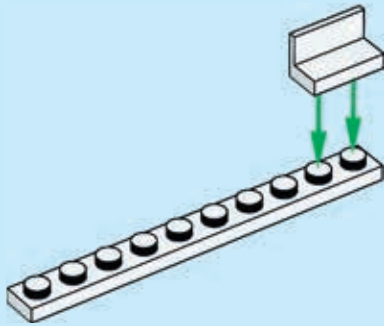

1x

1x

266

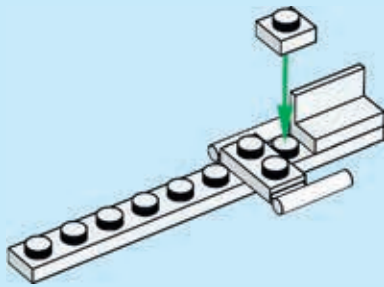

1x

2x

267

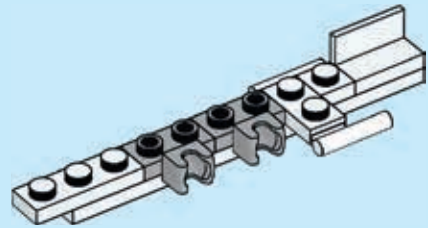

1x

1x

1x

268

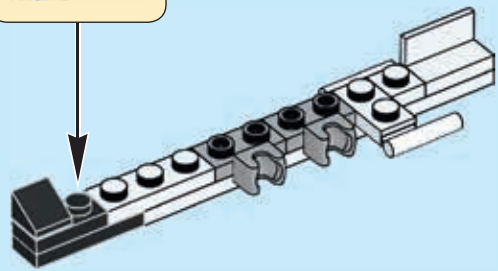
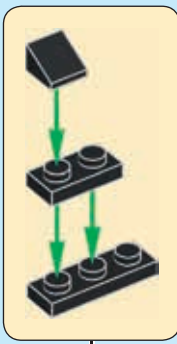

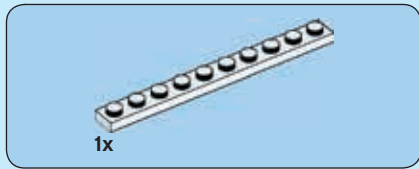

269

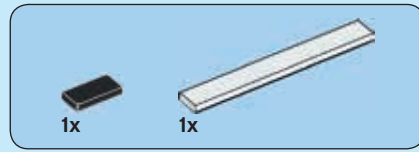
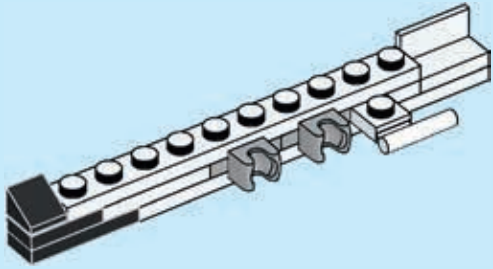

270

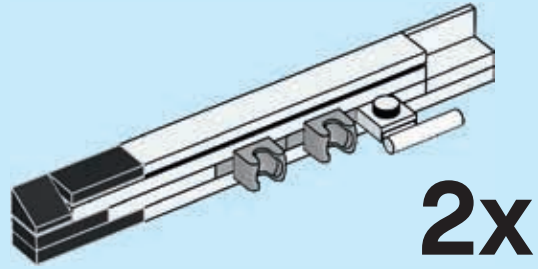

271

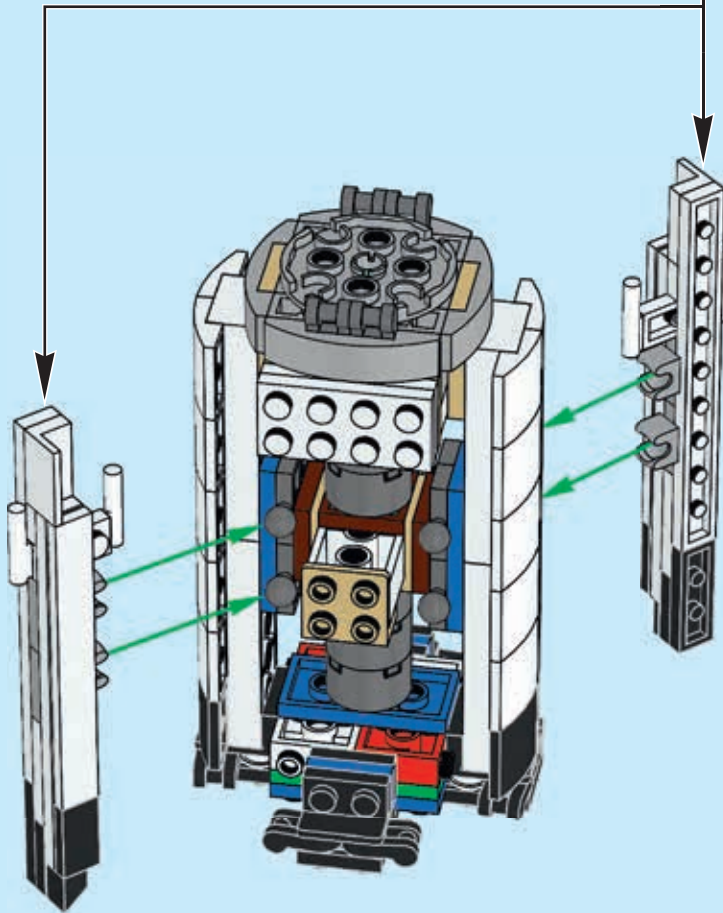

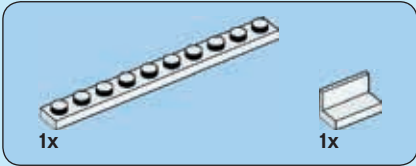

272

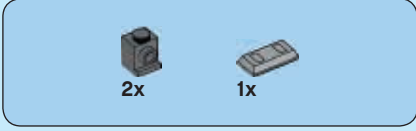
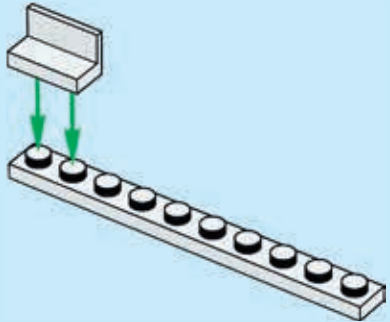

273

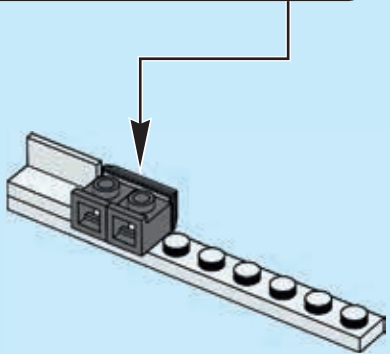
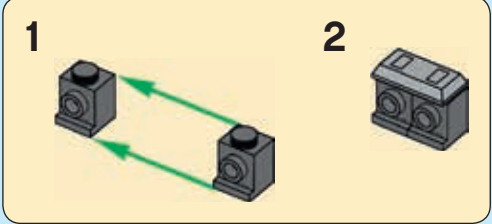

274

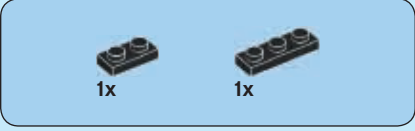
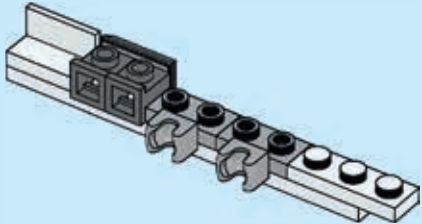

275

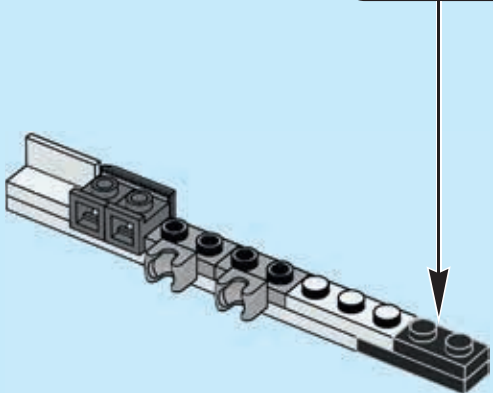
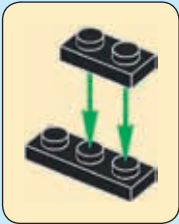



276

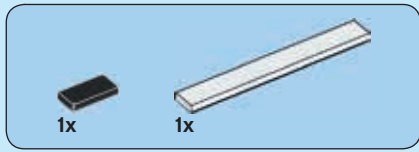
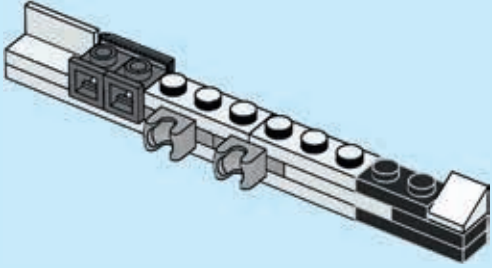

277

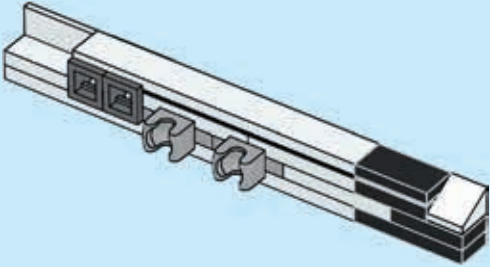

2x

278

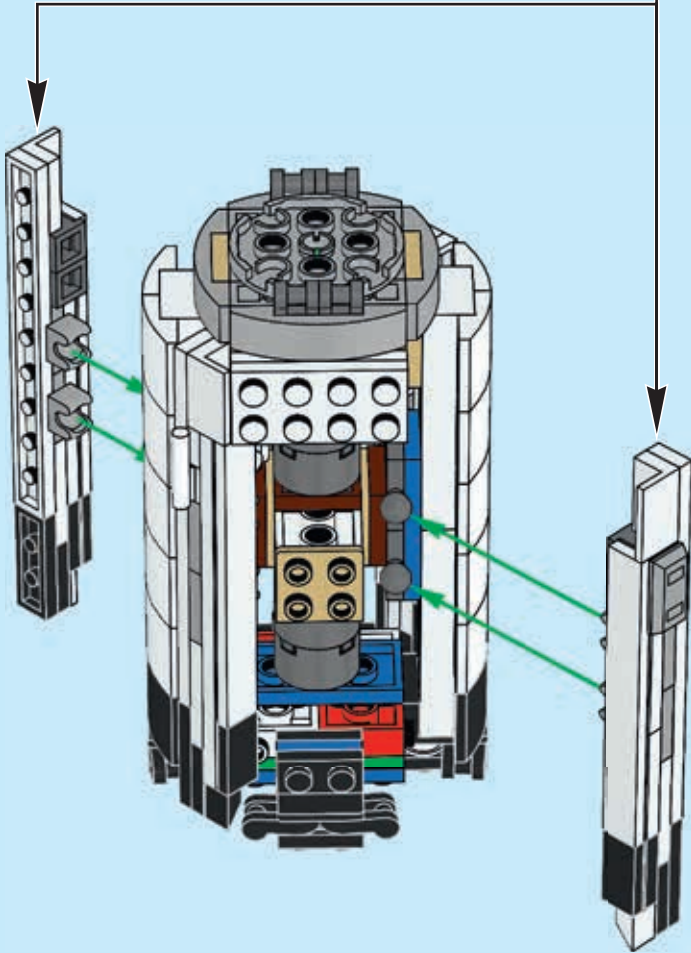

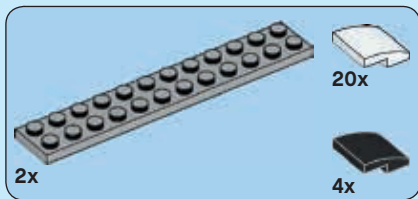

279

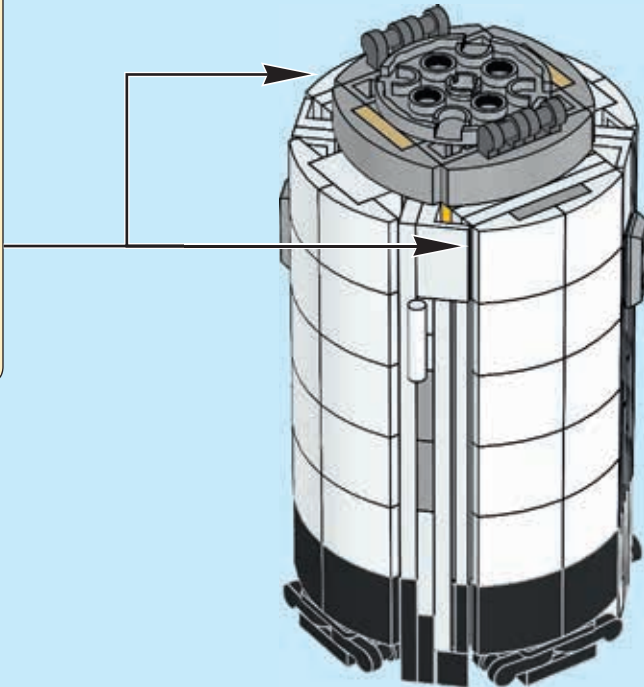
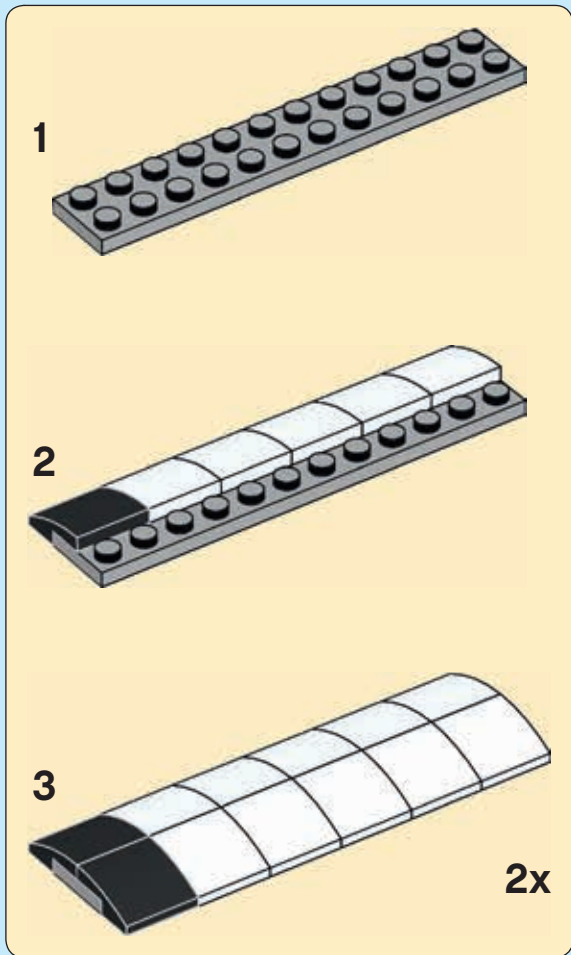



280

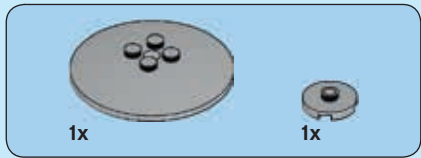
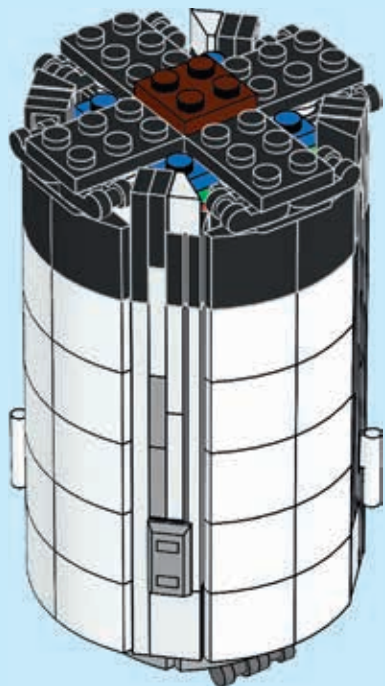
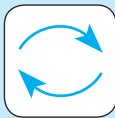

281

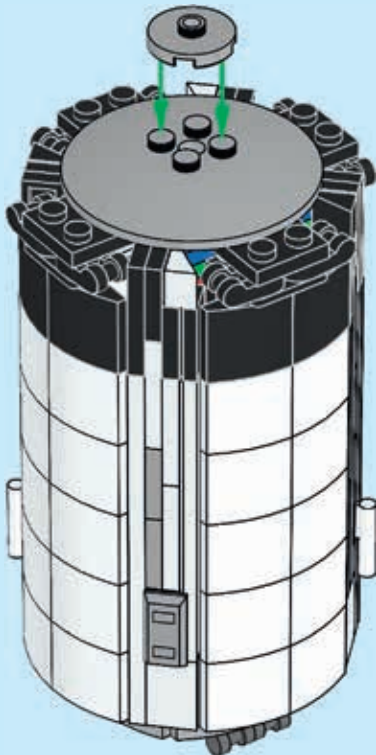

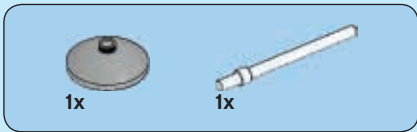

282

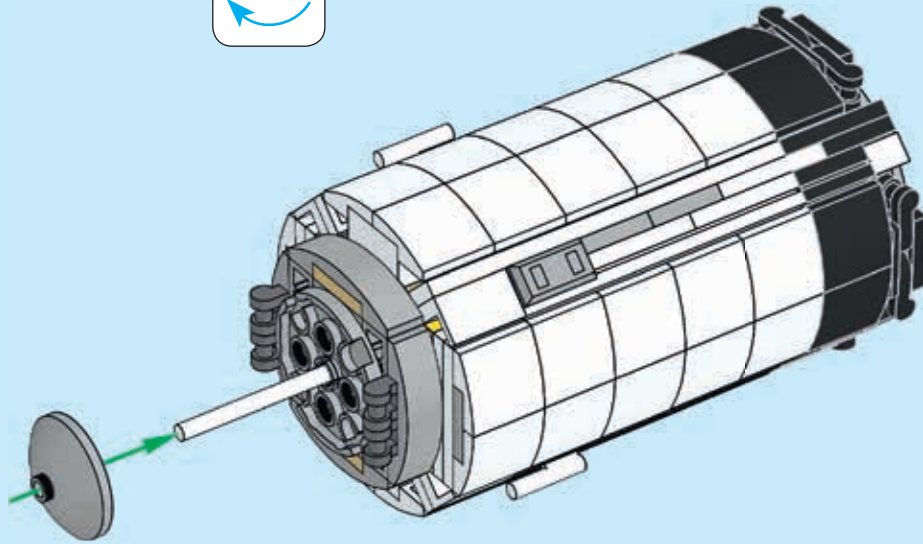
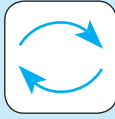

283

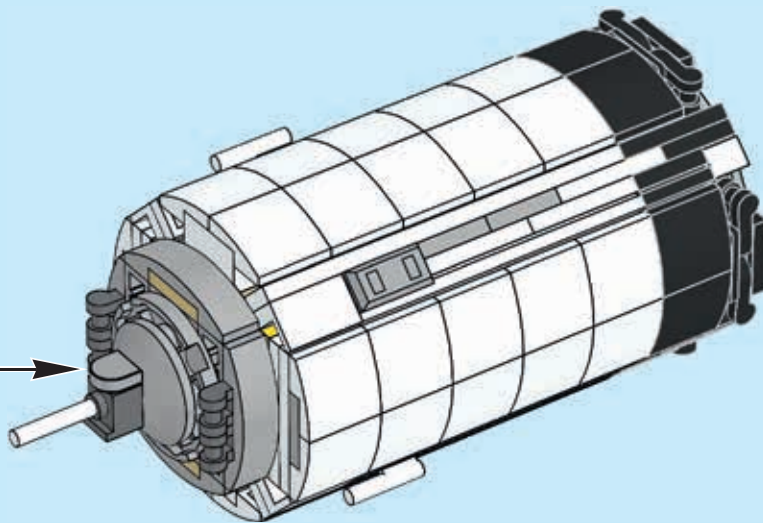
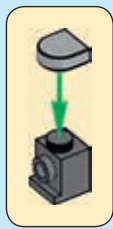



1x

284

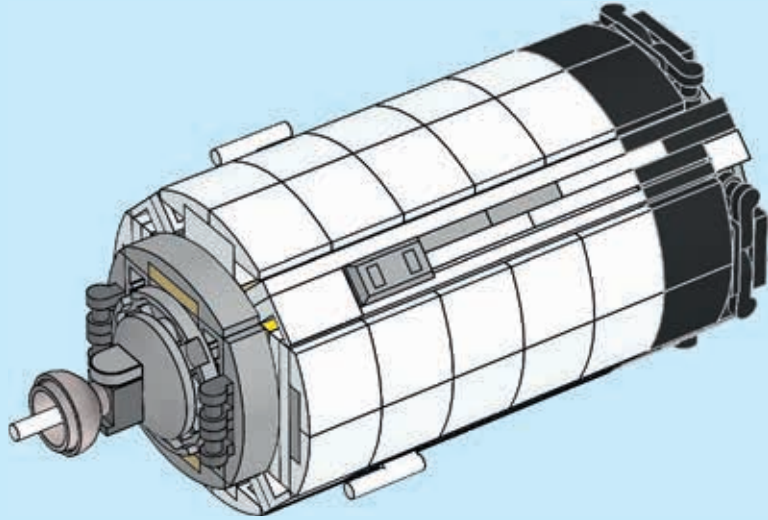

1x



1x

285

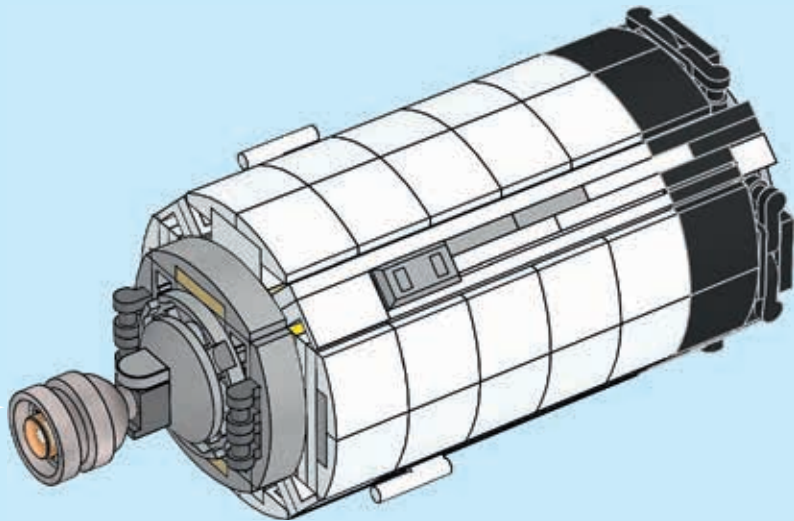

286

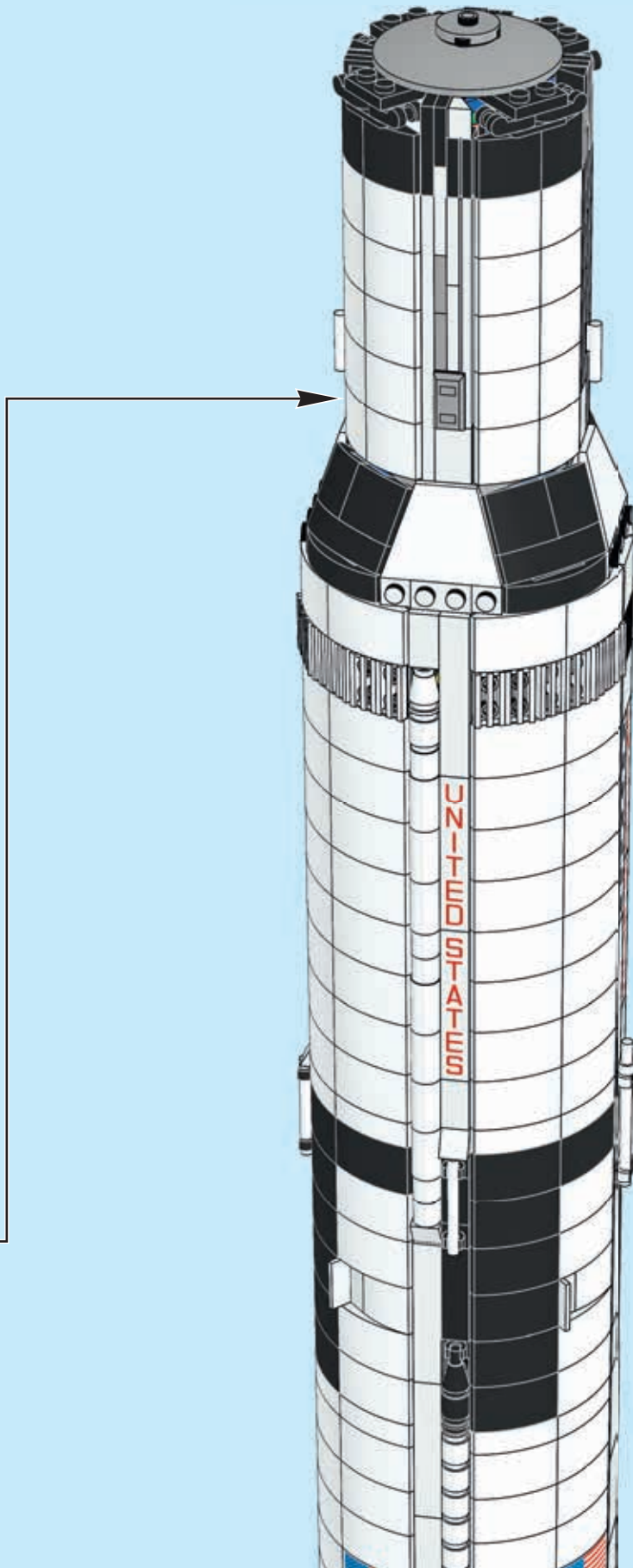



12



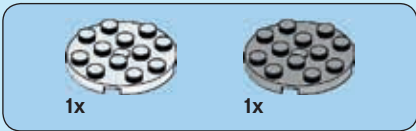
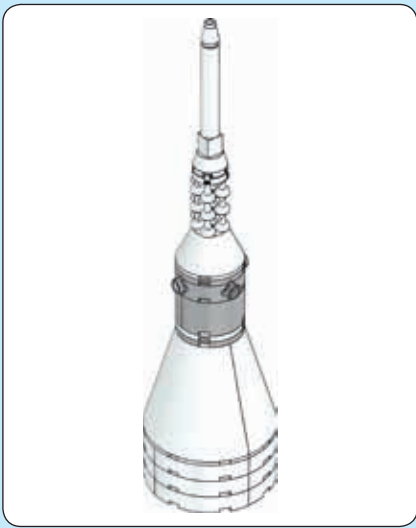

287

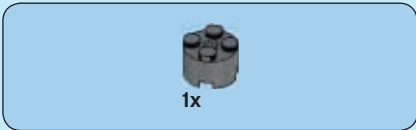

288

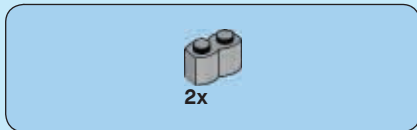
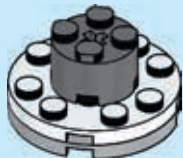

289



290

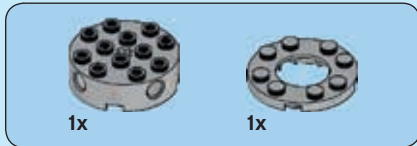

291



4x

292

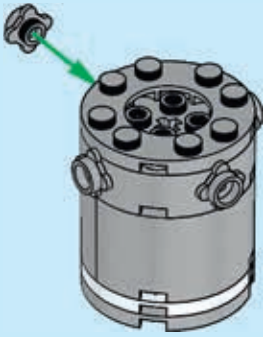

293

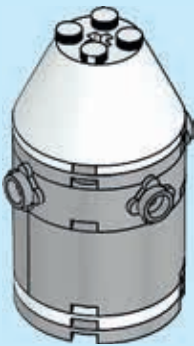

12x

294

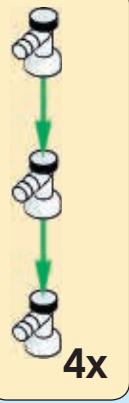
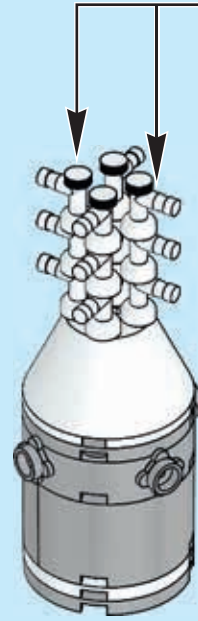

1x

295

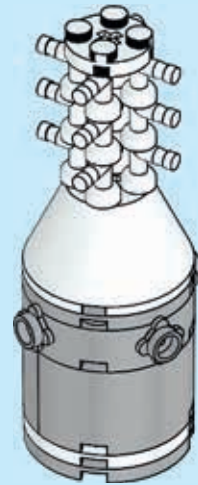

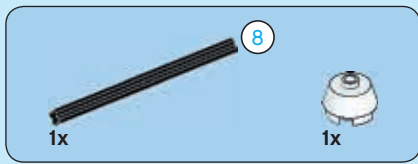

296

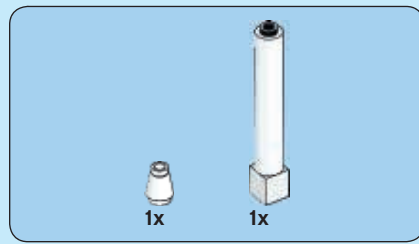
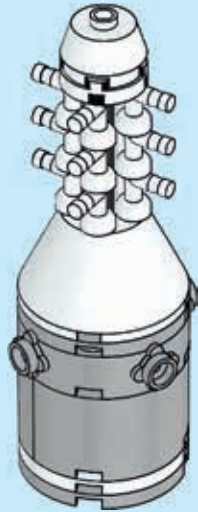
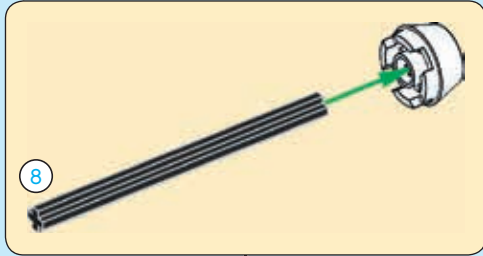

297

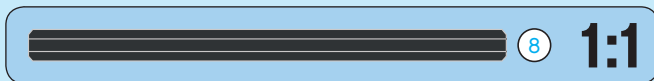
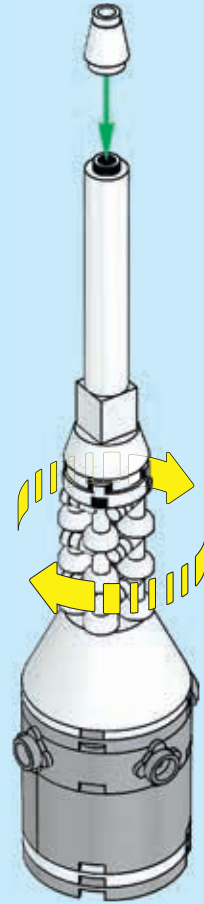

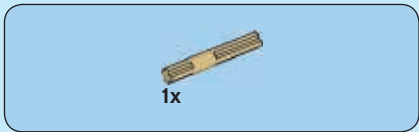

298

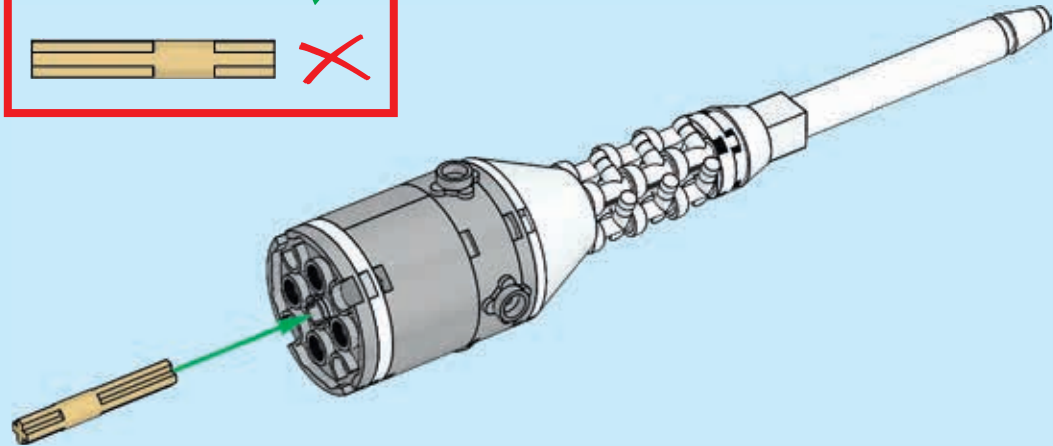
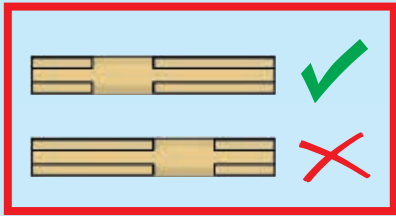

299

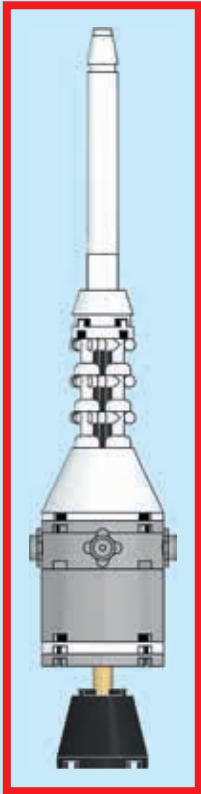
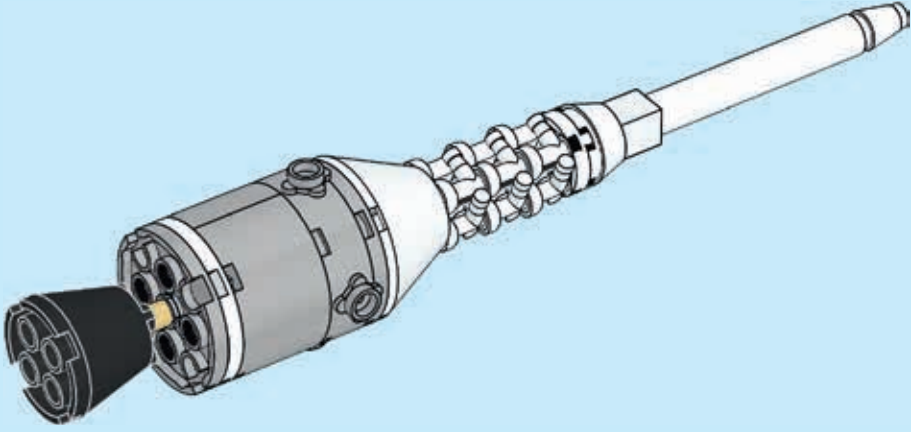

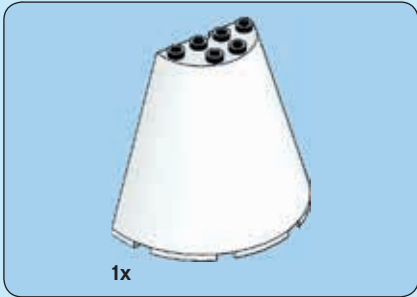

300

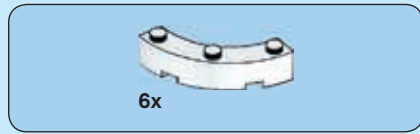

301

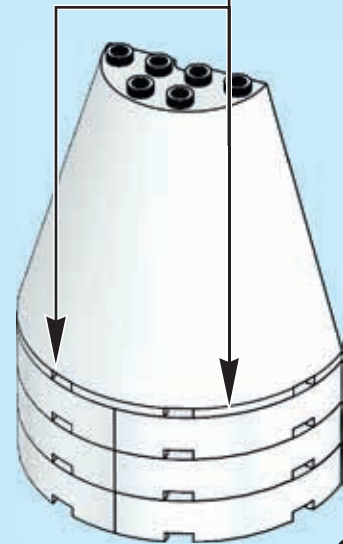
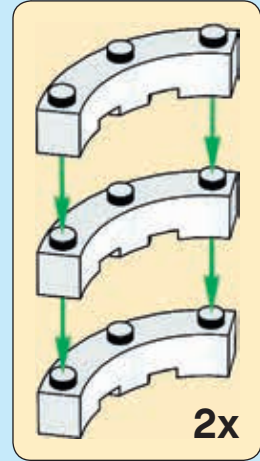

2x

302

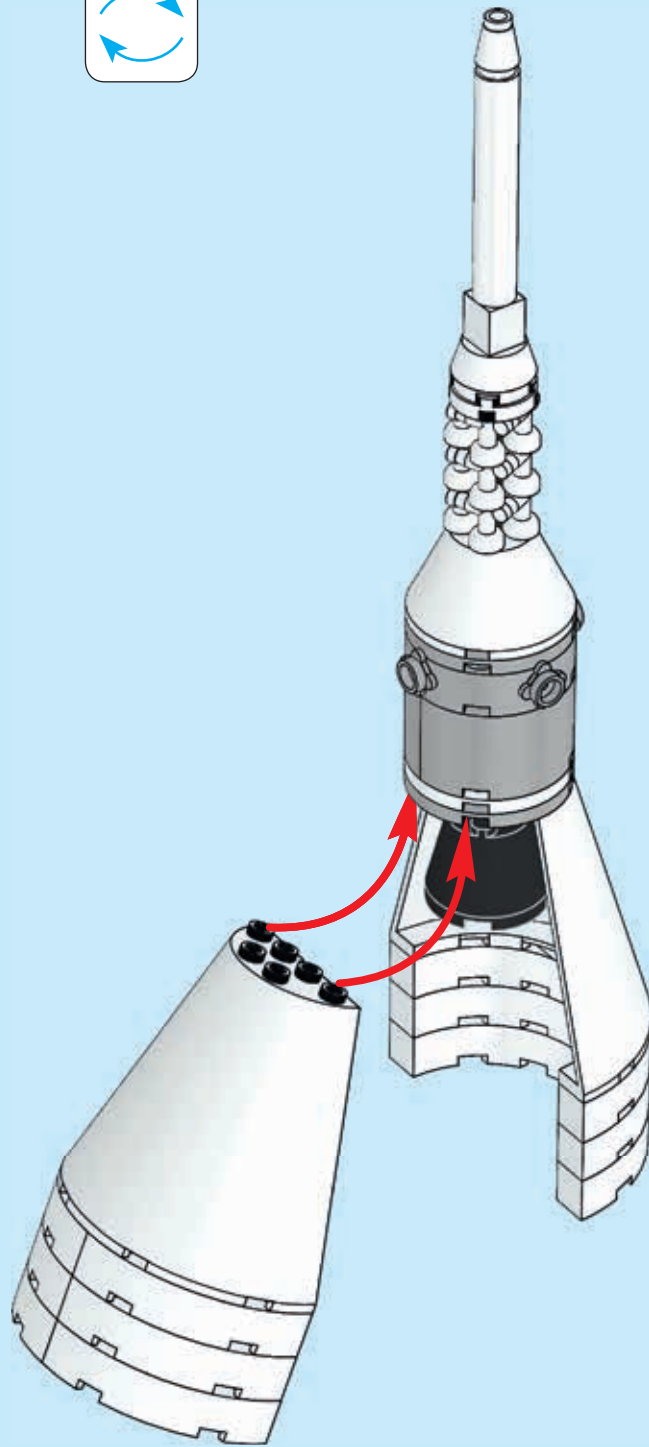
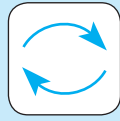

303

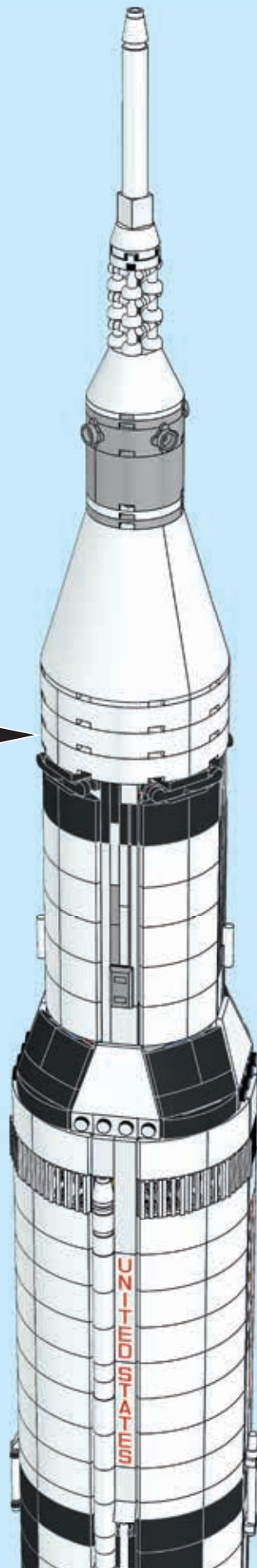

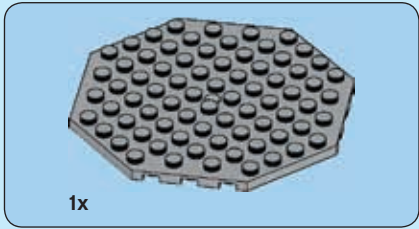
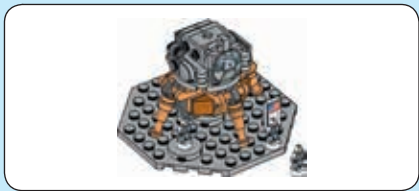

304

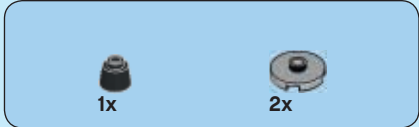
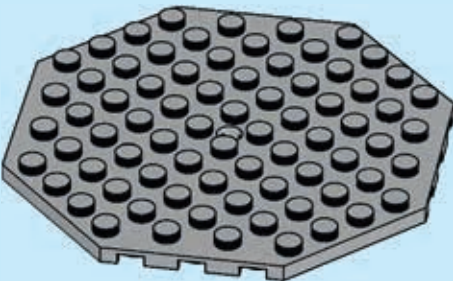

305

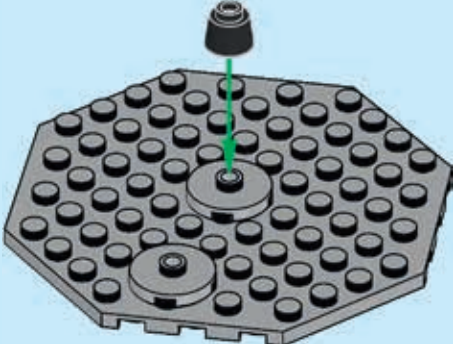



306

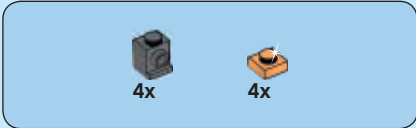

307

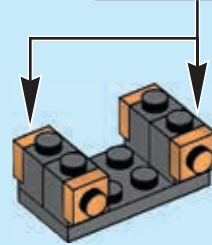
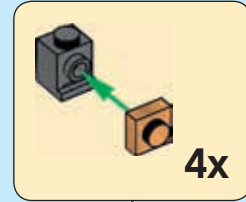

308

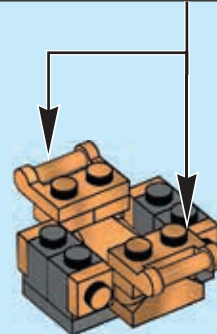
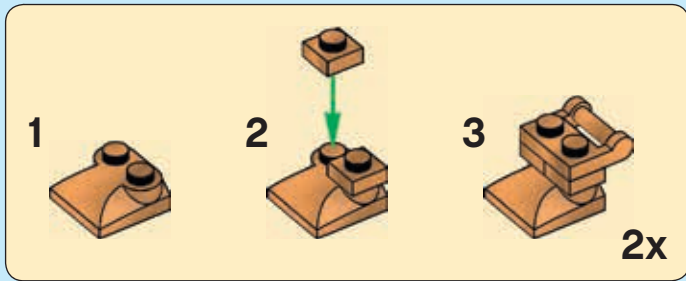



309

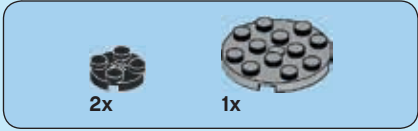
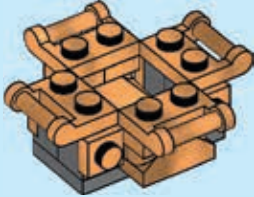

310

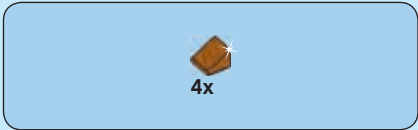
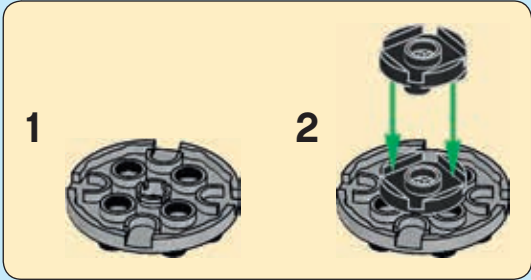

311



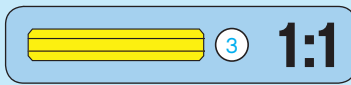
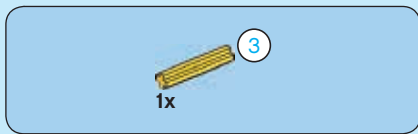

312



313

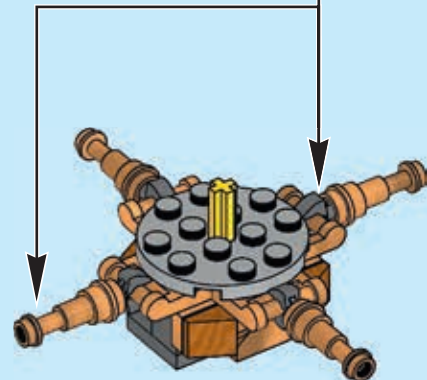
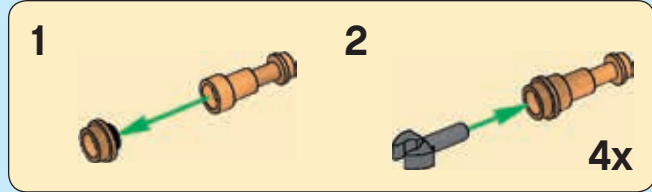



314

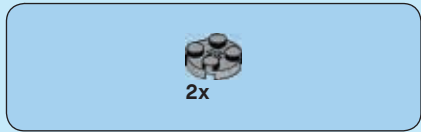
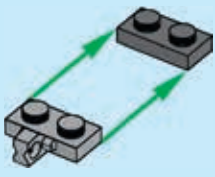

315

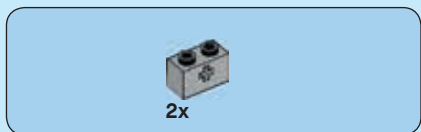
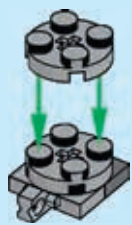

316

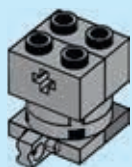

317

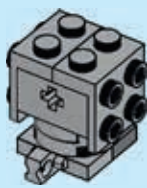

318

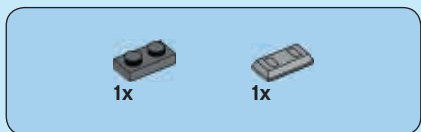
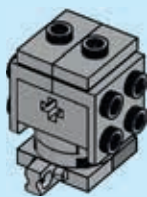

319

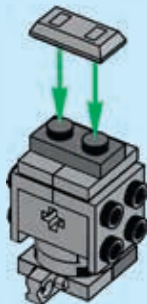



320

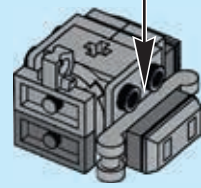
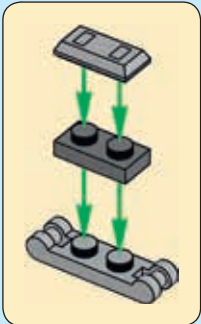

321

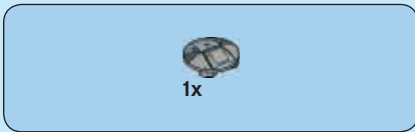
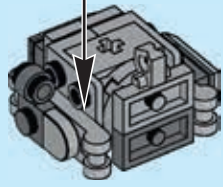
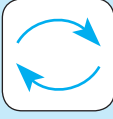
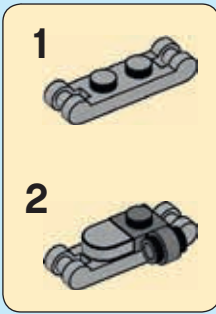

322

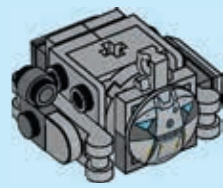

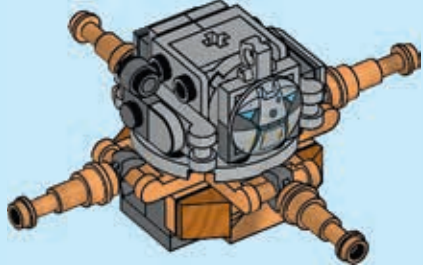

323

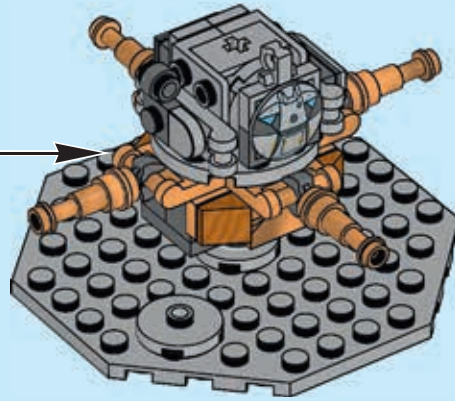

324



1x  3x 

325

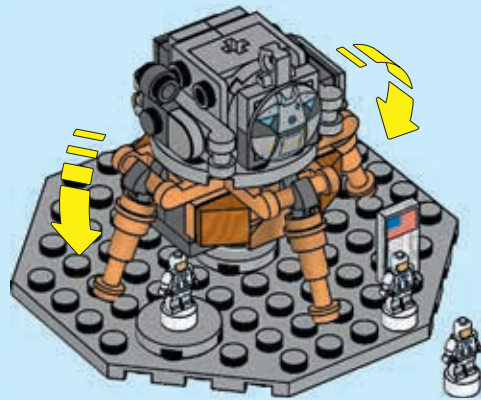

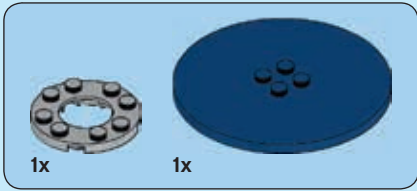
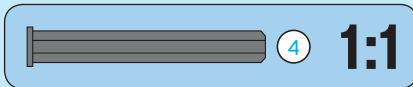

326

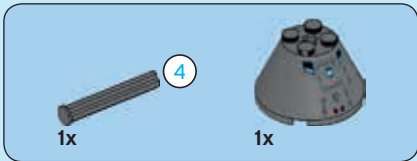

327

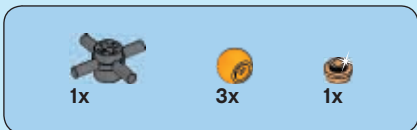
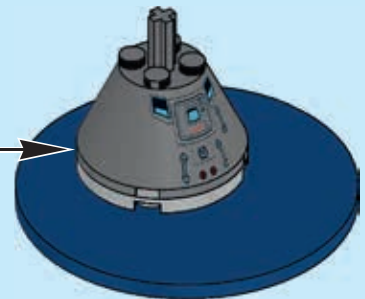
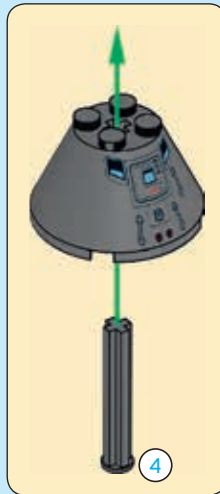

328

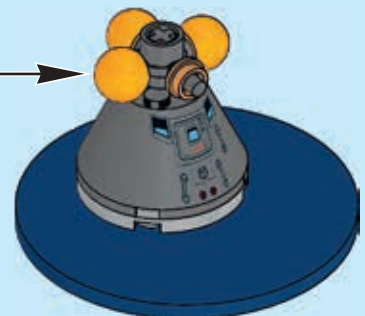



8x

329

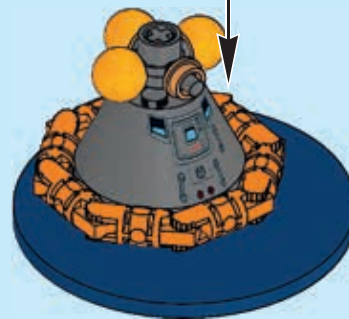
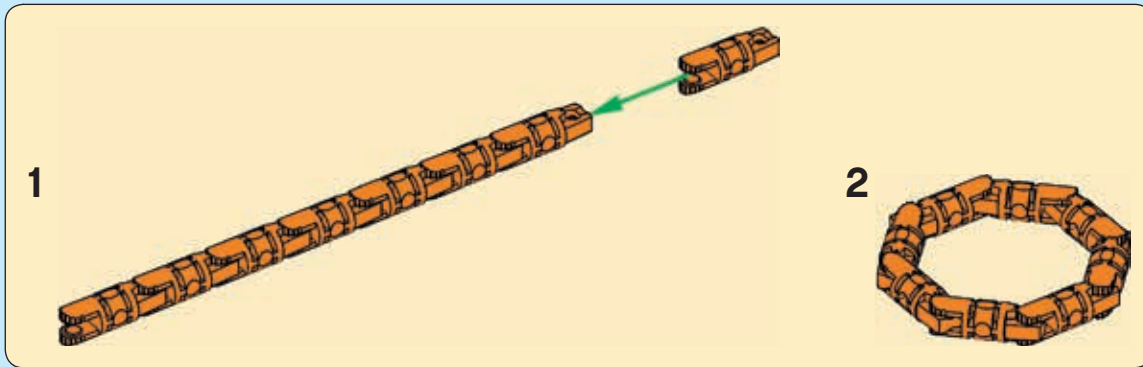

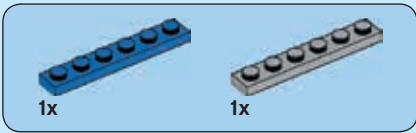
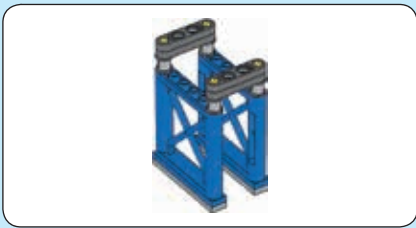

330

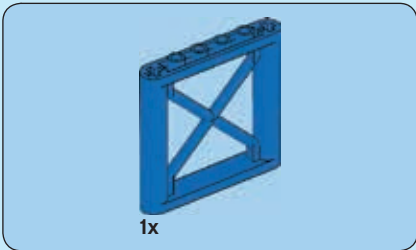
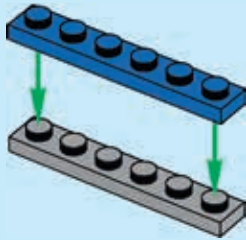

331



332

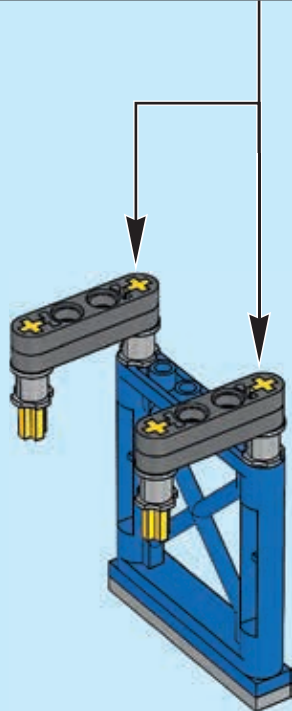
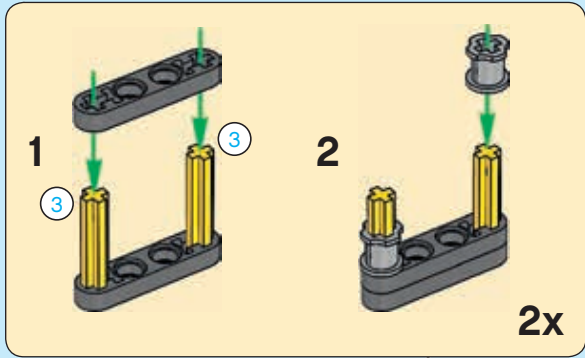
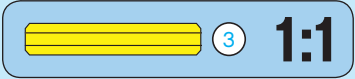

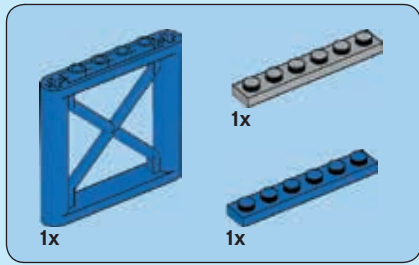

333

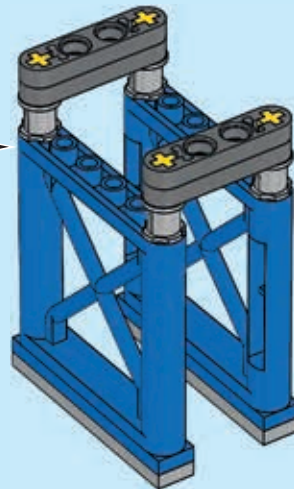
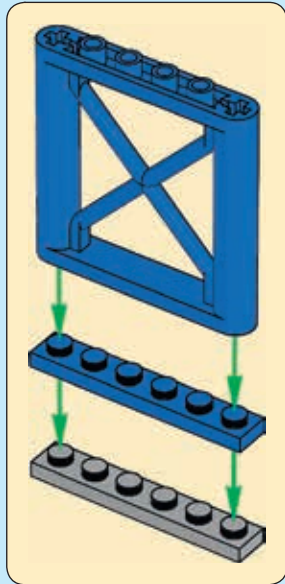

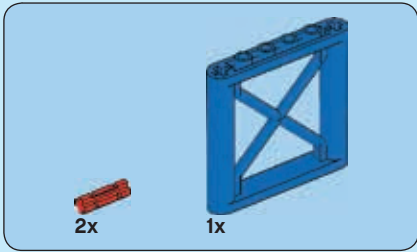

334

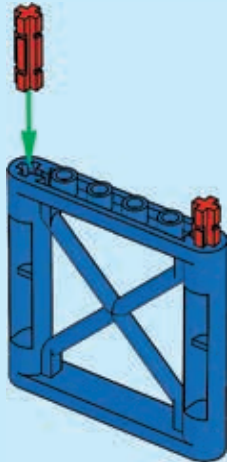

335

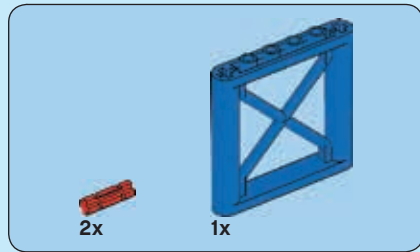
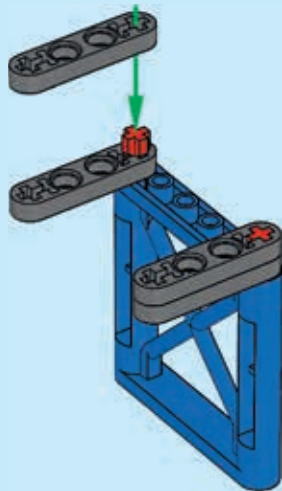

336

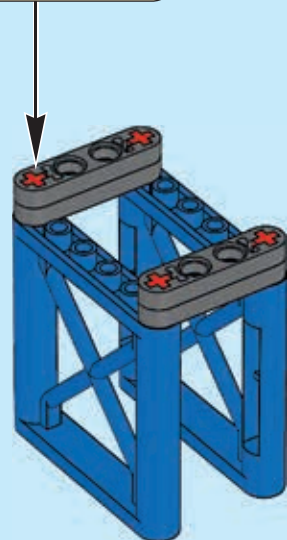
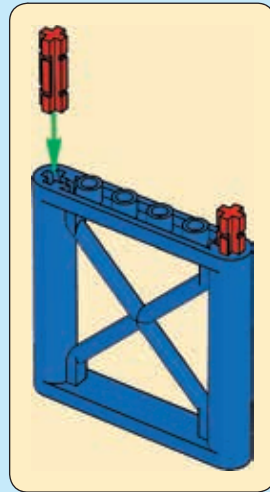

2x
175

337



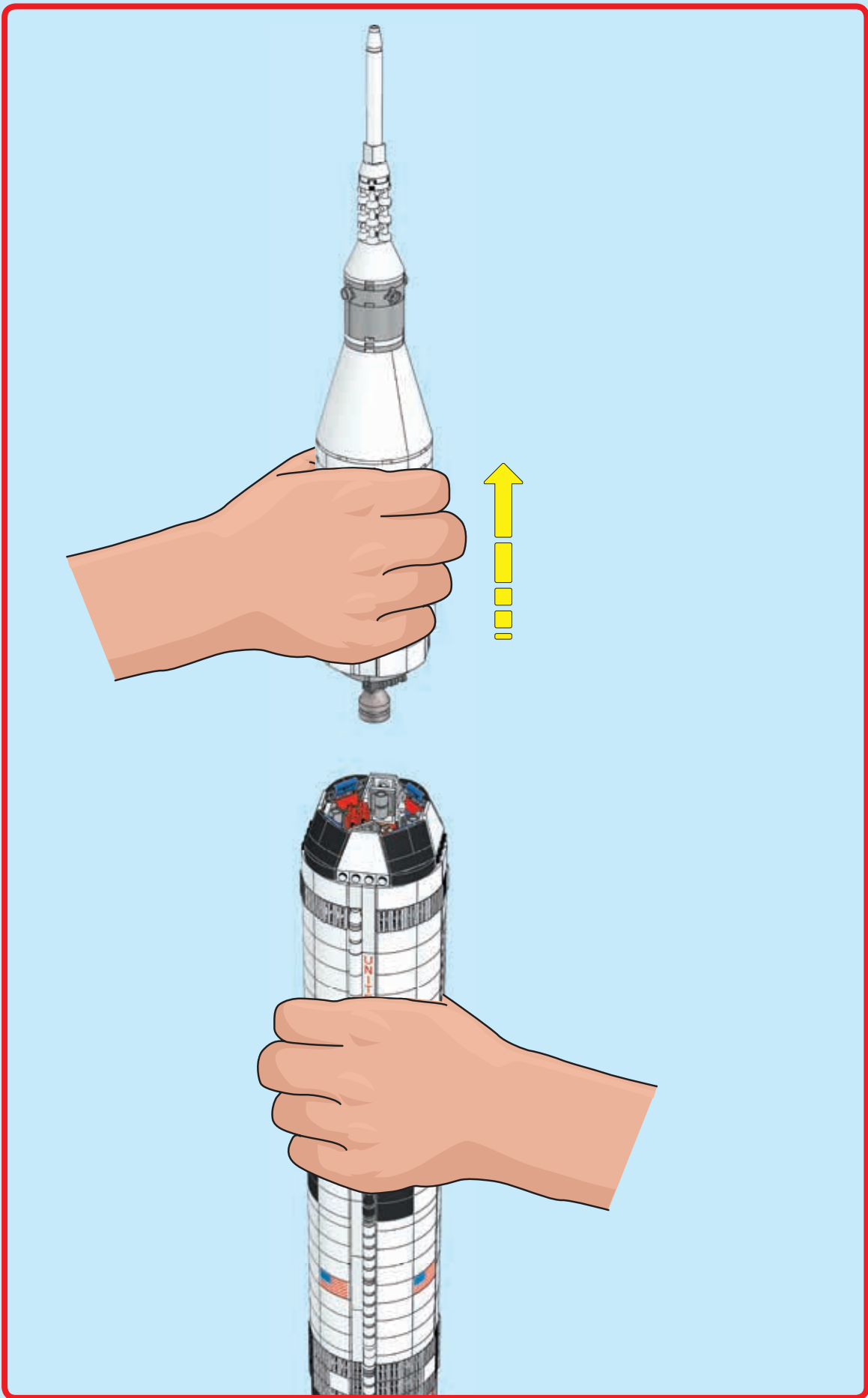

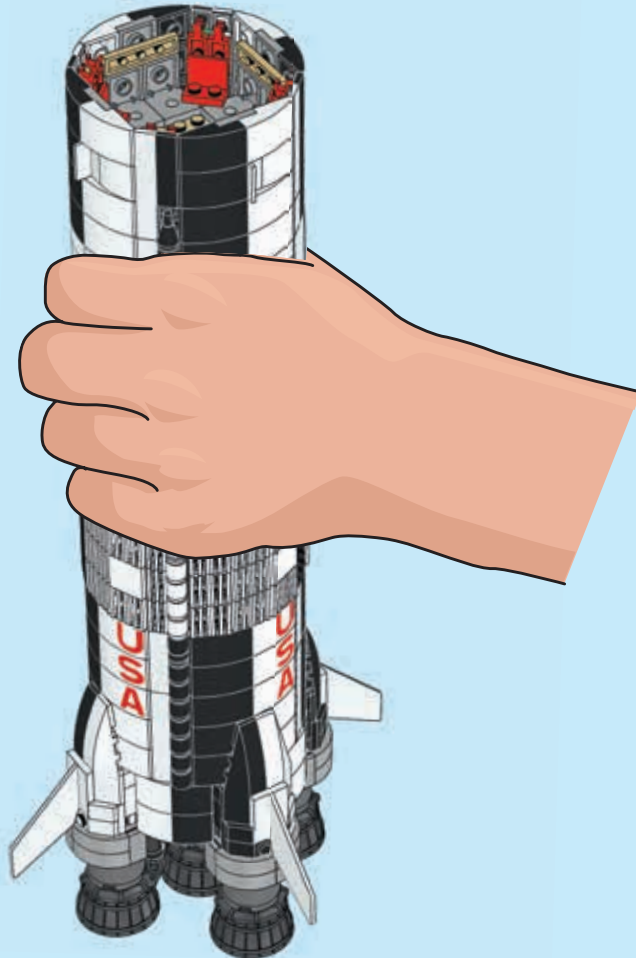
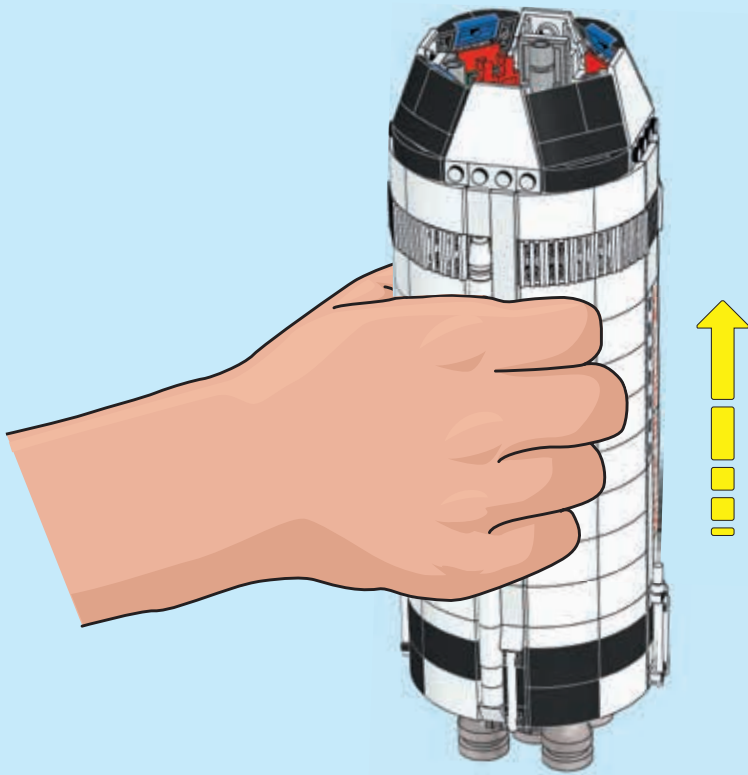

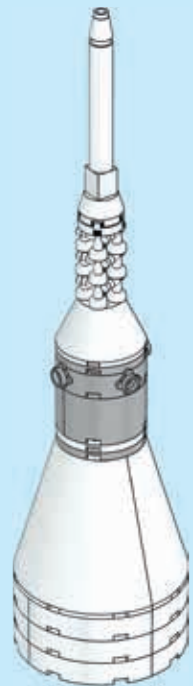
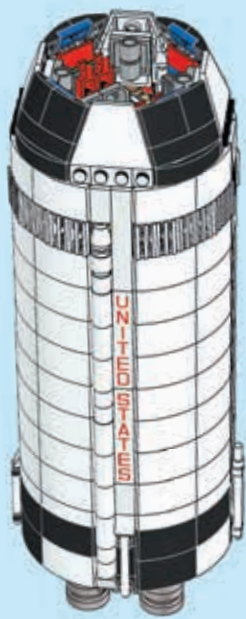
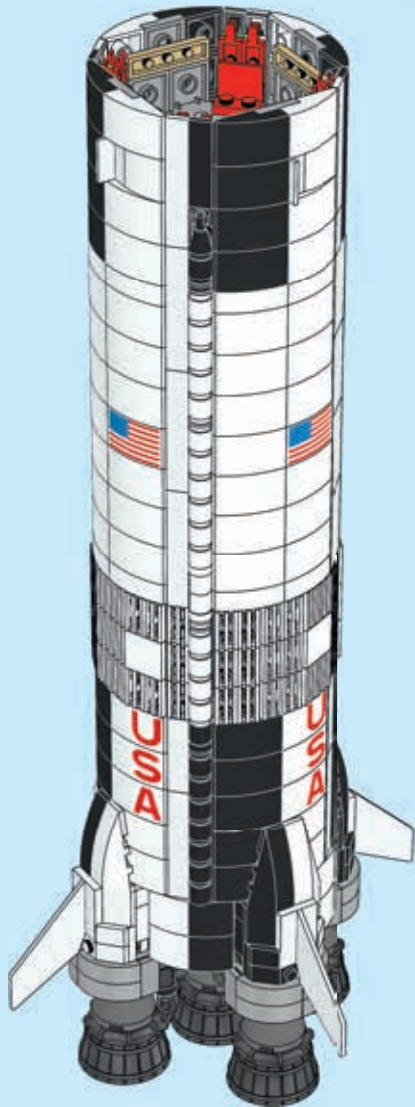

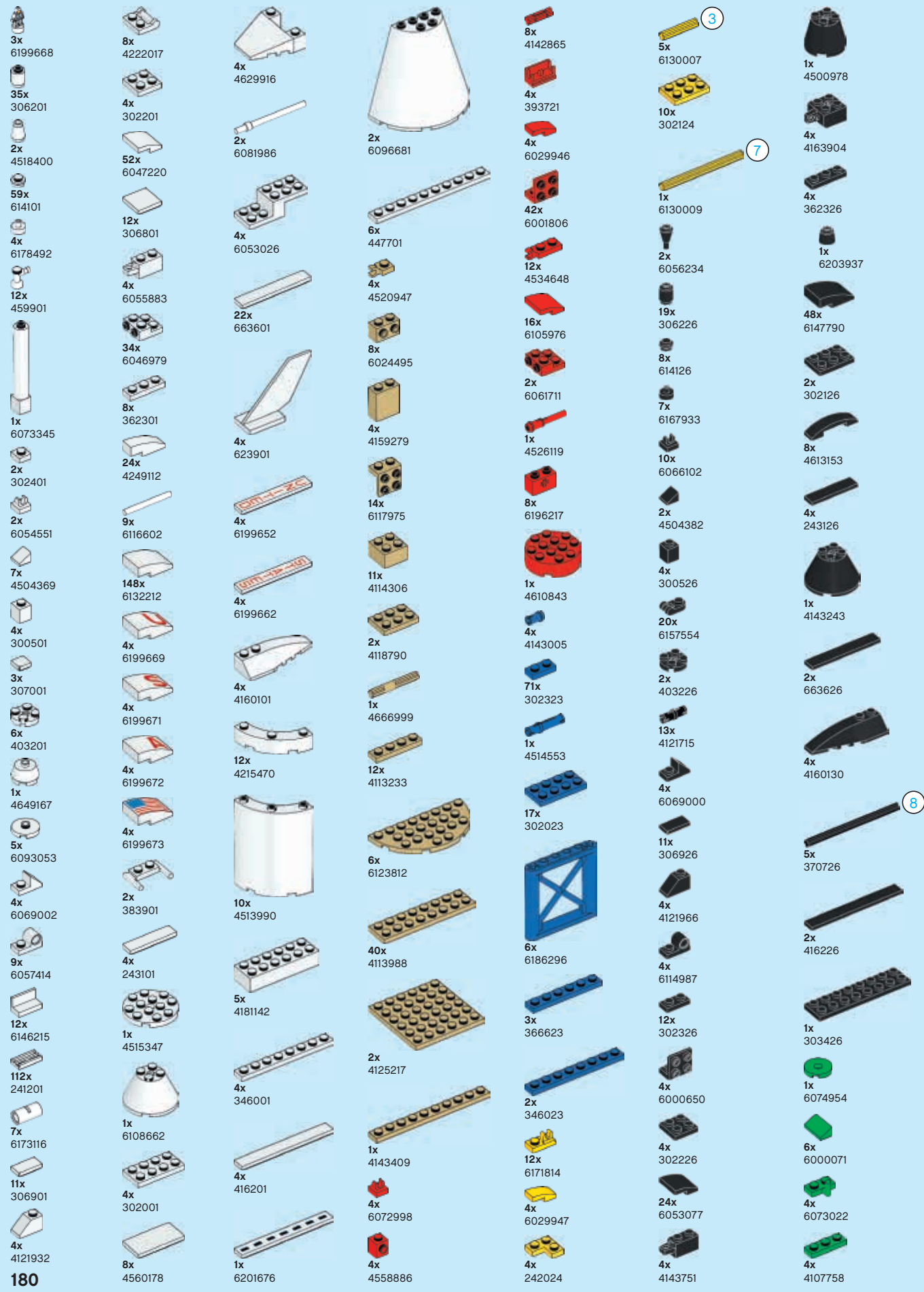

3x 6199668
 35x 306201
 2x 4518400
 59x 614101
 4x 6178492
 12x 459901
 1x 6073345
 2x 302401
 2x 6054551
 7x 4504369
 4x 300501
 3x 307001
 6x 403201
 1x 4649167
 5x 6093053
 4x 6069002
 9x 6057414
 12x 6146215
 112x 241201
 7x 6173116
 11x 306901
 4x 4121932

8x 4222017
 4x 302201
 52x 6047220
 12x 306801
 4x 6055883
 34x 6046979
 8x 362301
 24x 4249112
 9x 6116602
 148x 6132212
 4x 6199669
 4x 6199671
 4x 6199672
 4x 6199673
 2x 383901
 4x 243101
 1x 4515347
 1x 6108662
 4x 302001
 8x 4560178

4x 4629916
 2x 6081986
 4x 6053026
 22x 663601
 4x 623901
 4x 6199652
 4x 6199662
 4x 4160101
 12x 4215470
 10x 4513990
 5x 4181142
 4x 346001
 4x 416201
 1x 6201676

2x 6096681
 6x 447701
 4x 4520947
 8x 6024495
 4x 4159279
 14x 6117975
 11x 4114306
 2x 4118790
 1x 4666999
 12x 4113233
 6x 6123812
 40x 4113988
 2x 4125217
 1x 4143409
 4x 6072998
 4x 4558886

8x 4142865
 4x 393721
 4x 6029946
 42x 6001806
 12x 4534648
 16x 6105976
 2x 6061711
 1x 4526119
 8x 6196217
 1x 4610843
 4x 4143005
 71x 302323
 1x 4514553
 17x 302023
 6x 6186296
 3x 366623
 2x 346023
 12x 6171814
 4x 6029947
 4x 242024

5x 6130007
 10x 302124
 1x 6130009
 2x 6056234
 19x 306226
 8x 614126
 7x 6167933
 10x 6066102
 2x 4504382
 4x 300526
 20x 6157554
 2x 403226
 13x 4121715
 4x 6069000
 11x 306926
 4x 4121966
 4x 6114987
 12x 302326
 4x 6000650
 4x 302226
 24x 6053077
 4x 4143751

1x 4500978
 4x 4163904
 4x 362326
 1x 6203937
 48x 6147790
 2x 302126
 8x 4613153
 4x 243126
 1x 4143243
 2x 663626
 4x 4160130
 5x 370726
 2x 416226
 1x 303426
 1x 6074954
 6x 6000071
 4x 6073022
 4x 4107758

3

7

8



3x
4243821



1x
6199664



8x
6200047



1x
4654448



1x
6200046



5x
4222960



5x
4646865



5x
6185735



3x
6071608



16x
4216695



2x
6151688



4x
6182167



4x
4211622



4x
4211475



1x
6199828



8x
4550325



4x
6183782



1x
4211814



62x
6066097



8x
6043656



8x
4211414



4x
6134378



12x
4211440



10x
6123809



2x
6117967



40x
4654582



4x
4563045



4x
4211376



4x
4211397



4x
4211410



4x
4211881



10x
6019212



1x
6070564



16x
4625619



2x
6206249



2x
6093058



2x
6134782



4x
4622803



2x
4211445



4x
4211409



4x
4515351



2x
6028015



2x
4211527



4x
4211385



2x
4211352



4x
4211438



1x
4211796



22x
4211452



2x
4211425



16x
4211404



10x
4211462



1x
6034493



2x
4211360



4x
4289542



9x
4211044



9x
4249139



1x
4632574



8x
6039479



3x
4211063



5x
4210698



6x
6117972



40x
6000606



1x
4222192



4x
4218696



8x
4210884



12x
4521187



5x
6201630



12x
4210749



4x
6099909



1x
6083620



1x
6199823



26x
4211065



10x
4221749



2x
6141856



4x
4211122



12x
6000970



21x
6141499



8x
6069887



8x
4538126



4x
4585493



2x
4286597



6x
6102756



6x
6102594



5x
6008484



4x
6200049



5x
6197967



5x
6197966



4x
6191668

4



Customer Service

Kundenservice

Service Consommateurs

Servicio Al Consumidor

LEGO.com/service or dial



: 00800 5346 5555

: 1-800-422-5346



IDEAS

LEGO® REVIEW
LEGO® PRÜFUNG
EXAMEN PAR LEGO®
REVIEW LEGO®
REVISIÓN DE LEGO®
AVALIAÇÃO LEGO®
LEGO® VÉLEMÉNYEZÉS
乐高®评论

SHARE YOUR IDEA
TEILE DEINE IDEE
PARTAGE TON IDÉE
CONDIVIDI LA TUA IDEA
COMPARTE TU IDEA
PARTILHA A TUA IDEIA
TEDD KÖZZÉ AZ ÖTLETED
分享您的观点

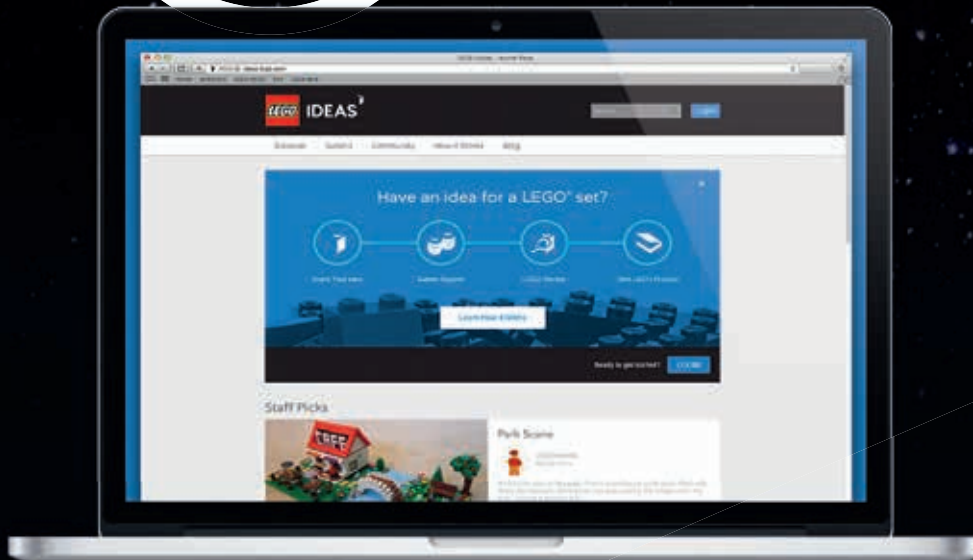
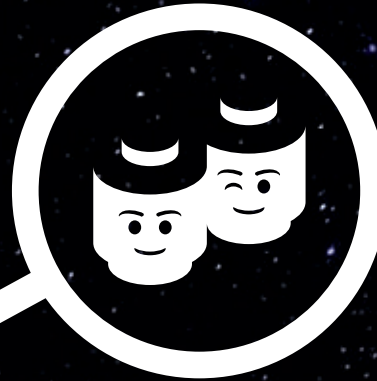

GATHER SUPPORT
HOL' DIR UNTERSTÜTZUNG
RASSEMBLE DES VOTES
CHIEDI DI ESSERE SUPPORTATO
GANA APOYOS
OBTÉM APOIO
SZEREZZ TÁMOGATÁST
获得更多支持

NEW LEGO® PRODUCT
NEUES LEGO® PRODUKT
NOUVEAU PRODUIT LEGO®
NUOVO PRODOTTO LEGO®
NUEVO PRODUCTO LEGO®
NOVO PRODUTO LEGO®
ÚJ LEGO® TERMÉK
新的乐高®产品



[LEGO.COM/IDEAS](https://www.lego.com/ideas)



IDEAS

Do you like this LEGO® Ideas set?

The LEGO® Group would like your opinion on the new product you have just purchased. Your feedback will help shape the future development of this product series. Please visit:

LEGO.com/productsurvey



By completing our short feedback survey, you will be automatically entered into a drawing to win a LEGO® prize. See website for official rules and details. Open to all countries where not prohibited.