

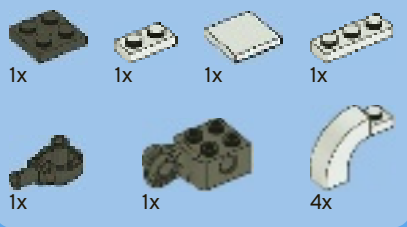

SHUTTLE ADVENTURE
LA NAVETTE AVENTURE

10213





56

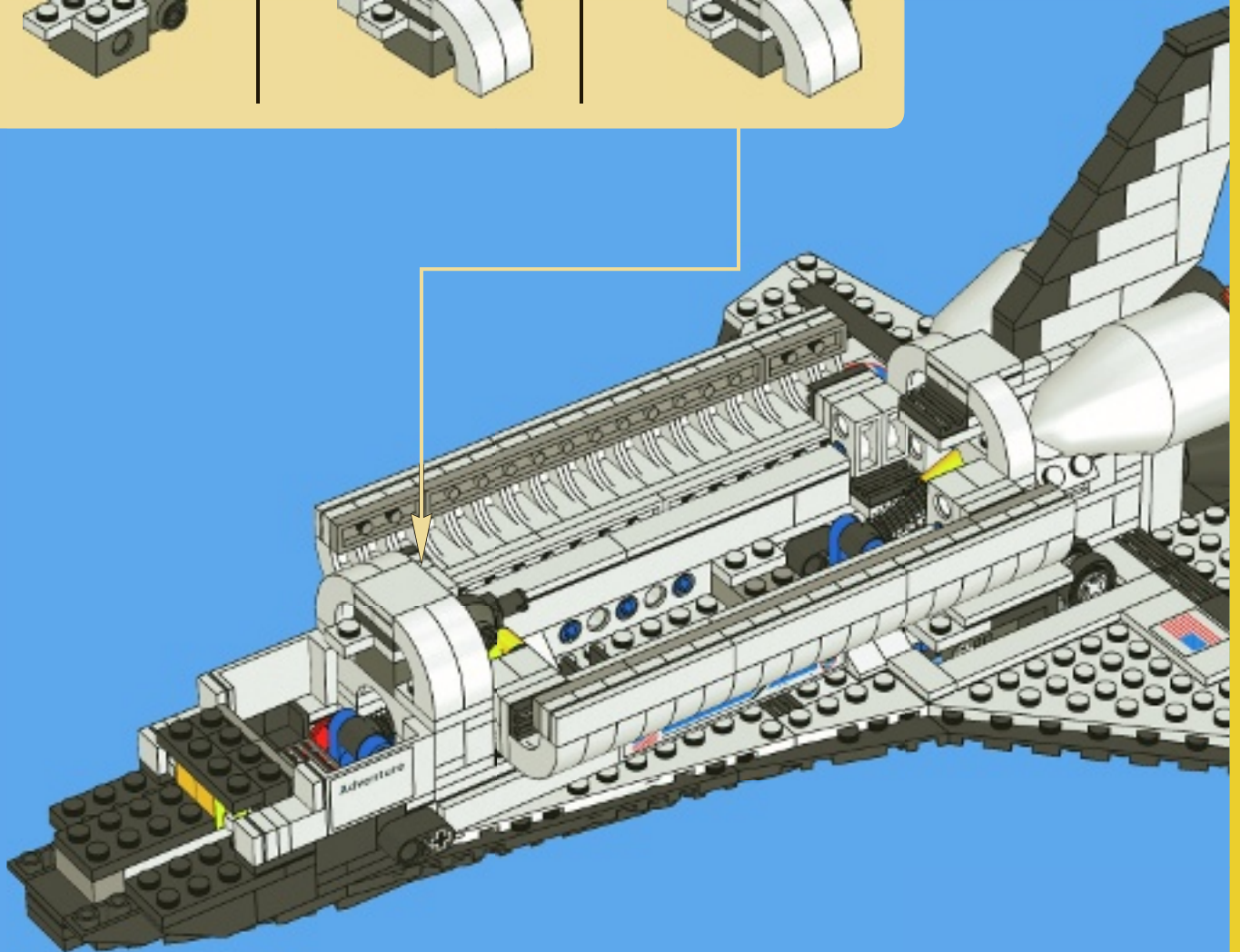
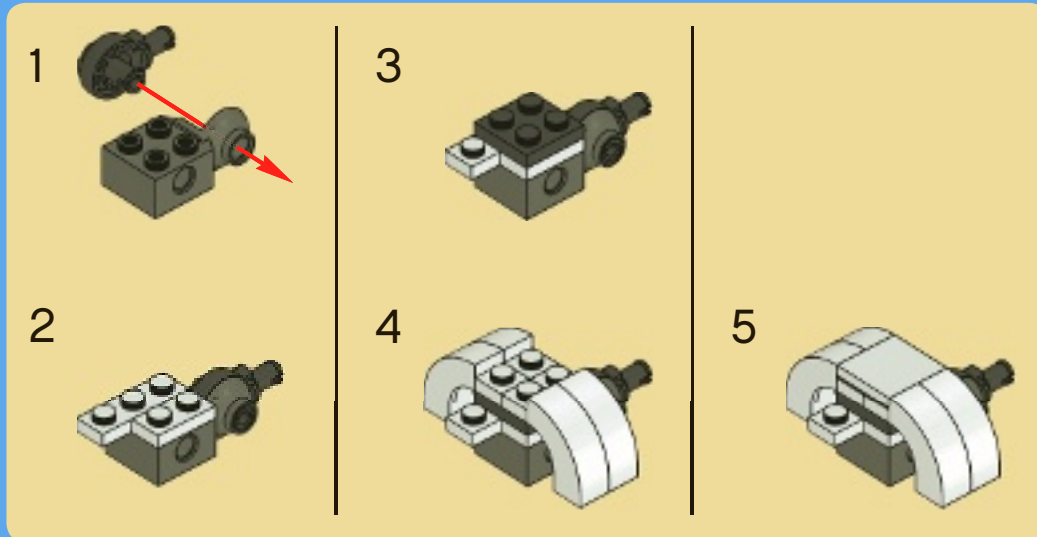



1x



4x

57

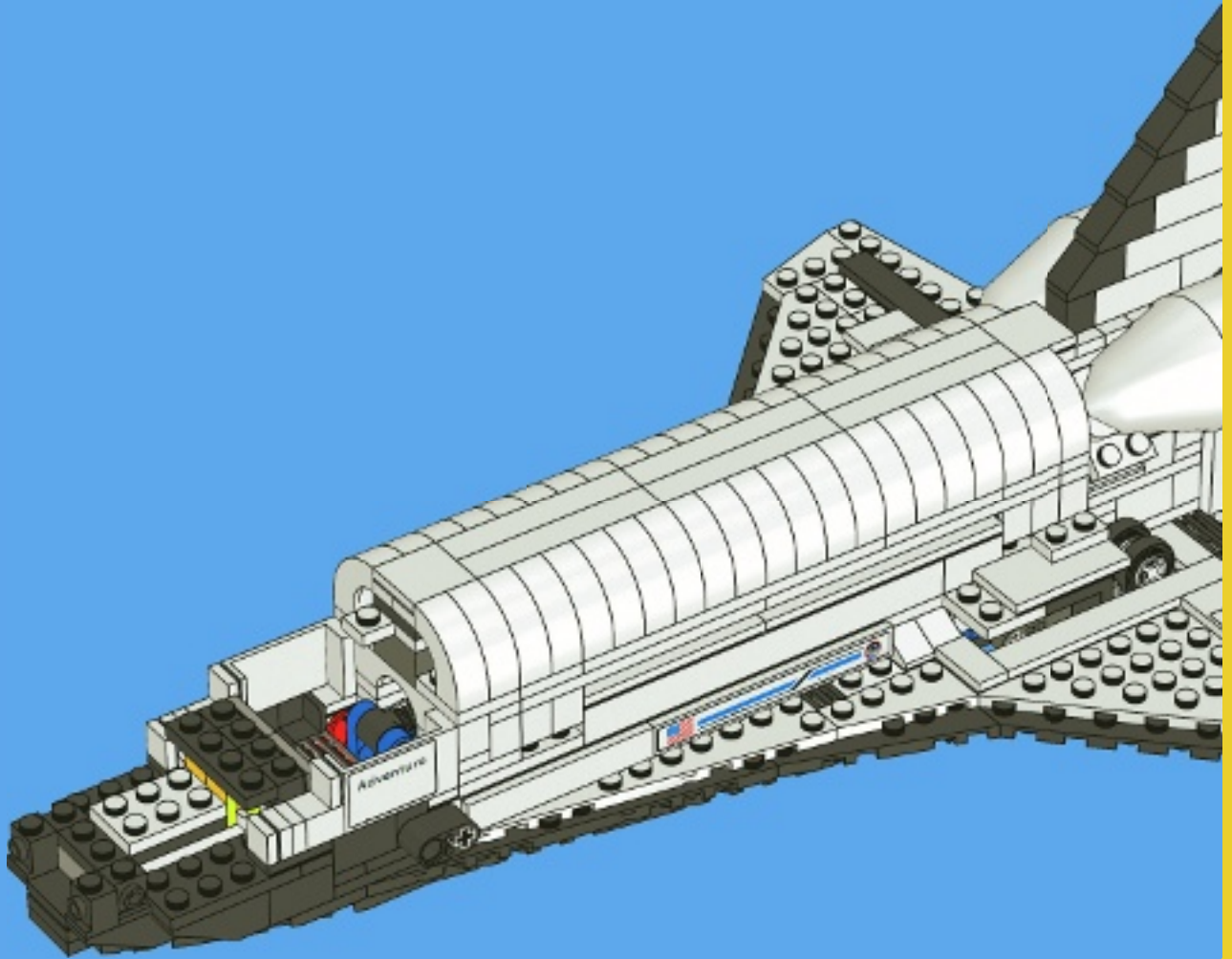

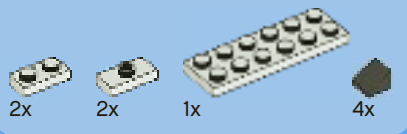

58

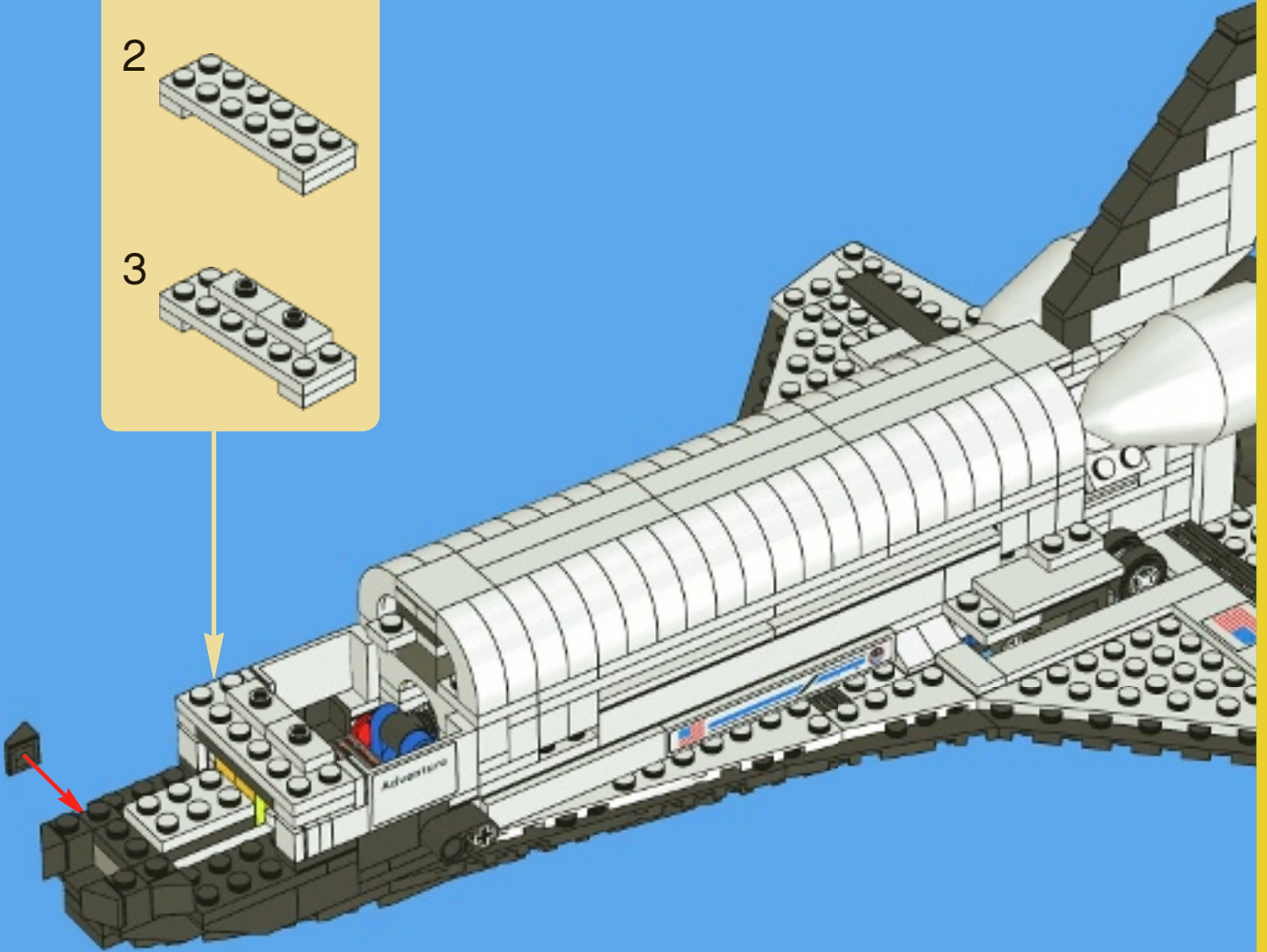
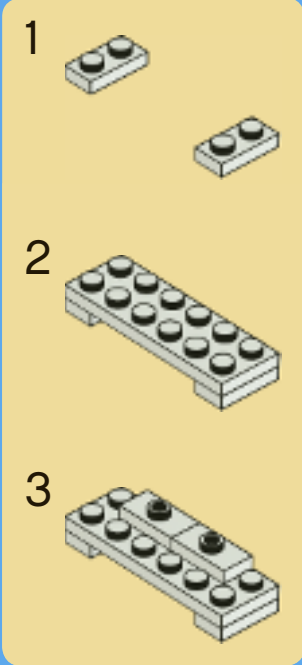



2x



2x

59

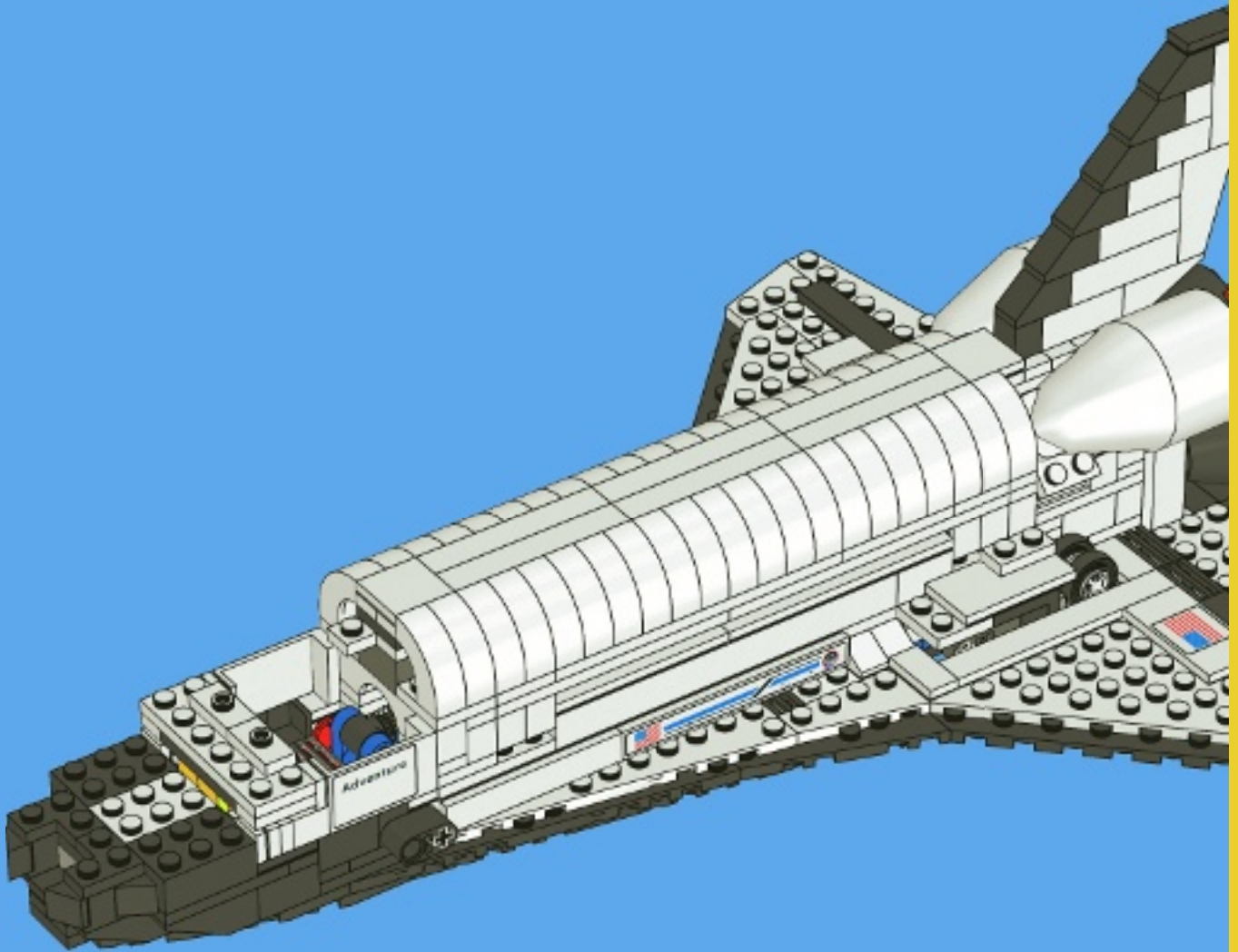



2x



2x



2x

60

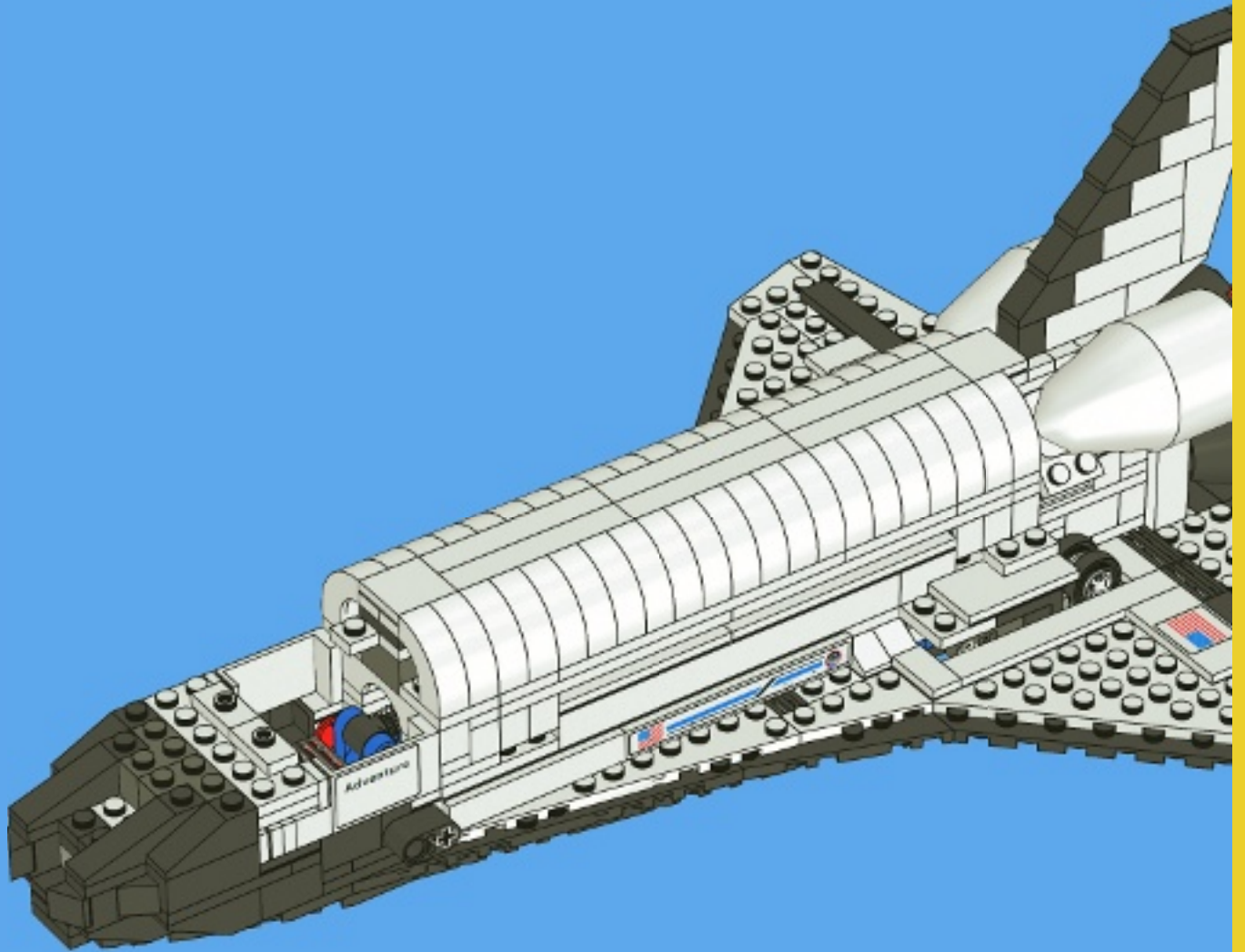

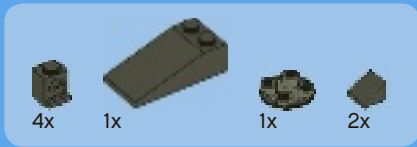

61

- 1
- 2
- 3
- 4

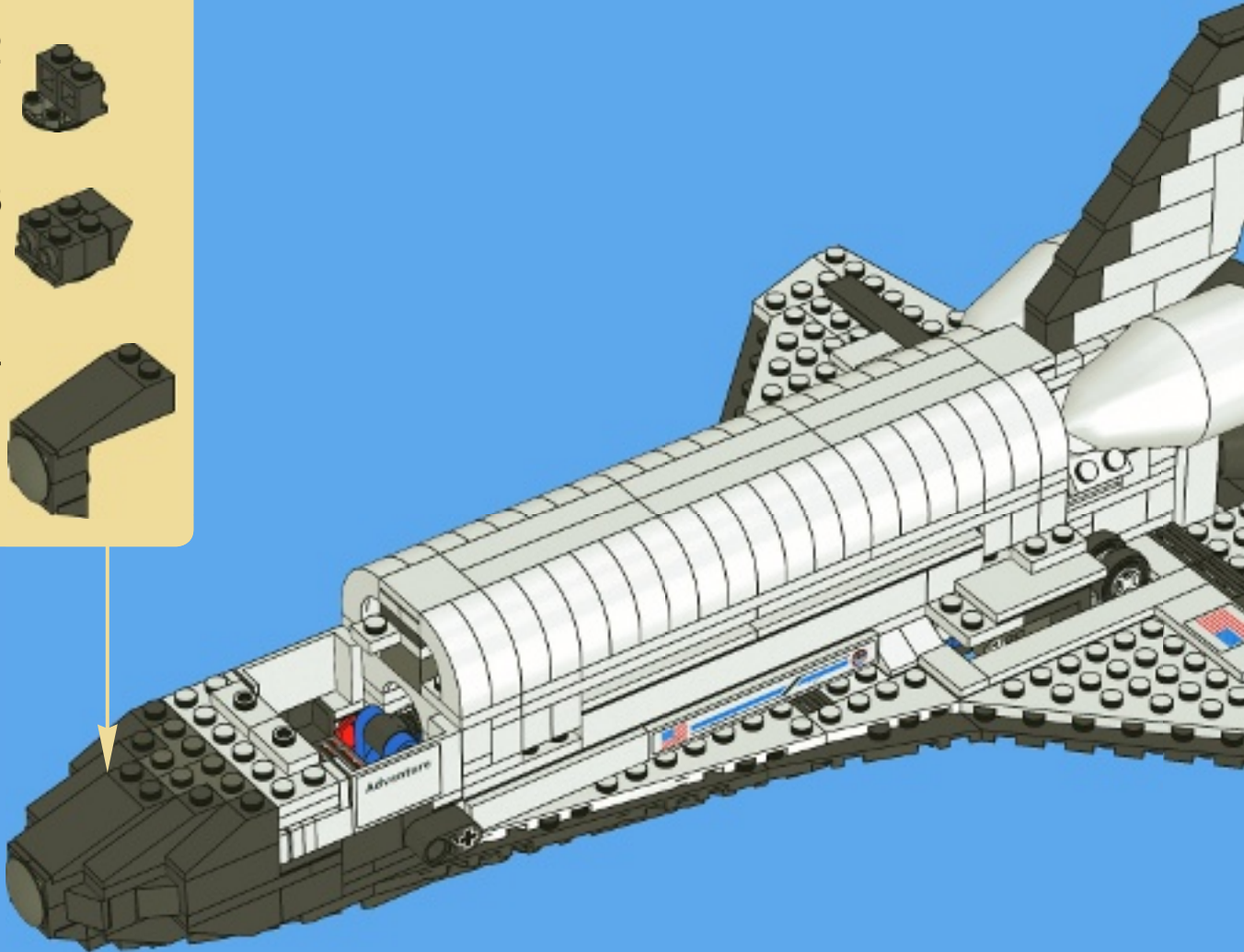



4x



1x

62

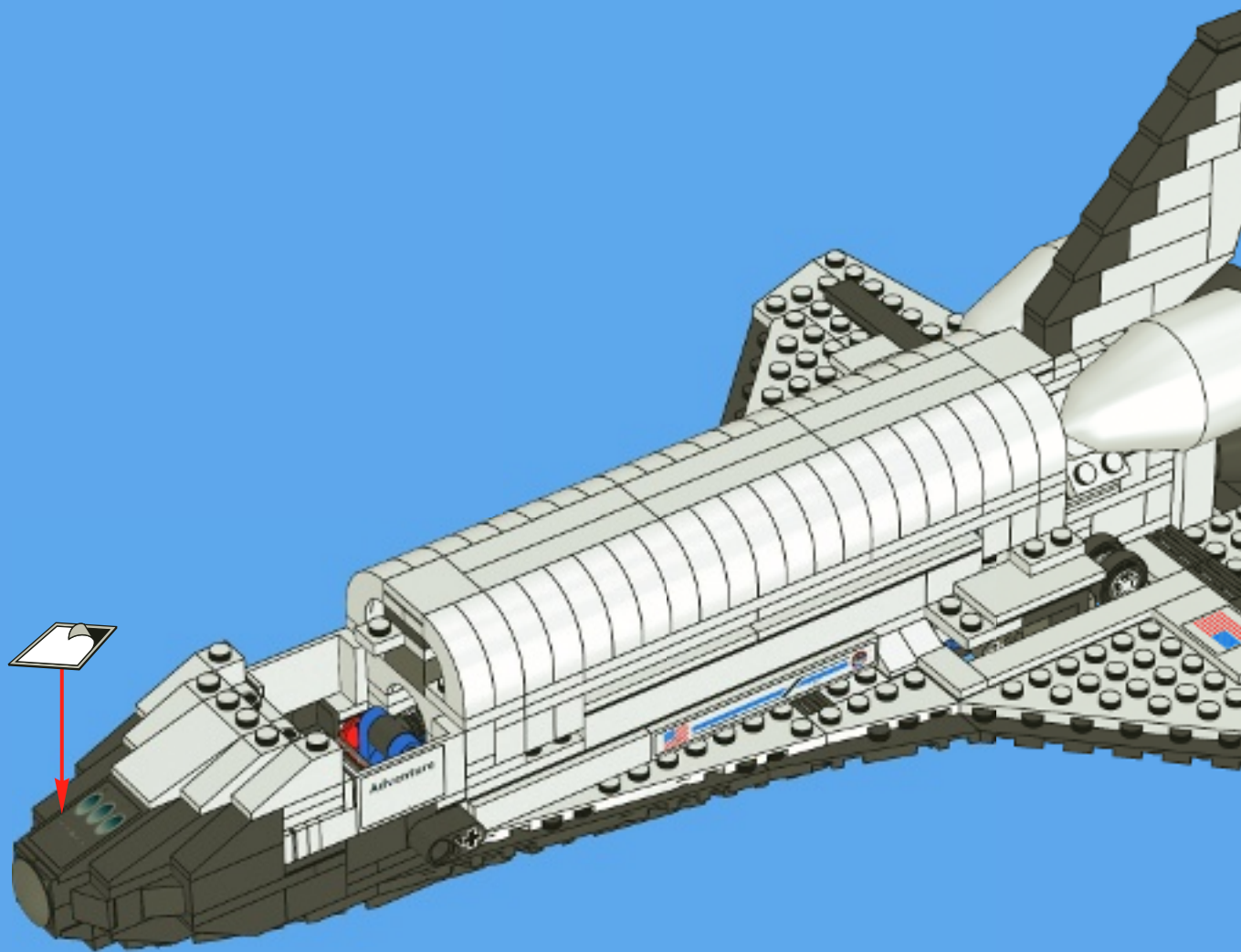



6x

63

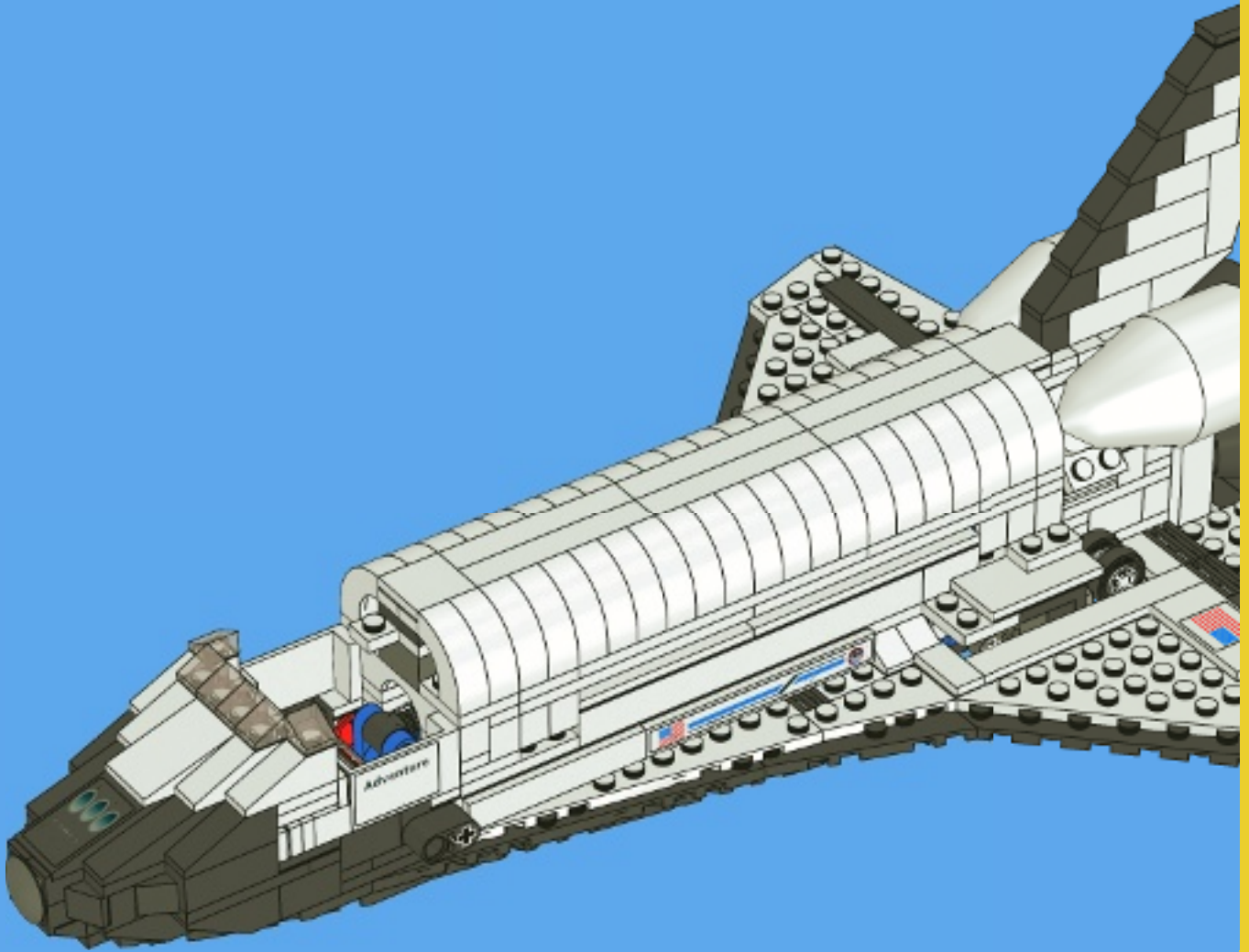

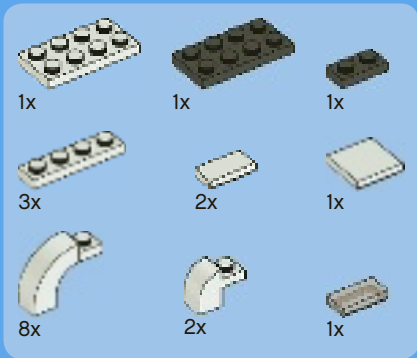

64

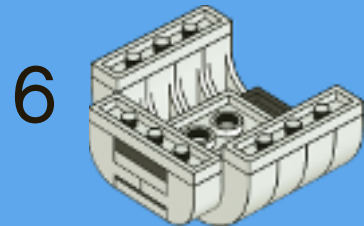
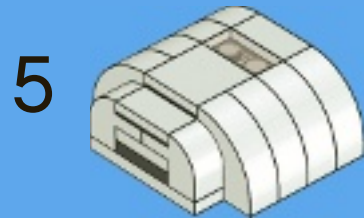
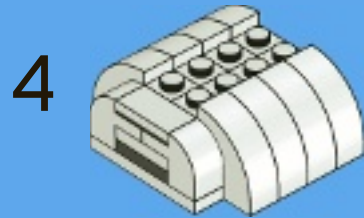
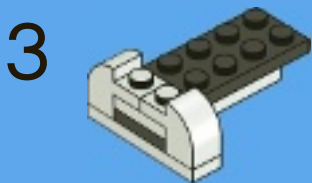
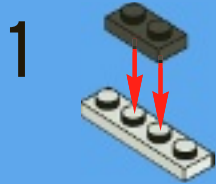

7

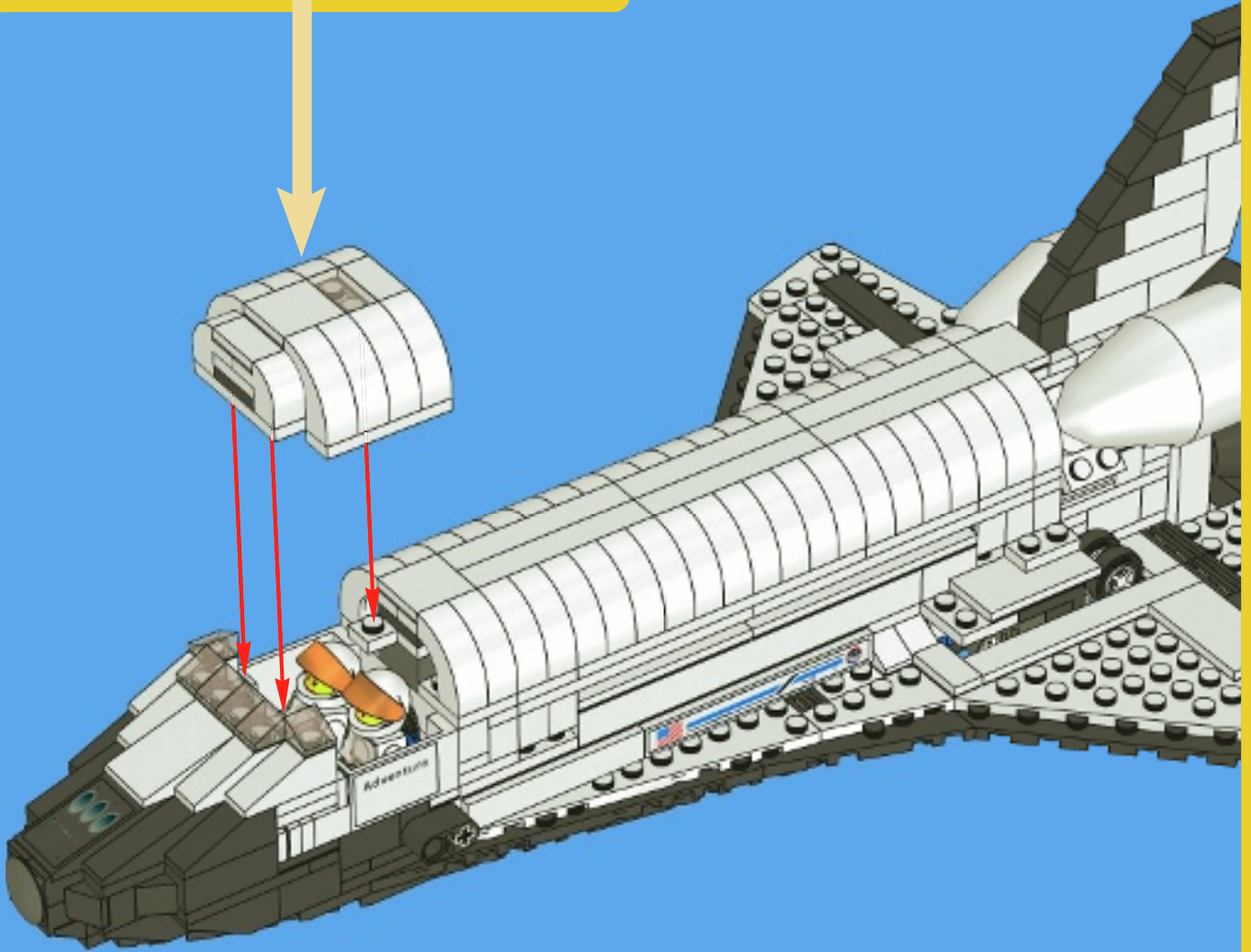
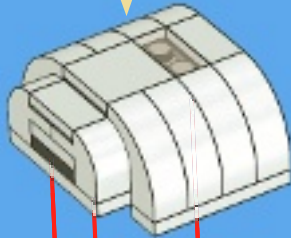
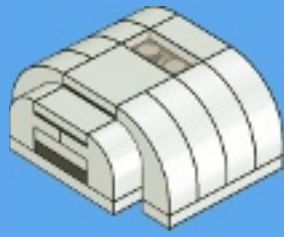

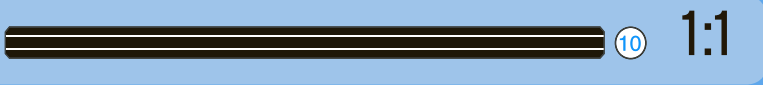
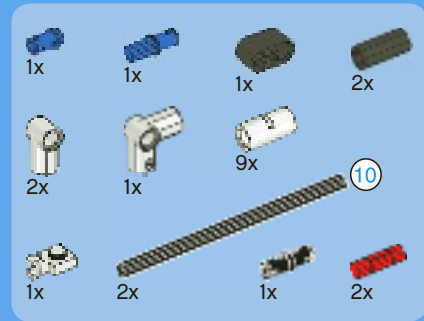

65

1



2



3

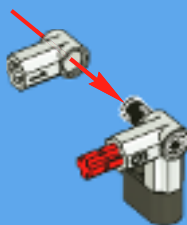

4

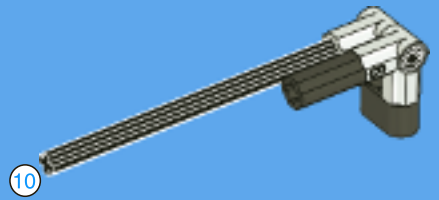

5

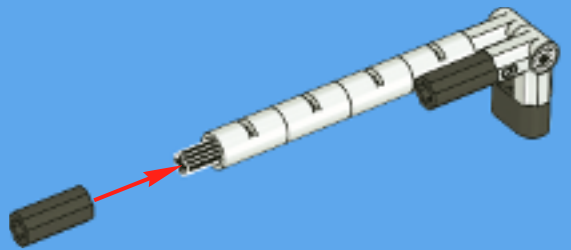

6

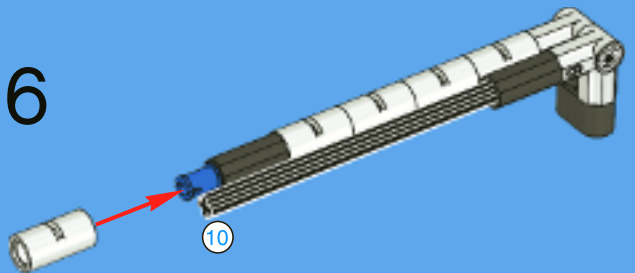

7

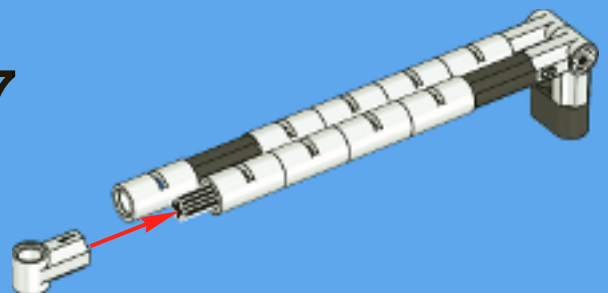

8

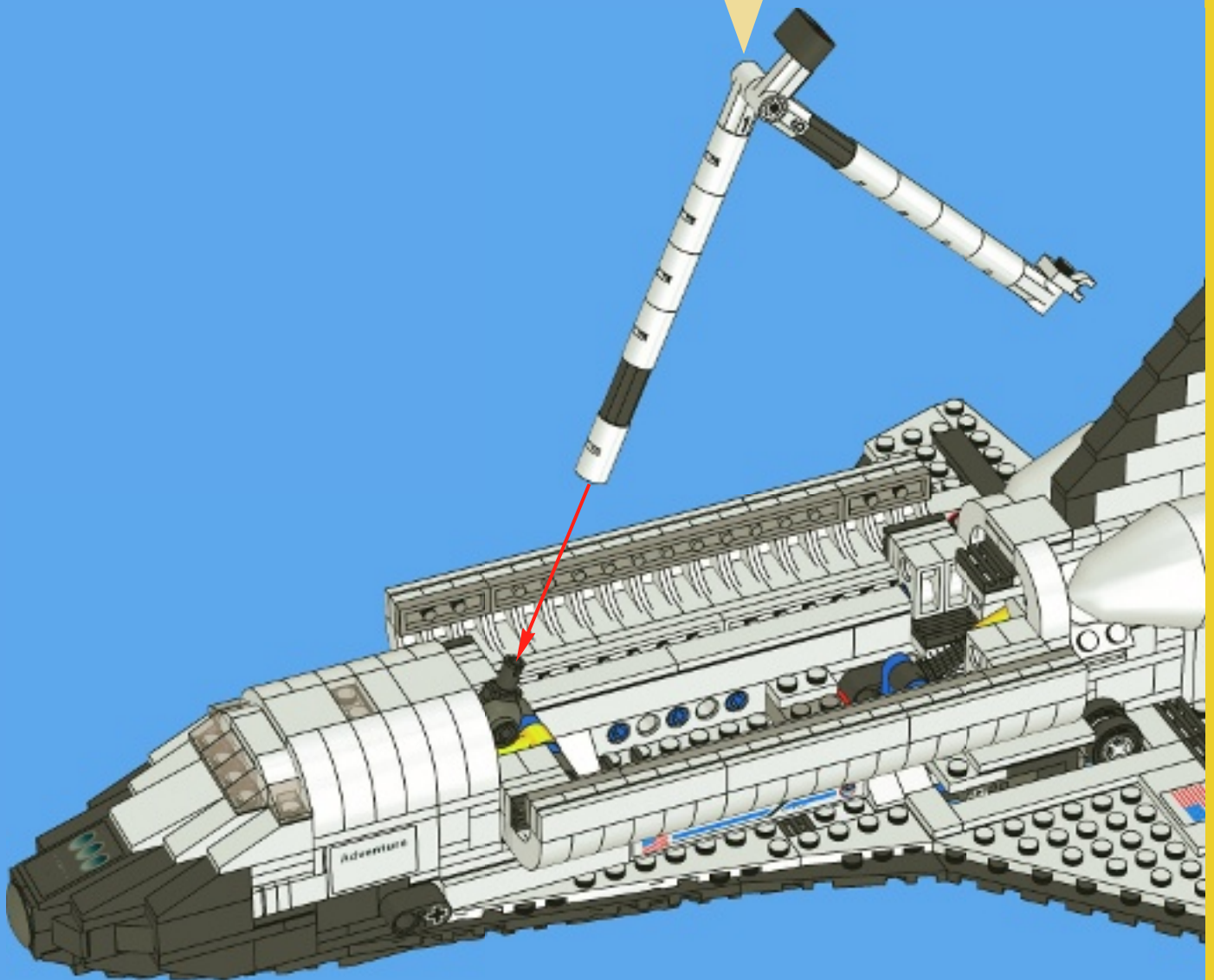
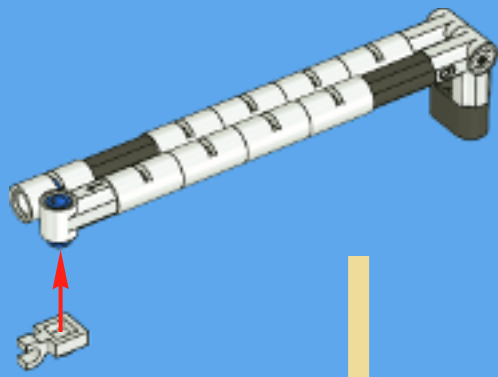

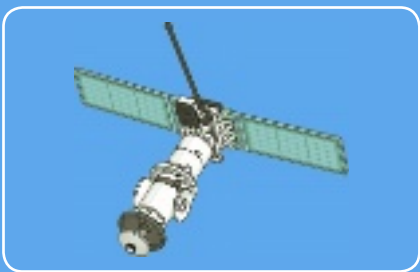

1



2

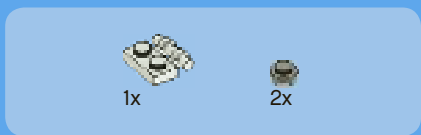

3

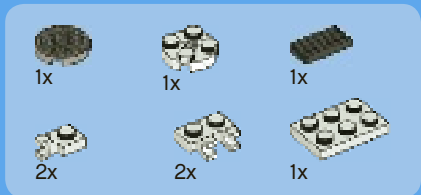

4

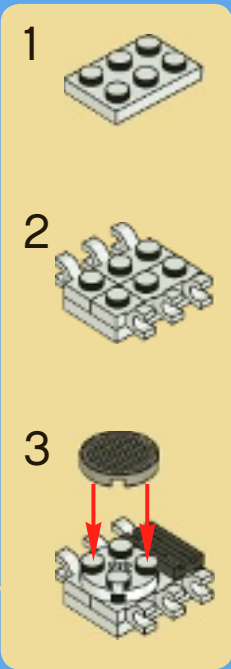



1x

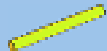

1x

5

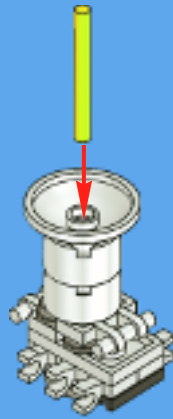

1x



3x



1x



1x



1x



1x

6

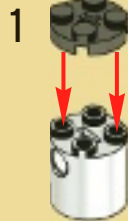

1

2



3

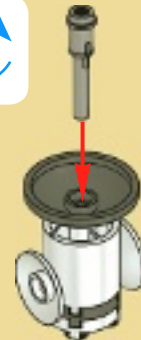

4

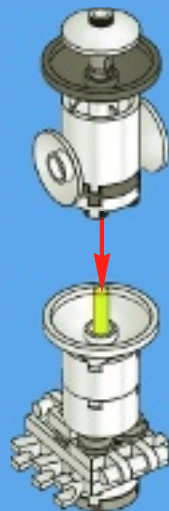
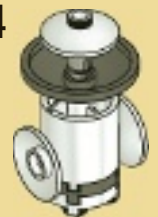

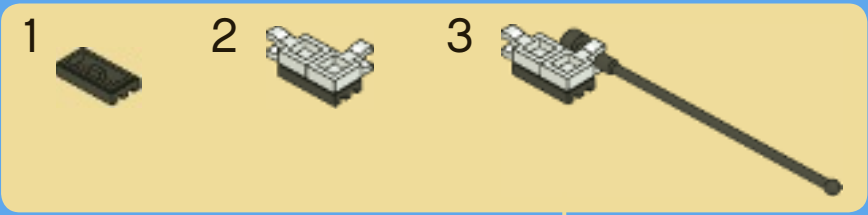

7

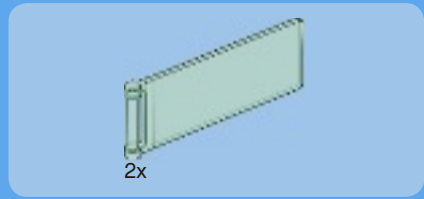
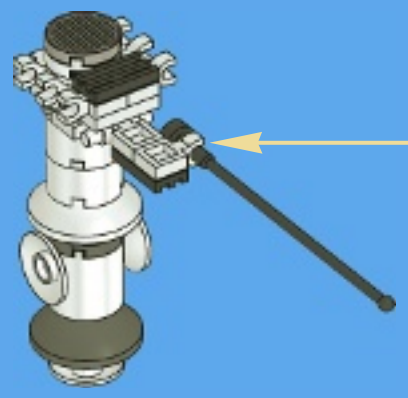

8

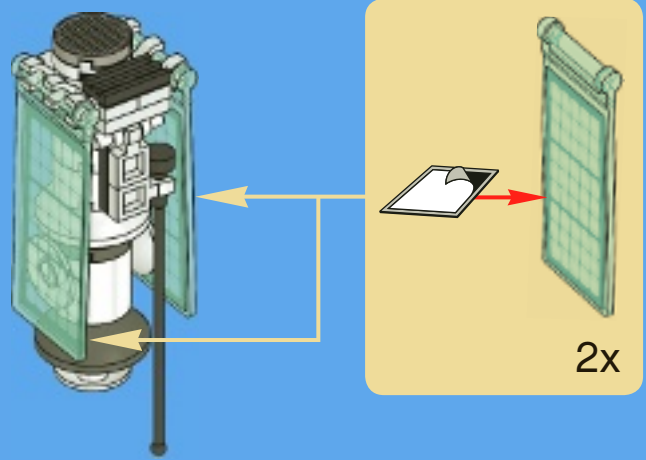

9

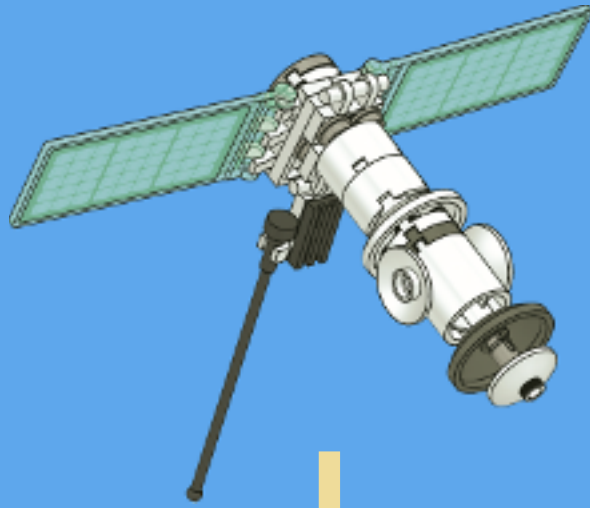

66

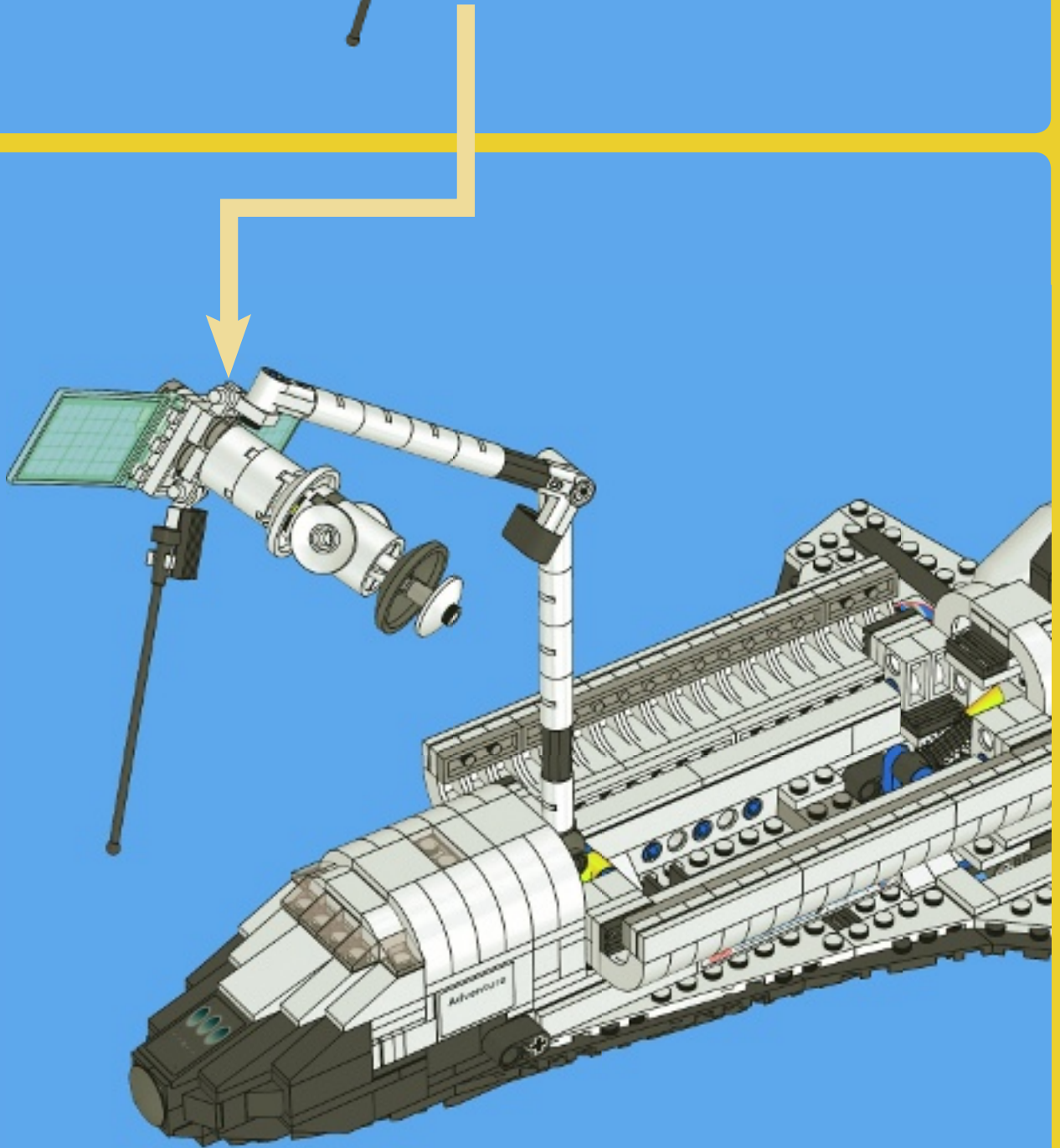

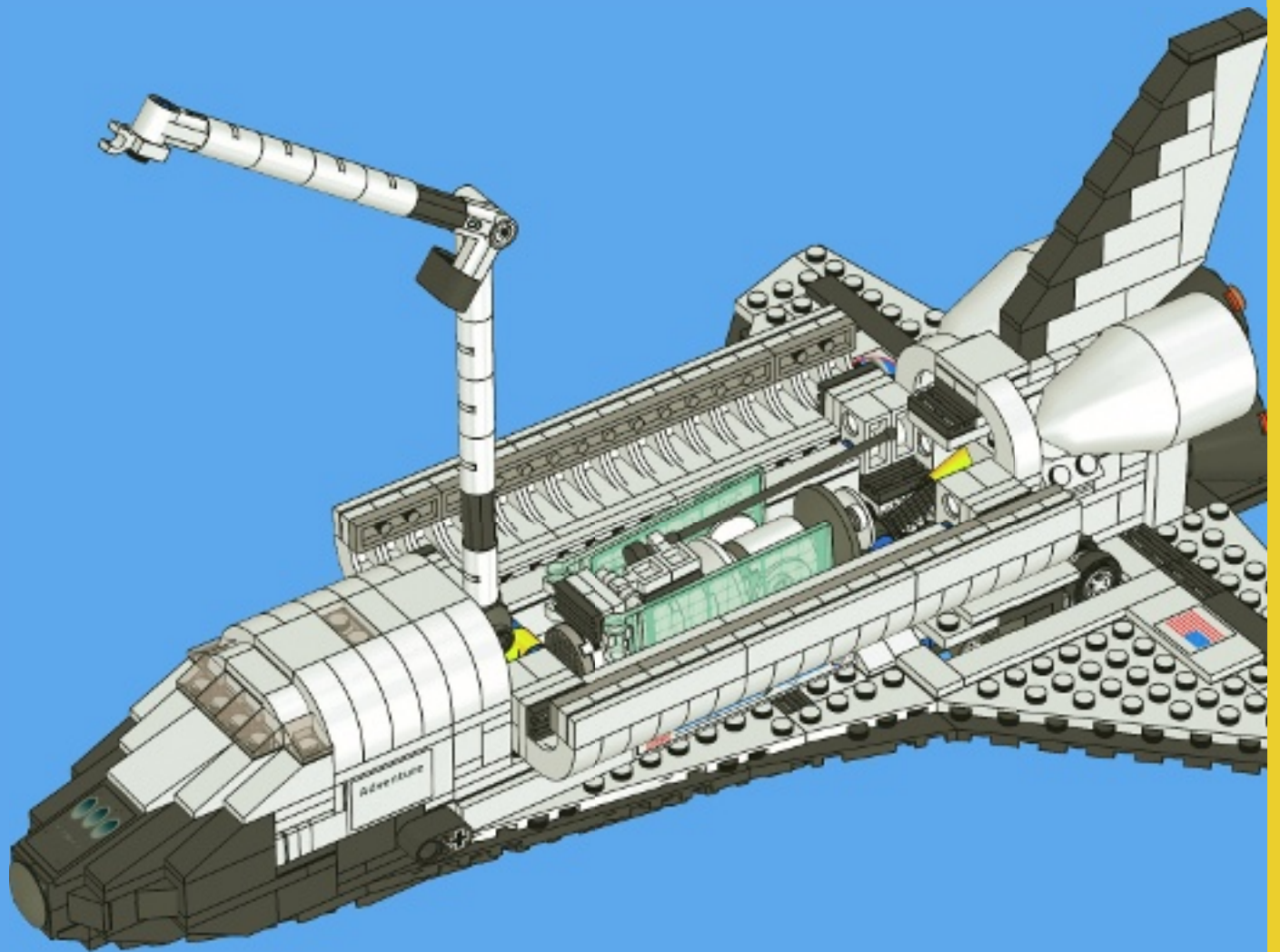

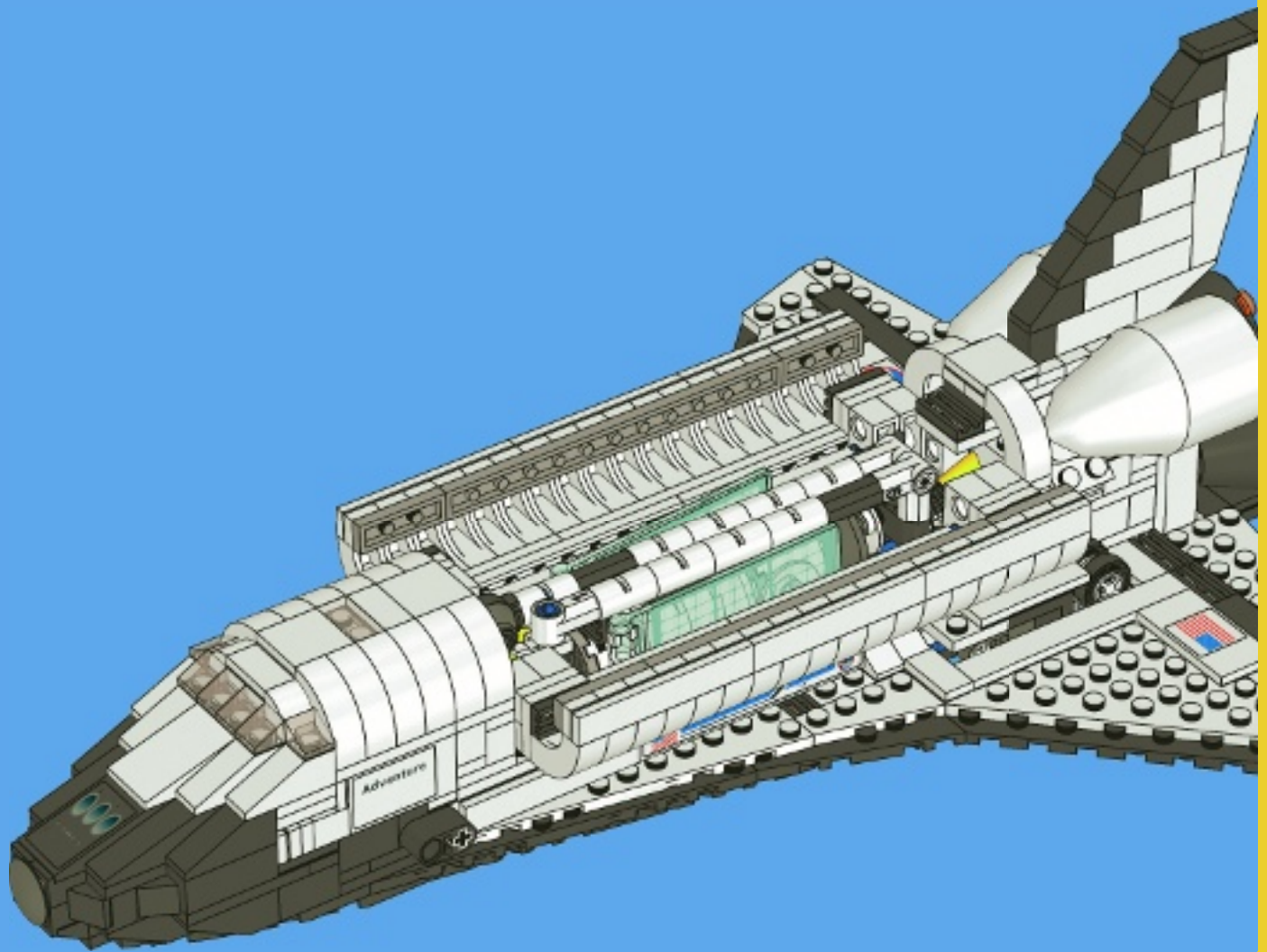

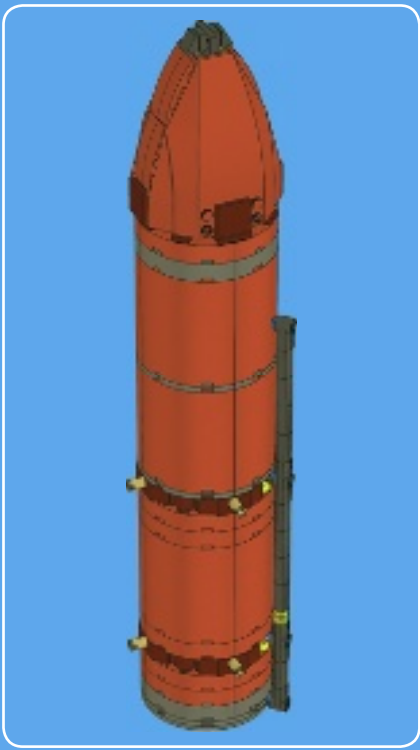

1

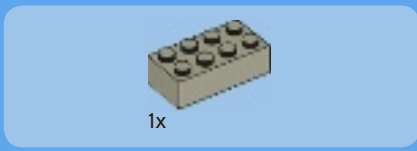
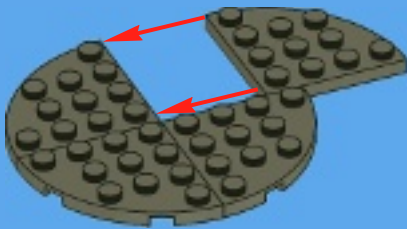

2



3





4x

4

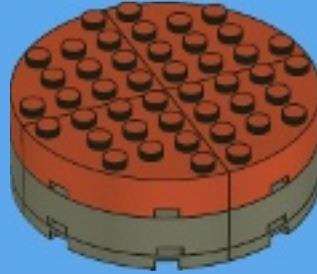

4x

5

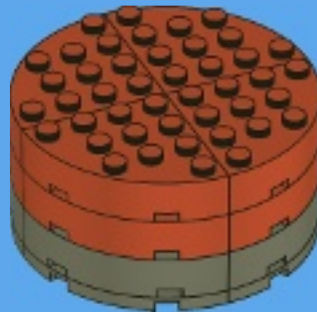



6

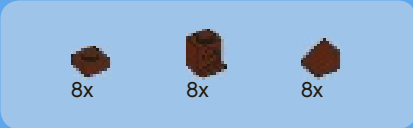
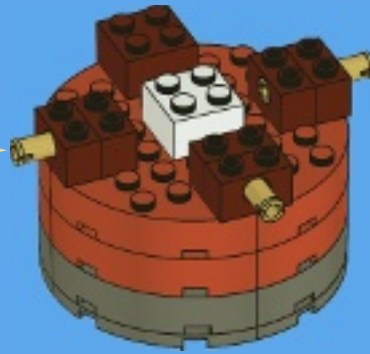

7

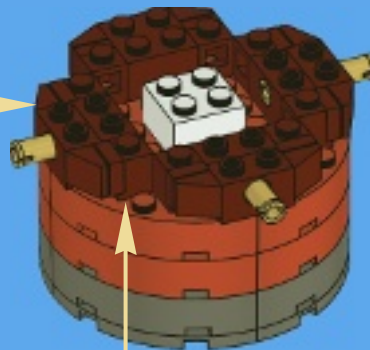
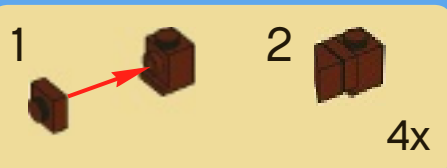



3x



1x

8



4x

9

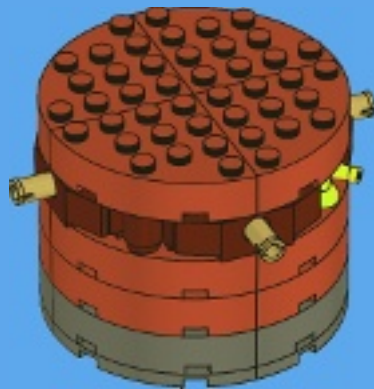

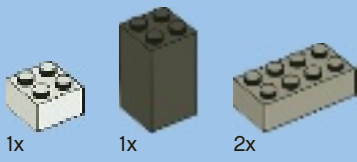

10

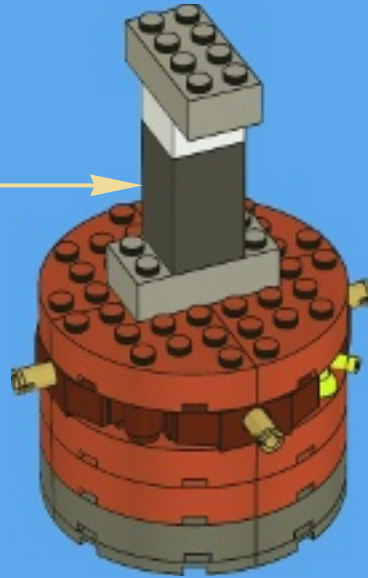
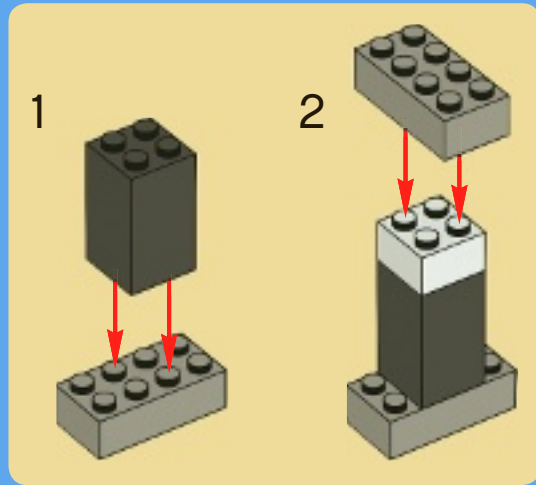

11

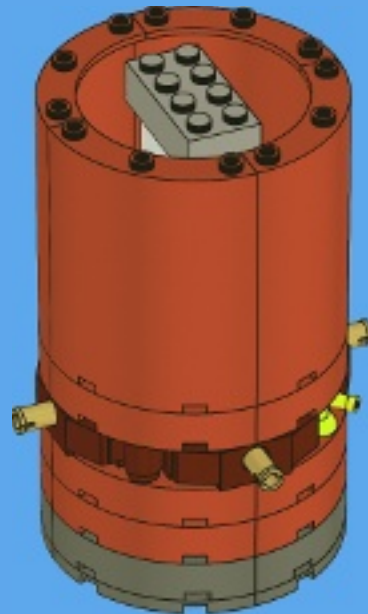



4x

12

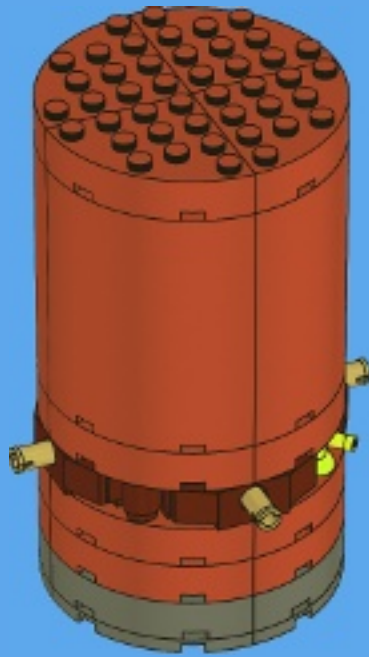

4x

13

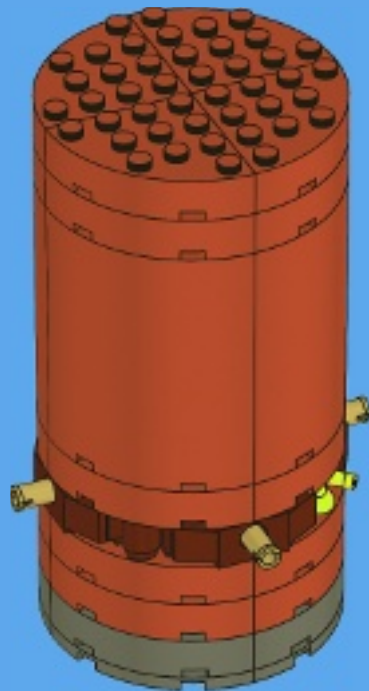

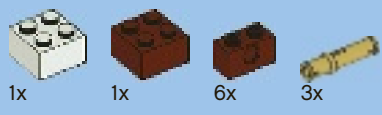

14

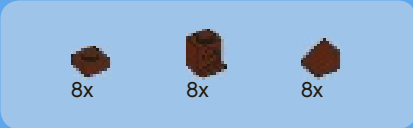
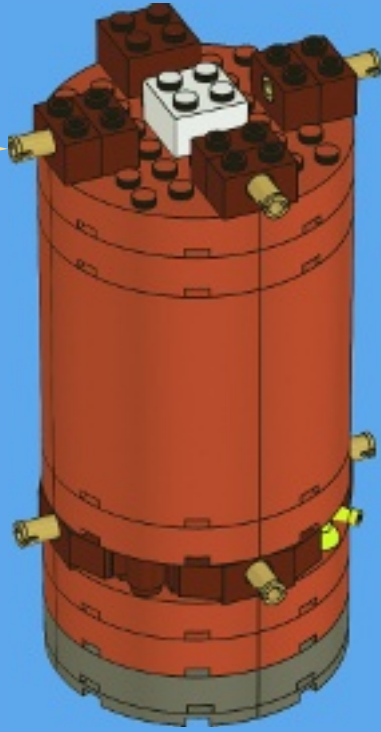
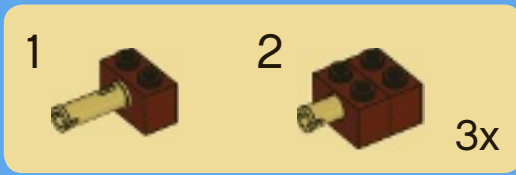

15

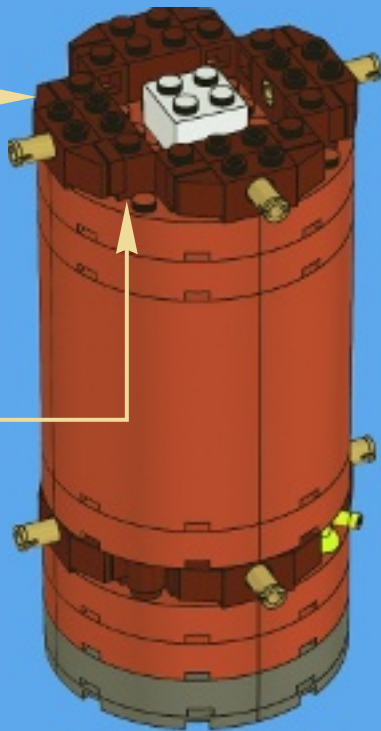



3x



1x

16

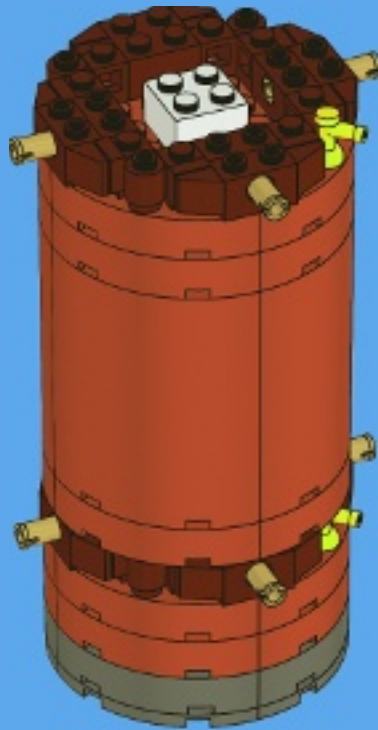

4x

17





1x



1x

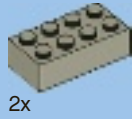

2x

18

1

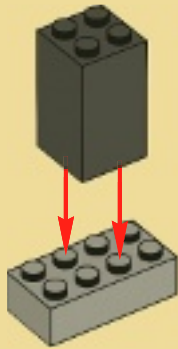

2

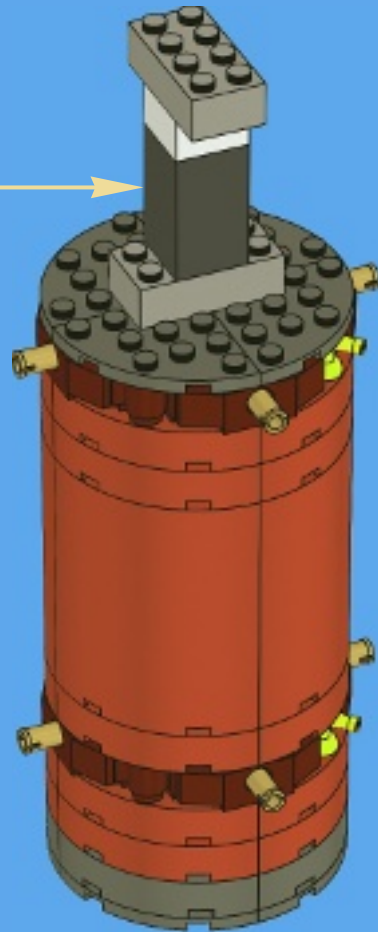
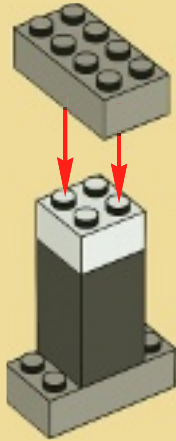



4x

19

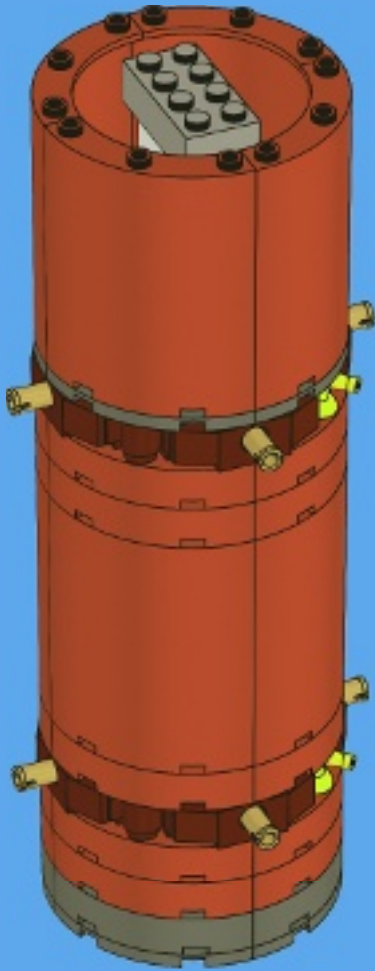

4x

20

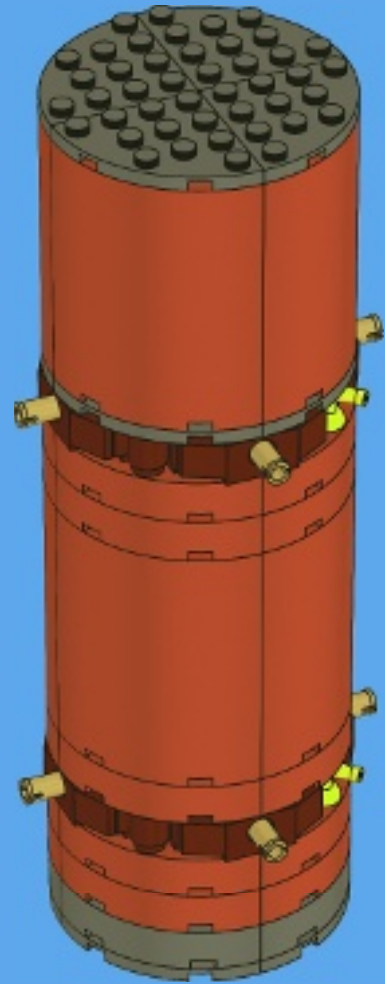



2x



1x

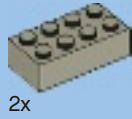

2x

21

1

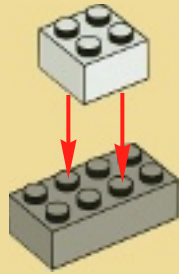

2

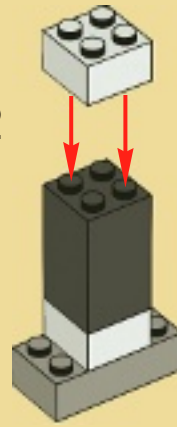

3

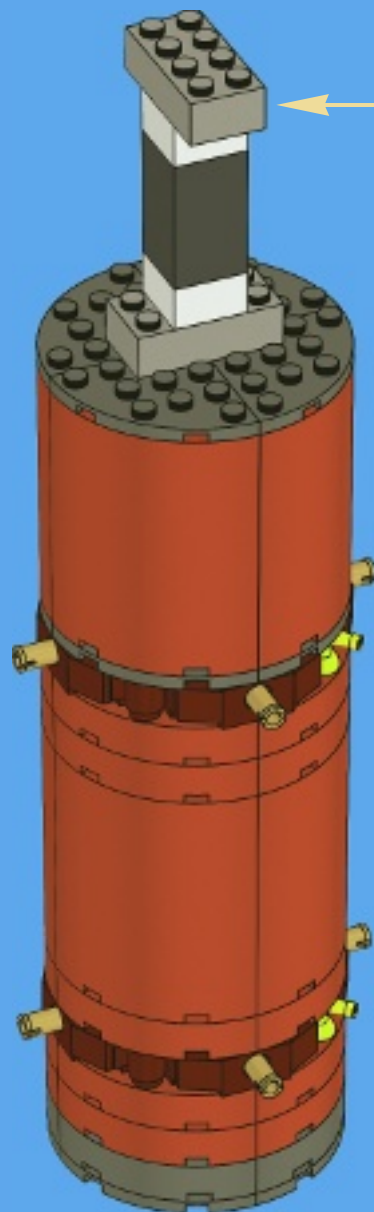
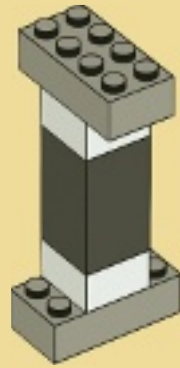



4x

22

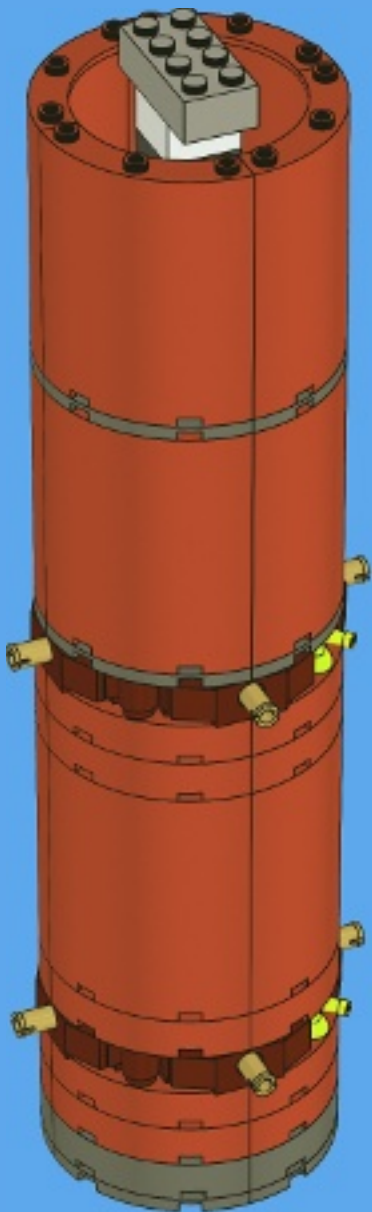

4x

23

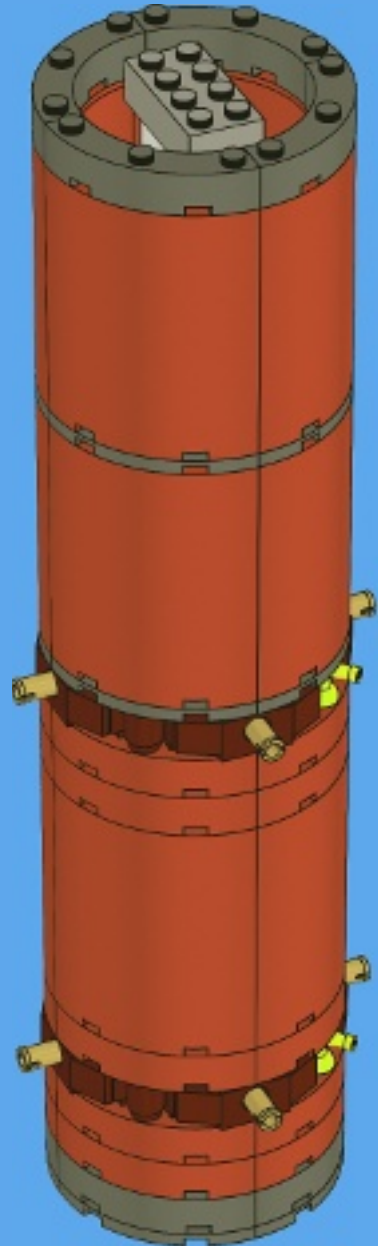



4x

24

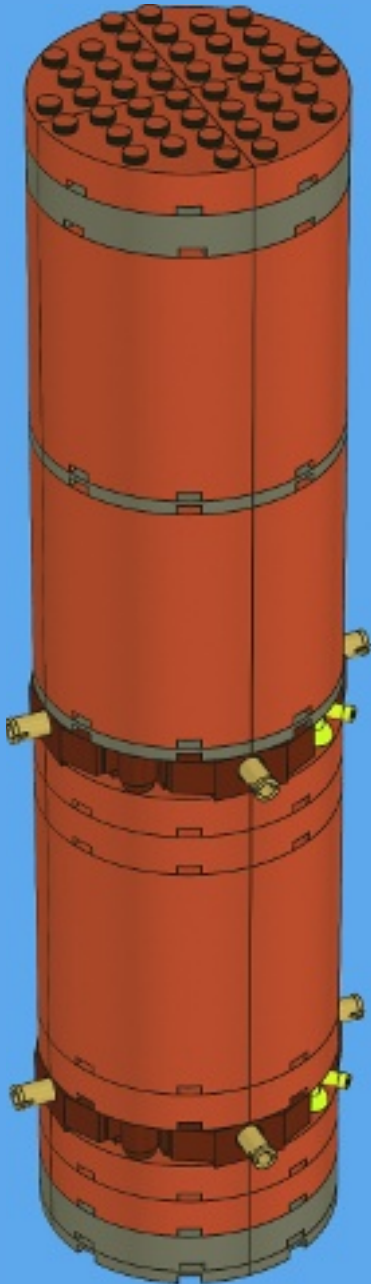

4x



4x

25

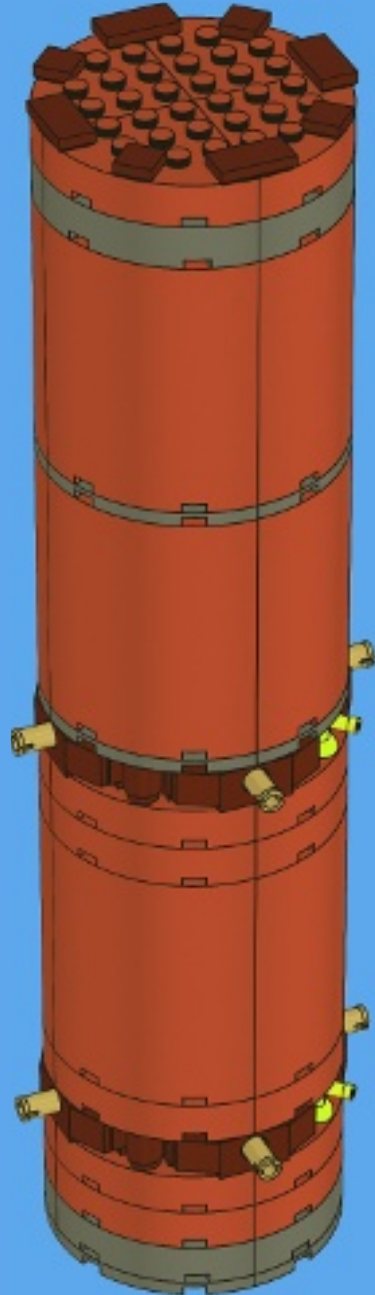



26

1



2



3



4

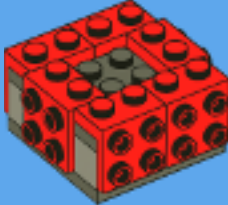

5



6

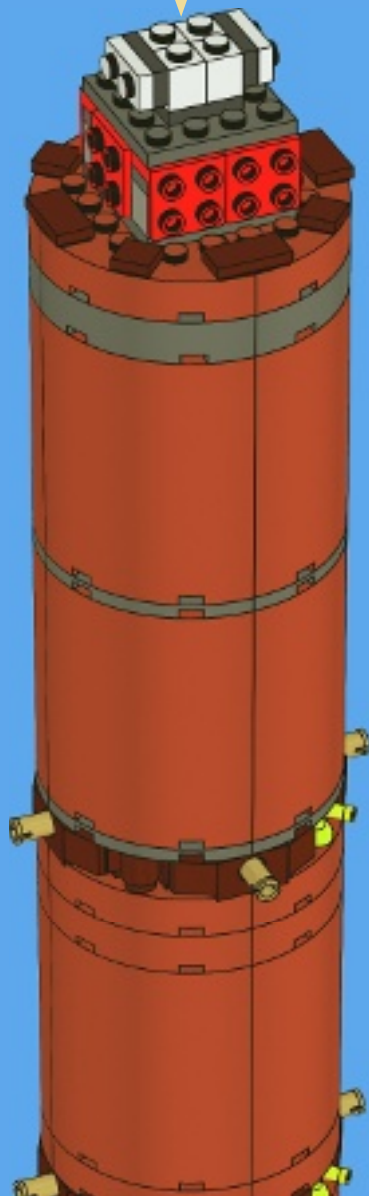
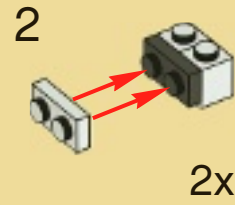
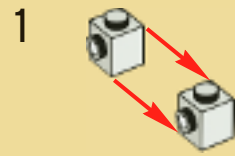

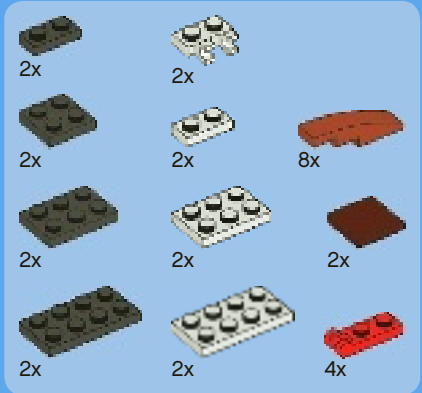

27

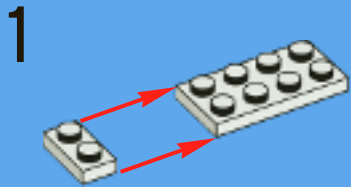

3



4



5



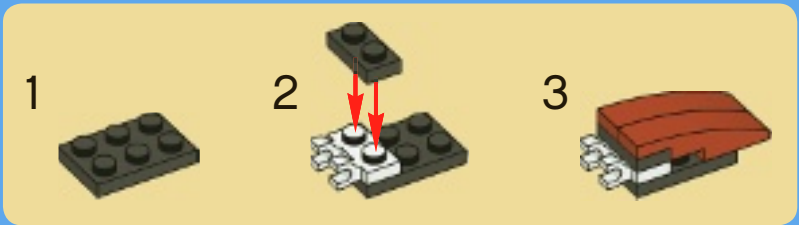

6

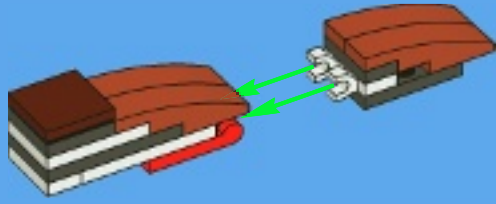

2x

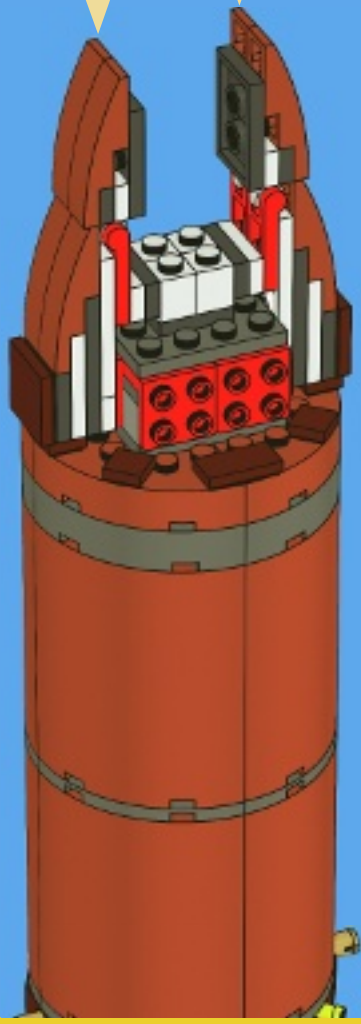

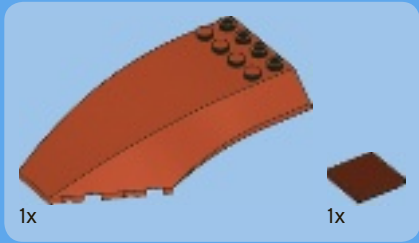

1

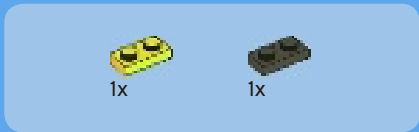
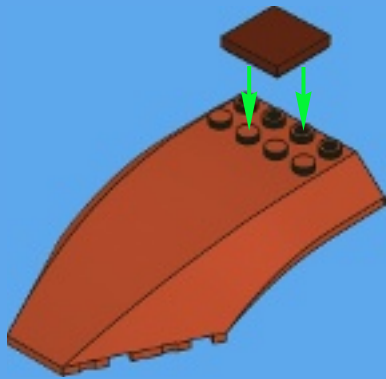

2

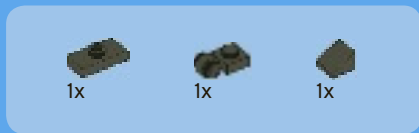
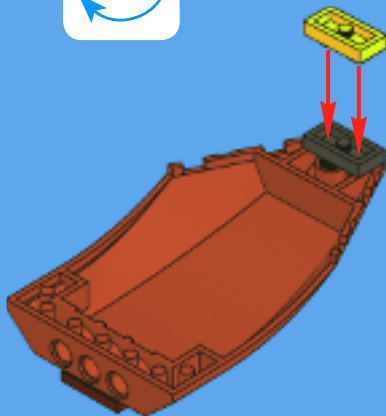

3

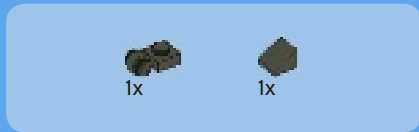
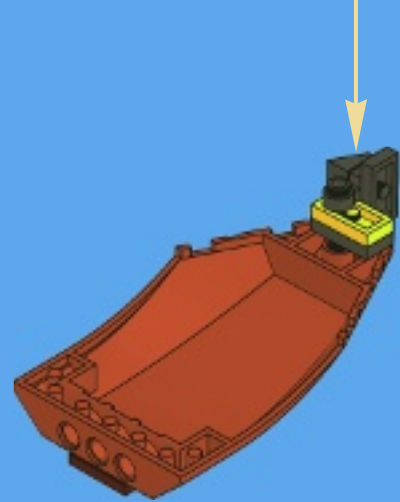
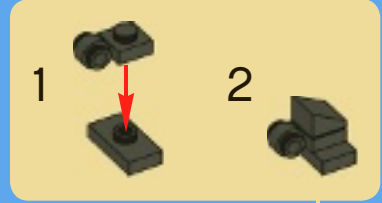

4

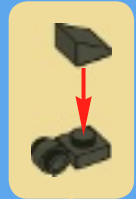



1x



1x

5



1x



1x

6

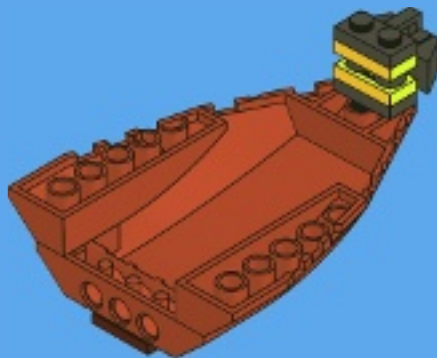

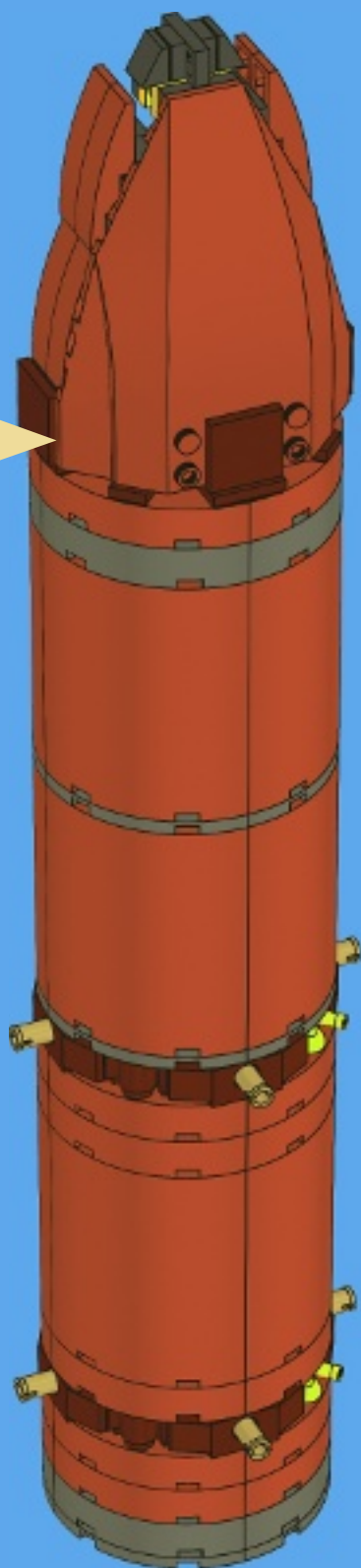

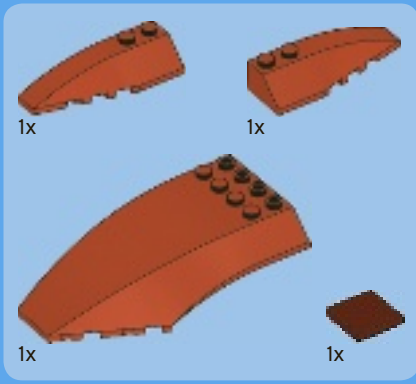

29

1

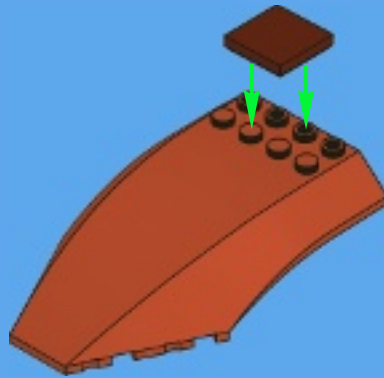

2

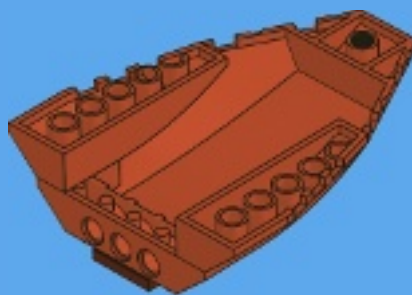

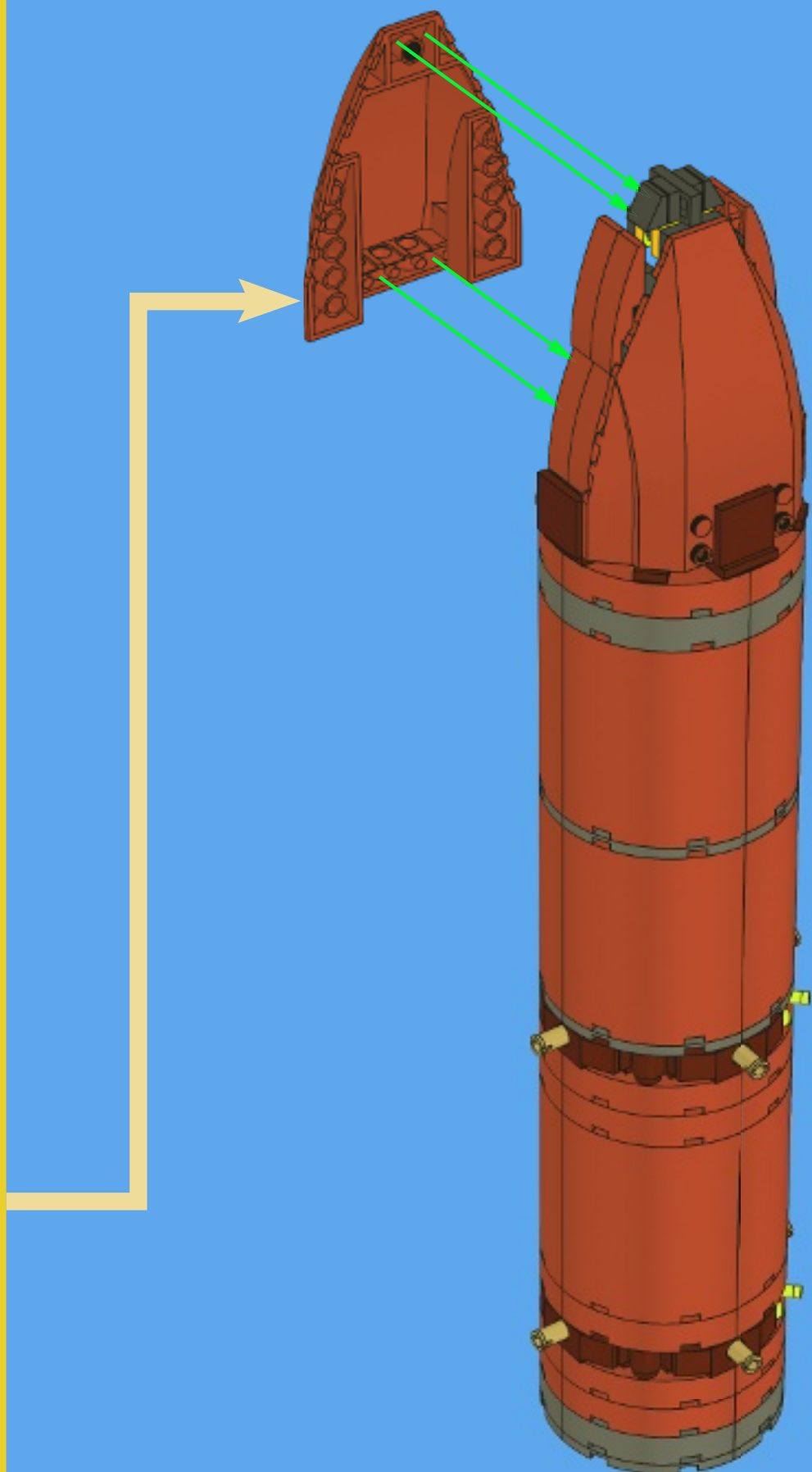

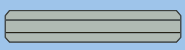

1:1



1x



11x



4x



2x



2x



9x



2x

30

1

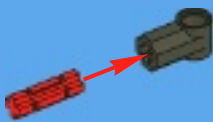

2

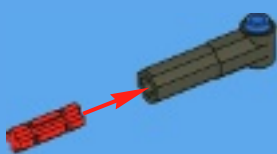

3

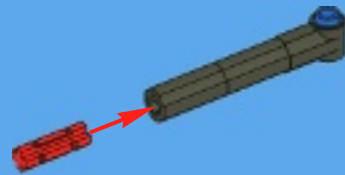

4

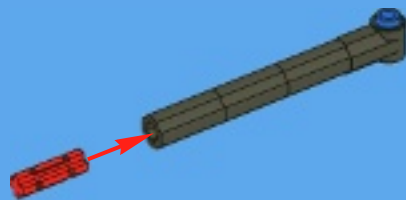

5

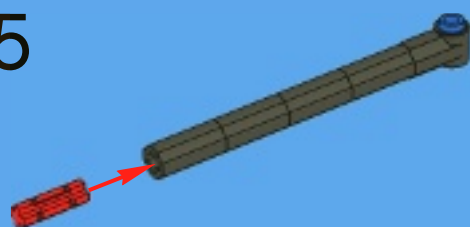

6



7



8



9



10



11



12



13



14



31

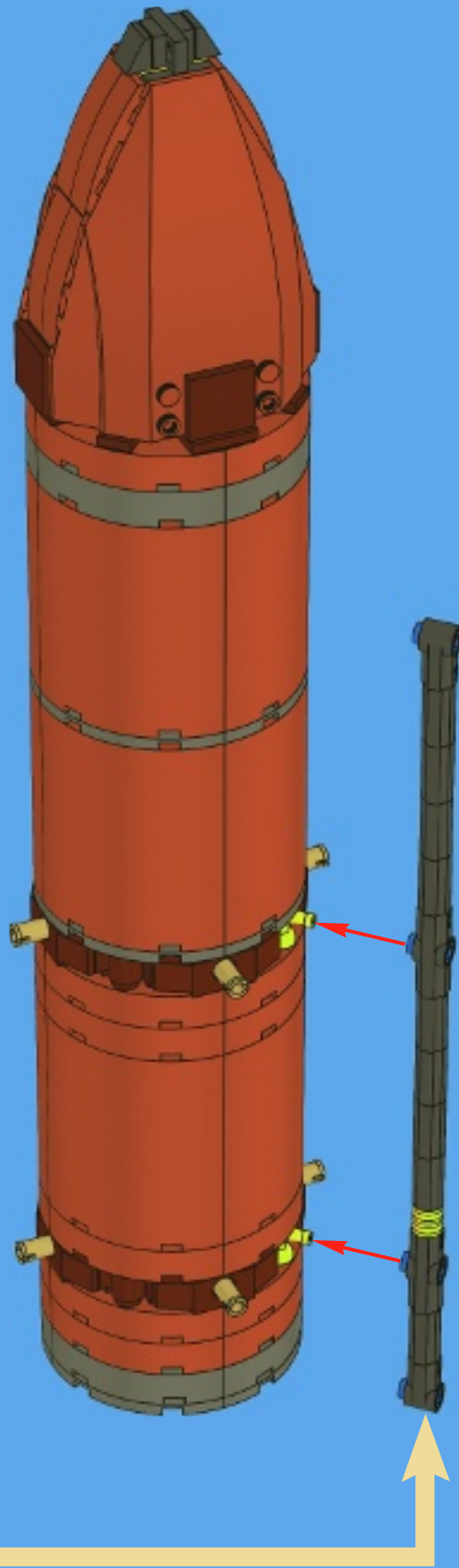



1x

32

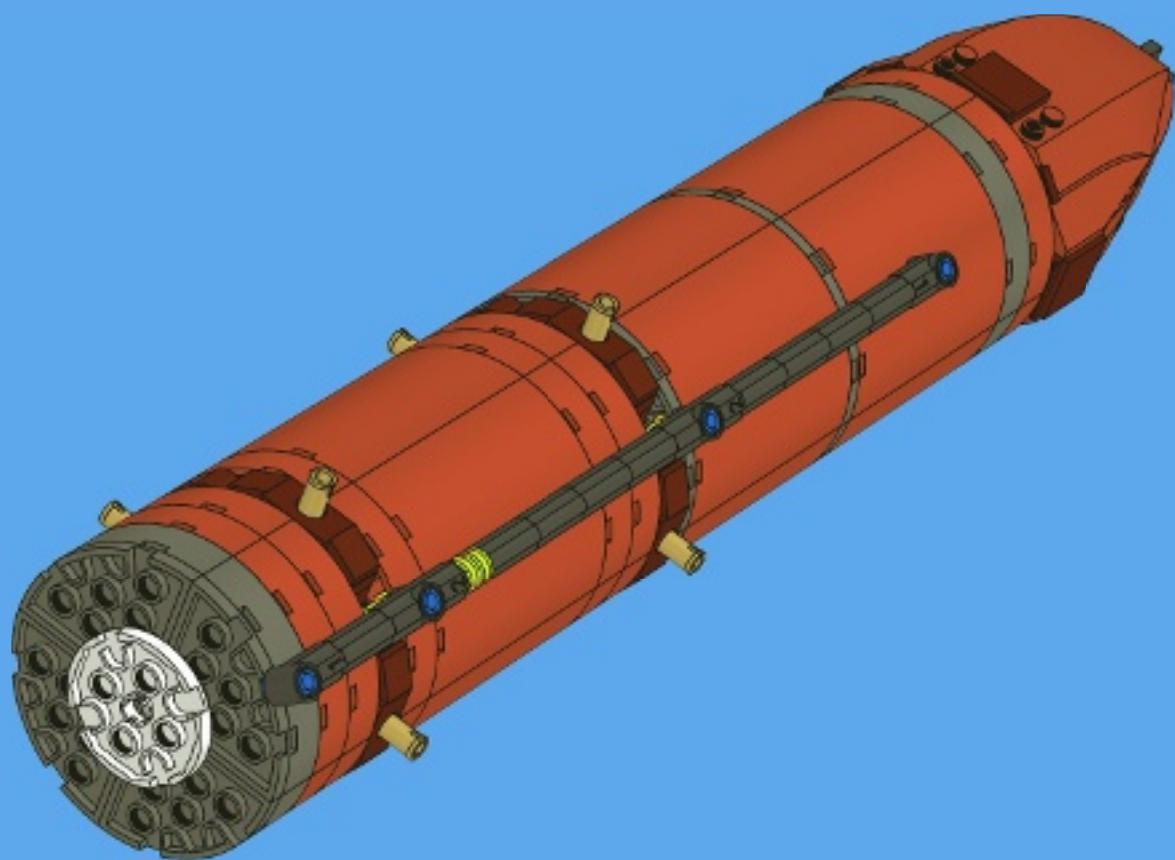



1x



1x

33

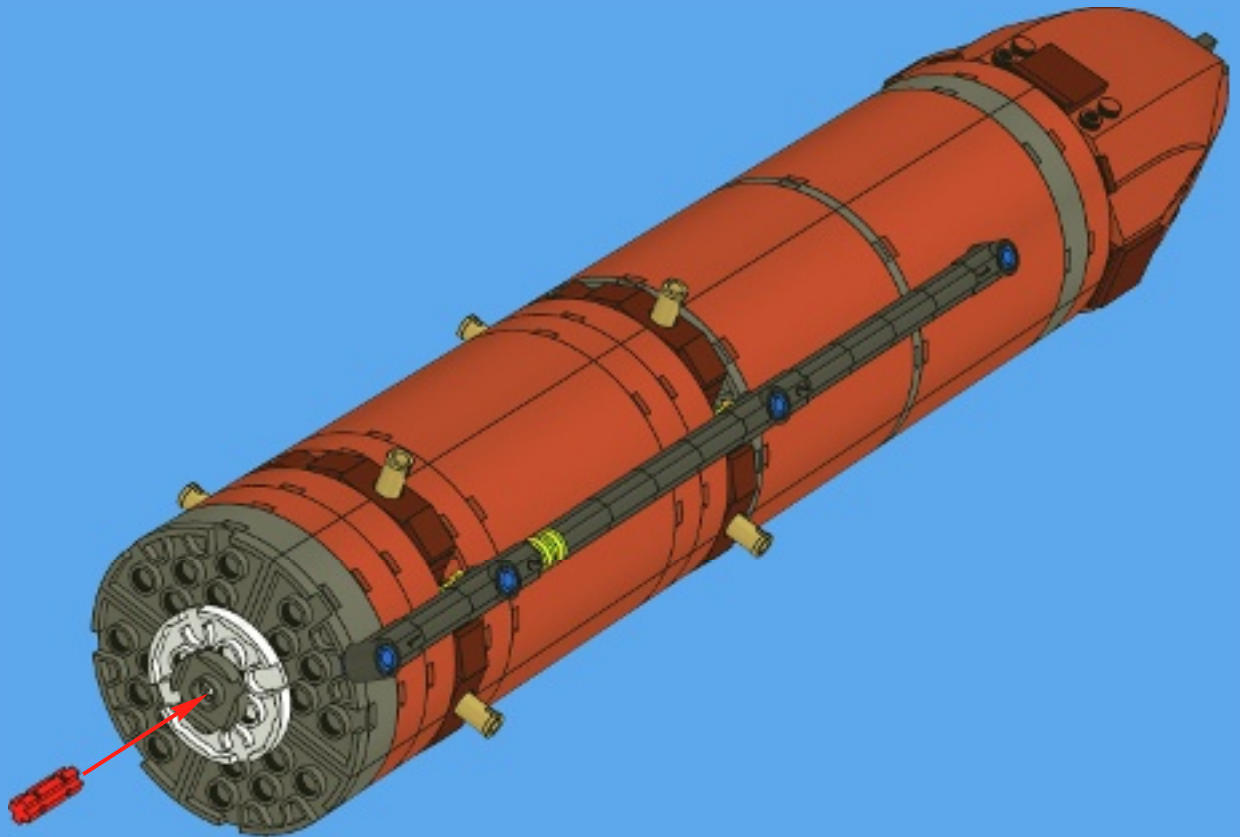

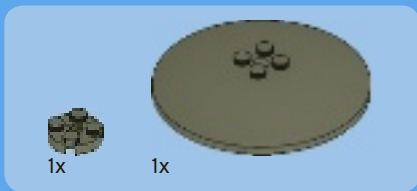

34

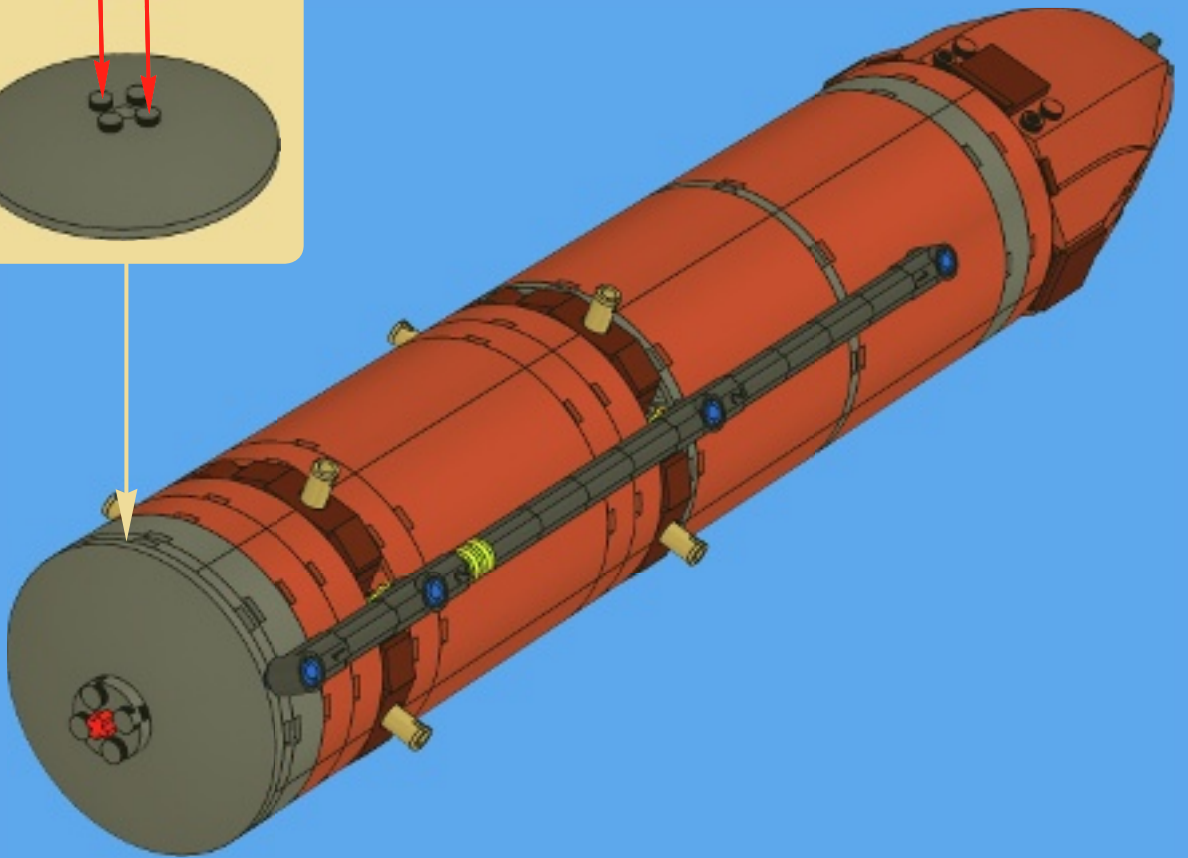
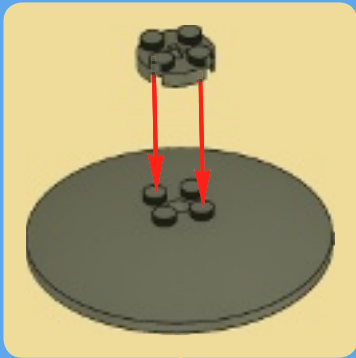

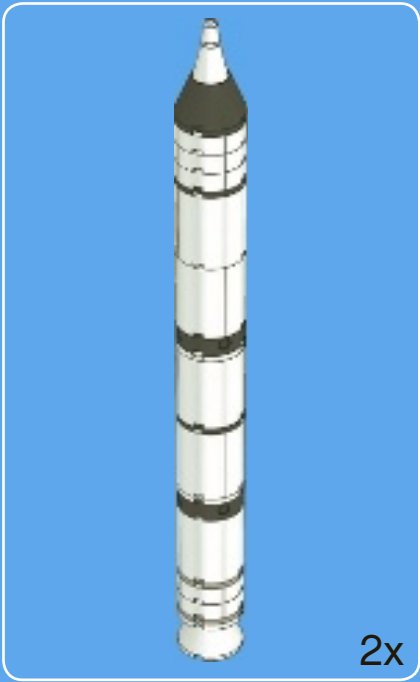

1

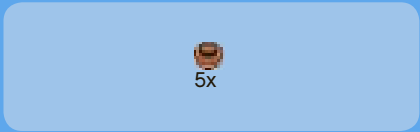

2

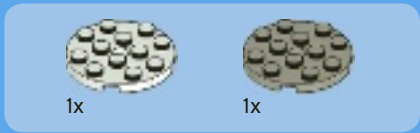

3

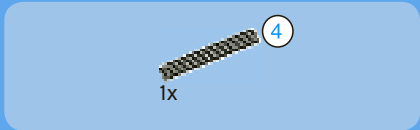

4

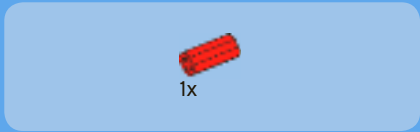
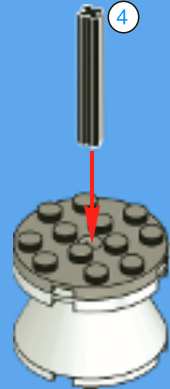

5





4x

6



1x



4x

7

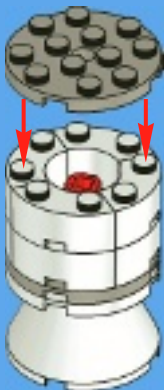

2x

8



1x



1x

9



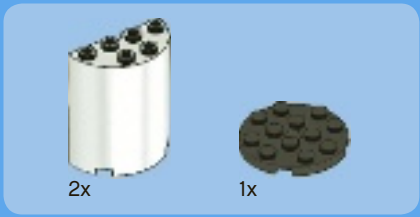

10



11



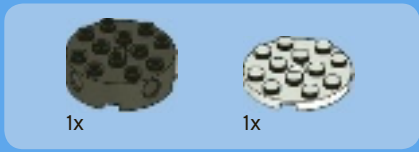

12

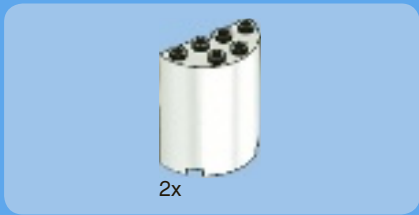

13



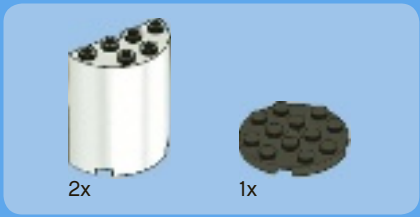

14



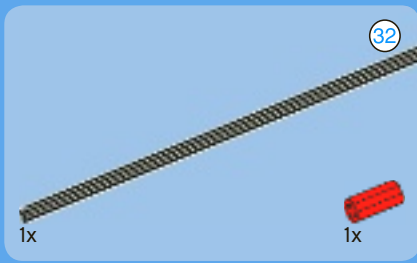

15





12x

16

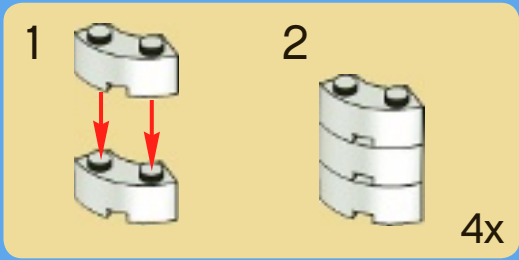

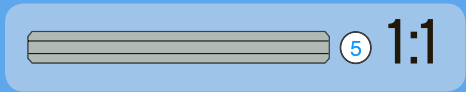
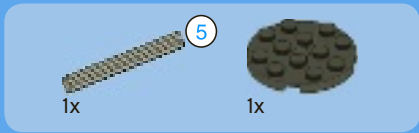

17



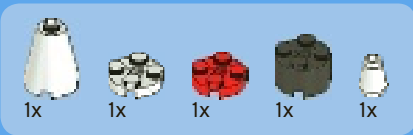

18

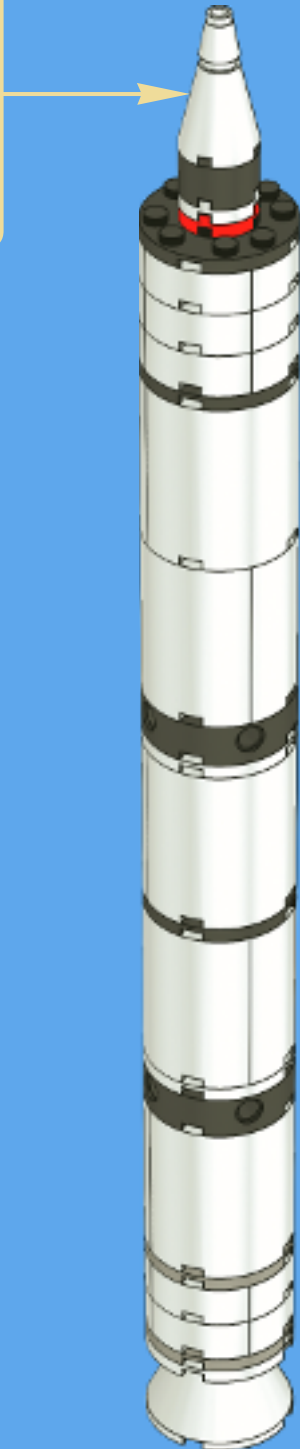
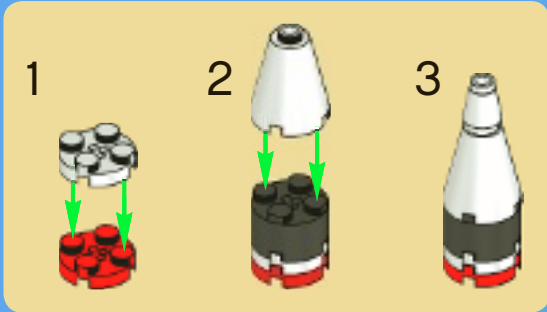



1x

19



2x

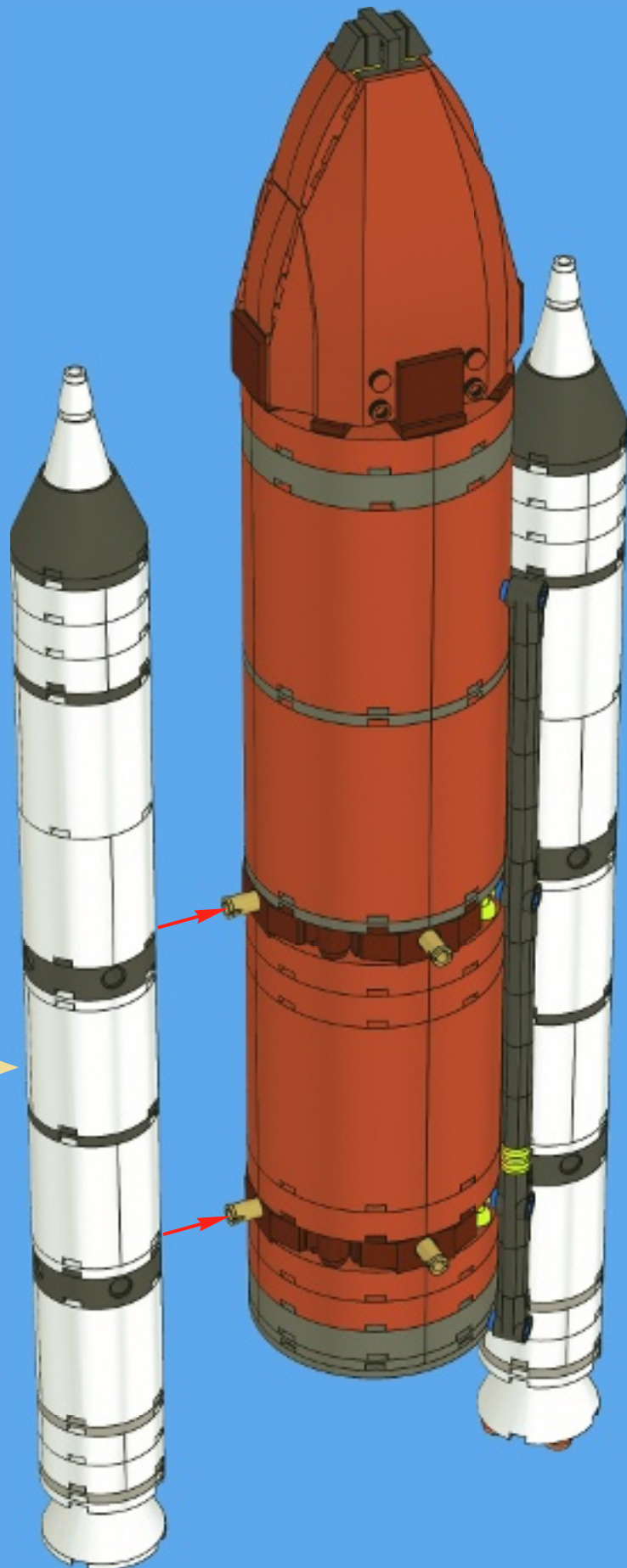

21

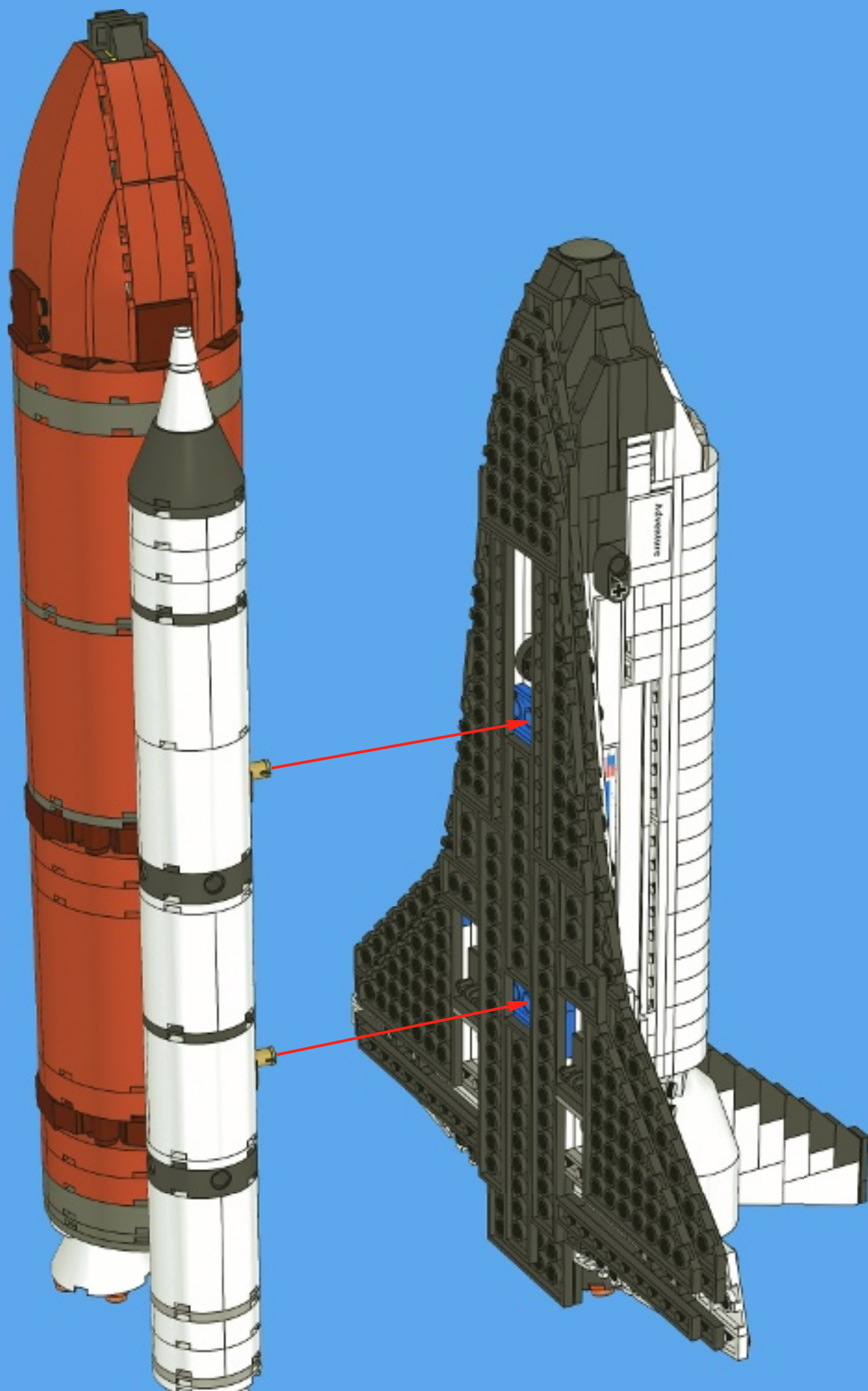

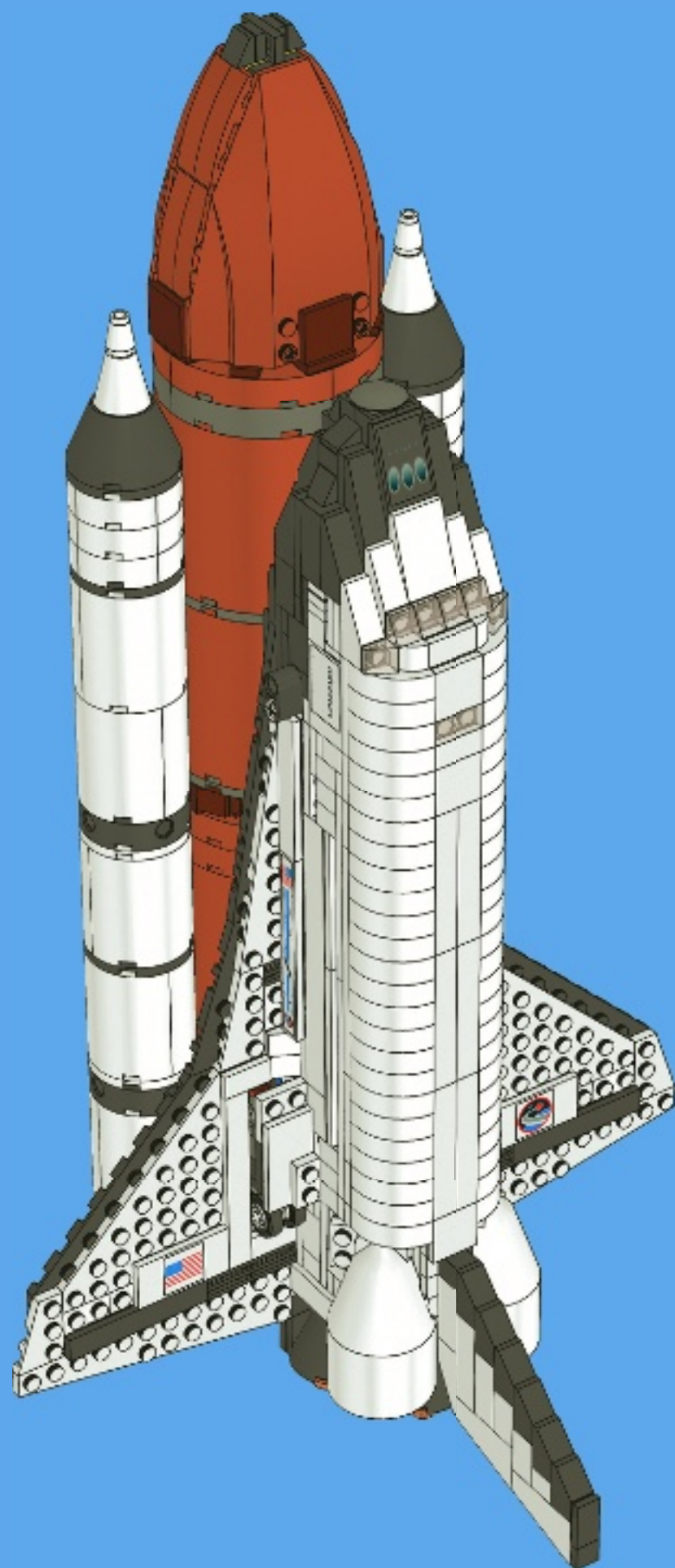

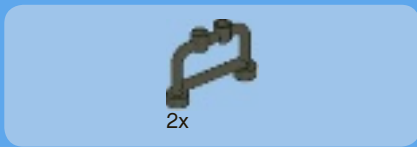
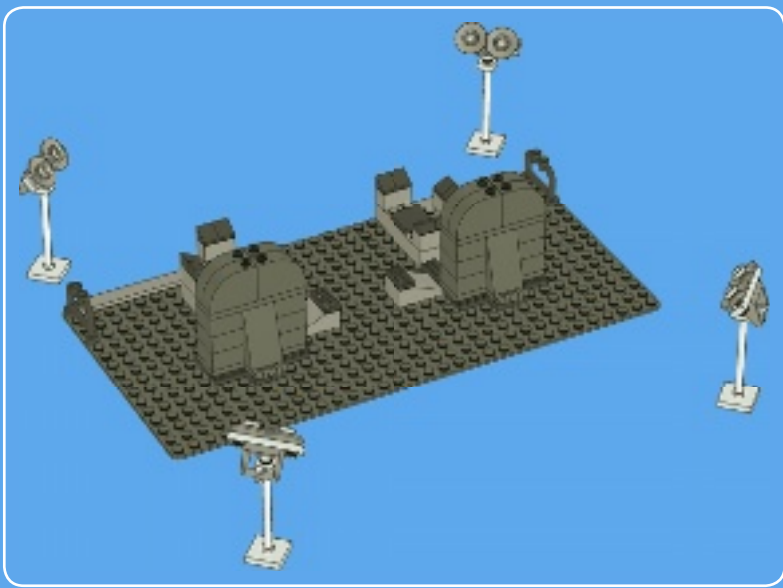

1

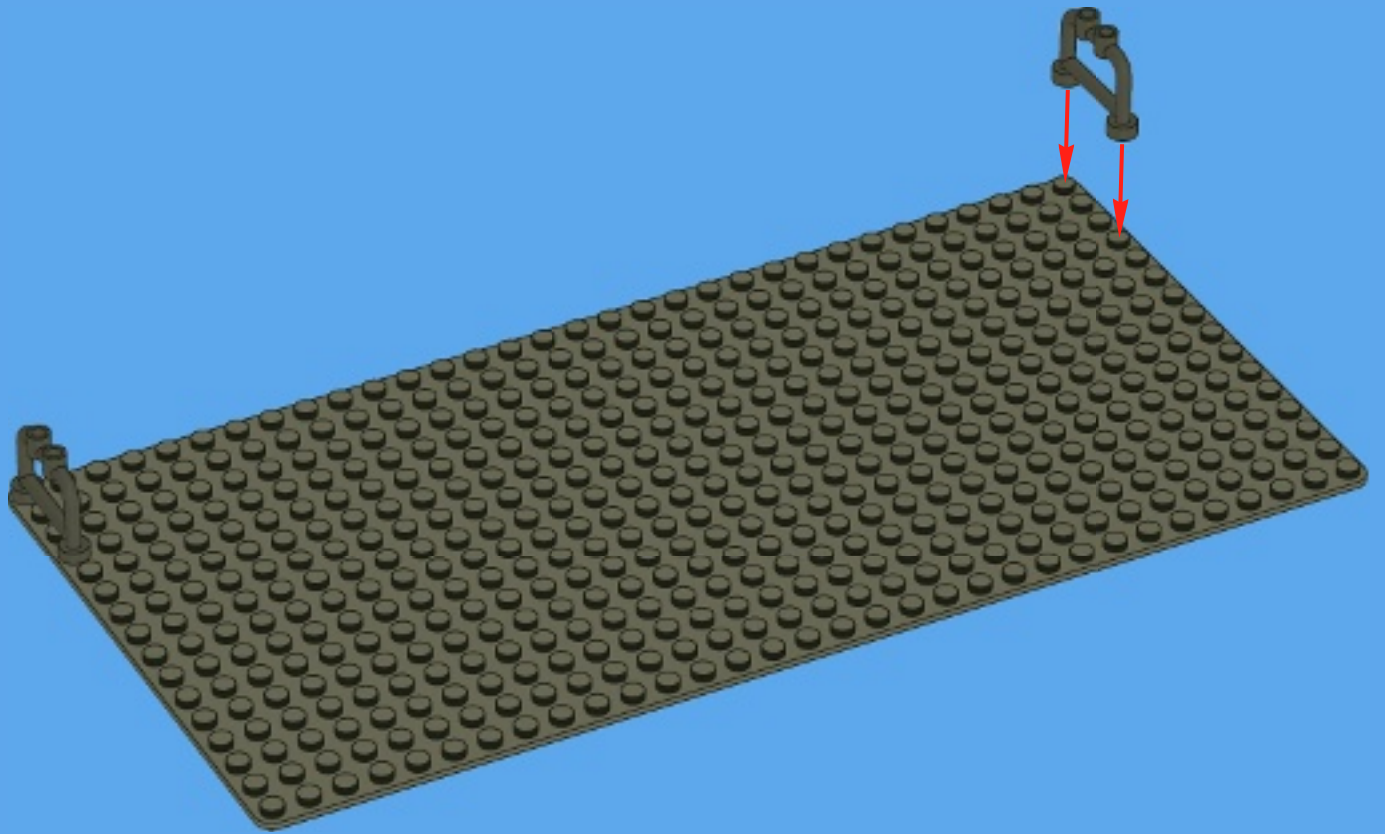

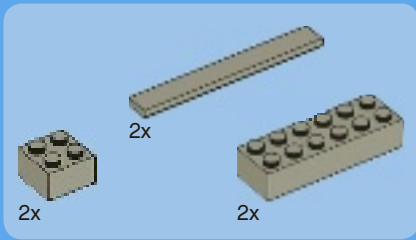

2

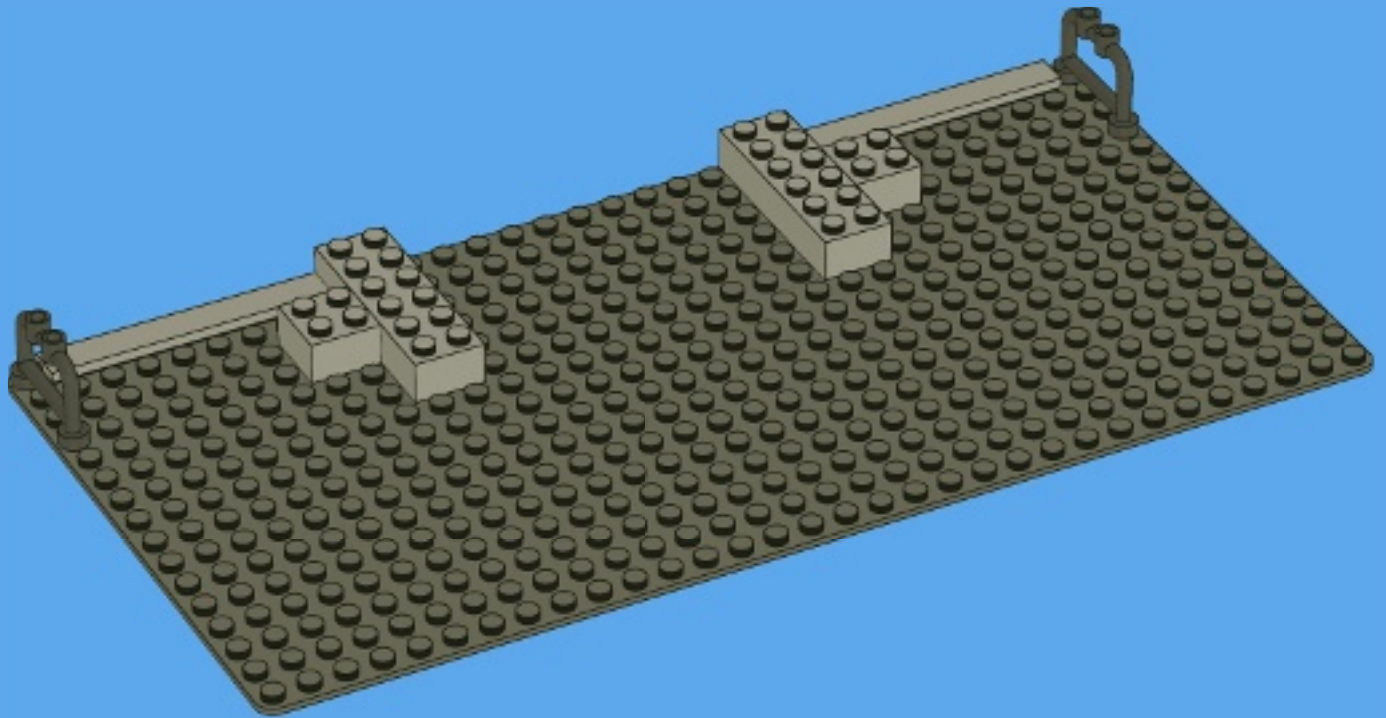



3

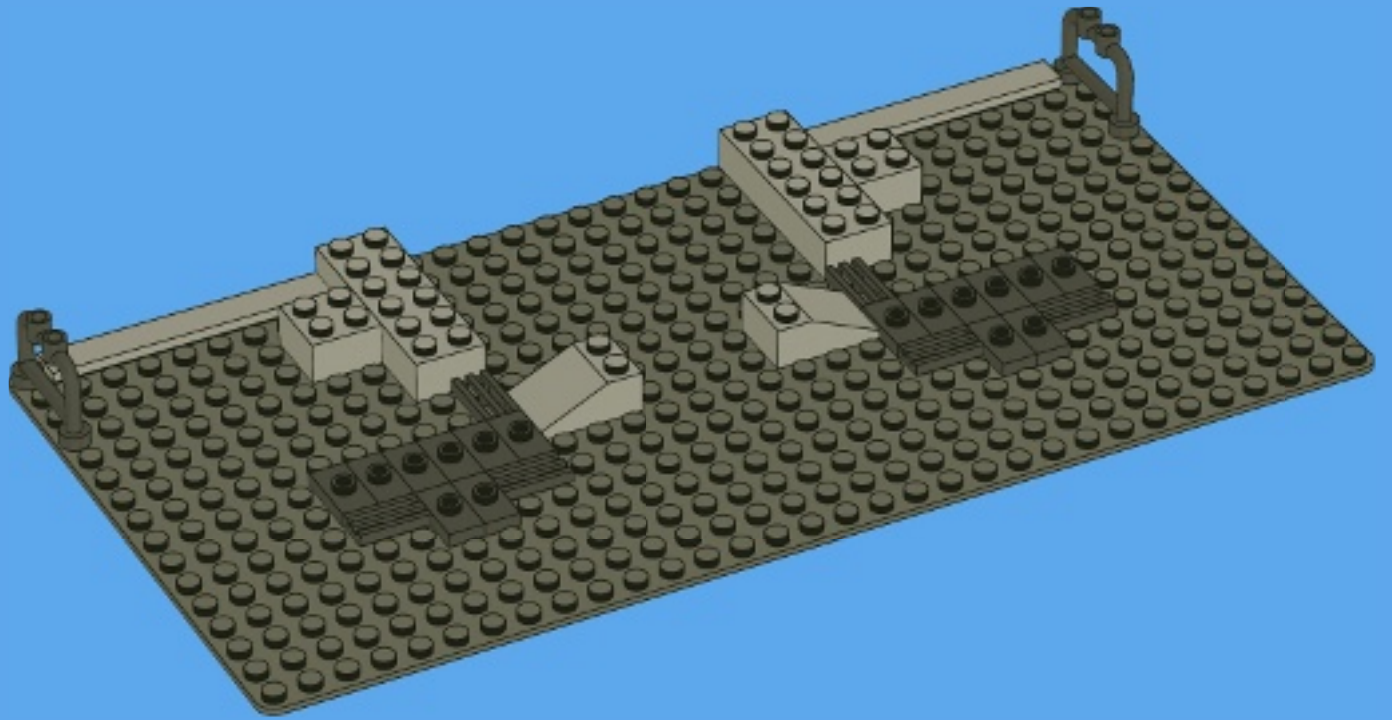



2x



2x



6x

4

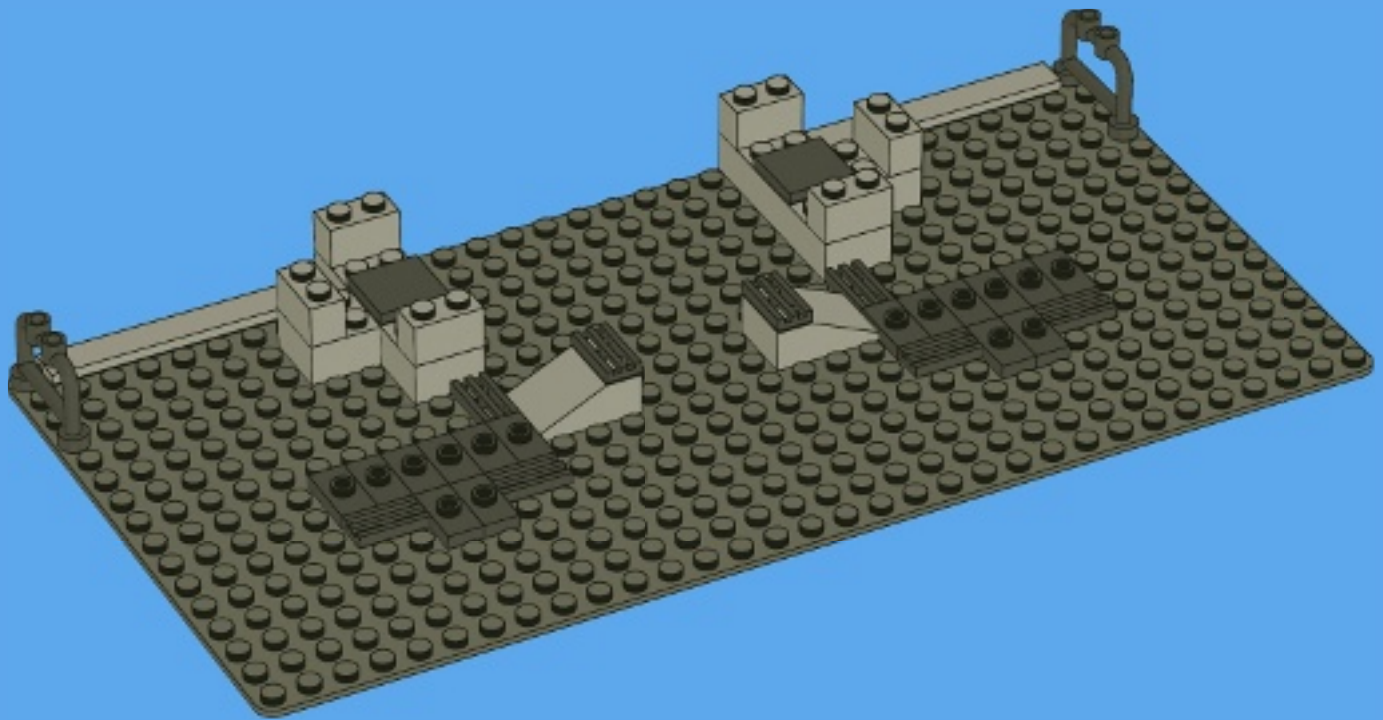



12x

5

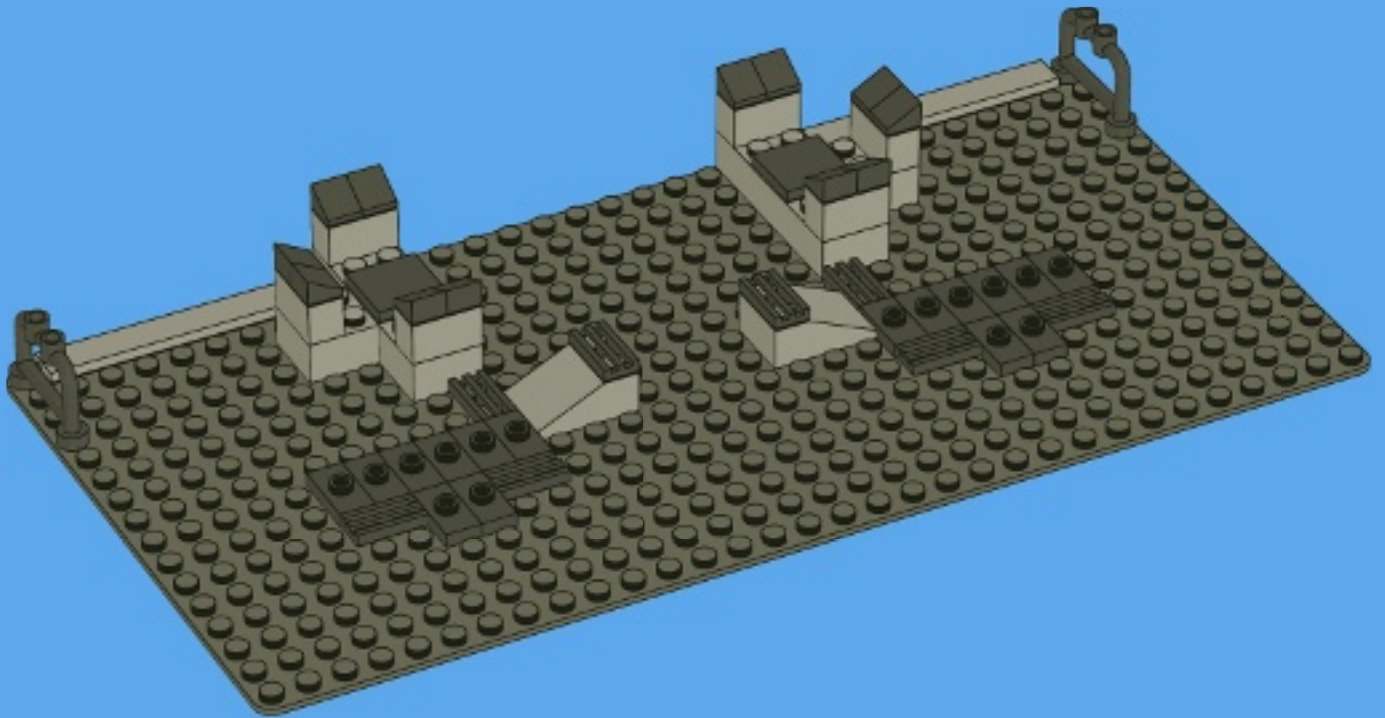

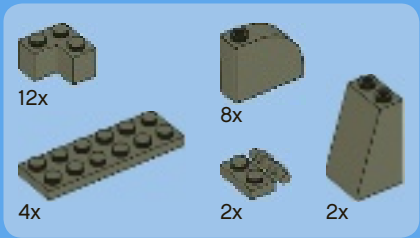

6

1



2

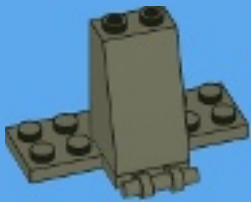

3

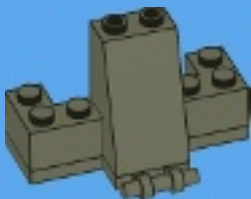

4

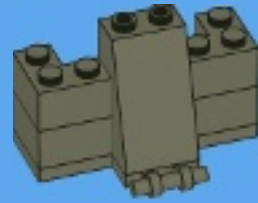

5



6



7



2x

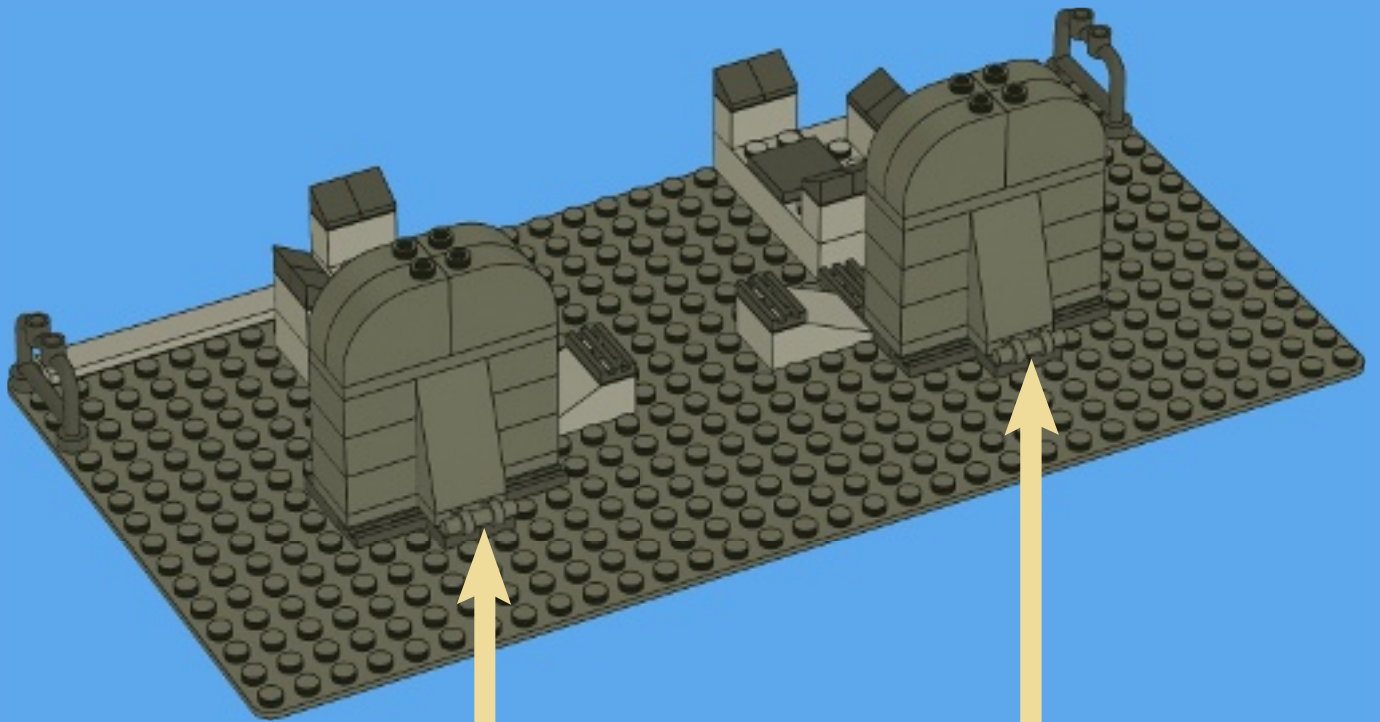

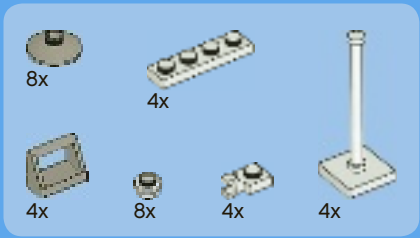

7

1



2

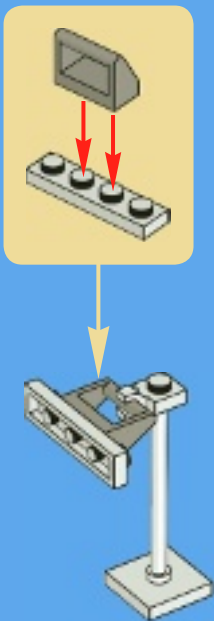

3

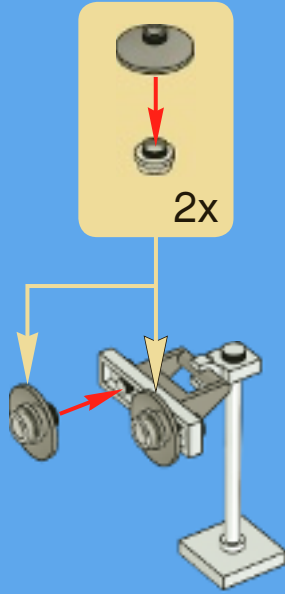

4



4x

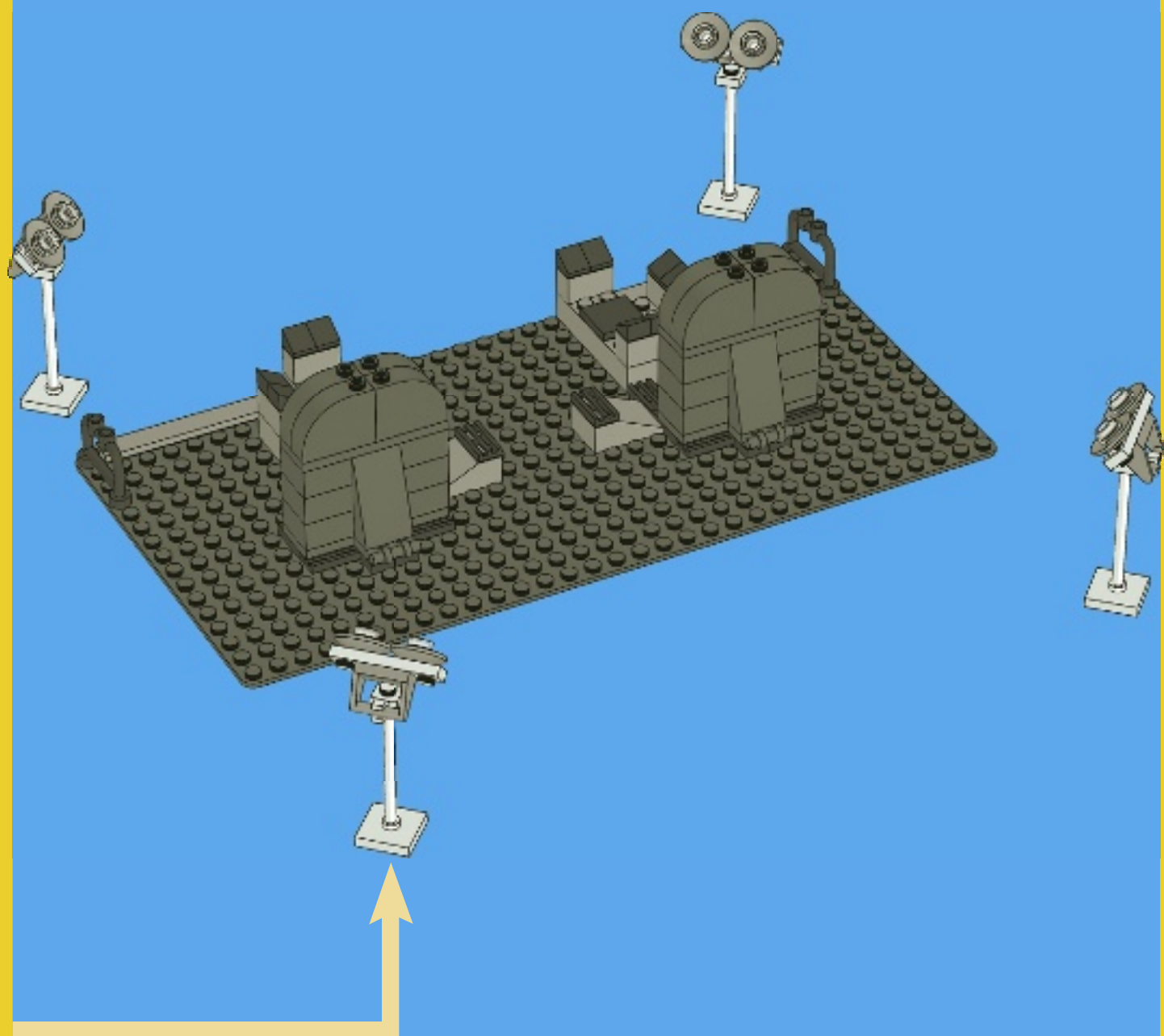

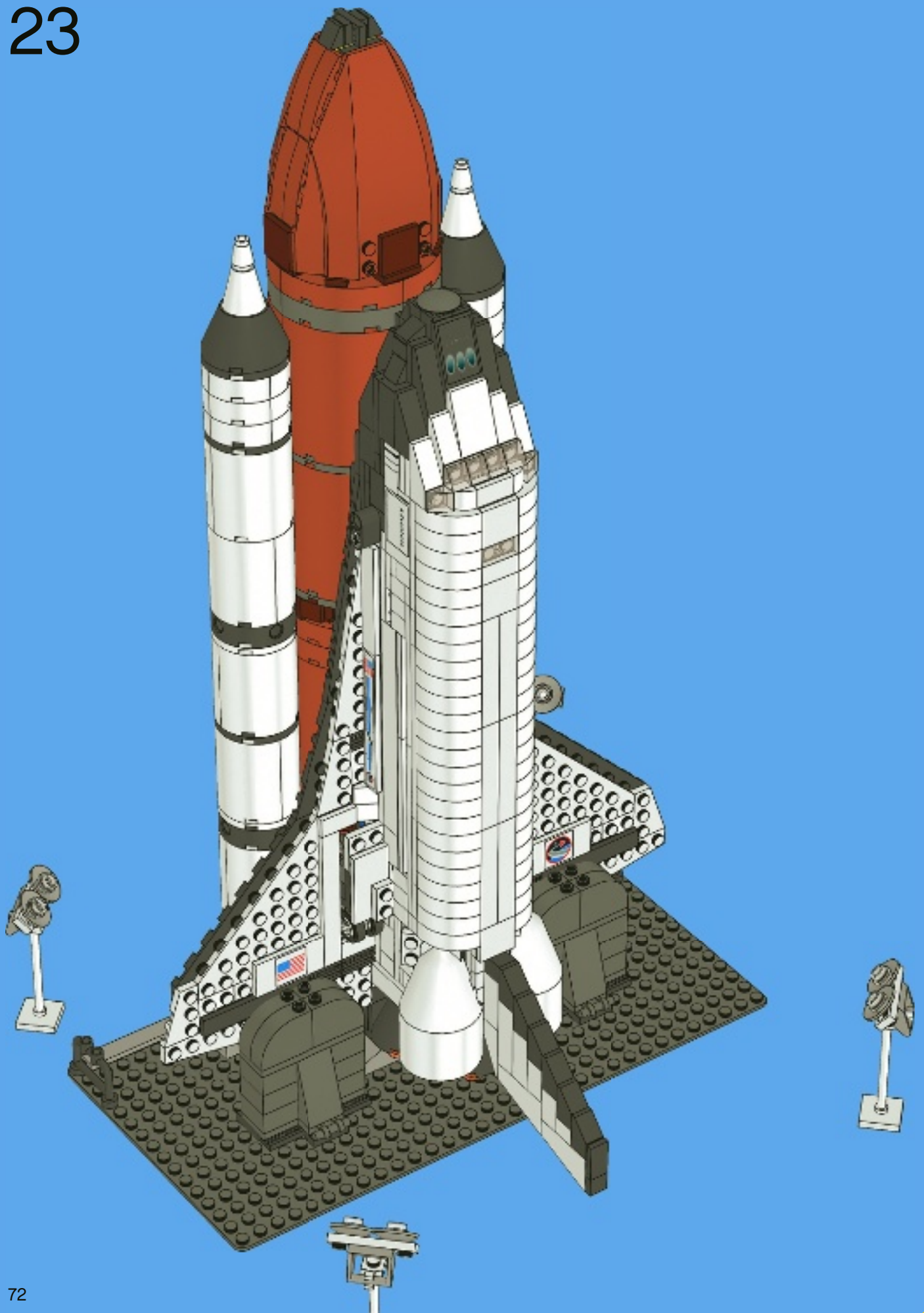

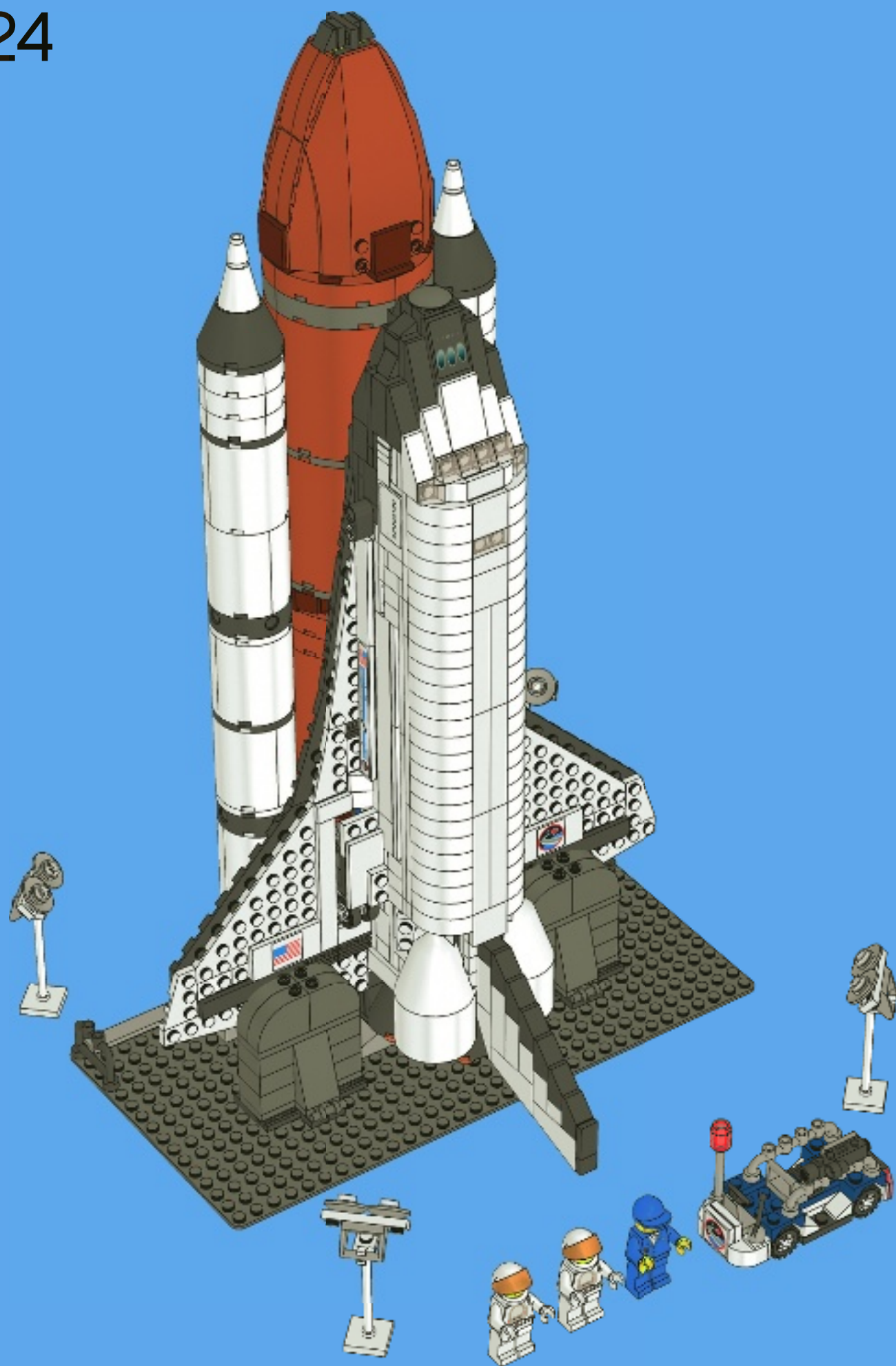

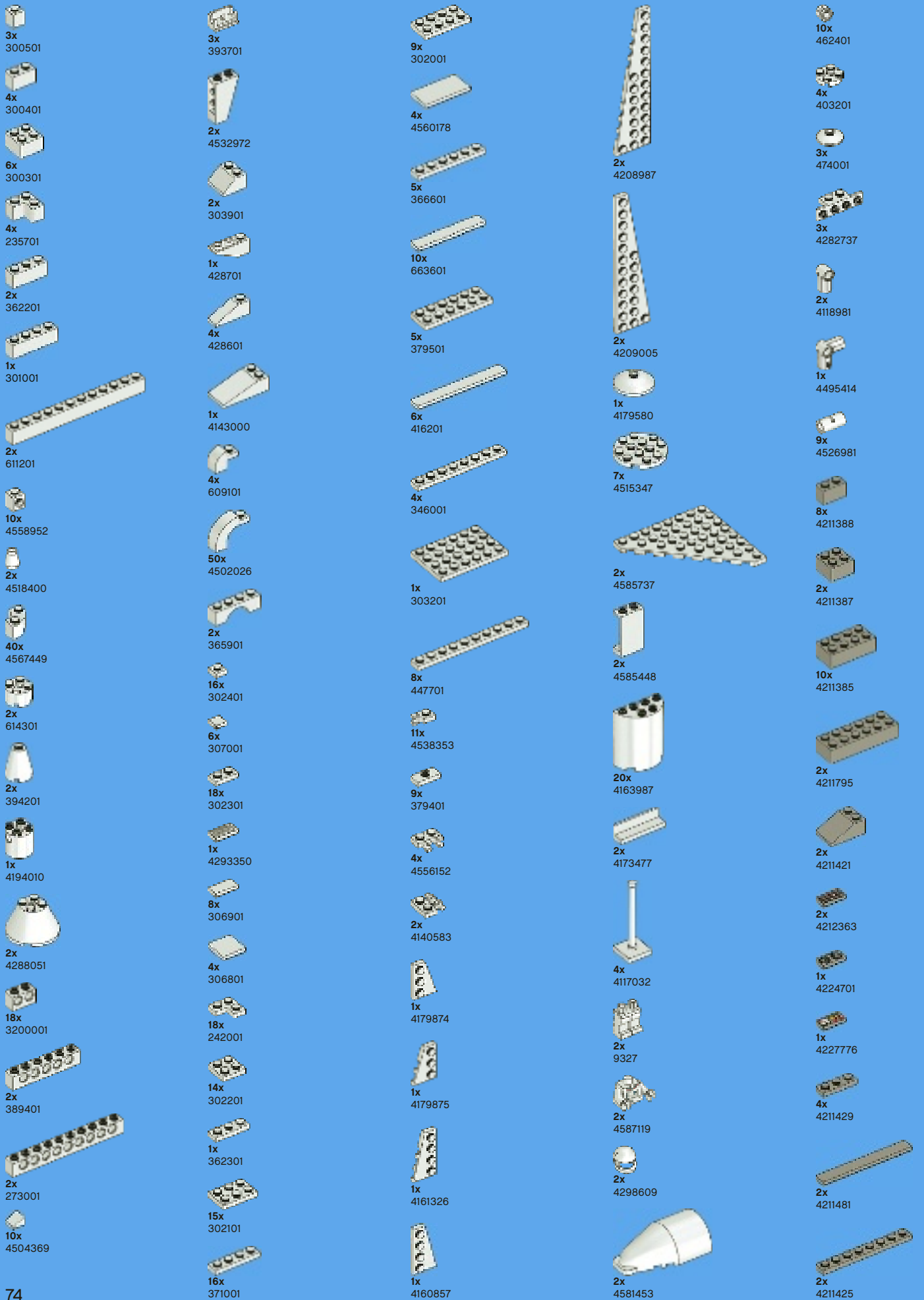



1x 4211408
 2x 4514846
 2x 4211516
 2x 4211840
 6x 4211525
 1x 4221881
 8x 4211512
 4x 4515351
 5x 4211357
 2x 4211524
 1x 4221775
 1x 4211473
 1x 4519013
 1x 4226995
 1x 4520320
 1x 4211815
 2x 4211639

2x 4262786
 2x 302324
 4x 4256320
 1x 4193511
 1x 4261572
 1x 4506830
 1x 4261269
 4x 4239601
 2x 4142622
 5x 300526
 2x 300426
 3x 4113241
 2x 300226
 16x 407026
 5x 4233487
 4x 614326
 2x 371026
 8x 302026
 2x 362326
 6x 302126

2x 366626
 3x 663626
 2x 379526
 2x 408126
 4x 4515340
 17x 379426
 30x 241226
 1x 4569733
 2x 395626
 1x 4114689
 2x 4106347
 4x 486526
 2x 408326
 4x 4124096
 1x 436026
 4x 4501046
 6x 4516843
 1x 244126

1x 256926
 1x 4213374
 5x 4515185
 2x 4107783
 2x 4107085
 11x 4121715
 11x 4512363
 1x 303226
 1x 395826
 2x 447726
 2x 383226
 2x 4514845
 2x 428226
 3x 370526
 1x 370726
 3x 373726
 2x 4233937

4x 4205347
 2x 4550190
 6x 4515350
 2x 4209013
 2x 4209003
 1x 4283046
 1x 4283047
 1x 4160869
 1x 4161332

3



















































5

4

8

10

32

-  2x
394226
-  3x
4500978
-  4x
4290056
-  2x
4550922
-  20x
4504382
-  6x
4121966
-  4x
428726
-  2x
428626
-  2x
4515362
-  1x
4185583
-  1x
307026
-  4x
306926
-  27x
302326
-  5x
306826
-  4x
302226
-  2x
242026
-  2x
4505182
-  4x
242023
-  2x
408523
-  1x
370923
-  3x
4114027
-  1x
9341
-  1x
4287488
-  1x
4567909
-  2x
4168114
-  8x
4186834
-  15x
4143005
-  3x
4206482
-  4x
4514553
-  22x
3005747
-  6x
4244368
-  1x
4529685
-  2x
4566927
- 9x
3005740
-  1x
3006841
-  2x
4244363
-  2x
4508534
-  24x
4582989
-  8x
4582992
-  2x
4582987
-  2x
4582984
-  2x
4582991
-  12x
4582990
-  2x
4210696
-  8x
4210913
-  3x
4243831
-  4x
421002
-  2x
4210660
-  3x
4211042
-  1x
4278274
-  1x
4210865
- 12x
4222042
- 1x
4268409
- 2x
4210753
- 2x
4560177
- 1x
4508553
- 14x
4211109
- 1x
4225975
- 8x
4535931
- 3x
4547958
- 2x
4530028
- 2x
4565227
- 2x
4504379
- 6x
4277933
- 4x
4515365
- 2x
403221
- 1x
393821
- 2x
4227155
- 17x
4142865
- 4x
4513174
- 2x
4211210
- 18x
4225469
- 6x
4211183
- 12x
4211252
- 16x
4504376
- 16x
4221744
- 4x
4211288
- 4x
4211151
- 4x
4271949
- 6x
4514554

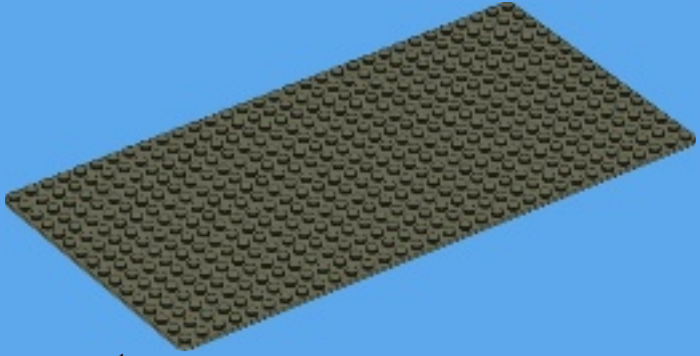

1x
4269651

 **Customer Service**
Kundenservice
Service Consommateurs
Servicio Al Consumidor
www.lego.com/service or dial

00800 5346 5555 :        

1-800-422-5346 :  



10197

10211

10185

1.
Enter
Homepage



DESIGN by ME



2.
Install LEGO®
Digital Designer



3.
Build your
dream model



4.
Design your
own box



Designbyme.LEGO.com



5.
Order your
custom set

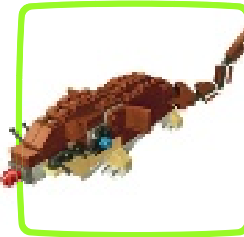

DREAMT byME

BUILT byME

DESIGN byME



WIN!

Go to www.nielsen.com/LEGO
to fill out a survey for a chance
to win a cool LEGO® Product.
No purchase necessary.
Open to all residents where not prohibited.

 www.LEGO.com



www.nielsen.com/LEGO

GEWINNE!

Nimm an der Umfrage auf www.nielsen.com/LEGO teil und hab die Chance ein cooles LEGO® Produkt zu gewinnen!

Die Teilnahme am Gewinnspiel führt zu keinerlei Kaufverpflichtungen. Teilnahme in allen nicht ausgeschlossenen Ländern möglich.

4620158

WIN!

Ga naar www.nielsen.com/LEGO, vul een enquêteformulier in en maak kans op een cool LEGO® product.

Geen aankoopverplichting.
Iedereen mag deelnemen, uitgezonderd ingezetenden van landen waar een enquêteverbod geldt.

GAGNE !

Visite www.nielsen.com/LEGO pour répondre à un questionnaire et avoir une chance de gagner un produit LEGO® très cool !

Aucune obligation d'achat.
Ouvert à tous les résidents des pays autorisés.

当てよう!

www.nielsen.com/LEGOにアクセスして、アンケートにご記入ください。当選者にはレゴ®製品を差し上げます。

お買い上げの必要はありません。
禁止されていない限り、すべての皆様にご利用いただけます。