



Friends



41130



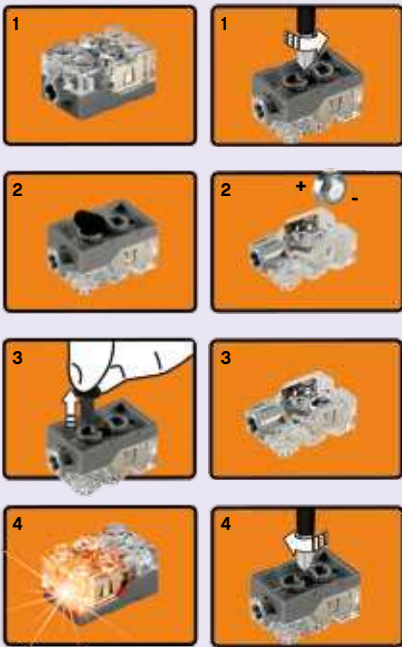

1:1
2x LR 41 1.5V

EN

Important information about batteries

Never use different types of batteries together, or a combination of old and new batteries. Always remove the batteries if the product is not to be used for a long time or if the batteries have run down. Never use damaged batteries. Only use batteries of the type recommended, or a corresponding type. Insert the batteries so that the poles are correctly positioned. Rechargeable batteries must be recharged using the correct battery charger under the supervision of an adult. You cannot recharge batteries while they are still in the product, and you must never try to do so. Never attempt to recharge non-rechargeable batteries. Never short-circuit the battery holder.

DE

Wichtige Informationen zu Batterien

Benutzen Sie niemals unterschiedlich Arten von Batterien oder alte und neue gleichzeitig. Nehmen Sie stets die Batterien heraus, wenn mit dem Modell längere Zeit nicht gespielt wird oder wenn die Batterien leer sind. Verwenden Sie niemals beschädigte Batterien. Verwenden Sie ausschließlich empfohlene bzw. geeignete Batterien. Achten Sie beim Einsetzen der Batterien auf die richtige Polung. Wiederaufladbare Batterien sollten mit einem geeigneten Ladegerät aufgeladen werden - unter der Aufsicht eines Erwachsenen. Wiederaufladbare Batterien können und sollten niemals aufgeladen werden, während sie sich im Modell befinden. Versuchen Sie unter keinen Umständen, „normale“ Batterien wieder aufzuladen. Schließen Sie das Batteriefach niemals kurz.

FR

Informations importantes concernant les piles

Ne jamais utiliser un mélange de différents types de piles, ou de piles neuves et de piles anciennes ou déjà utilisées. Toujours retirer les piles si le produit n'est pas utilisé durant une période prolongée ou si les piles sont vides. Ne jamais utiliser de piles endommagées. Utiliser uniquement des piles du type recommandé ou d'un type équivalent. En insérant les piles, respecter scrupuleusement le sens d'orientation des pôles (+/-). Les piles rechargeables doivent être rechargées en utilisant un chargeur de piles adéquat et sous la surveillance d'un adulte. Il est impossible de recharger les piles quand elles sont installées dans le produit. Ne jamais tenter de le faire. Ne jamais essayer de recharger des piles non-rechargeables. Ne jamais court-circuiter le compartiment des piles.

IT

Importanti informazioni sulle batterie

Non usare mai contemporaneamente batterie di tipo diverso o batterie nuove e usate insieme. Rimuovere sempre le batterie qualora il prodotto non venga utilizzato per periodi prolungati, oppure se le batterie sono esauste. Non utilizzare mai batterie danneggiate. Usare esclusivamente batterie del tipo raccomandato o un equivalente. Inserire le batterie avendo cura che la loro polarità sia corretta. Le batterie ricaricabili vanno ricaricate in un caricabatterie di tipo idoneo e con la supervisione di un adulto. Non è possibile e non bisogna mai tentare di ricaricare le batterie mentre queste sono inserite nel prodotto. Non tentare mai di ricaricare batterie non ricaricabili. Non cortocircuitare mai il portabatterie.

NL

Belangrijke informatie over batterijen

Gebruik nooit verschillende soorten of een combinatie van oude en nieuwe batterijen tegelijkertijd. Verwijder de batterijen altijd als je het product lange tijd niet wilt gebruiken of als batterijen leeg zijn. Gebruik nooit beschadigde batterijen. Gebruik uitsluitend batterijen van het aanbevolen type of een overeenkomstig type. Plaats de batterijen met de polen in de juiste richting. Opladbare batterijen moeten in een voor dit doel bestemde oplader en onder toezicht van een volwassene opnieuw worden opgeladen. Opladbare batterijen kunnen niet worden opgeladen terwijl ze zich nog in het product bevinden en dit mag ook nooit worden geprobeerd. Probeer nooit niet-oplaadbare batterijen opnieuw op te laden. Laat de batterijhouder nooit kortsluiten.

ES

Información importante acerca de las pilas

No use pilas de diferentes tipos ni pilas nuevas y antiguas para alimentar el producto. Extraiga las pilas del producto si este va a permanecer sin uso durante un período prolongado de tiempo o aquellas se han agotado. No use pilas dañadas. Use sólo pilas del tipo recomendado u otro equivalente. Inserte las pilas de modo que los polos queden situados en las posiciones correctas. La carga de pilas recargables debe tener lugar empleando un cargador apropiado y bajo la supervisión de un adulto. Las pilas recargables no se pueden cargar mientras permanecen insertadas en el producto; no intente hacerlo. No trate de cargar pilas no recargables. No cortocircuite el compartimento de las pilas.

DA

Vigtige oplysninger om batterier

Brug aldrig forskellige batterityper sammen eller en kombination af gamle og nye batterier. Fjern altid batterierne, hvis produktet ikke skal bruges i lang tid, eller hvis batterierne er flade. Brug aldrig beskadigede batterier. Brug kun den anbefalede type batterier eller en tilsvarende type. Sæt batterierne i, så polerne vender den rigtige vej. Genopladelige batterier skal oplades i den rigtige batterioplader. Batterierne skal sættes i opladeren under opsyn af en voksen. Batterierne kan ikke oplades, mens de stadig sidder i produktet, og man må aldrig forsøge at gøre det. Forsøg aldrig at oplade ikke-genopladelige batterier. Kortslut aldrig batteriholderen.

IS

Mikilvægar upplýsingar um rafhlöður

Aldrei skal nota mismunandi gerðir rafhlöðna samtímis, né nýjar og eldri rafhlöður samtímis. Ef ekki á að nota tækið í lengri tíma eða ef rafhlöðurnar eru orðnar tómar skal fjarlægja rafhlöðurnar. Aldrei skal nota rafhlöður sem hafa skemmt. Aðeins skal nota rafhlöður af þeirri gerð sem mælt er með, eða samsvarandi gerð. Setja skal rafhlöðurnar í þannig að +- og -skaut þeirra snúi rétt. Endurhláðanlegar rafhlöður skal endurhláða með réttu hleðslutæki undir eftirliti fullorðinna. Rafhlöður er ekki hægt að endurhláða á meðan þær eru enn í vörnni og það má aldrei reyna að gera það. Aldrei skal reyna að endurhláða rafhlöður sem ekki eru endurhláðanlegar. Aldrei ætti að valda skammhlaupi í rafhlöðuhöfnu.

FI

Tärkeää tietoa paristoista

Älä koskaan käytä erityyppisiä paristoja yhdessä. Älä myöskään käytä samassa laitteessa sekä vanhoja että uusia paristoja. Poista paristot tuotteesta aina, kun se on pitemmän aikaa käyttämättä, tai kun paristot ovat tyhjentyneet. Älä koskaan käytä viallisia paristoja. Käytä vain tuotteessa suositeltuja tai vastaavantyyppisiä paristoja. Aseta paristot siten, että navat osoittavat oikeaan suuntaan. Ladattavat paristot on ladattava oikeanlaisella laturilla aikuisen valvonnassa. Ne on poistettava tuotteesta lataamisen ajaksi. Älä koskaan yritä ladata paristoja, joita ei ole tarkoitettu ladattaviksi. Älä koskaan aiheuta oikosulkua pariston kosketinten välillä.

SV

Viktig information om batterier

Använd aldrig olika sorters batterier samtidigt, och inte heller en kombination av gamla och nya batterier. Ta alltid ur batterierna om produkten inte ska användas under en längre tid eller om batterierna är slut. Använd aldrig skadade batterier. Använd bara batterier av den typ som rekommenderas, eller av en motsvarande typ. Sätt i batterierna så att polerna hamnar i rätt läge. Laddningsbara batterier måste laddas med rätt slags batteriladdare och under en vuxens överinseende. Du kan inte ladda batterierna medan de fortfarande sitter i produkten, och du får heller aldrig försöka göra det. Försök aldrig ladda icke laddningsbara batterier. Kortslut aldrig batteriutrymmets kontaktytor.

NO

Viktig informasjon om batterier

Bruk aldri ulike typer batterier sammen og heller aldri gamle og nye batterier sammen. Ta alltid ut batteriene hvis produktet ikke skal brukes på lang tid, eller hvis batteriene er brukt opp. Bruk aldri skadde batterier. Bruk kun anbefalt type batterier eller tilsvarende type. Sett inn batteriene med polene vendt riktig vei. Opladbare batterier skal lades opp med riktig batterilader, under overoppsyn av en voksen. Det er ikke mulig å lade opp batteriene mens de fremdeles er i produktet, og du må aldri forsøke å gjøre det. Forsøk aldri å lade opp ikke-opladdbare batterier. Kortslett aldri batteriholderen.

PT

Informação importante sobre as pilhas

Nunca use diferentes tipos de pilhas em simultâneo, ou uma combinação de pilhas usadas e novas. Retire sempre as pilhas se o produto não for usado durante muito tempo ou se as pilhas já não tiverem carga. Nunca use pilhas danificadas. Use apenas pilhas do tipo recomendado ou de um tipo correspondente. Insira as pilhas de forma a que os pólos fiquem corretamente posicionados. As pilhas recarregáveis devem ser recarregadas com o carregador de pilhas correto e sob a supervisão de um adulto. Não pode recarregar as pilhas enquanto as mesmas se encontram colocadas no produto e nunca deve tentar fazê-lo. Nunca tente recarregar pilhas não recarregáveis. Nunca deixe o compartimento das pilhas entrar em curto-circuito.

EL

Σημαντικές πληροφορίες για τις μπαταρίες

Μην χρησιμοποιείτε ποτέ διαφορετικούς τύπους μπαταριών μαζί και μην συνδυάζετε παλιές και καινούργιες μπαταρίες. Αφαιρείτε πάντα τις μπαταρίες αν δεν σκοπεύετε να χρησιμοποιήσετε το προϊόν για αρκετό καιρό ή αν οι μπαταρίες έχουν αδειάσει. Ποτέ μην χρησιμοποιείτε μπαταρίες που έχουν φθορές. Χρησιμοποιείτε μόνο μπαταρίες του συνιστώμενου τύπου ή κάποιου αντίστοιχου τύπου. Τοποθετήστε τις μπαταρίες με τους πόλους στη σωστή θέση. Οι επαναφορτιζόμενες μπαταρίες πρέπει να επαναφορτίζονται χρησιμοποιώντας το σωστό φορτιστή μπαταριών υπό την επίβλεψη ενηλίκου. Δεν μπορείτε να επαναφορτίσετε τις μπαταρίες όταν αυτές βρίσκονται μέσα στο προϊόν και δεν πρέπει ποτέ να δοκιμάσετε κάτι τέτοιο. Μην επιχειρήσετε ποτέ να επαναφορτίσετε μη επαναφορτιζόμενες μπαταρίες. Ποτέ μην βραχυκυκλώνετε τη θήκη των μπαταριών.

JA

電池取扱いに関する重要事項

異なるタイプの電池や古い電池を混ぜて使用しないでください。商品を長時間使用しないときや電池が切れたときは、電池を必ず取り外してください。不具合のある電池は、絶対に使用しないでください。推奨されているタイプまたは対応しているタイプの電池を必ず使用してください。電極を確認して電池を正しい向きに入れてください。充電式電池は、保護者に見てもらった上で適切な充電器を使って充電してください。電池の商品の中にいれたまま充電することは絶対に避けてください。充電式ではない電池は絶対に充電しないでください。電池ホルダをショートさせないでください。

ZH

关于电池的重要信息

请勿同时使用不同类型的电池，或把新旧程度不同的电池混合使用。如果产品将有很长时间不会使用，或者电池已经没电，请注意取出电池。切勿使用已破损的电池。务必仅使用推荐类型或兼容类型的电池。装入电池时请注意正负极。如果使用充电电池，务必在成人监护下使用正确的电池充电器进行充电。电池仍在产品中时不可进行充电，请勿强行尝试充电。请勿尝试给非充电电池充电。切勿对电池仓进行短路连接。

KO

배터리 사용 시 주의사항

다른 종류의 배터리를 함께 사용하거나, 새 전지와 오래된 전지를 혼용하지 마세요. 배터리가 방전되었거나 장기간 제품을 작동하지 않을 때에는 반드시 배터리를 분리하세요. 파손된 배터리는 사용하지 마세요. 레고에서 권장하는 유형의 배터리만 사용하세요. 양극과 음극의 위치를 잘 맞춰서 넣으세요. 어른의 감독에 따라 지정된 충전기에 충전지를 충전해야 합니다. 충전지를 제품에 넣은 상태로 충전하면 안 됩니다. 일방 배터리는 충전해서 사용할 수 없습니다. 배터리 홀더의 접촉부에 배터리를 정확히 끼워서 사용하세요.



EN
Protect the environment by not disposing of this product with your household waste (2002/96/EC). Check with your local authority for recycling advice and facilities.

DE
Schützen Sie die Umwelt und entsorgen Sie dieses Produkt nicht mit Ihrem Hausmüll (2002/96/EC). Informationen zu Recycling-Möglichkeiten erhalten Sie bei den örtlichen Behörden.

FR
Protégez l'environnement : ne jetez pas ce produit avec vos autres déchets ménagers (Directive européenne 2002/96/EC). Contactez les autorités locales pour obtenir des informations sur le recyclage et connaître les points de collecte.

IT
Proteggi l'ambiente! Non smaltire questo prodotto con i rifiuti domestici (2002/96/EC). Per consulenza sul riciclaggio dei rifiuti e le strutture di riciclaggio, rivolgersi alle proprie autorità locali.

NL
Bescherm het milieu: gooi dit product niet samen met het andere huisvuil weg (2002/96/EC). Raadpleeg de plaatselijke instanties voor locaties van milieustations en advies over hergebruik.

ES
Proteja el medio ambiente no deshaciéndose de este producto junto con sus residuos domésticos (2002/96/CE). Solicite a su autoridad local consejos e información sobre instalaciones de reciclado.

DA
Beskyt miljøet! Smid ikke dette produkt ud sammen med husholdningsaffaldet (2002/96/EF). Få vejledning om genbrug og genbrugsstationer hos din kommune.

IS
Stuðlið að verndun umhverfis með því að farga þessari vöru ekki með heimilissorpi (2002/96/EB). Leitið upplýsinga um endurvinnslu- og förgunarstaði hjá staðaryfirvöldum.

FI
Tämä tuote on hävitettävä ympäristönsuojelun vuoksi asianmukaisesti talousjätteistä erillään (2002/96/EY). Tietoja keräyspisteiden sijainnista saa kunnan tai kaupungin teknisestä virastosta.

SV
Skydda miljön genom att inte kasta denna produkt bland ditt hushållsavfall (2002/96/EG). Kontakta din kommun för frågor om återvinning och miljöstationer.

NO
Beskytt miljøet. Ikke kast dette produktet i husholdningsavfallet (2002/96/EF). Kontakt kommunen for veiledning om gjenbruk og miljøstasjoner.

PT
Proteja o ambiente não eliminando este produto com o seu lixo doméstico (2002/96/CE). Consulte as autoridades locais para informação sobre reciclagem e sistemas de recolha.

EL
Προστατέψτε το περιβάλλον. Μην πετάτε αυτό το προϊόν μαζί με τα συνηθισμένα οικιακά απορρίμματα (2002/96/EC). Επικοινωνήστε με τις τοπικές αρχές σχετικά με συμβουλές και εγκαταστάσεις ανακύκλωσης.

JA
環境保護のため、本製品は家庭ごみとは別に処分してください (2002/96/EC)。リサイクルに関する指示や施設については、お住まいの地方自治体にお問い合わせください。

ZH
注意保护环境，请勿将本产品与家庭垃圾一起丢弃处理（2002/96/EC）。请咨询您当地相关部门，了解回收设施与回收建议。

KO
환경 보호를 위해 이 제품을 생활폐기물과 함께 버리지 마십시오(2002/96/EC). 재활용 방법 및 시설에 관한 사항은 현지 관계 당국에 문의하십시오.

RU
Защищайте окружающую среду, не утилизируйте этот продукт вместе с бытовым мусором (директива 2002/96/EC). Осведомитесь у местных органов власти о правилах вторичной переработки и утилизации таких отходов.

PL
Aby chronić środowisko naturalne, nie należy wyrzucać tego produktu wraz z odpadkami z gospodarstwa domowego (2002/96/WE). W celu uzyskania wskazówek dotyczących recyklingu oraz adresów zakładów należy skontaktować się z lokalnym urzędem.



CZ
Nevyhazujte tento produkt do domácího odpadu, chrňte životní prostředí (2002/96/EC). Zjistěte si prosím u místních úřadů možnosti recyklace a dostupná zařízení.

SK
Nevyhadzujte tento produkt do domáceho odpadu, chráňte životné prostredie (2002/96/EC). Zistite si prosím na miestnych úradoch možnosti recyklácie a dostupné zariadenia.

HU
Környezetét óvja, ha ettől a terméktől nem a háztartási hulladékkal együtt válik meg (2002/96/EC). Érdeklődjék a lakóhelyéhez közel eső hatóságnál az újrahasznosítás módjáról és lehetőségeiről.

UA
Допоможіть захистити довкілля: не утилізуйте цей виріб разом із побутовим сміттям (2002/96/EC). Вказівки з утилізації та відомості про пункти прийому з'ясуйте в місцевих компетентних органах.

HR
Zaštiti te okoliš tako da ovaj proizvod ne odložite u otpad zajedno s kućanskim otpadom (2002/96/EZ). Od lokalnih vlasti zatražite savjet ili informacije o pogonima za recikliranje.

SR
Zaštite životnu sredinu tako što nećete odlagati ovaj proizvod sa kućnim otpadom (2002/96/EC). Obratite se lokalnoj ovlašćenoj službi da biste dobili savete o recikliranju i saznali o objektima za reciklazu.

MK
Zaštite je okolinu tako što nemojte da se oslobodite od proizvoda sa domaćim otpadom (2002/96/EC). Konsultirajte se sa lokalnim vlastima da biste saznali savete i objekte za recikliranje.

SL
Zaščitite okolje! Okolje varujte tako, da tega izdelka ne zavržete skupaj z gospodinjiskimi odpadki (2002/96/ES). Pri krajevni upravi preverite, kakšne možnosti in kateri obrati za recikliranje obstajajo v vaši okolici.

RO
Protejați mediul înconjurător și nu vă debarașiți de acest produs împreună cu deșeurile menajere (2002/96/CE). Consultați autoritățile locale pentru îndrumări și facilități de reciclare.

BG
Защитете околната среда и не изхвърляйте този продукт заедно с битовите си отпадъци (2002/96/EO). Свържете се с местните власти относно съвети и съоръжения за рециклиране.

LV
Lai saudzētu vidi, neizmetiet šo izstrādājumu kopā ar sadzīves atkritumiem (2002/96/EK). Vērsieties vietējās varas iestādēs, lai noskaidrotu, kur un kā tas nododams pārstrādei.

ET
Keskonda saate kaitsta nii, et ei kõrvalda seda toodet koos olmejäätmetega (2002/96/EÜ). Nõuandeid toote taaskasutusse võtmise ja ümbertöötlemispunktide kohta saate asjaomaset kohalikult asutuselt.

LT
Saugokite aplinką – nemeskite šio produkto kartu su buitinėmis atliekomis (2002/96/EB). Atsižvelkite į savo vietos valdžios rekomendacijas dėl pakartotinio panaudojimo ir sąlygas.

TR
Bu ürünü, evsel atıklarla birlikte atmayarak çevreyi koruyun (2002/96/EC). Geri dönüşüm tavsiyeleri ve tesisler hakkında bilgi için yerel yönetimle iletişim kurun.

AR
ساهم في حماية البيئة عن طريق عدم التخلص من هذا المنتج مع المخلفات المنزلية. (CE/2002/96). استشر السلطة المحلية للتعرف على إرشادات ومرافق إعادة تدوير المخلفات.

ID
Jagalah lingkungan dengan tidak membuang produk ini bersama sampah rumah tangga Anda (2002/96/EC). Periksa peraturan pemerintah setempat tentang saran dan fasilitas daur ulang.

MS
Lindungi persekitaran dengan tidak melupuskan produk ini bersama dengan sisa isi rumah anda (2002/96/EC). Rujuk pihak berkuasa tempatan anda bagi nasihat dan kemudahan kitar semula.



LEGO.com/brickseparator

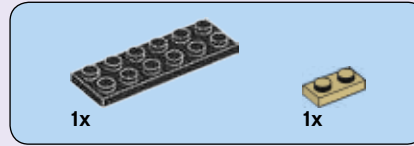
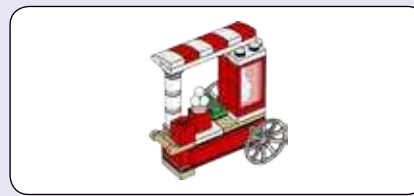
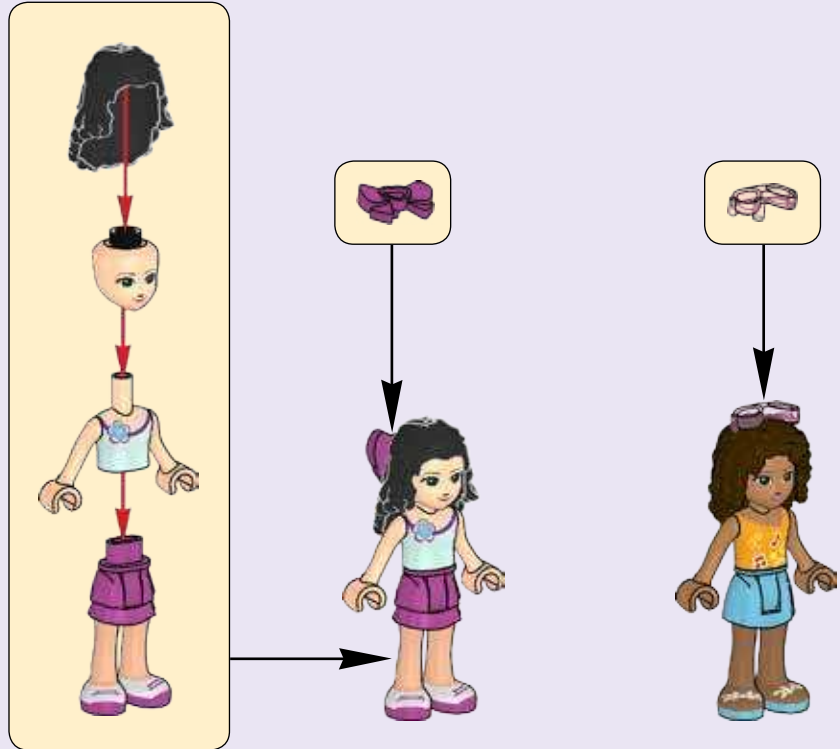
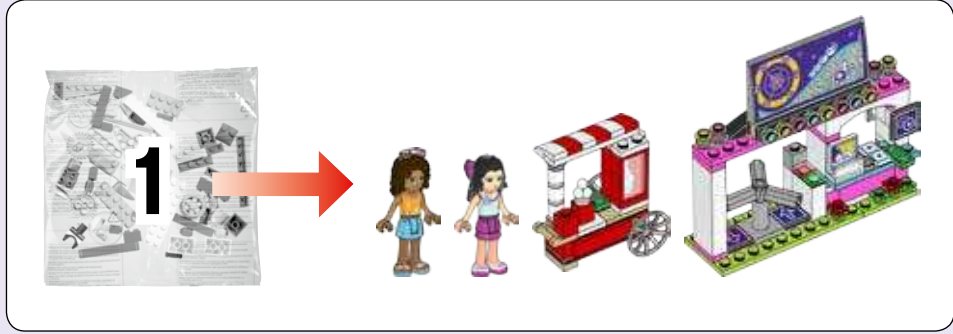

1

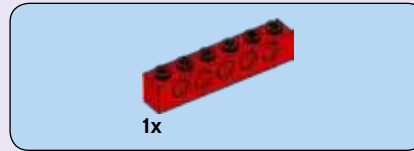
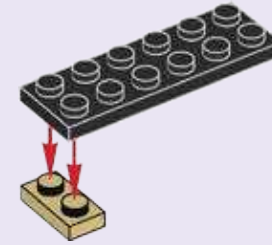

2

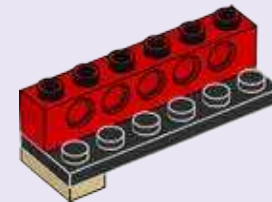

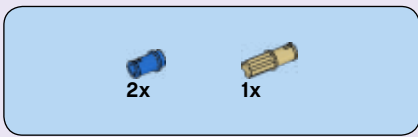

3

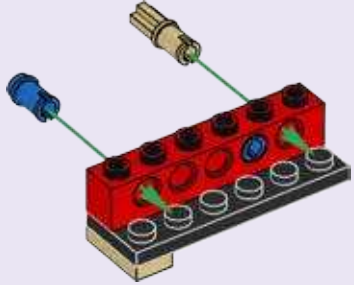

4

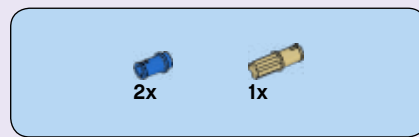
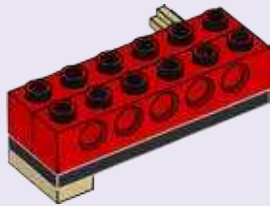

5

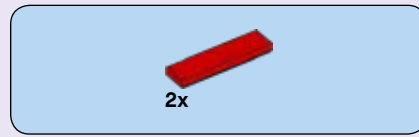
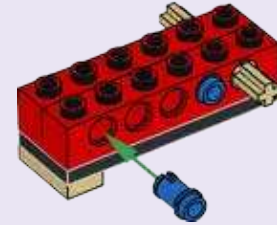

6

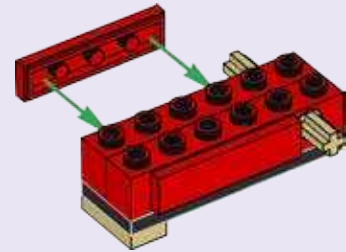



7



8

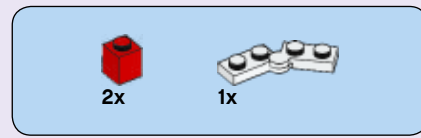
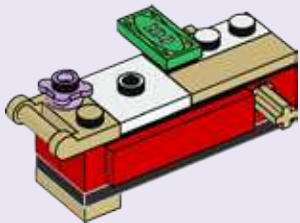

9

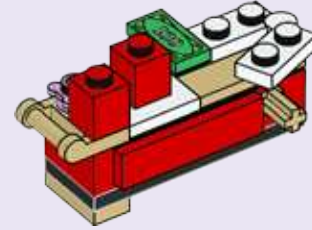

10

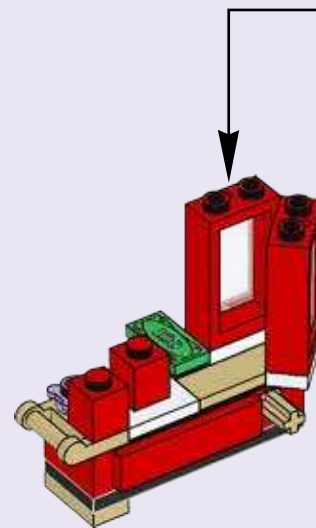
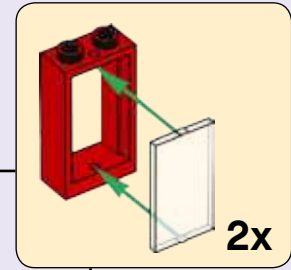

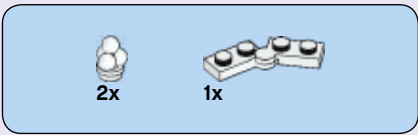

11

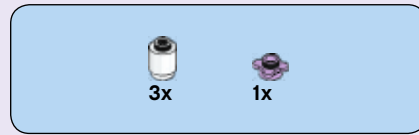
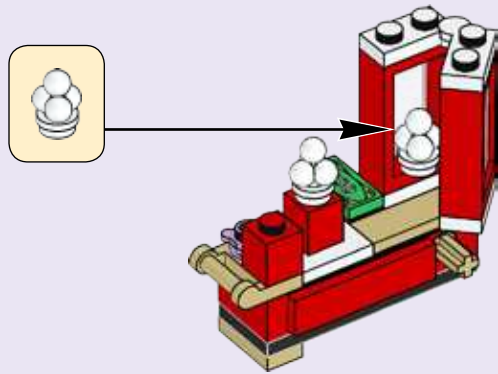

12

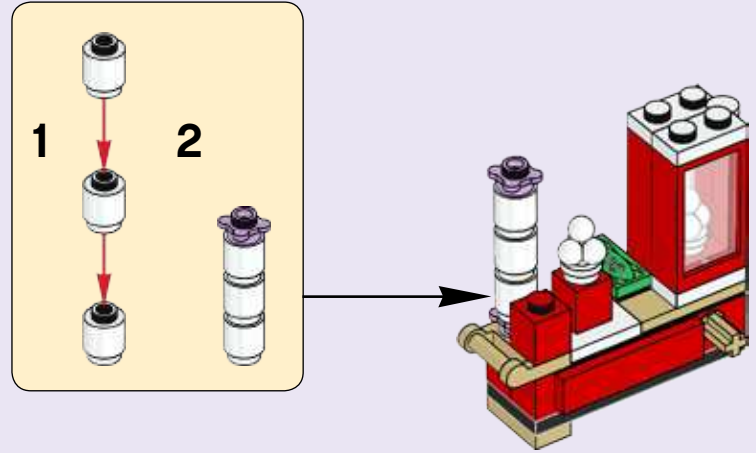

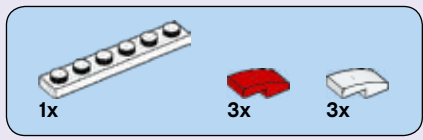

13

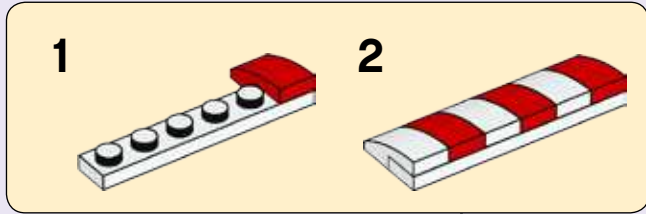

14



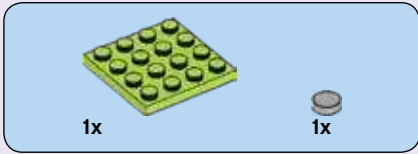
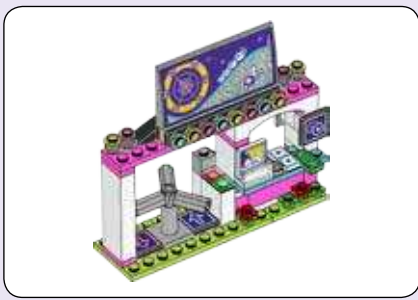

1

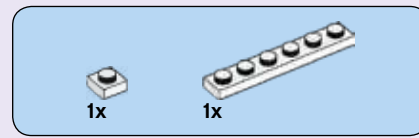
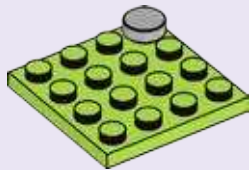

2

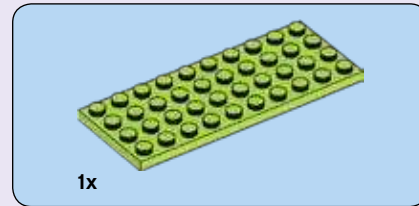
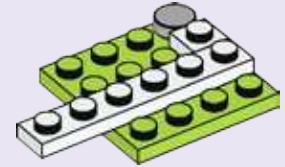

3

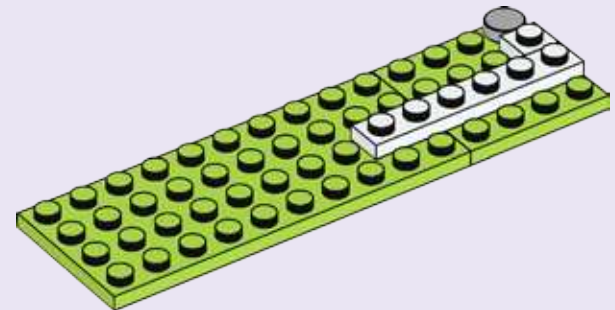

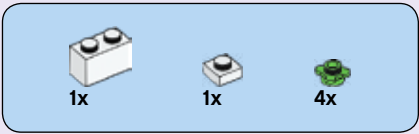

4

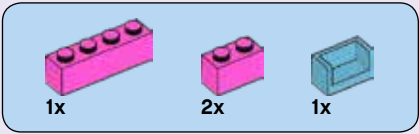
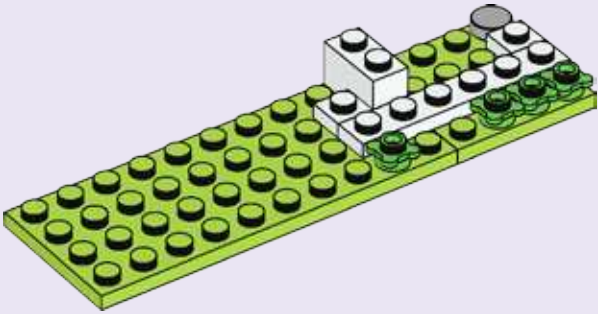

5

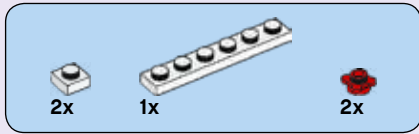
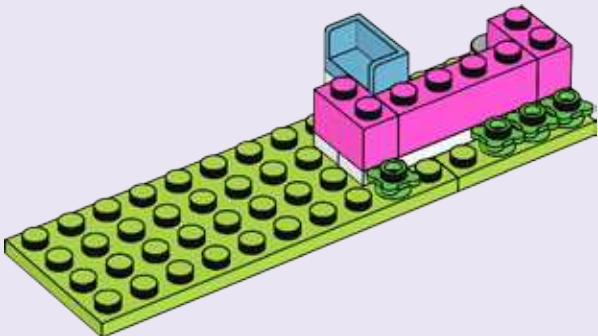

6

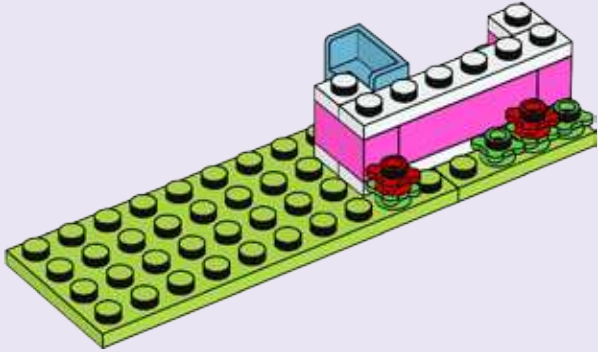

7

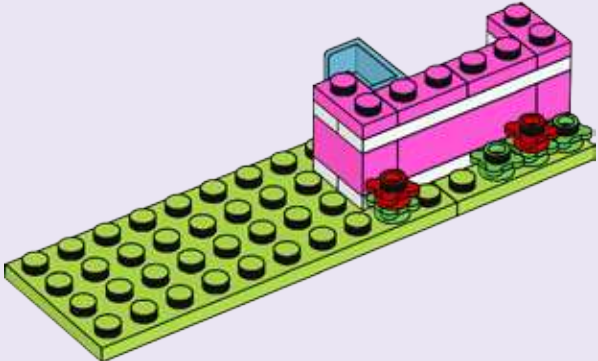



8

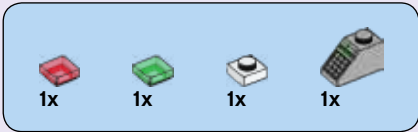
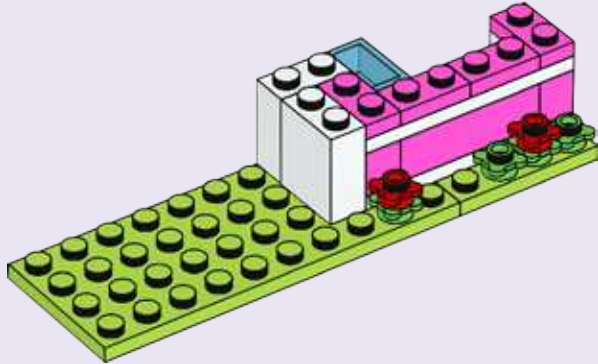

9

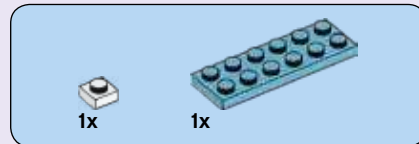
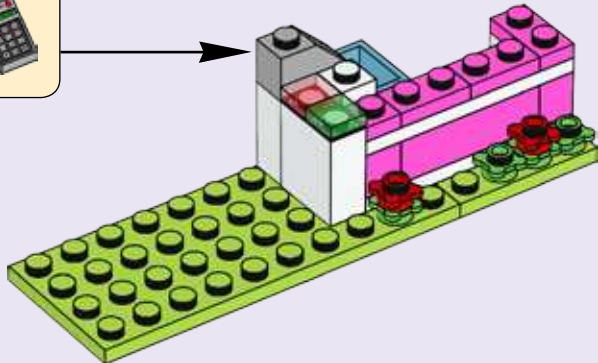

10

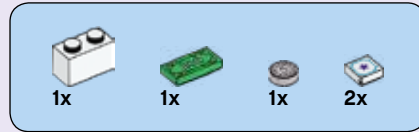
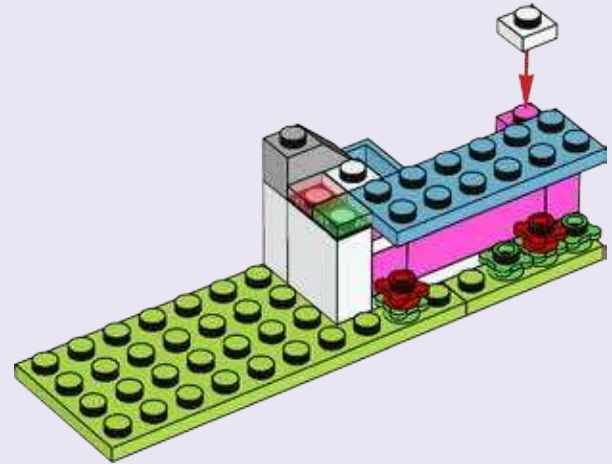

11

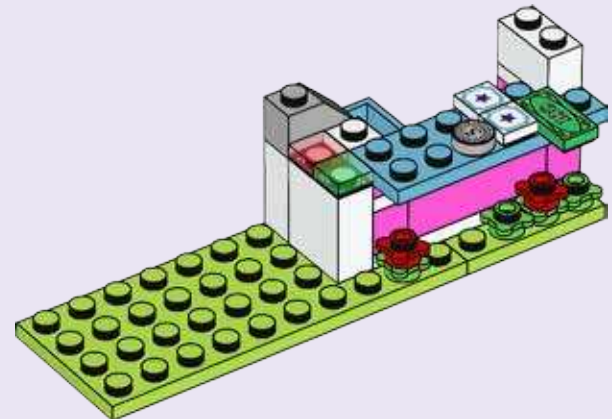

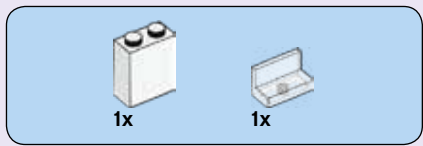

12

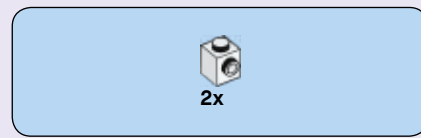
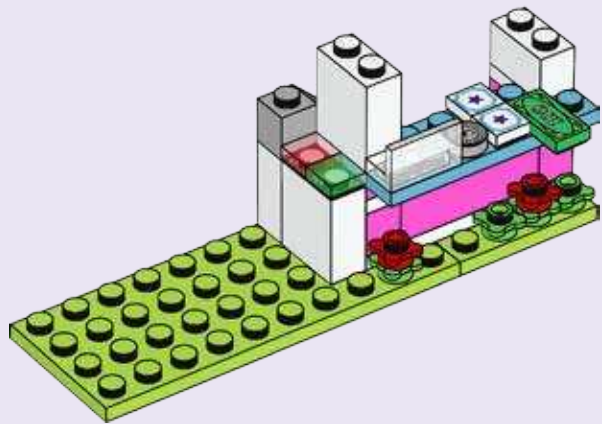

13

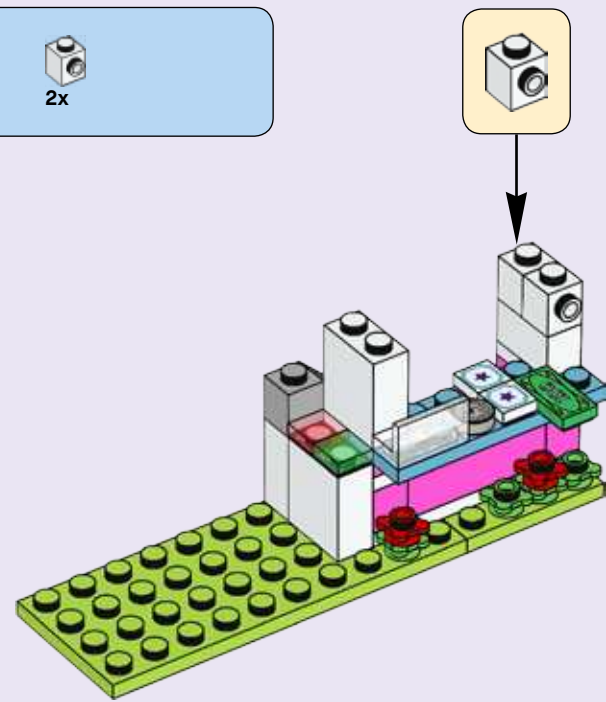

14

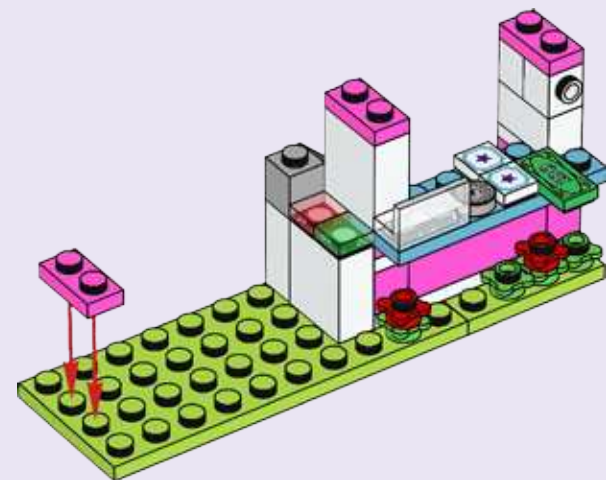

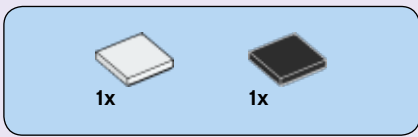

15

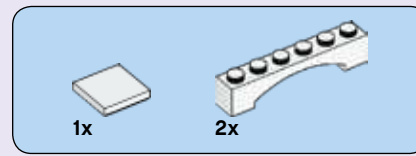
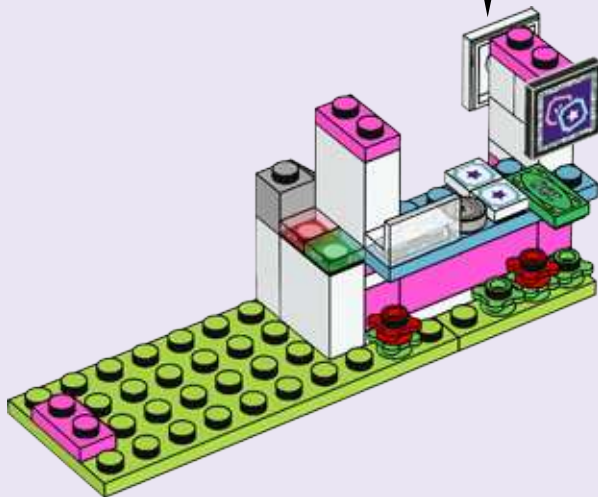
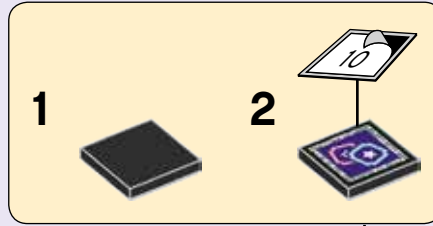
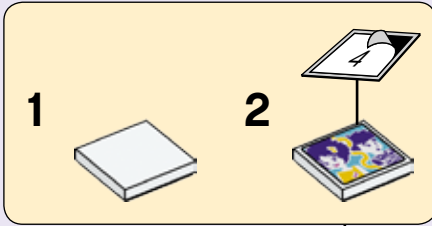

16

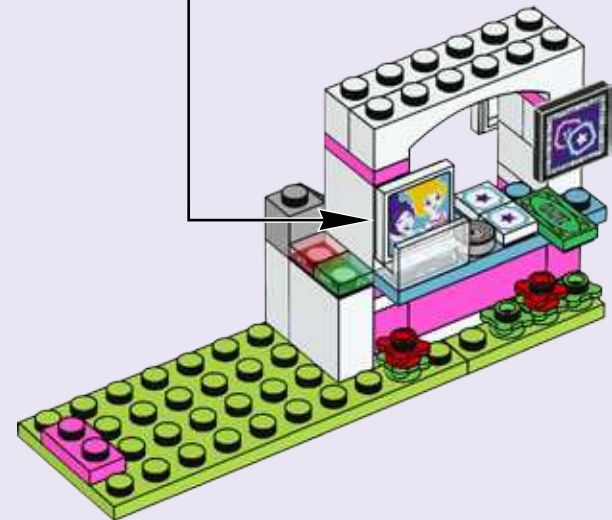
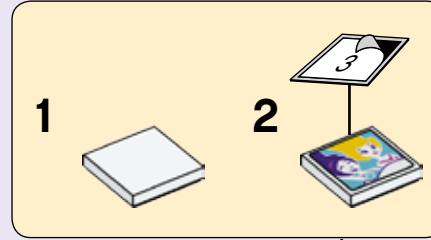

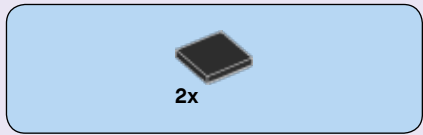

17

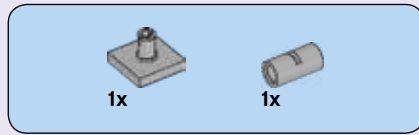
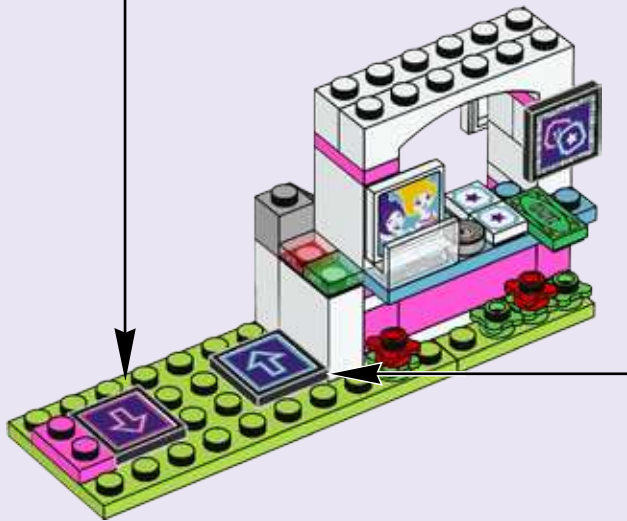
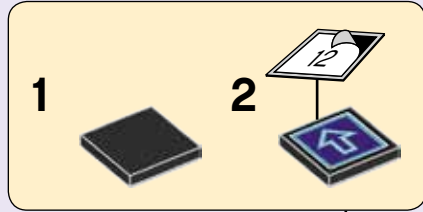
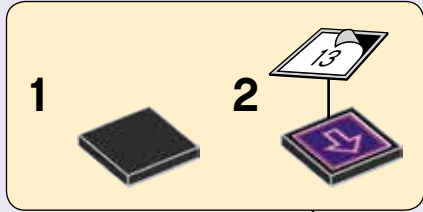

18

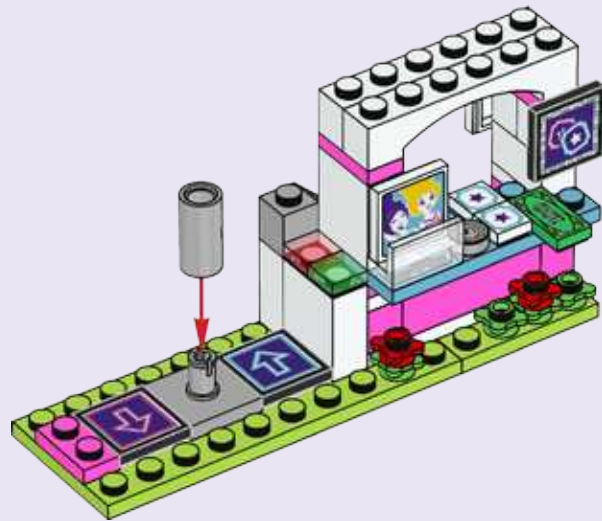



19

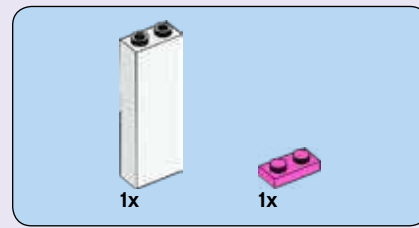
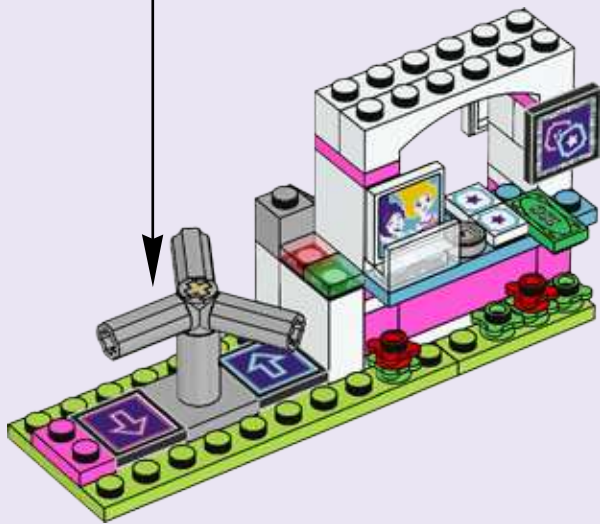
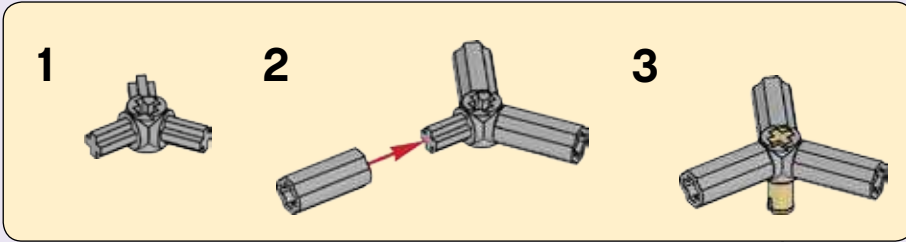

20

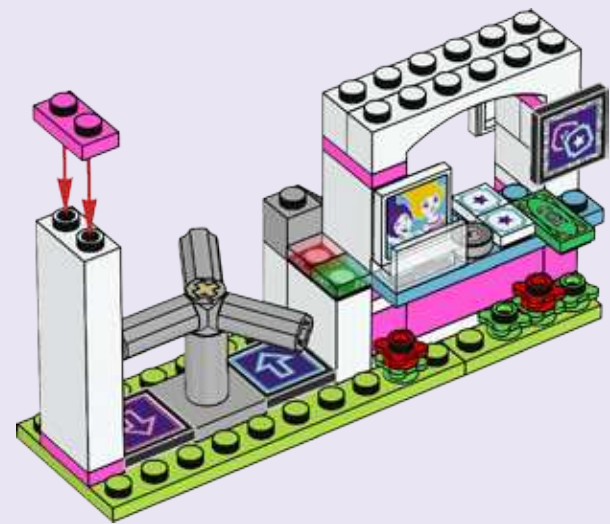

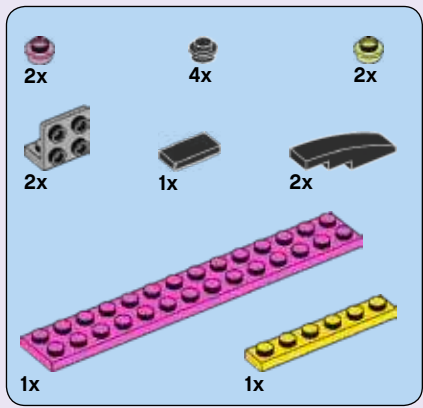

21

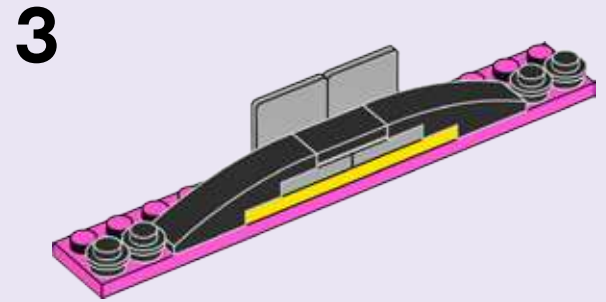
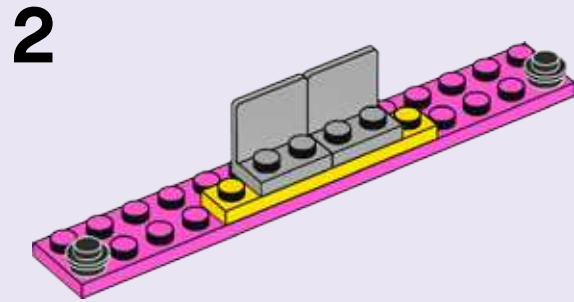
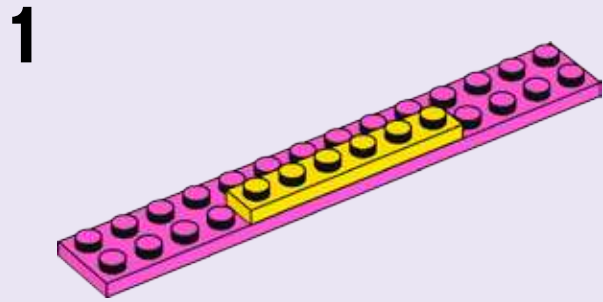

4

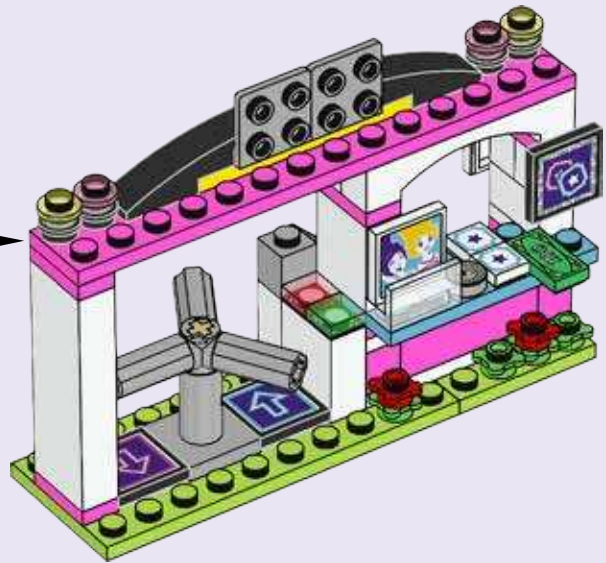
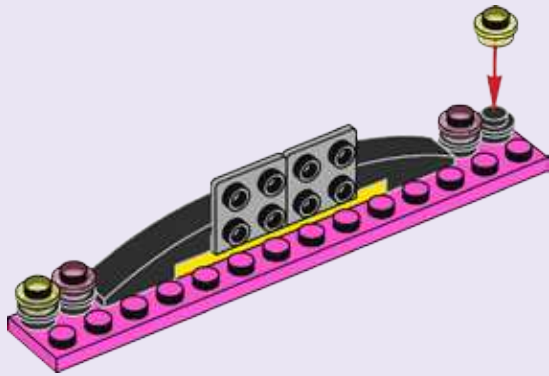
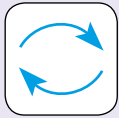

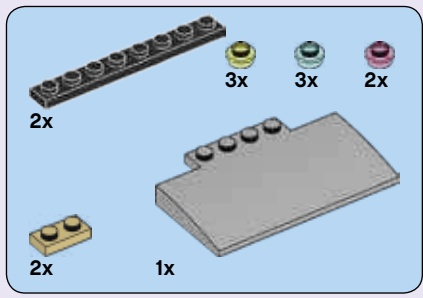

22

1

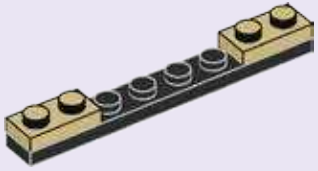

2

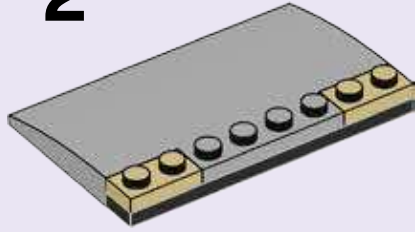

3

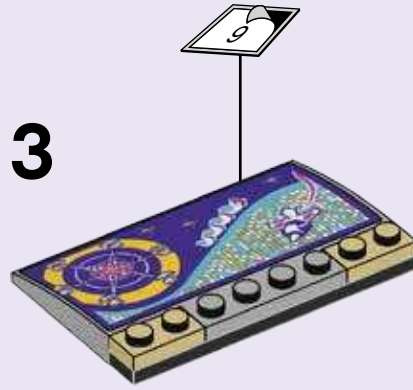

4



5



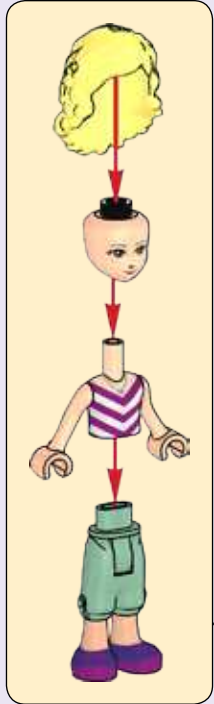
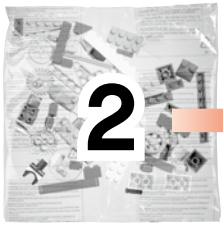

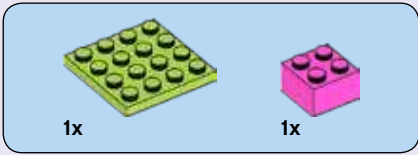

1

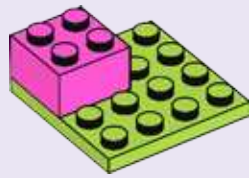

2

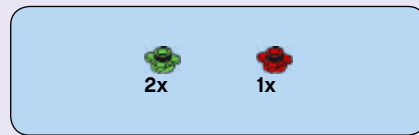
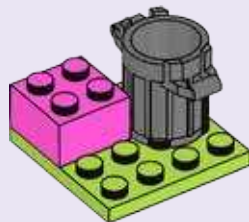

3

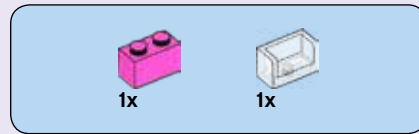
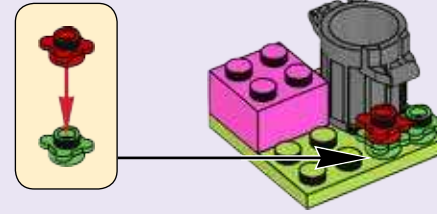

4





5

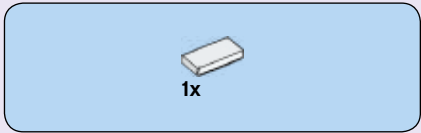

6

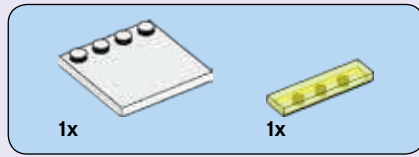
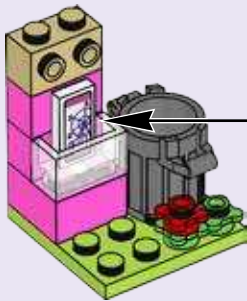
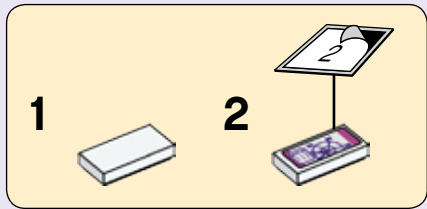

7

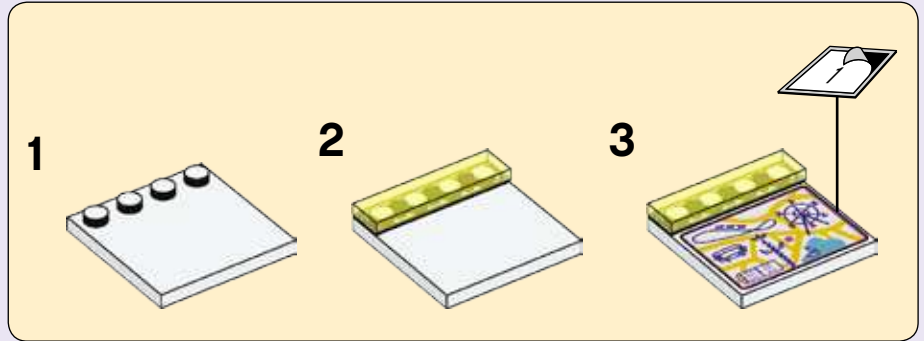

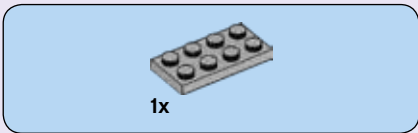
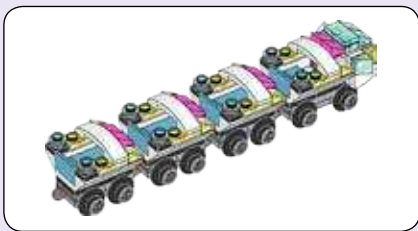

1x

1

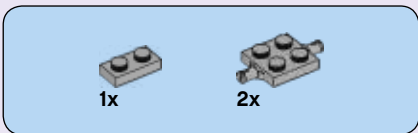
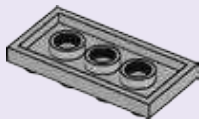

1x

2x

2

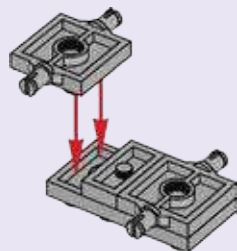

1x

3

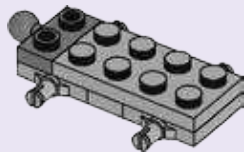
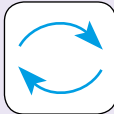

1x

1x

4

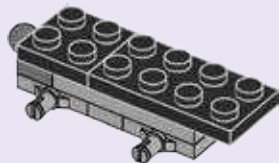

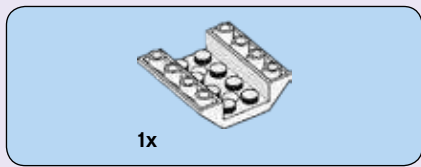

5

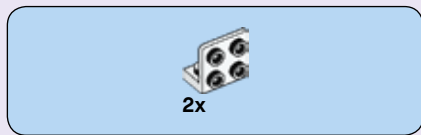
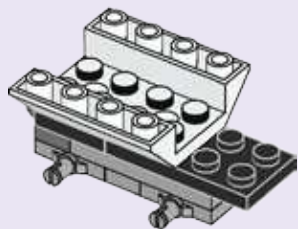

6

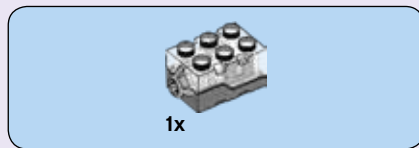
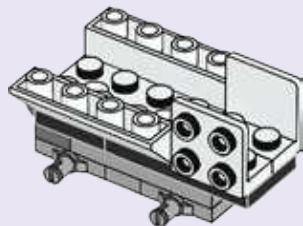

7

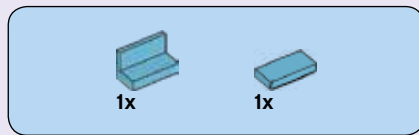
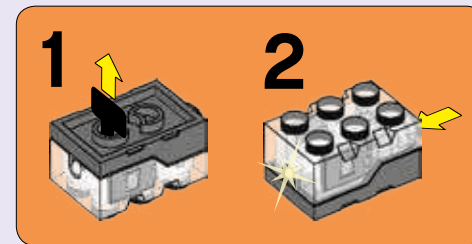
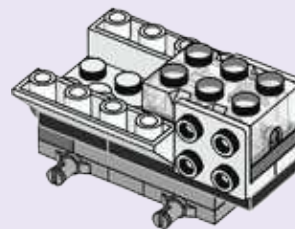

8

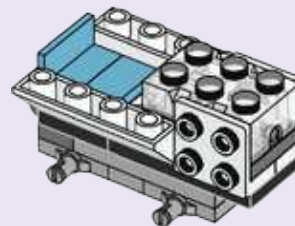

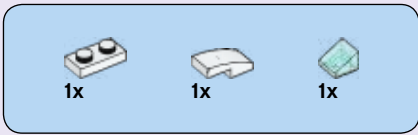

9

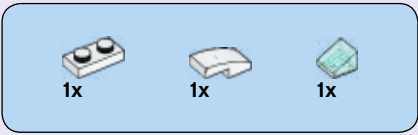
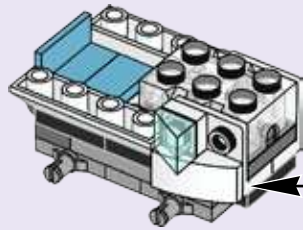
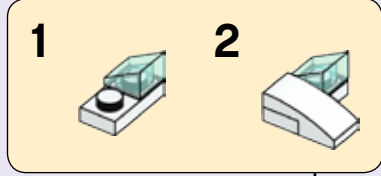

10

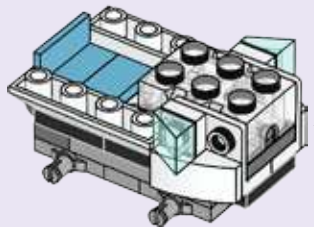
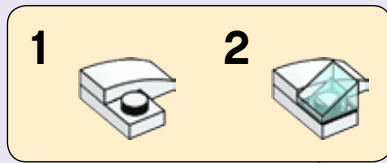

11



12



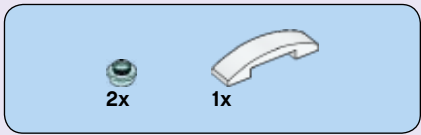

13

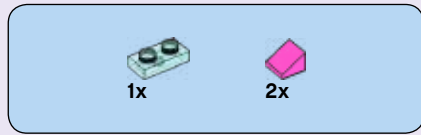
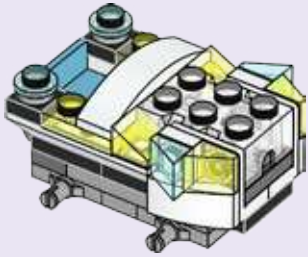

14

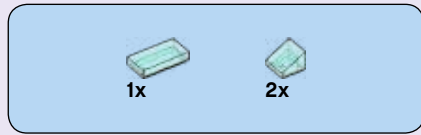
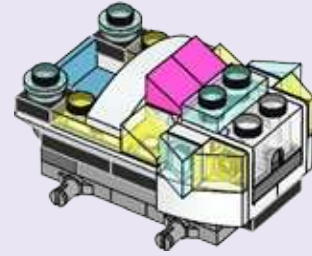

15

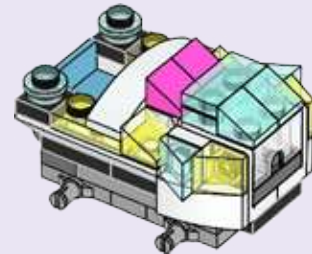

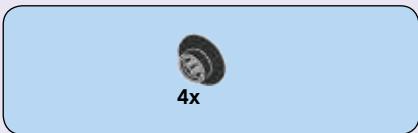

16

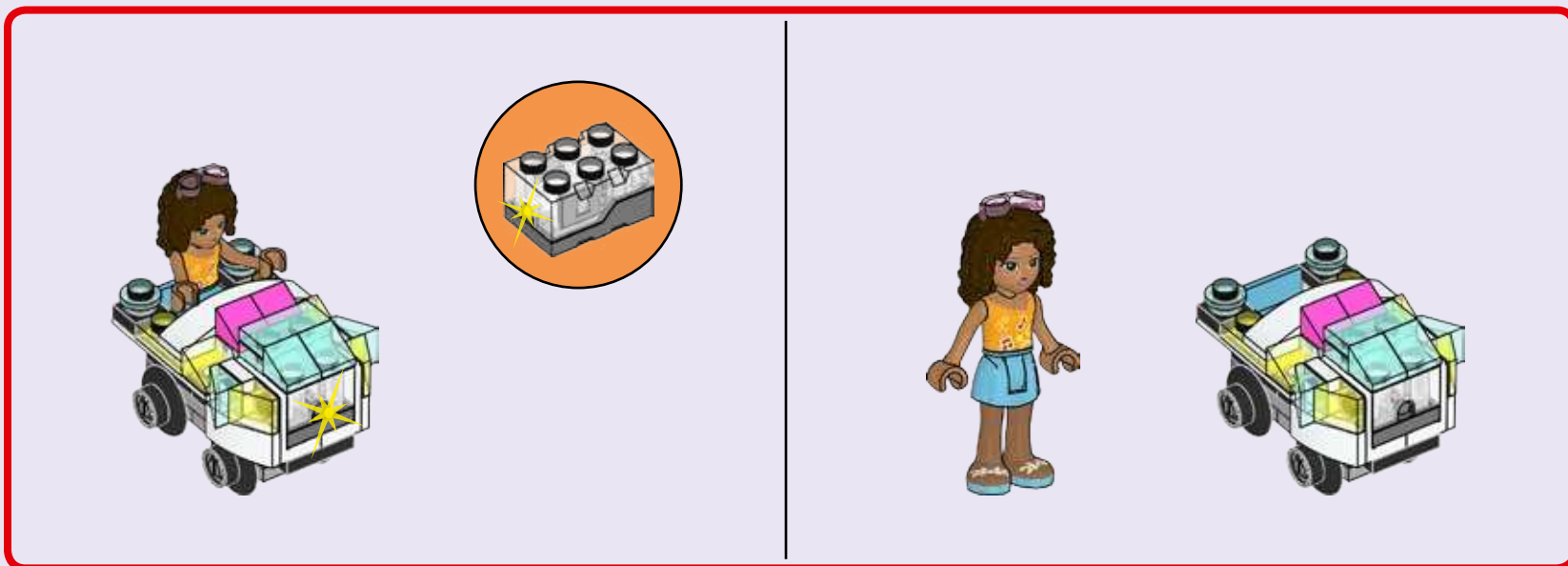
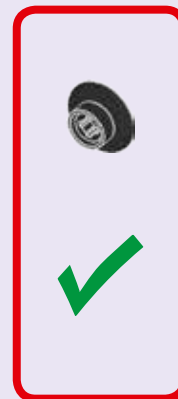
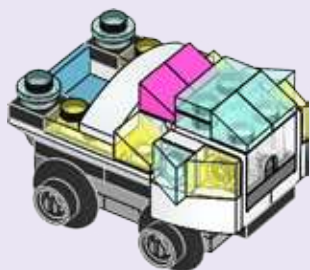



3x

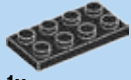

1x

17

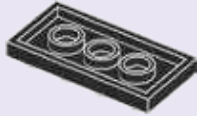

1x



1x



1x

18

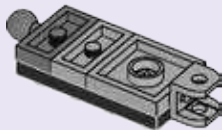

2x

19

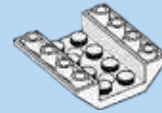
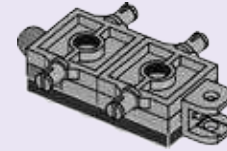

1x

20

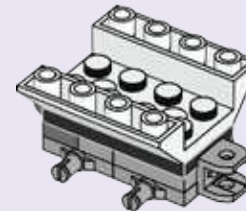
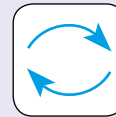

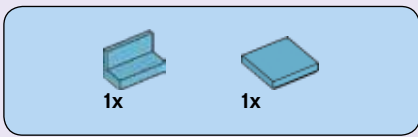

21

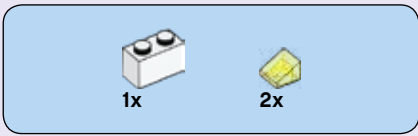
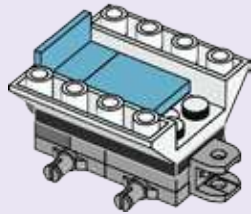

22

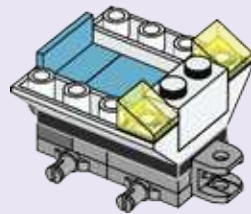

23

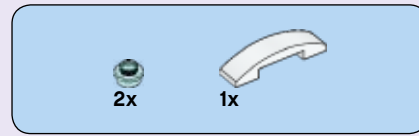
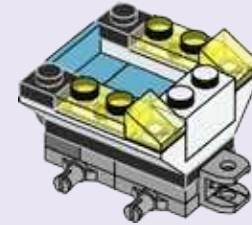

24

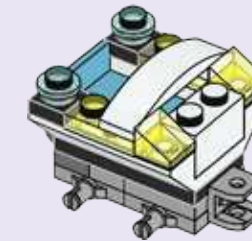



2x

25

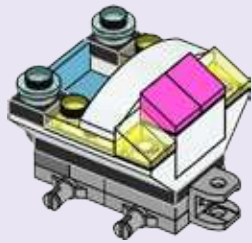

4x

26

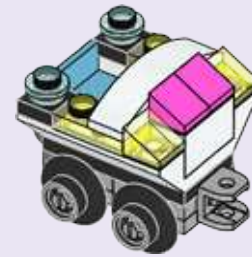

3x

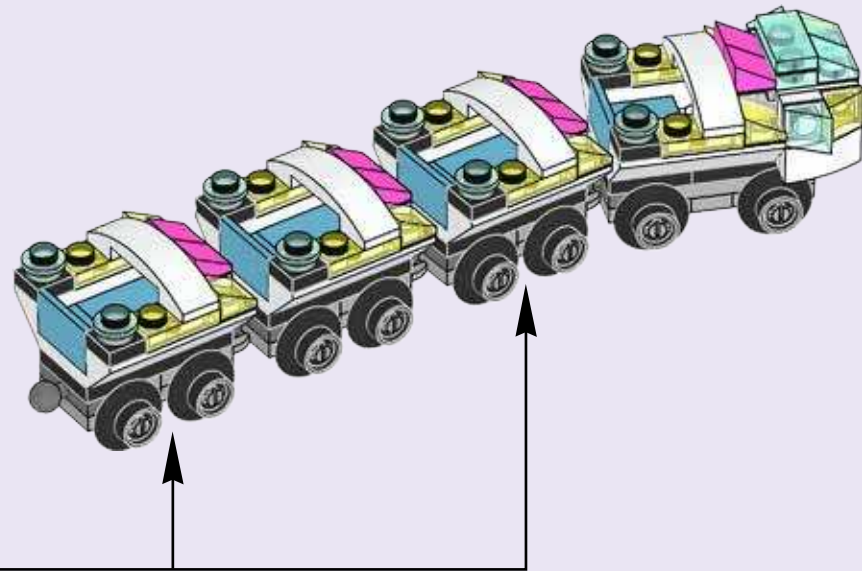

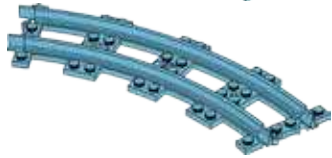
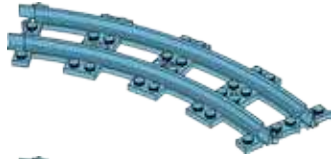
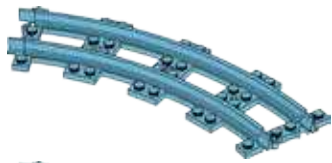

+

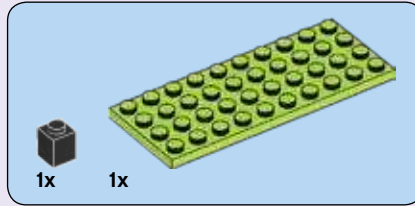
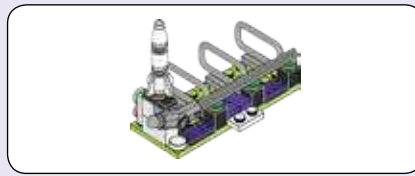
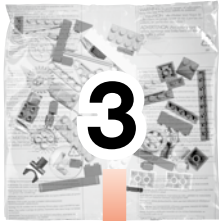

1

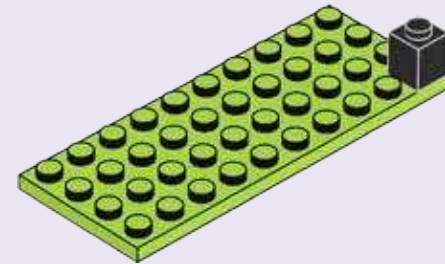



2

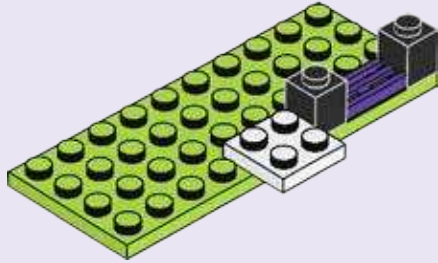

3

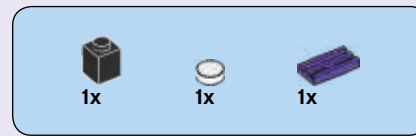
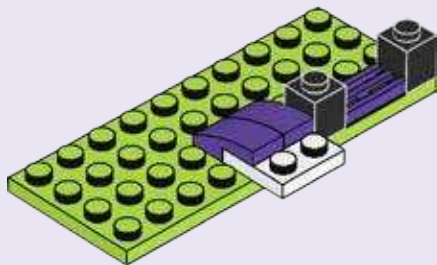

4

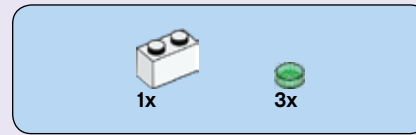
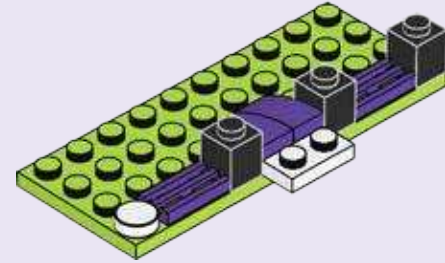

5

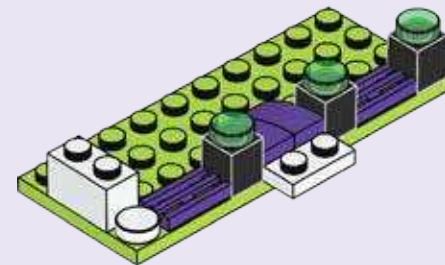

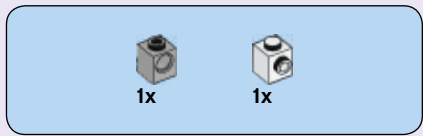

6

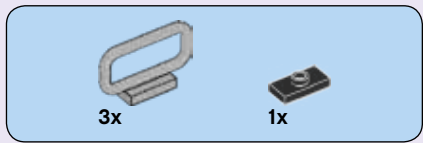
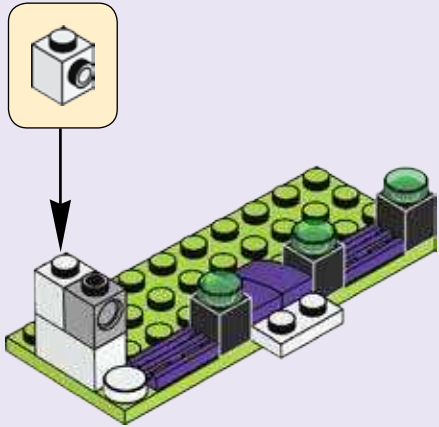

7

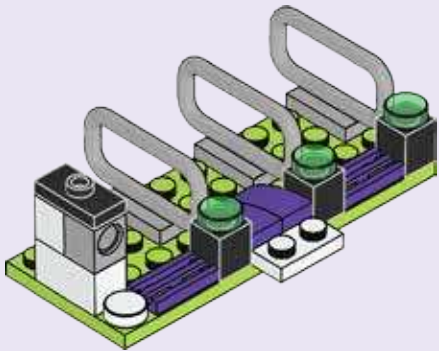

8

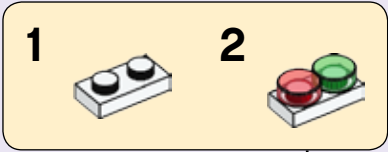
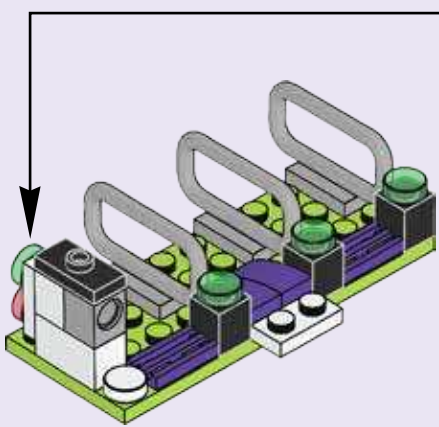

9

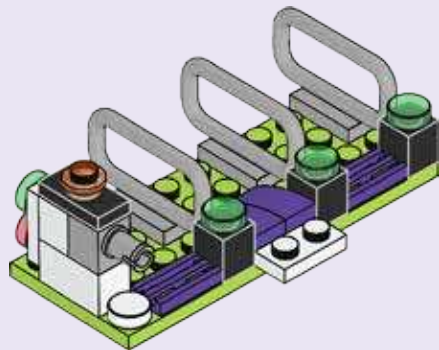
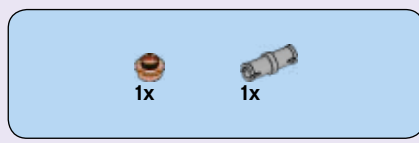

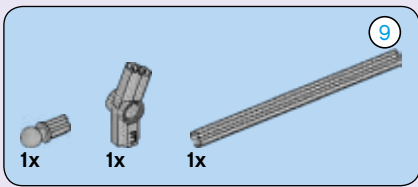

10

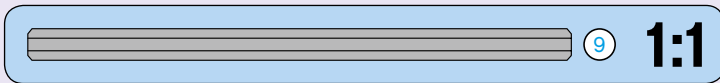
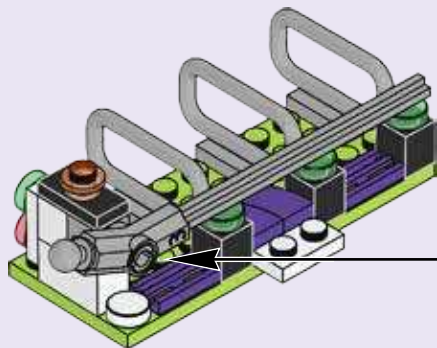
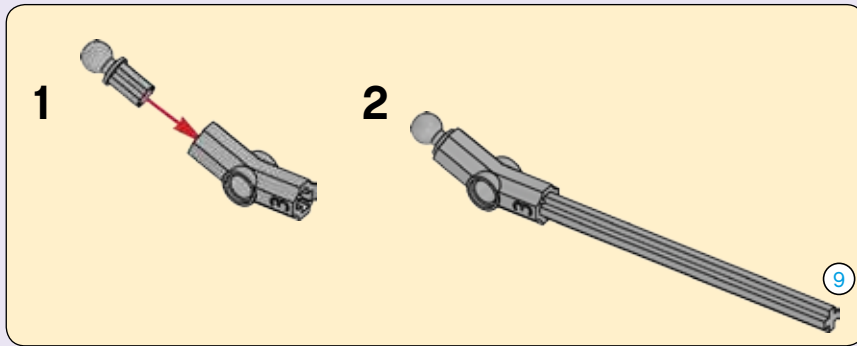

11

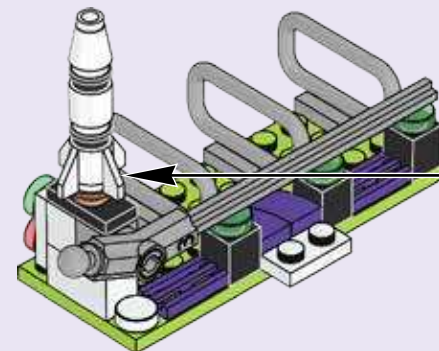
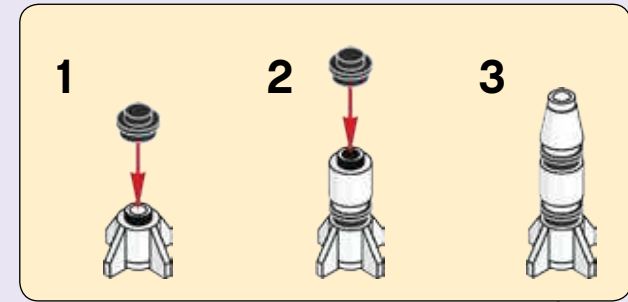

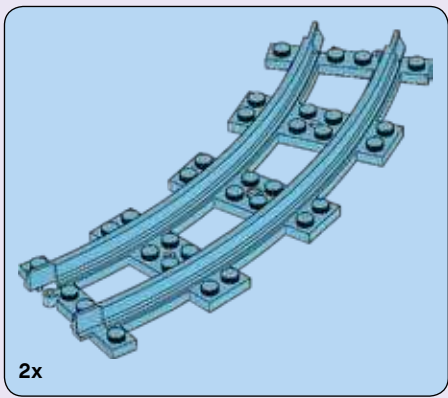

12

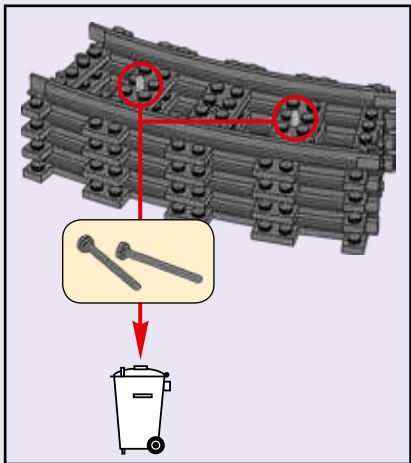
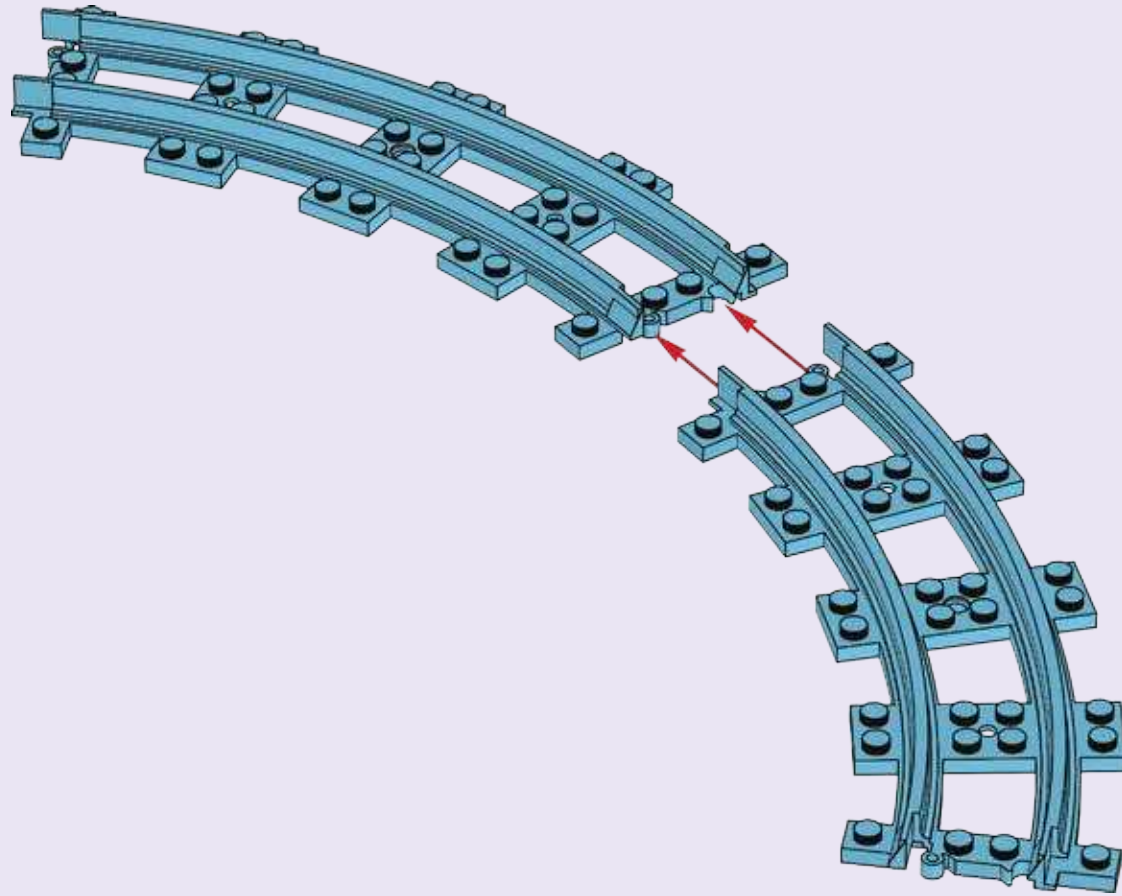

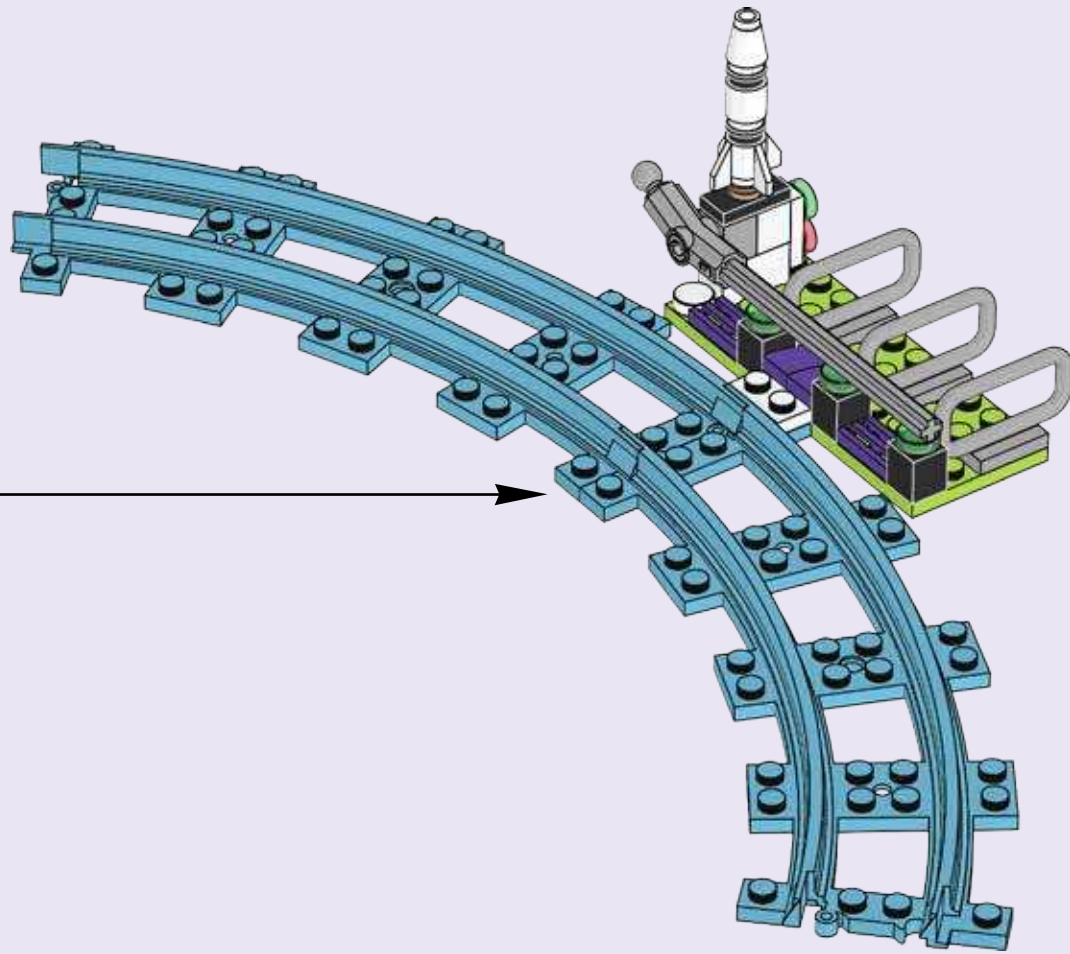

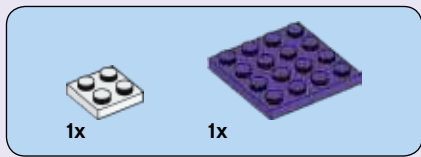

13

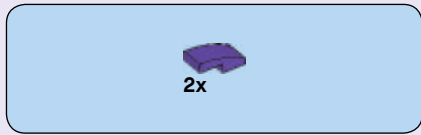

14

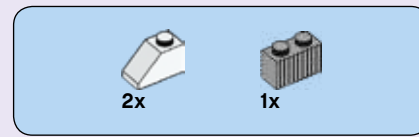

15

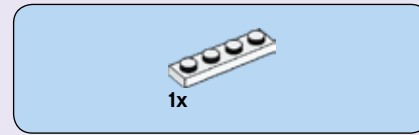

16



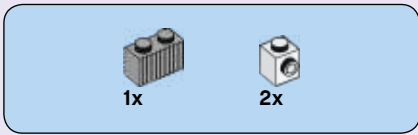

17

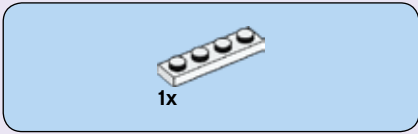
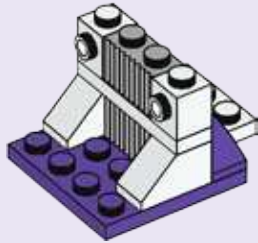

18



19

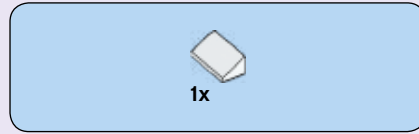

20

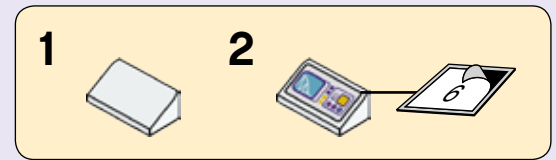

21

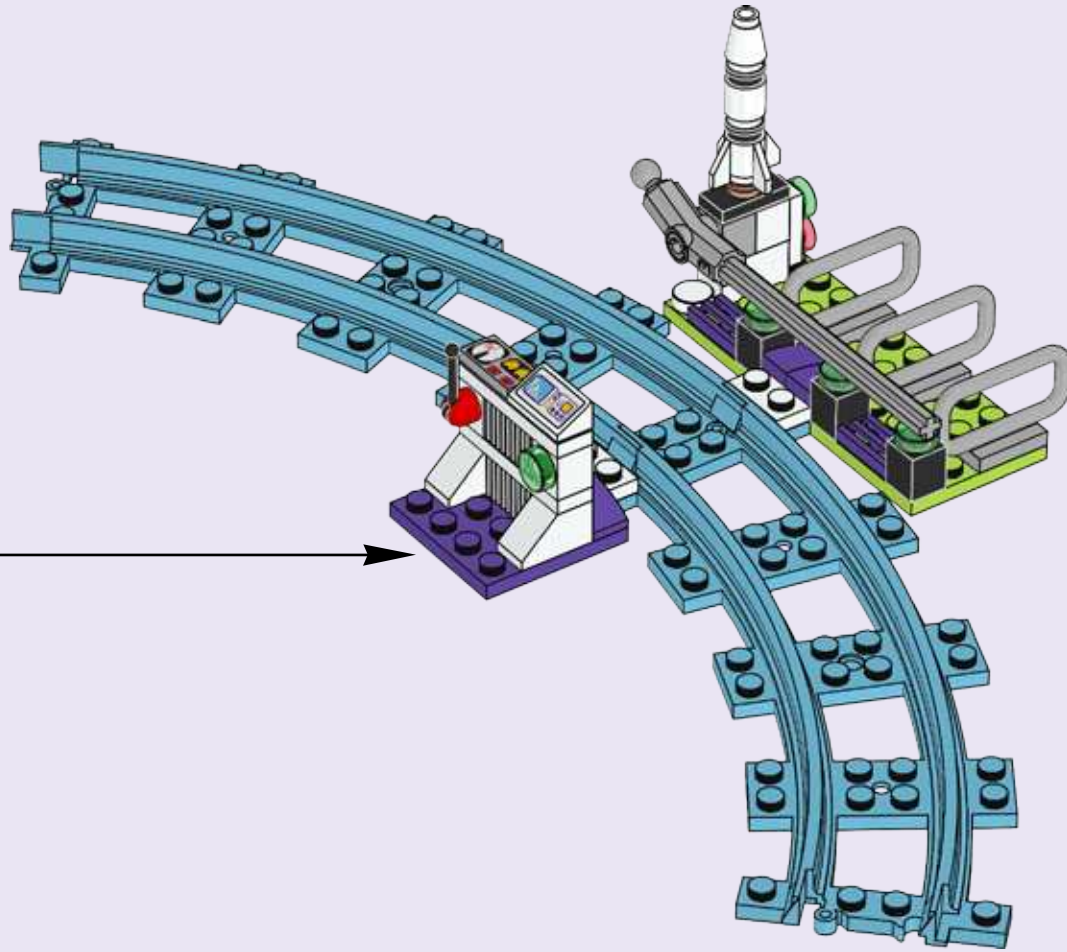

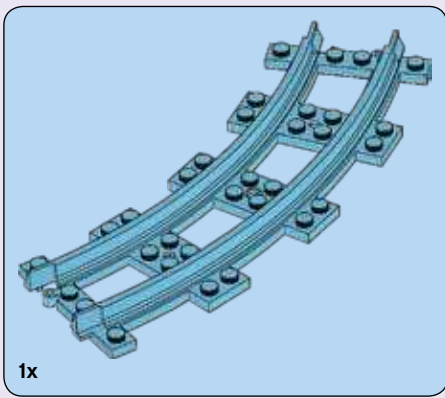

22

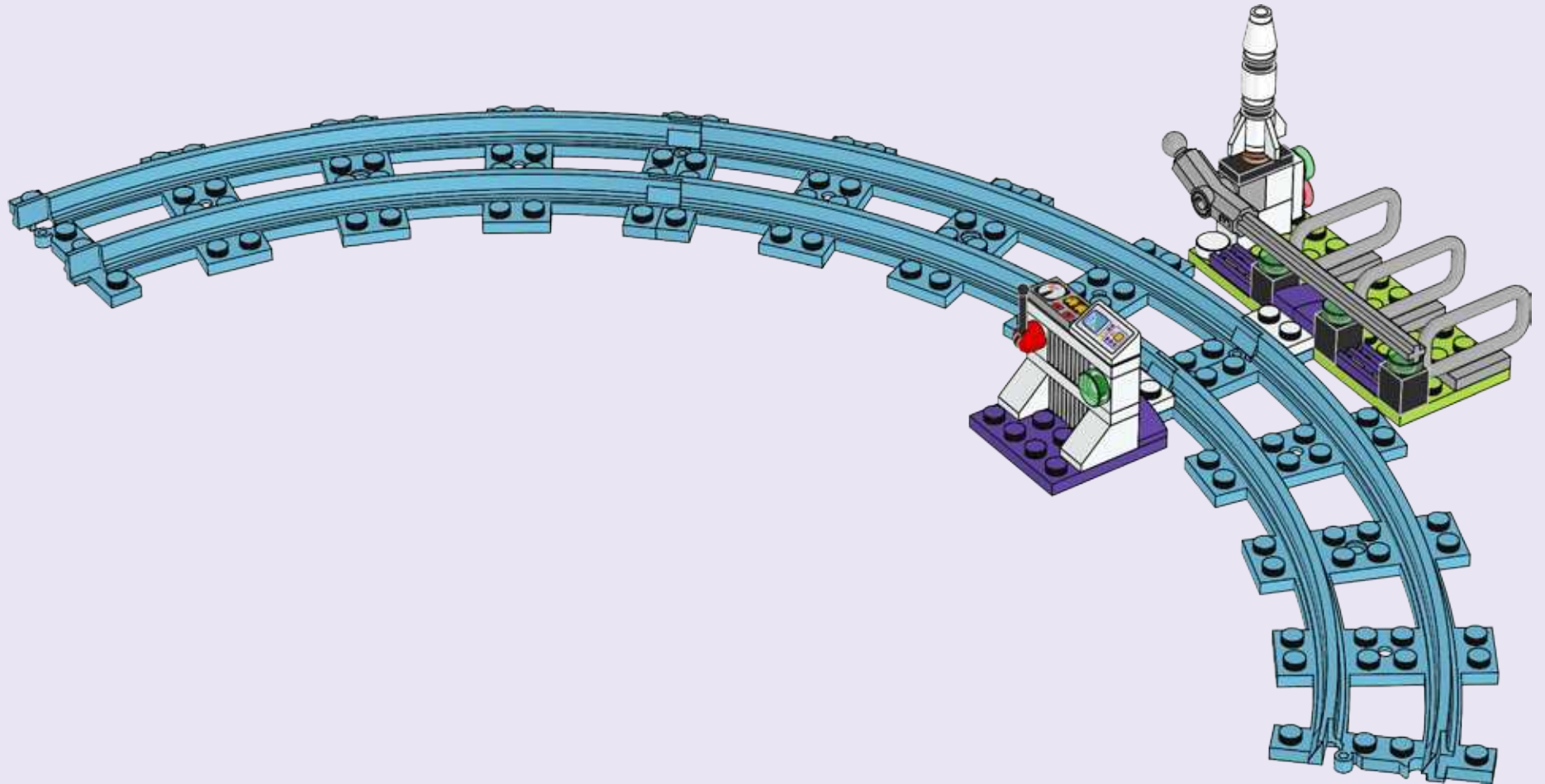

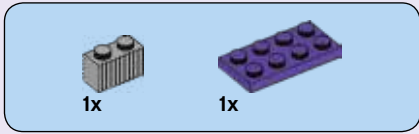
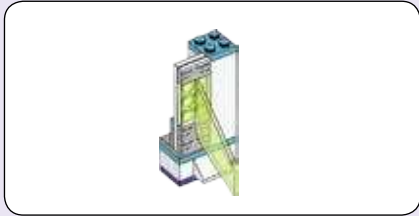
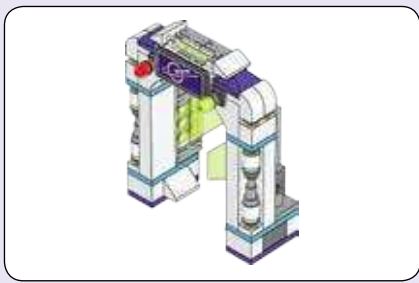

23

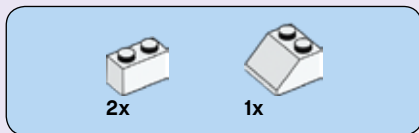

24

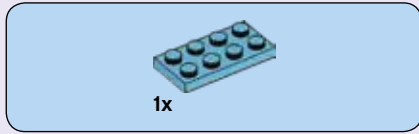

25



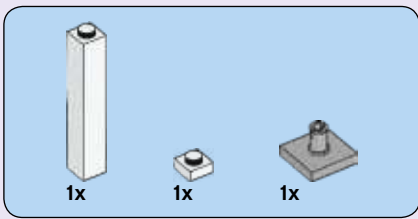

26

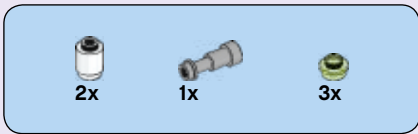
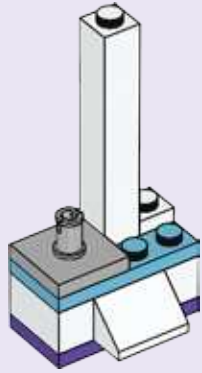

27

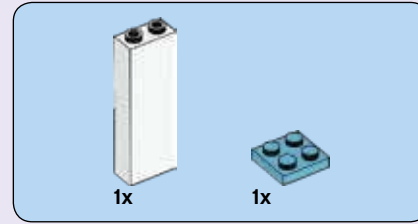
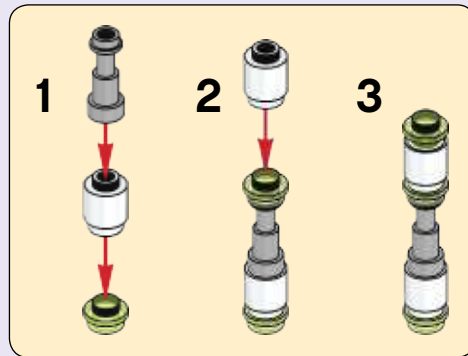
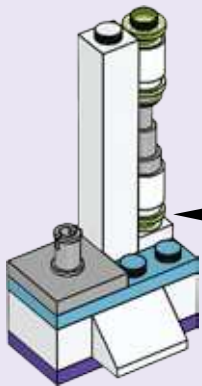

28



29

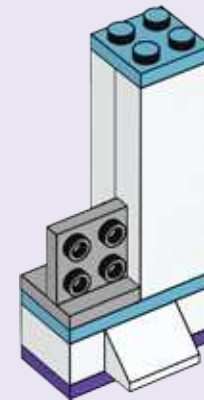

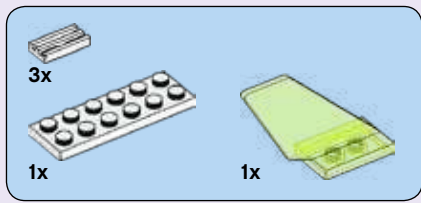

30

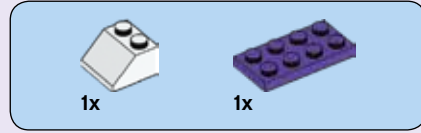
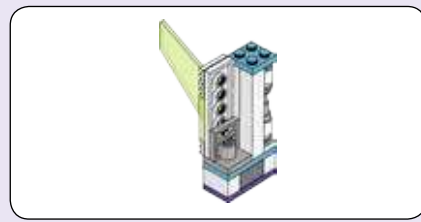
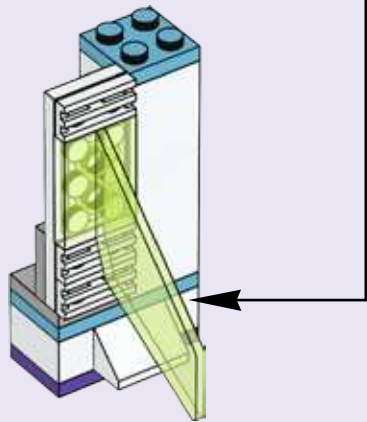
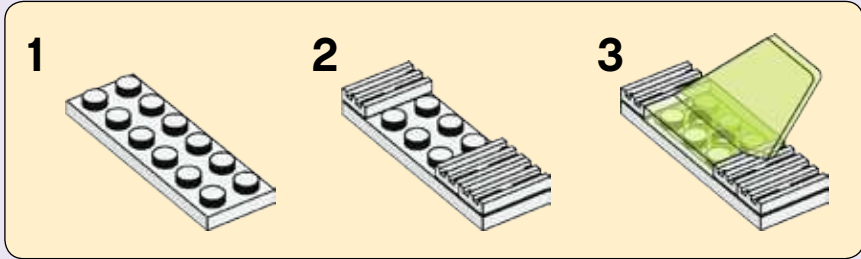

31

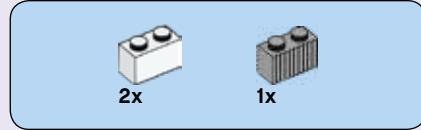

32



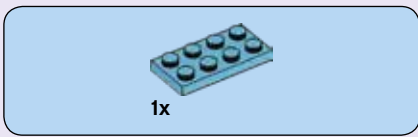

33

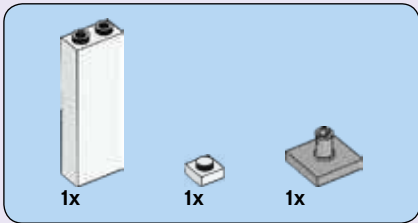

34

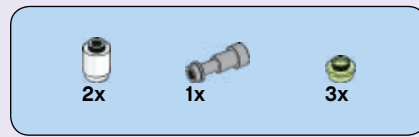
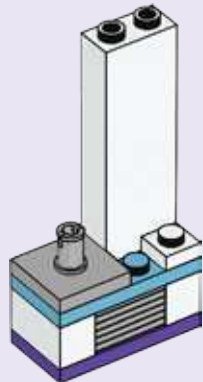

35

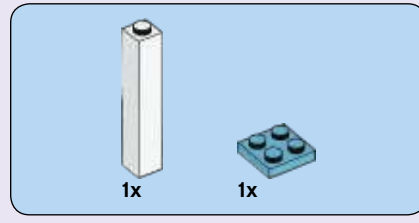
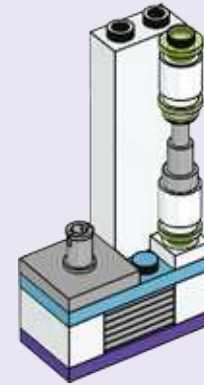
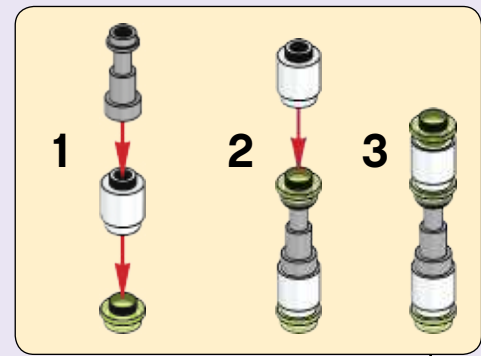

36



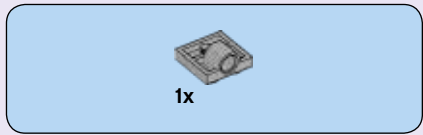

37

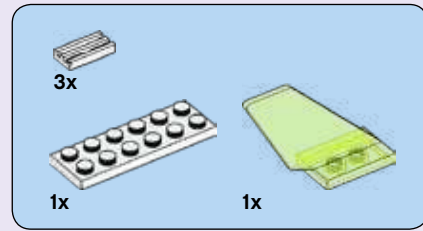
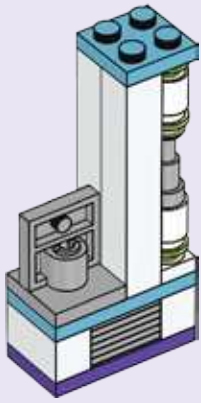

38

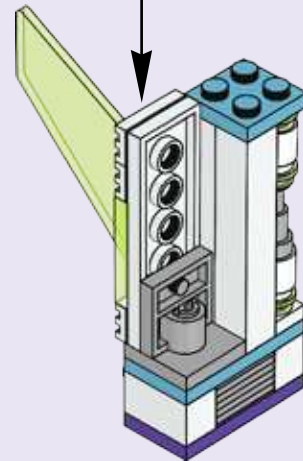
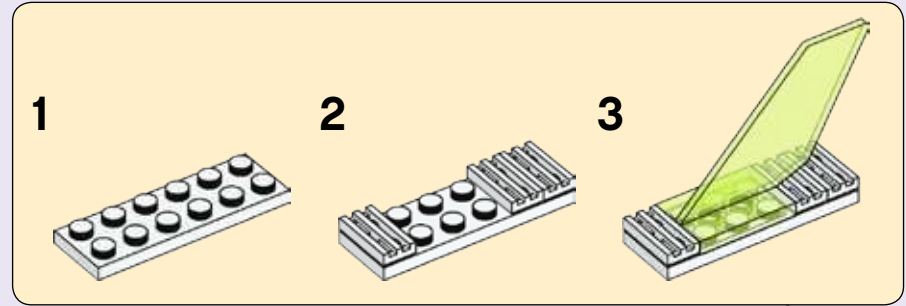

39

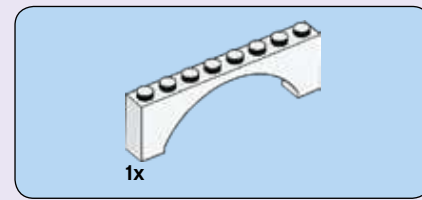
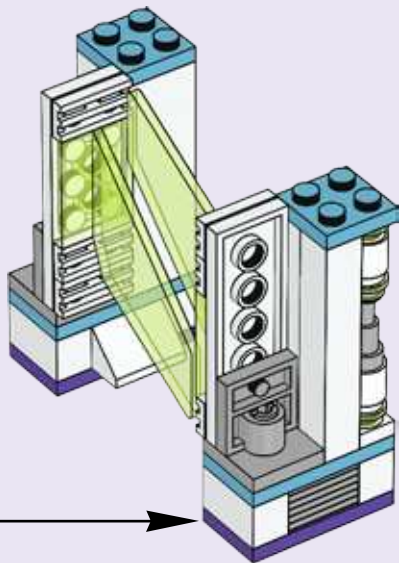

40

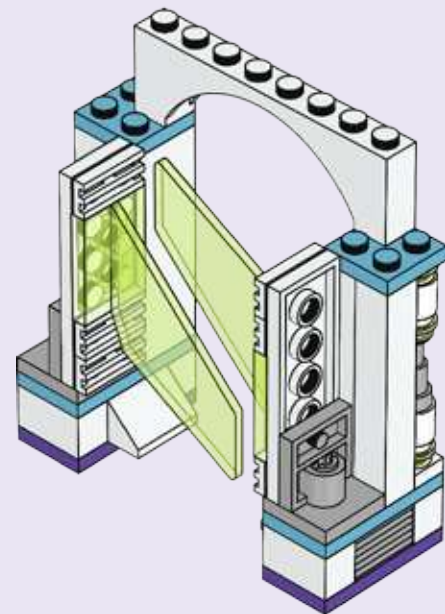



2x

41

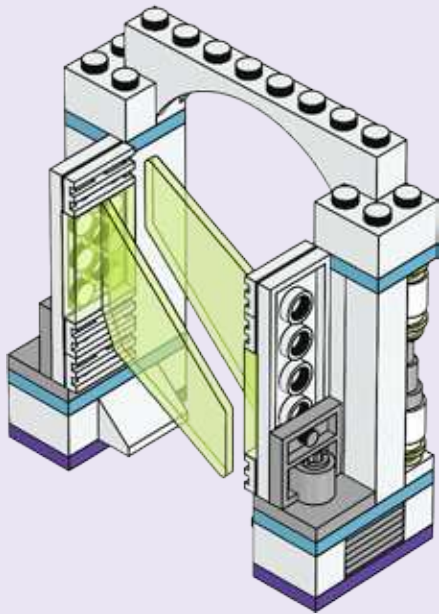

4x

42

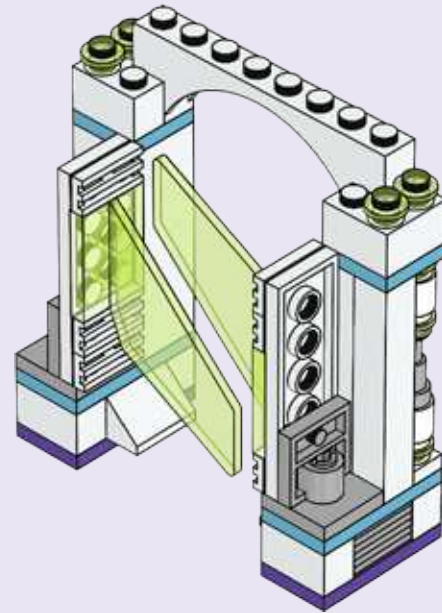



2x

43

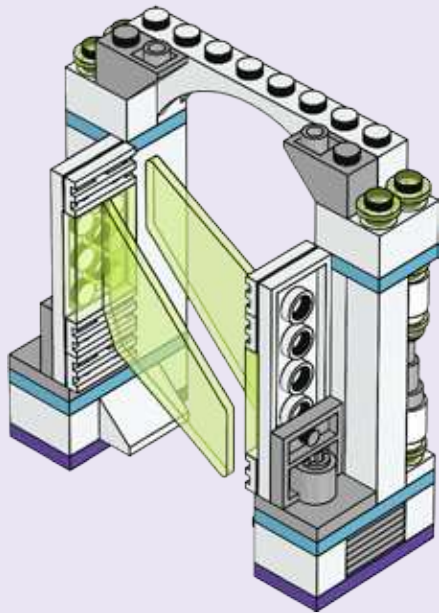

4x

44

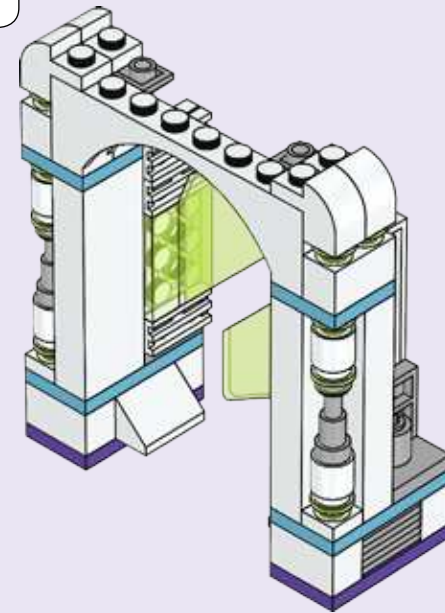
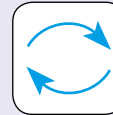

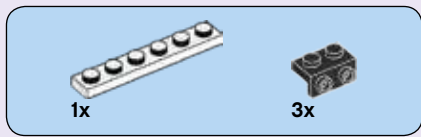

45

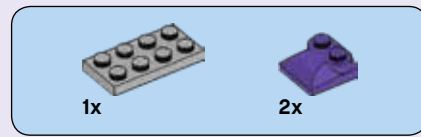
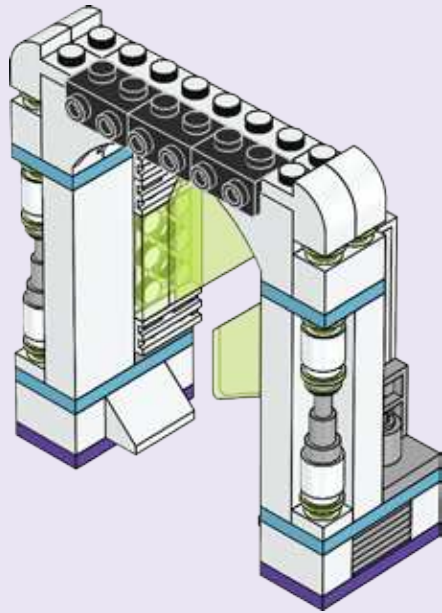

46

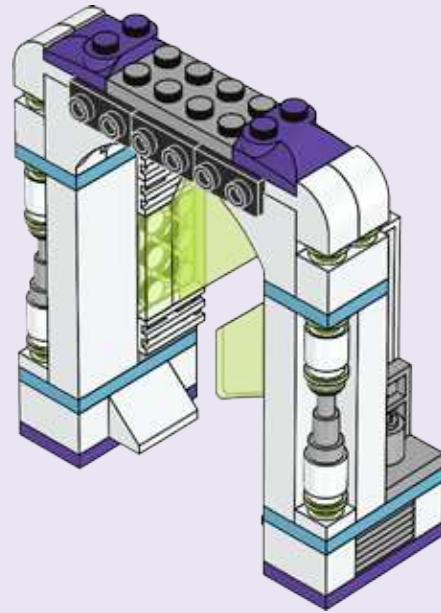

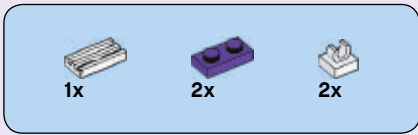

47

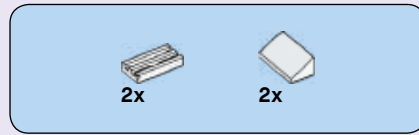
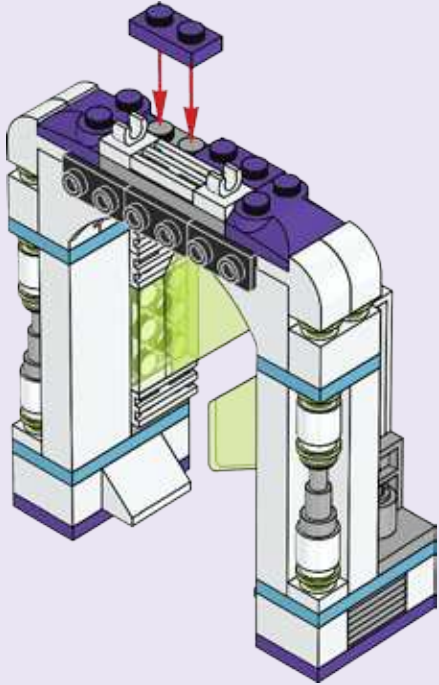

48

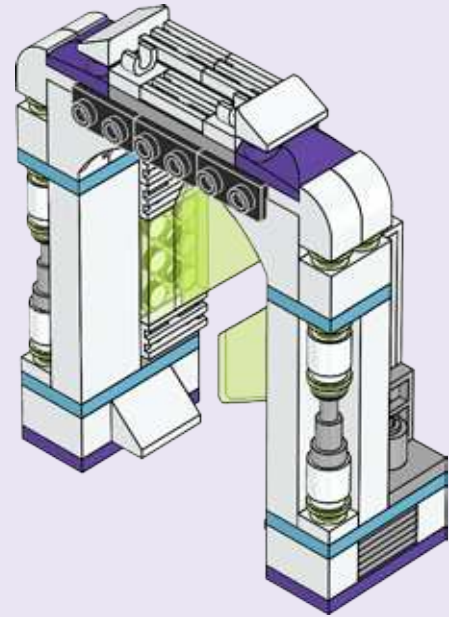

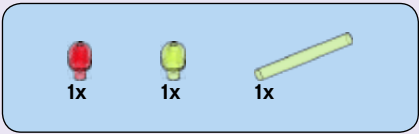

49

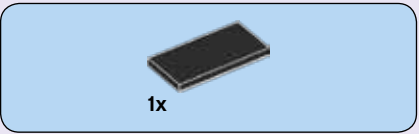
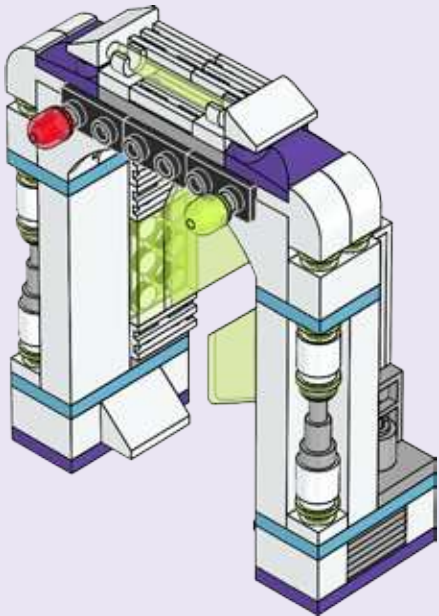

50

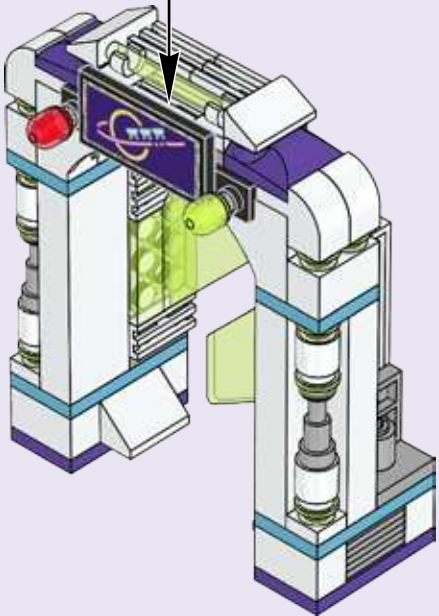
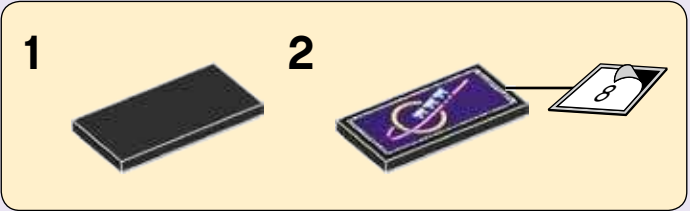

51

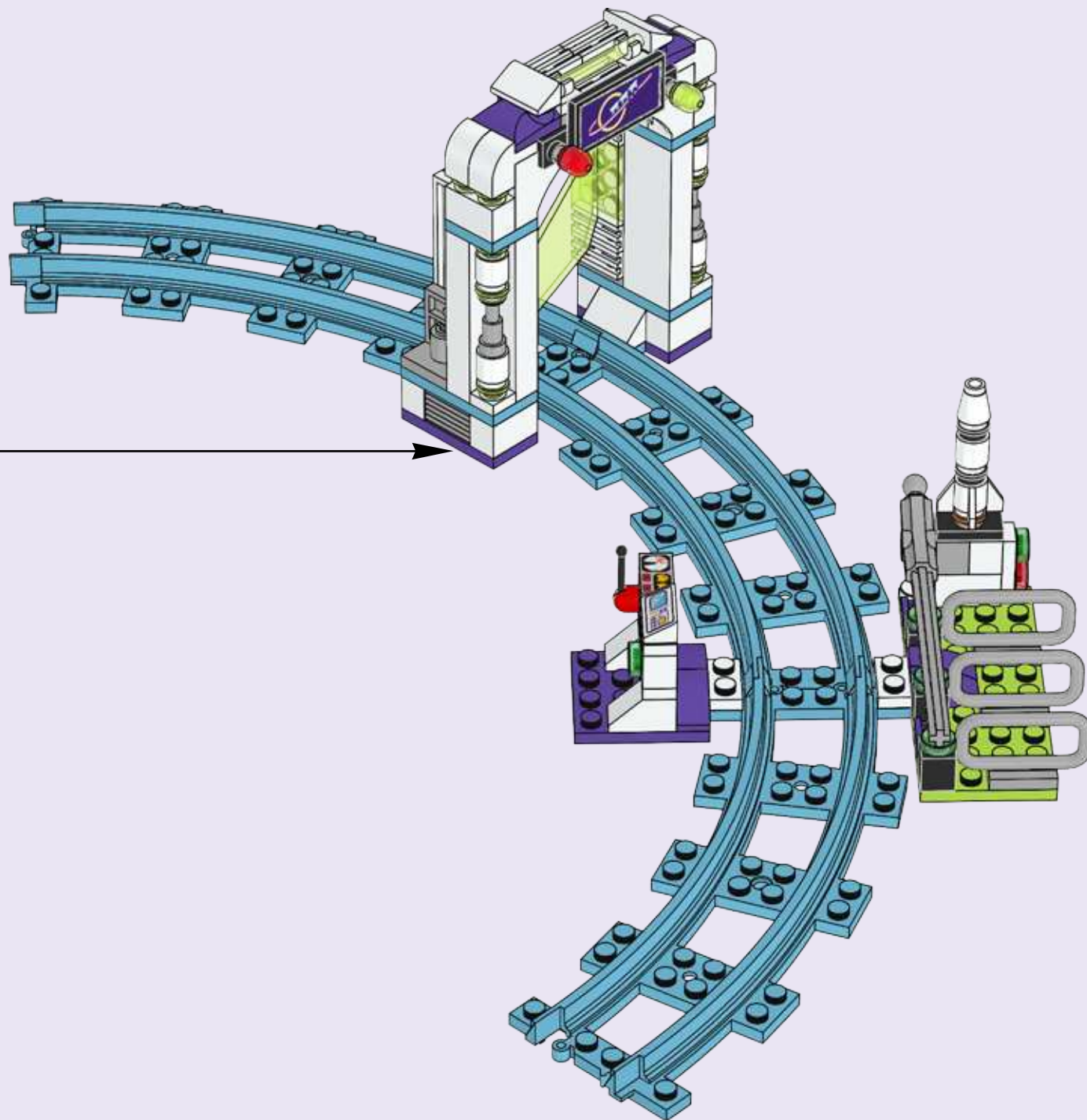

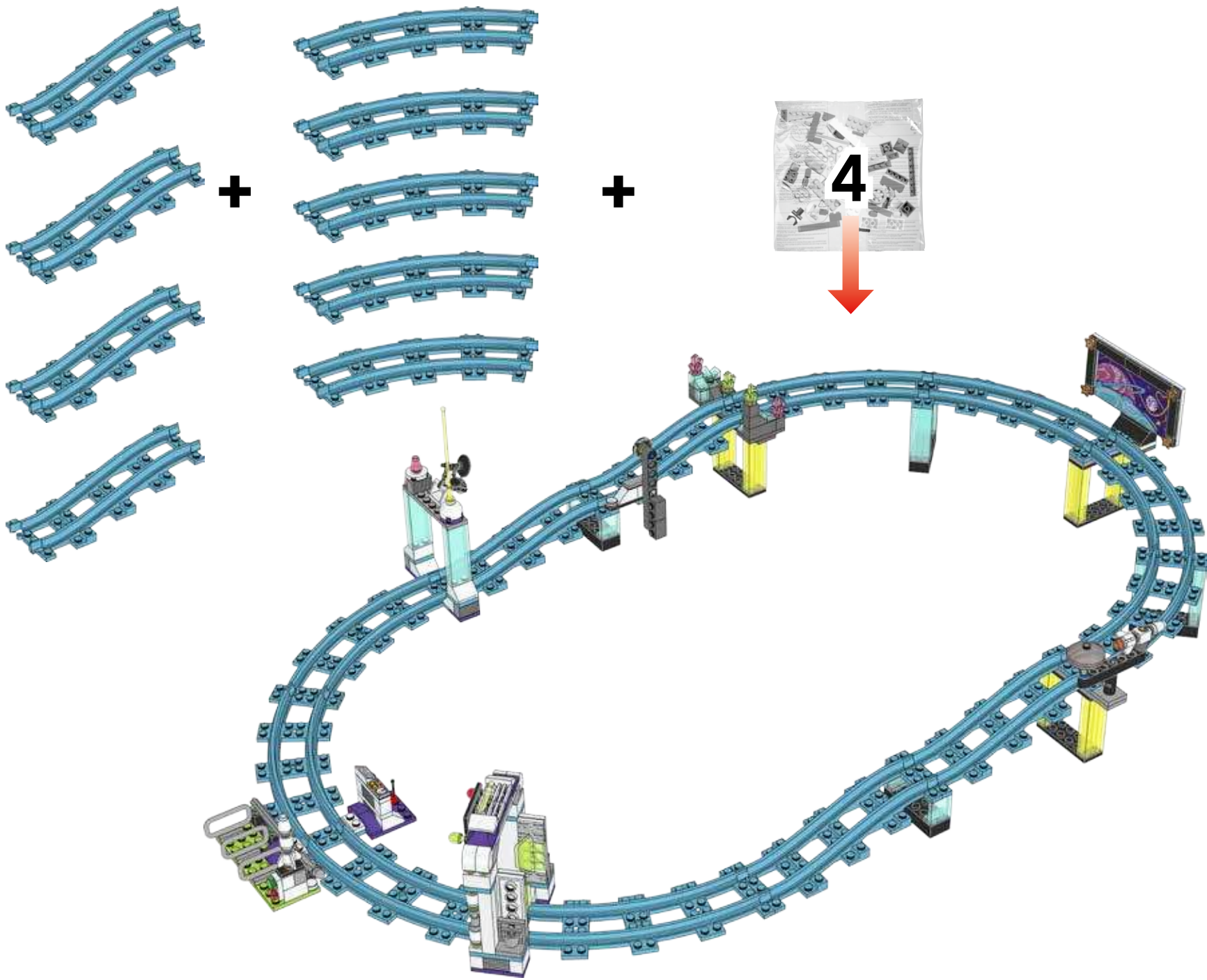

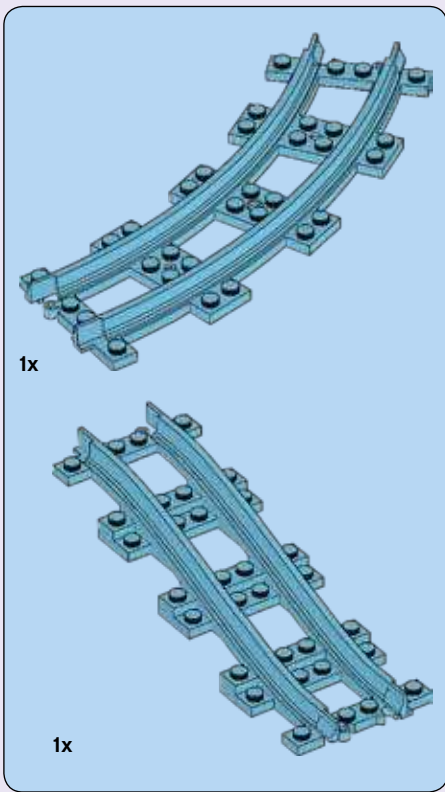

52

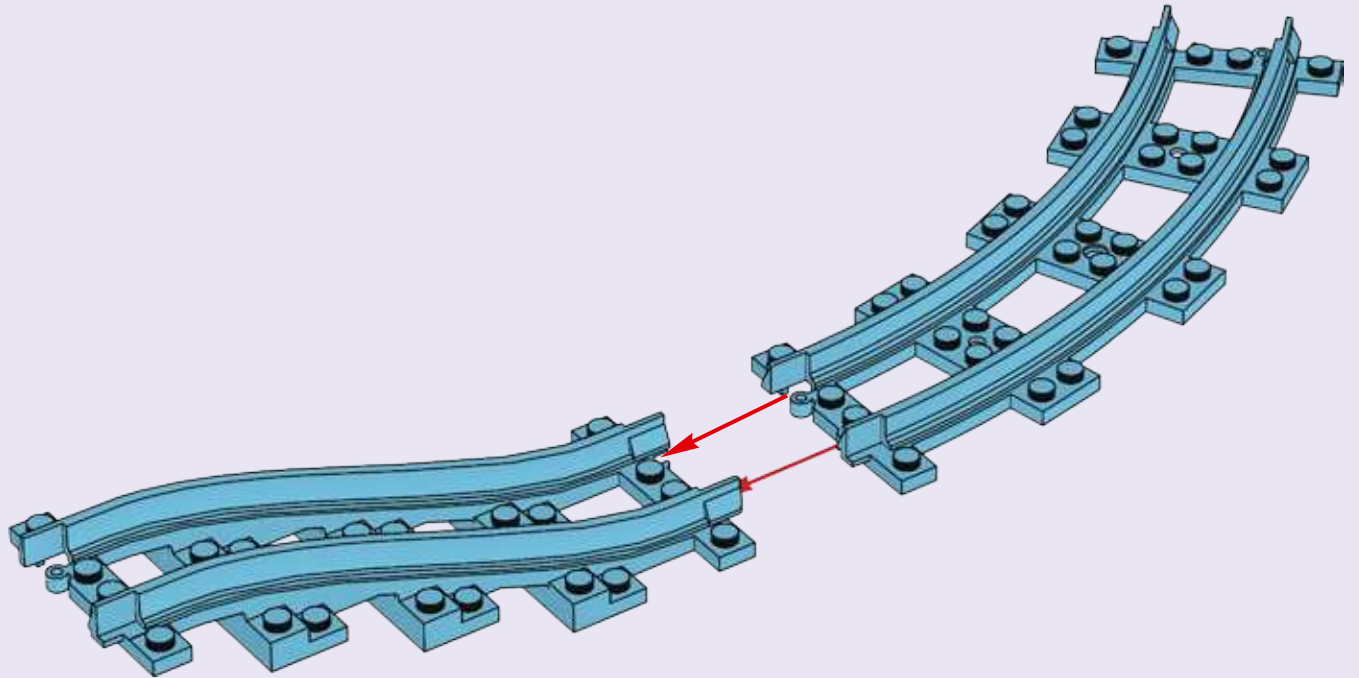

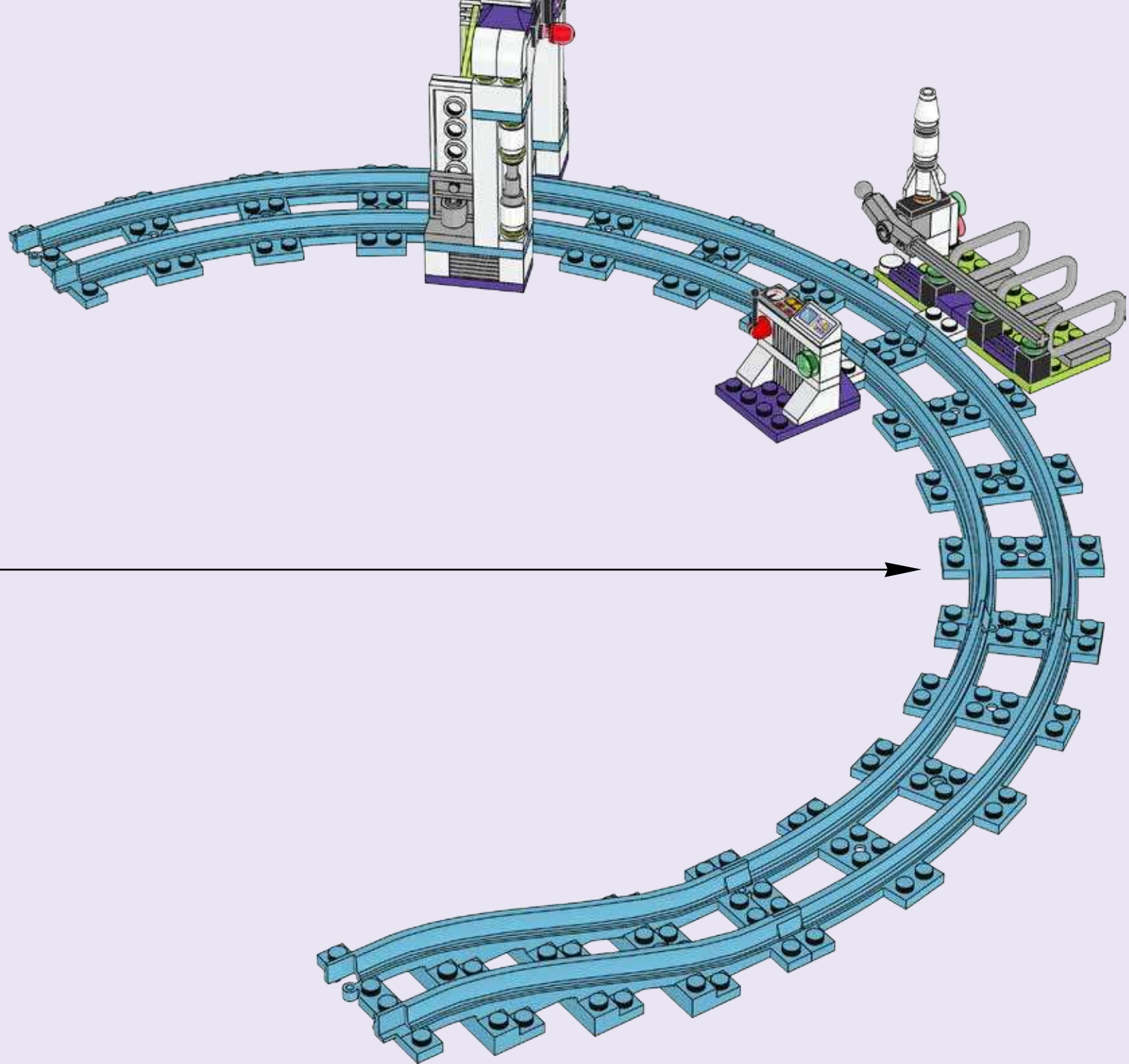

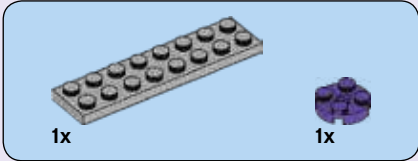

53

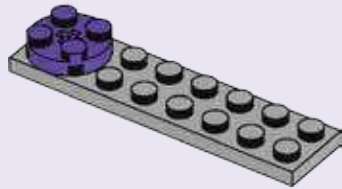

54

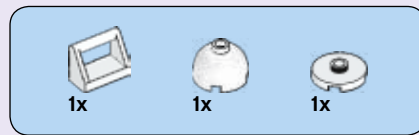
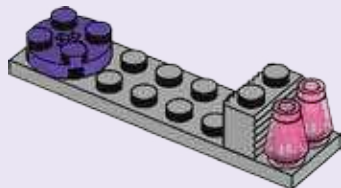

55

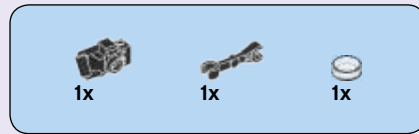
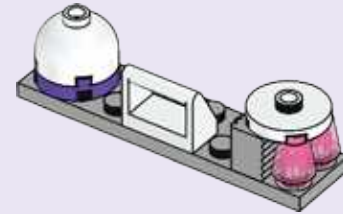

56

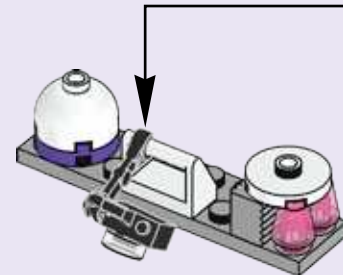
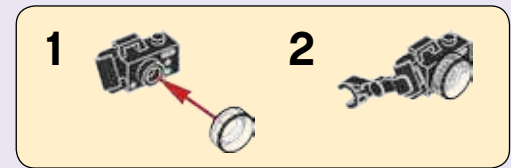

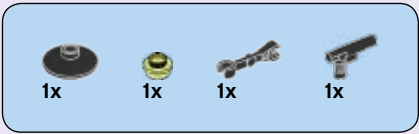

57

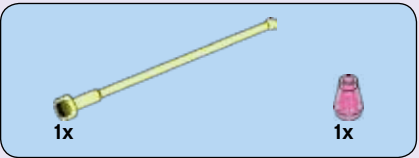
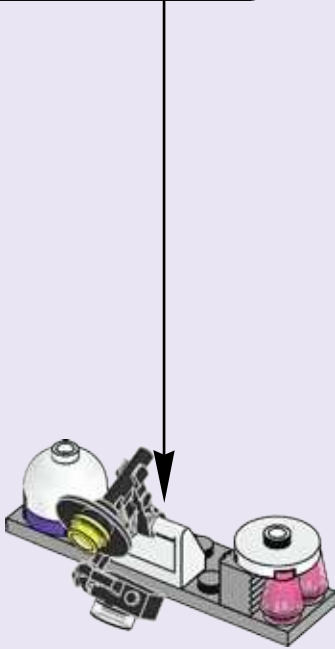
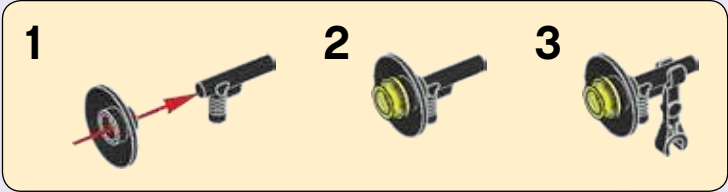

58



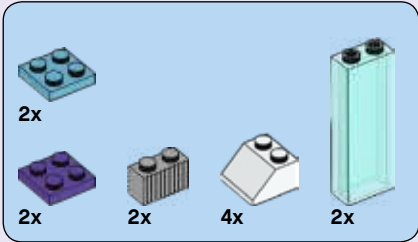

59

1



2



3



4



5

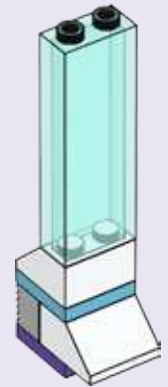

2x

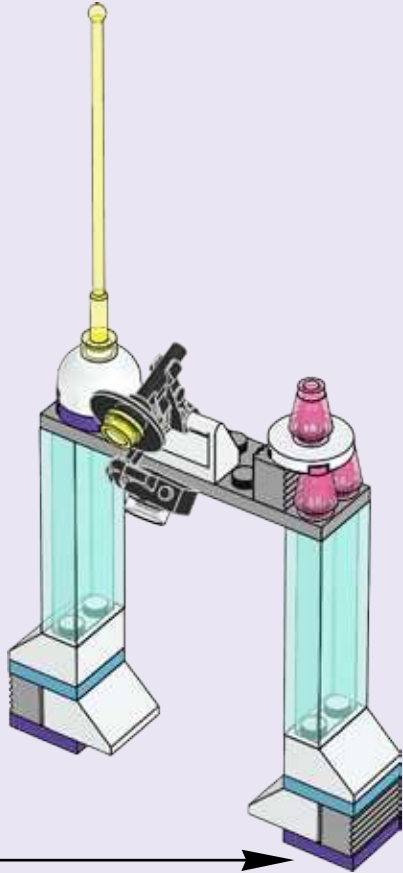

60

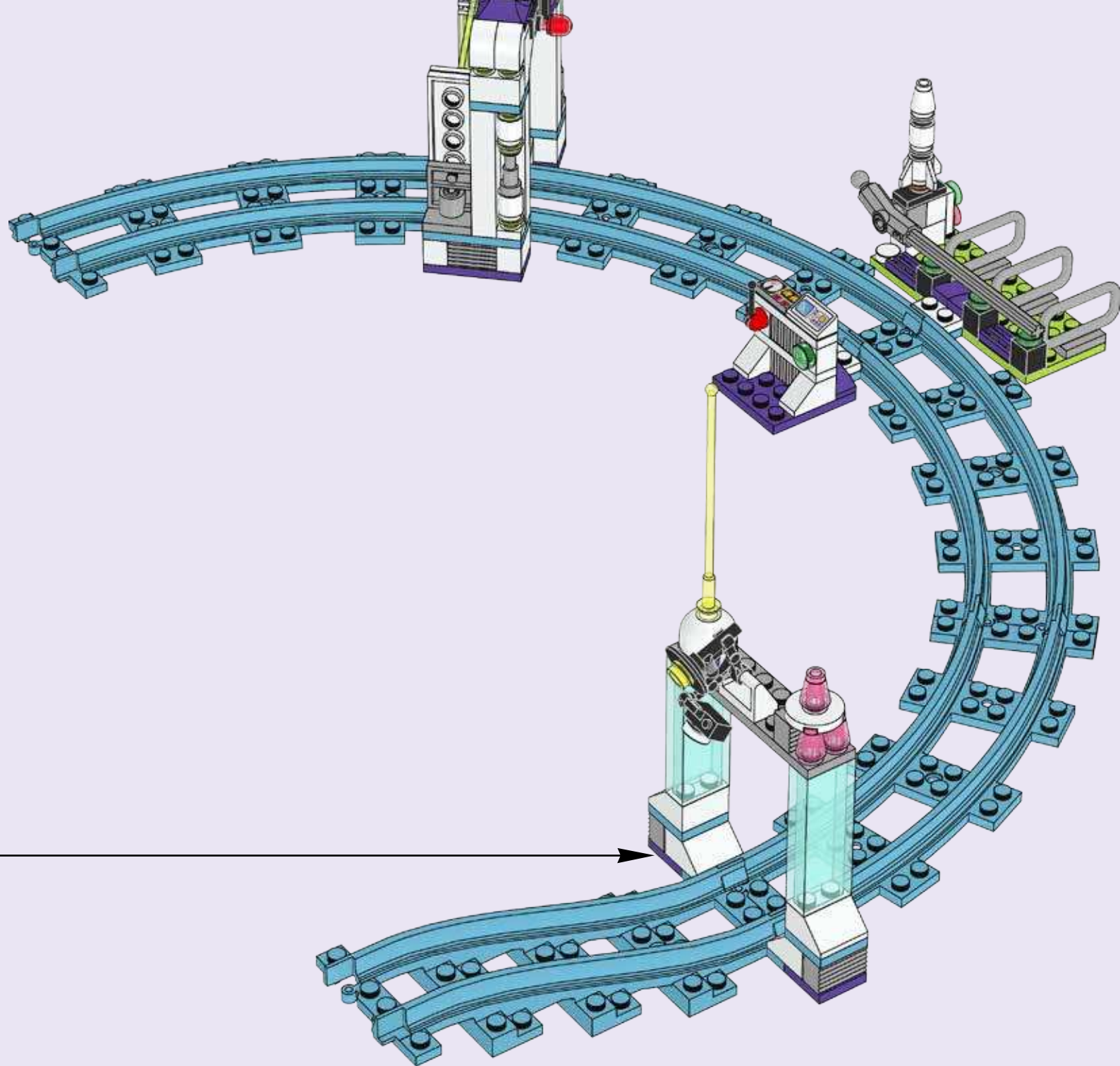

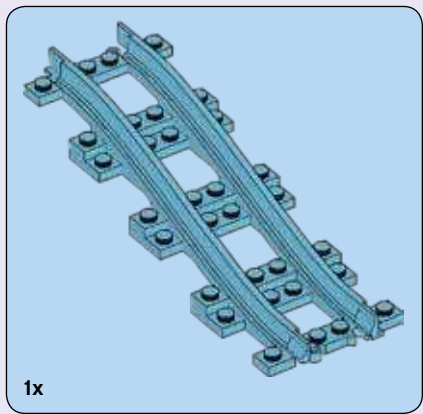

61

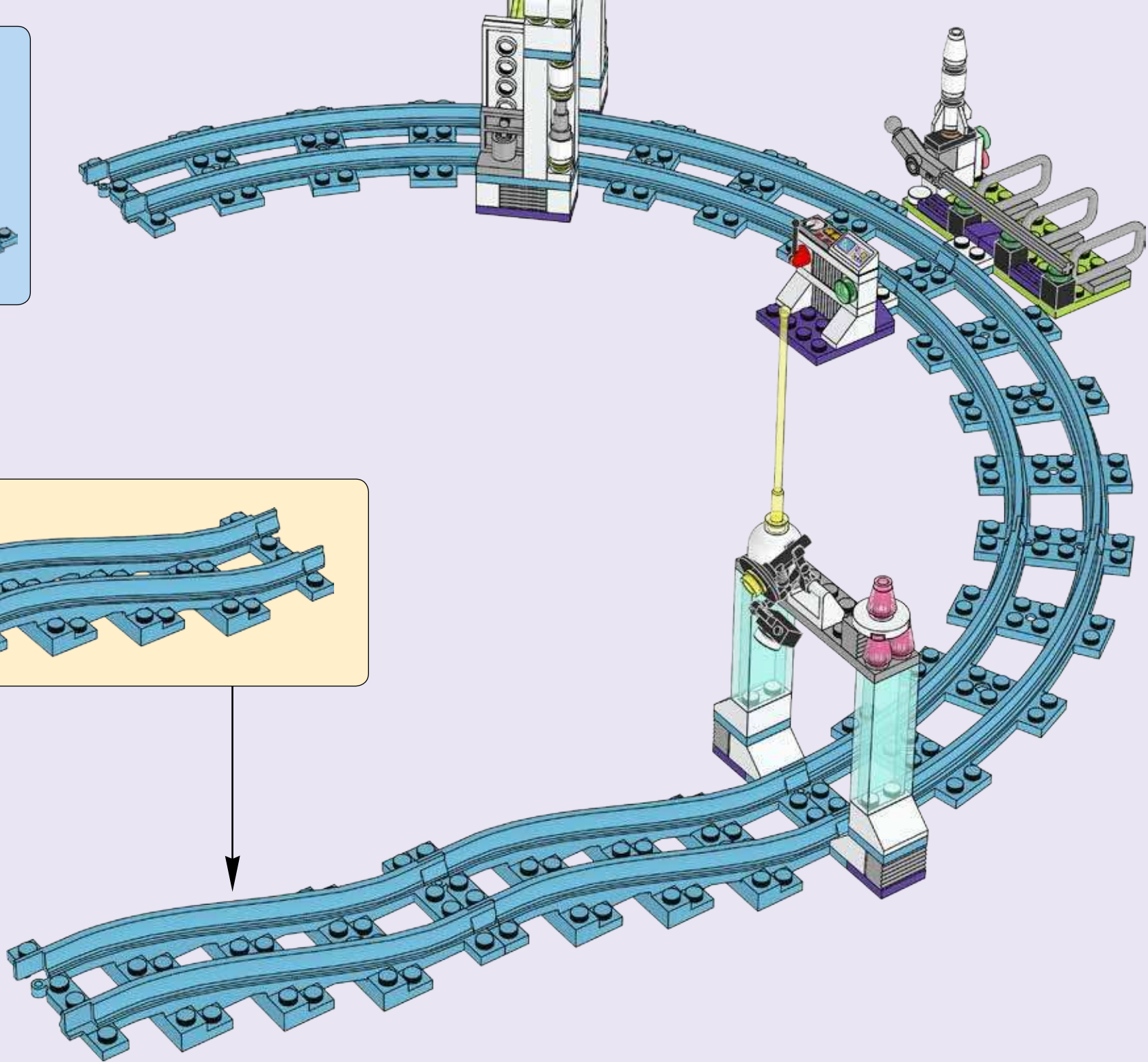
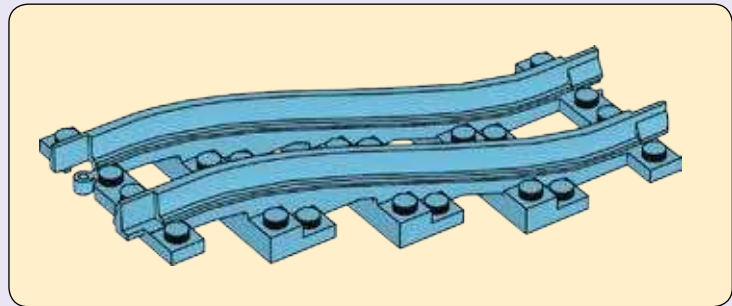

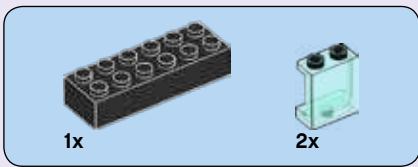

62

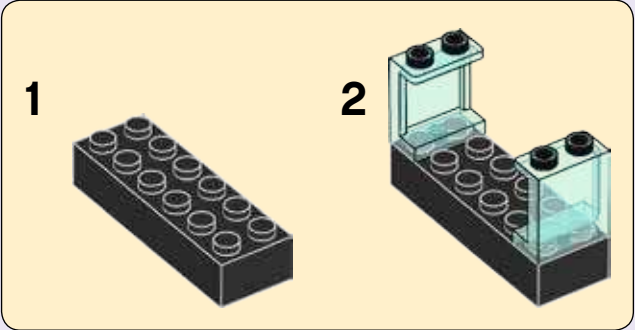
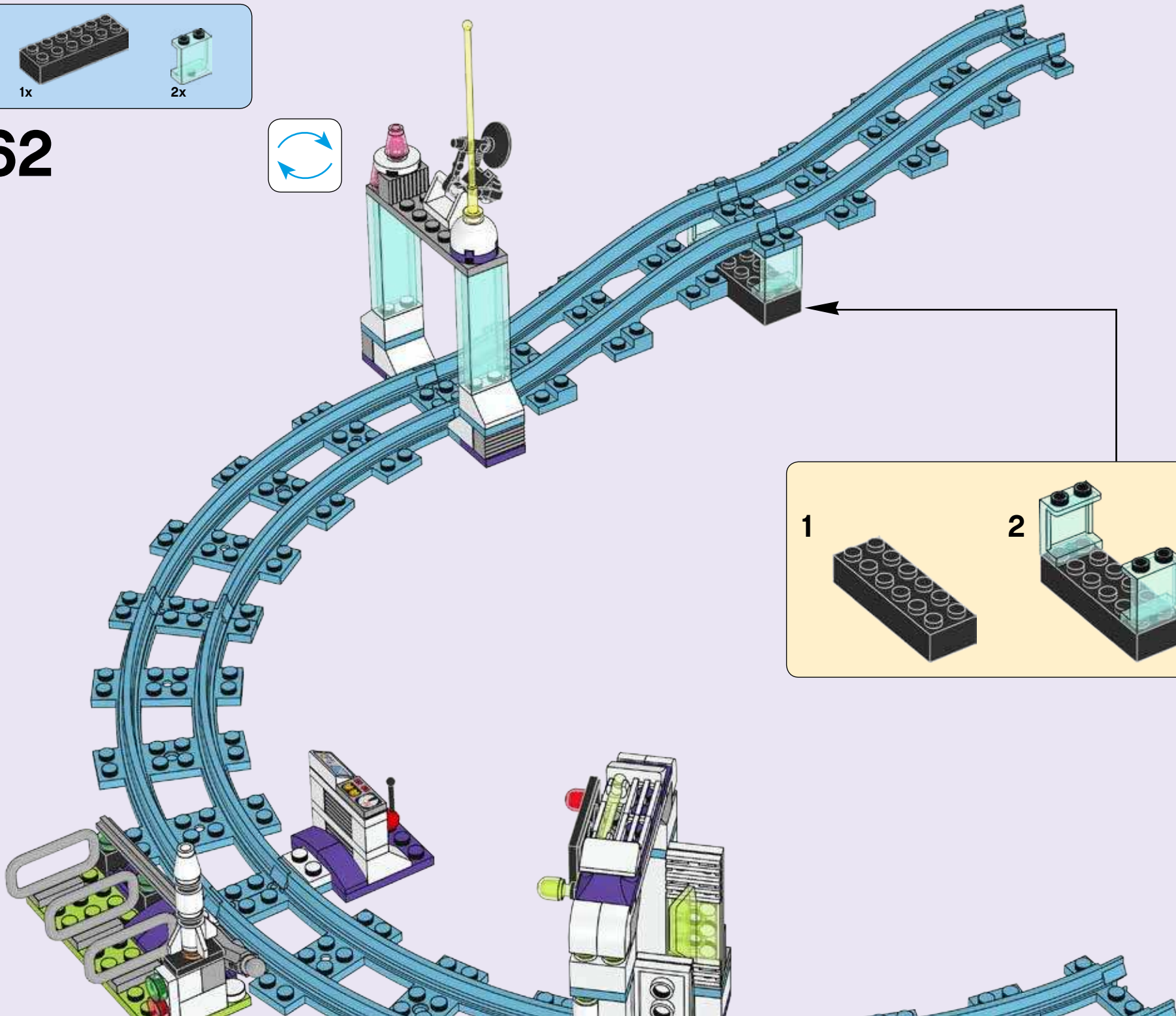
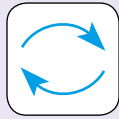

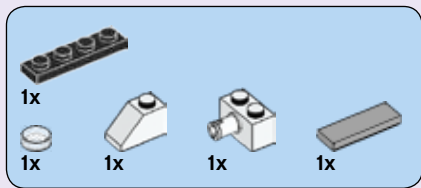

63

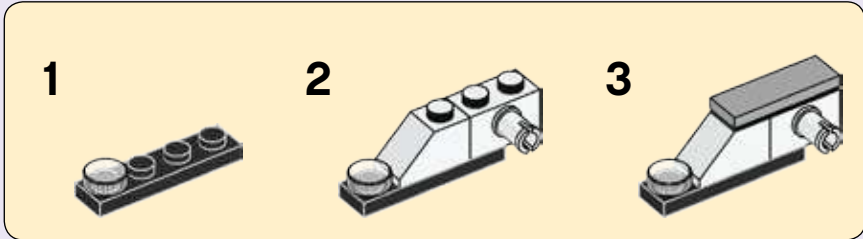
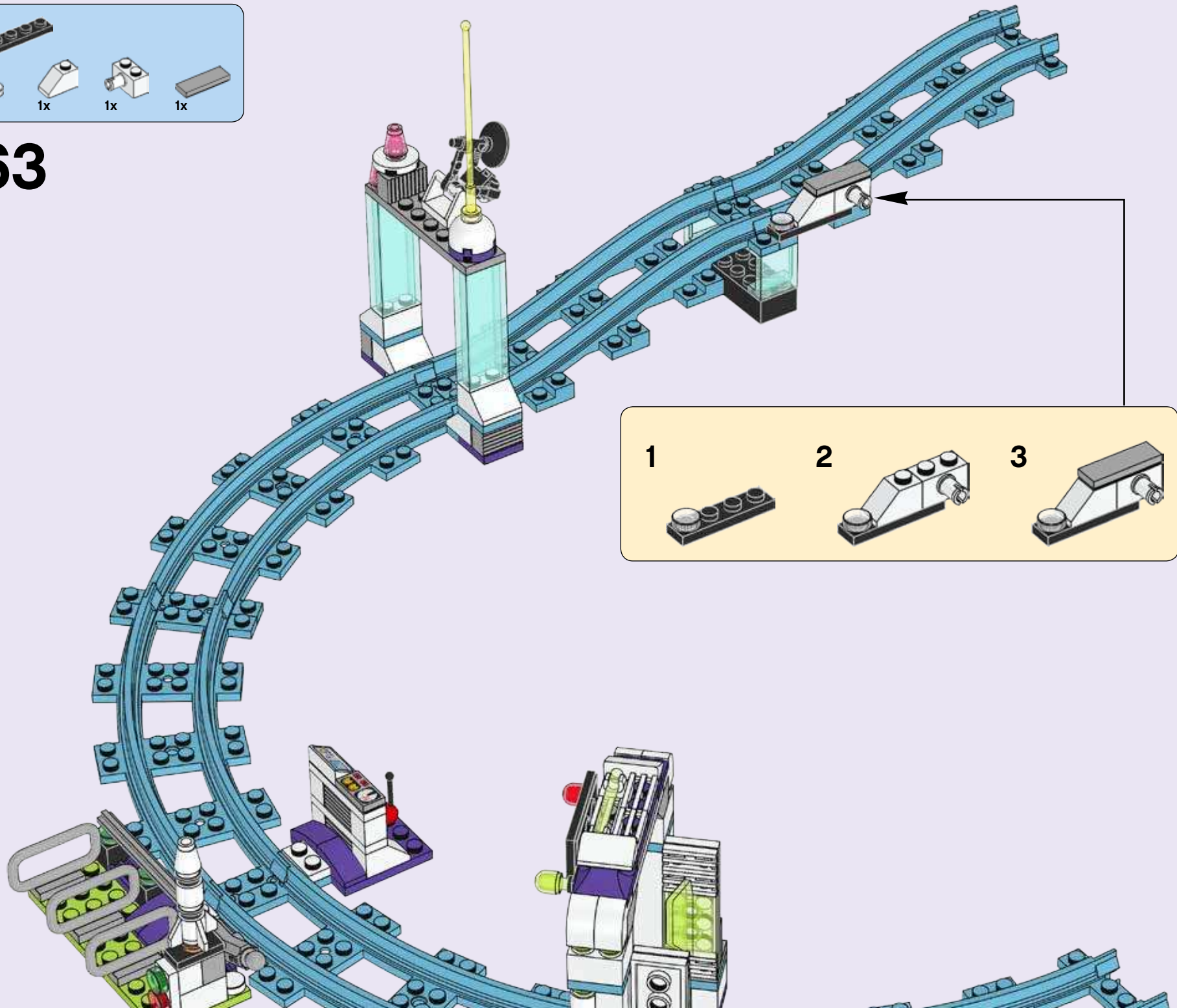

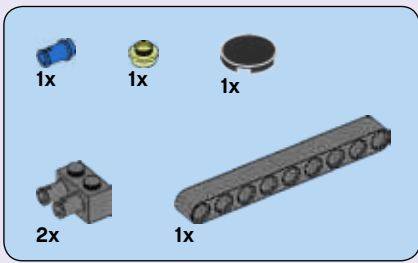

64

1

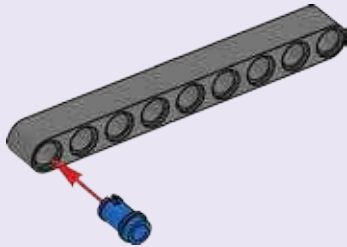

2

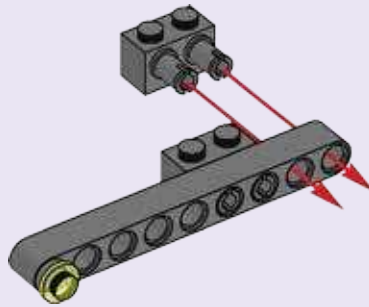

3

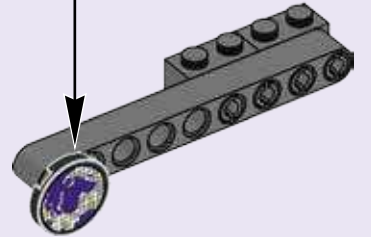

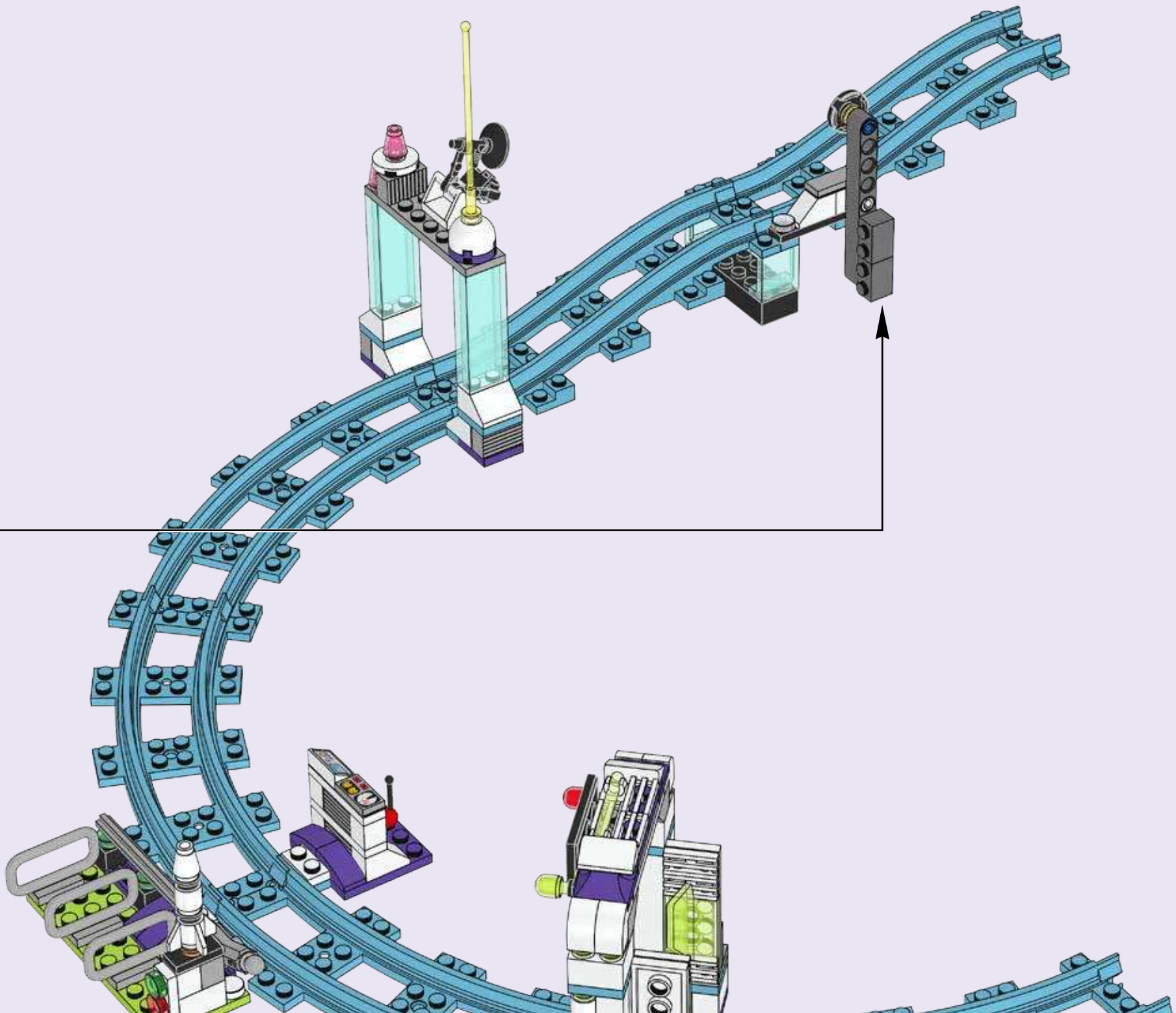

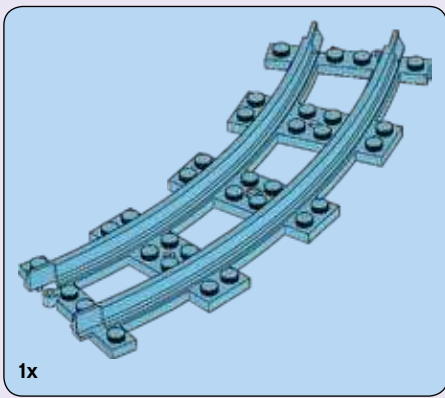

65

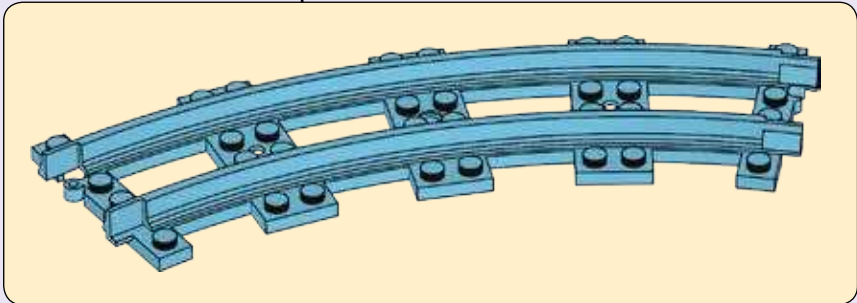
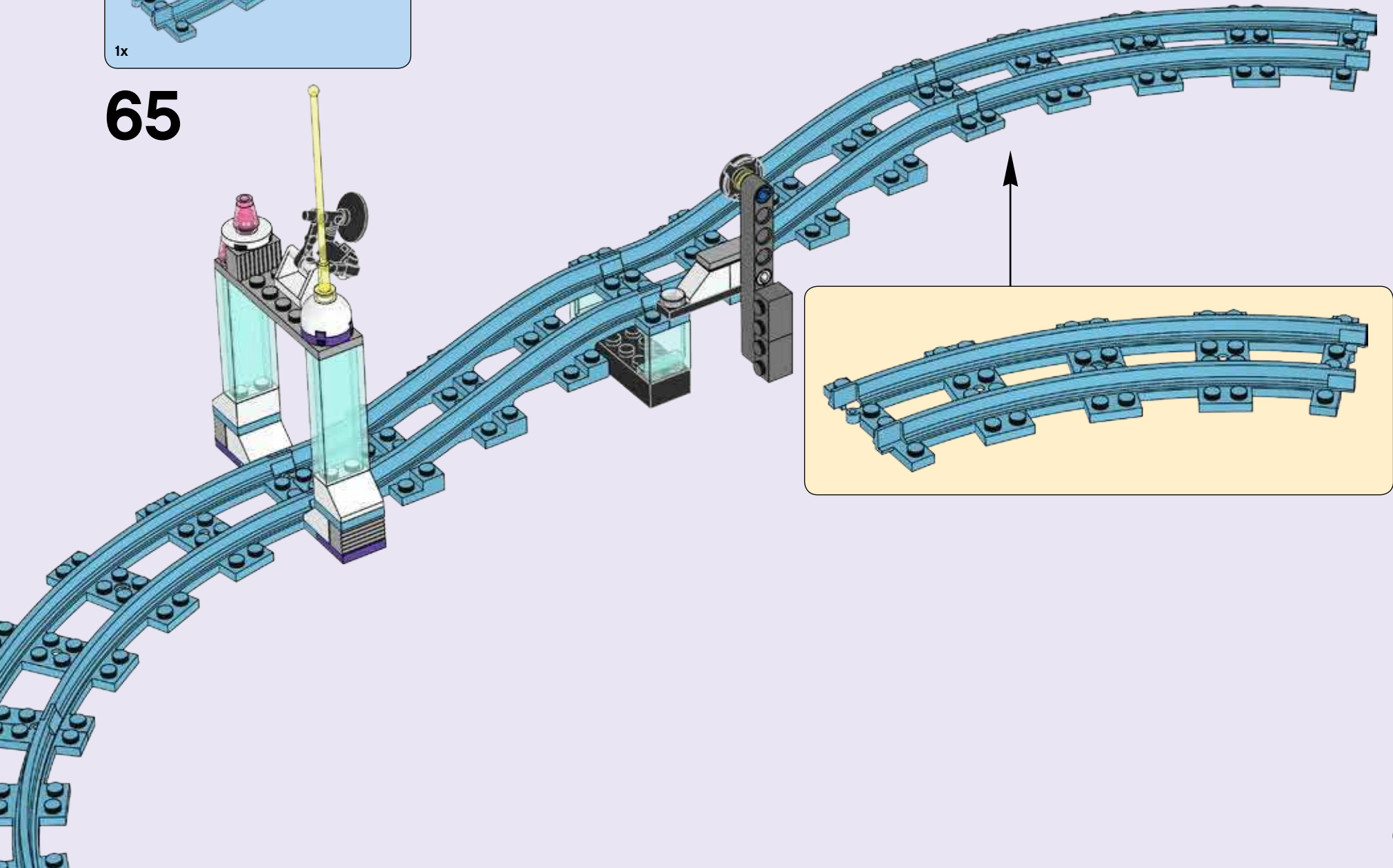

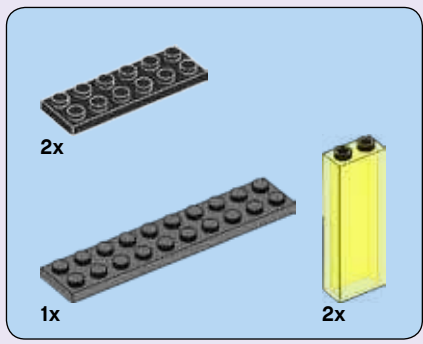

66

1

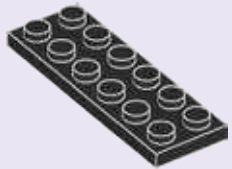

2

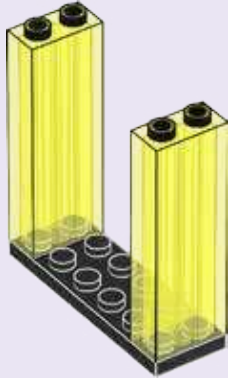

3

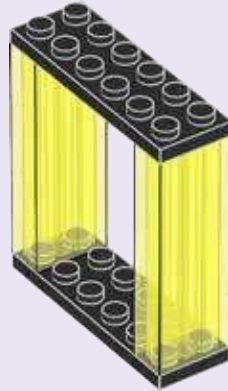

4

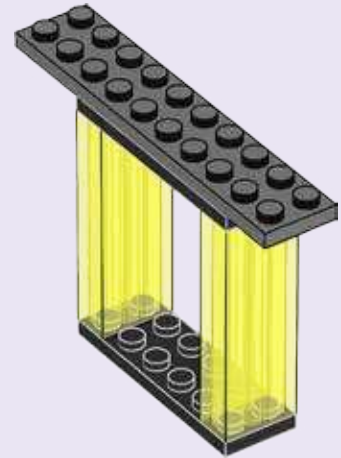

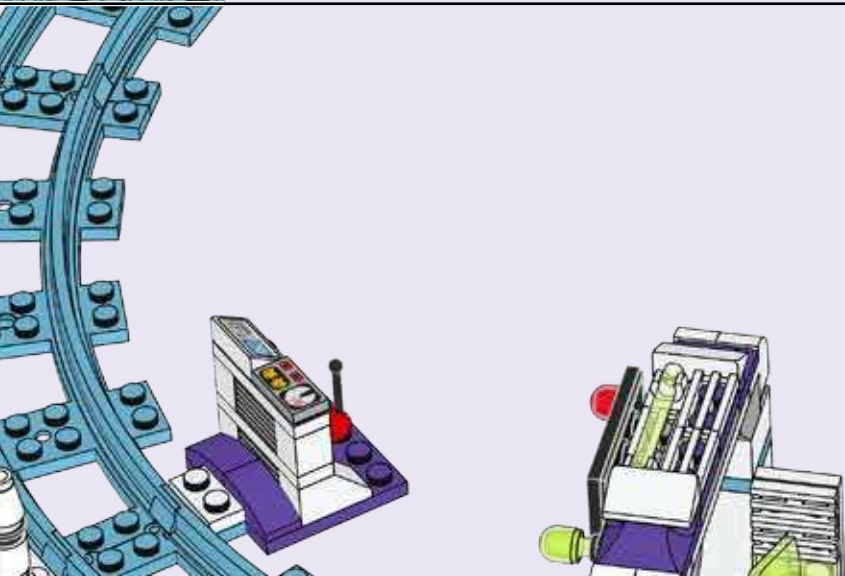
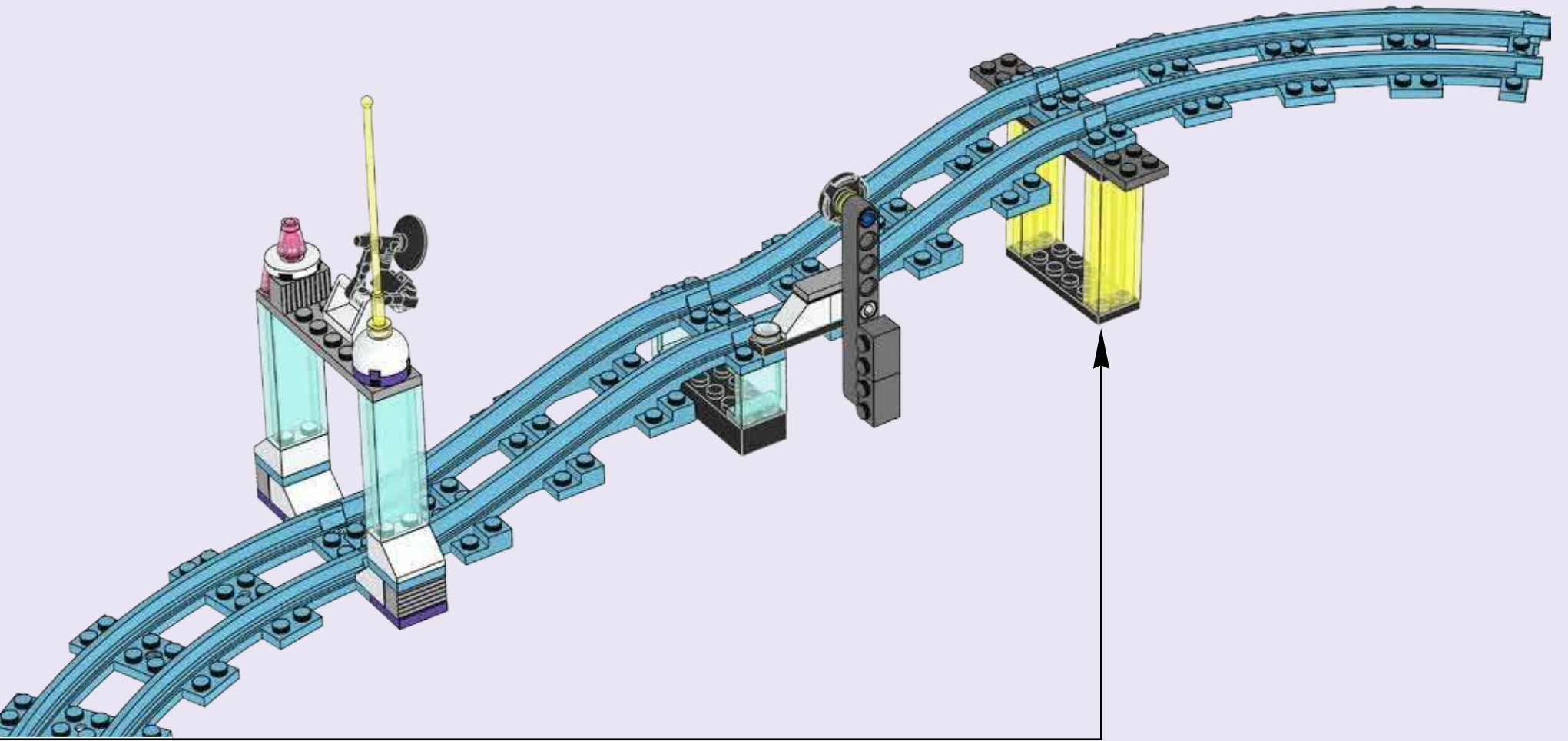

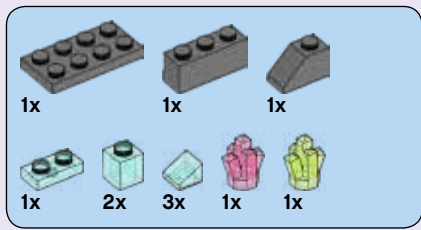

67

1



2

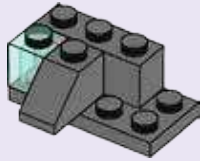

3



4



5



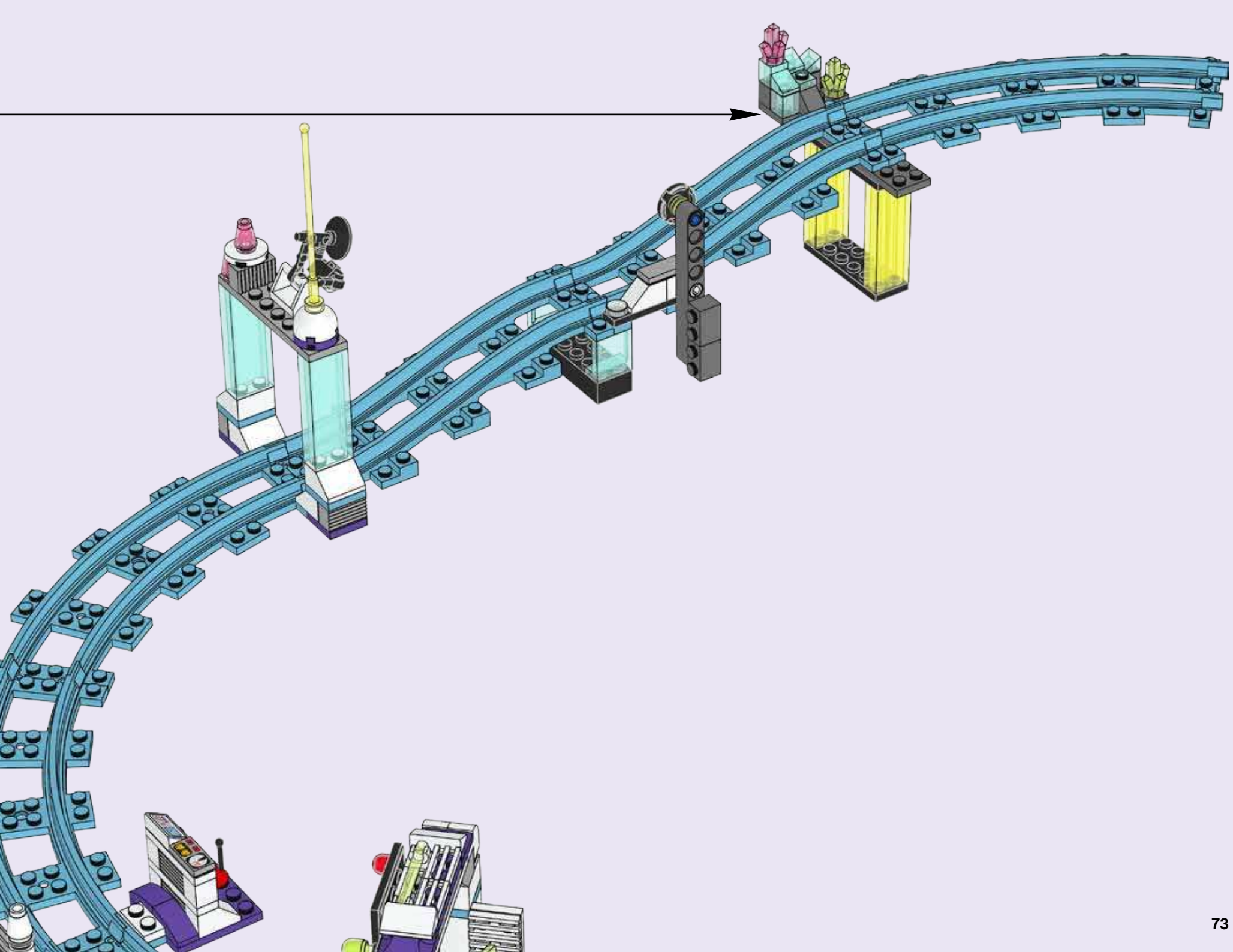

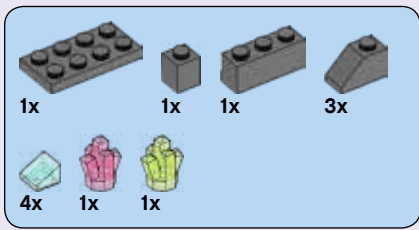

68

1



2

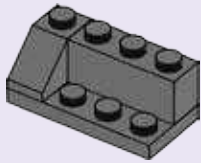

3

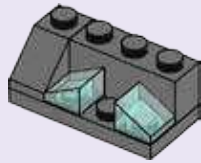

4

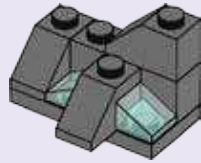

5



6

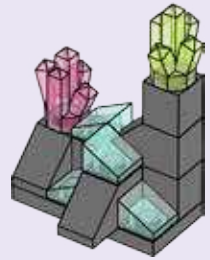

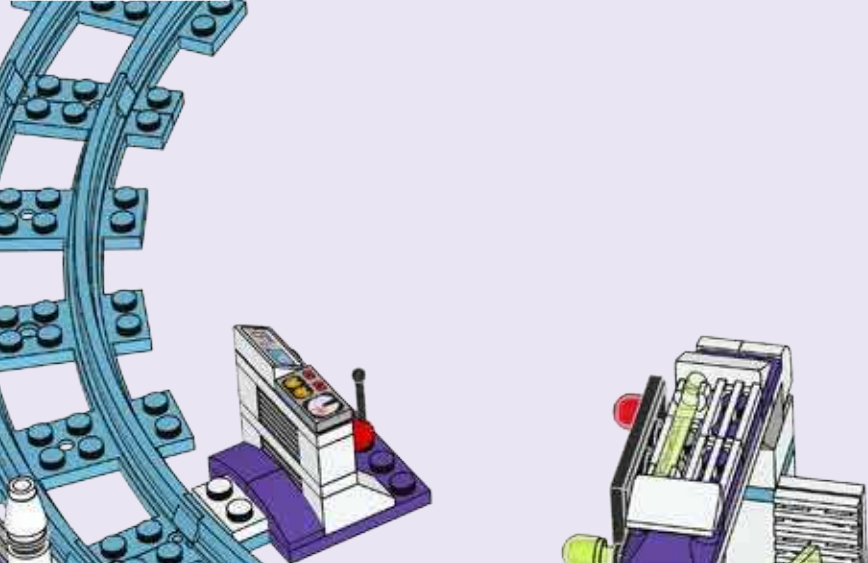
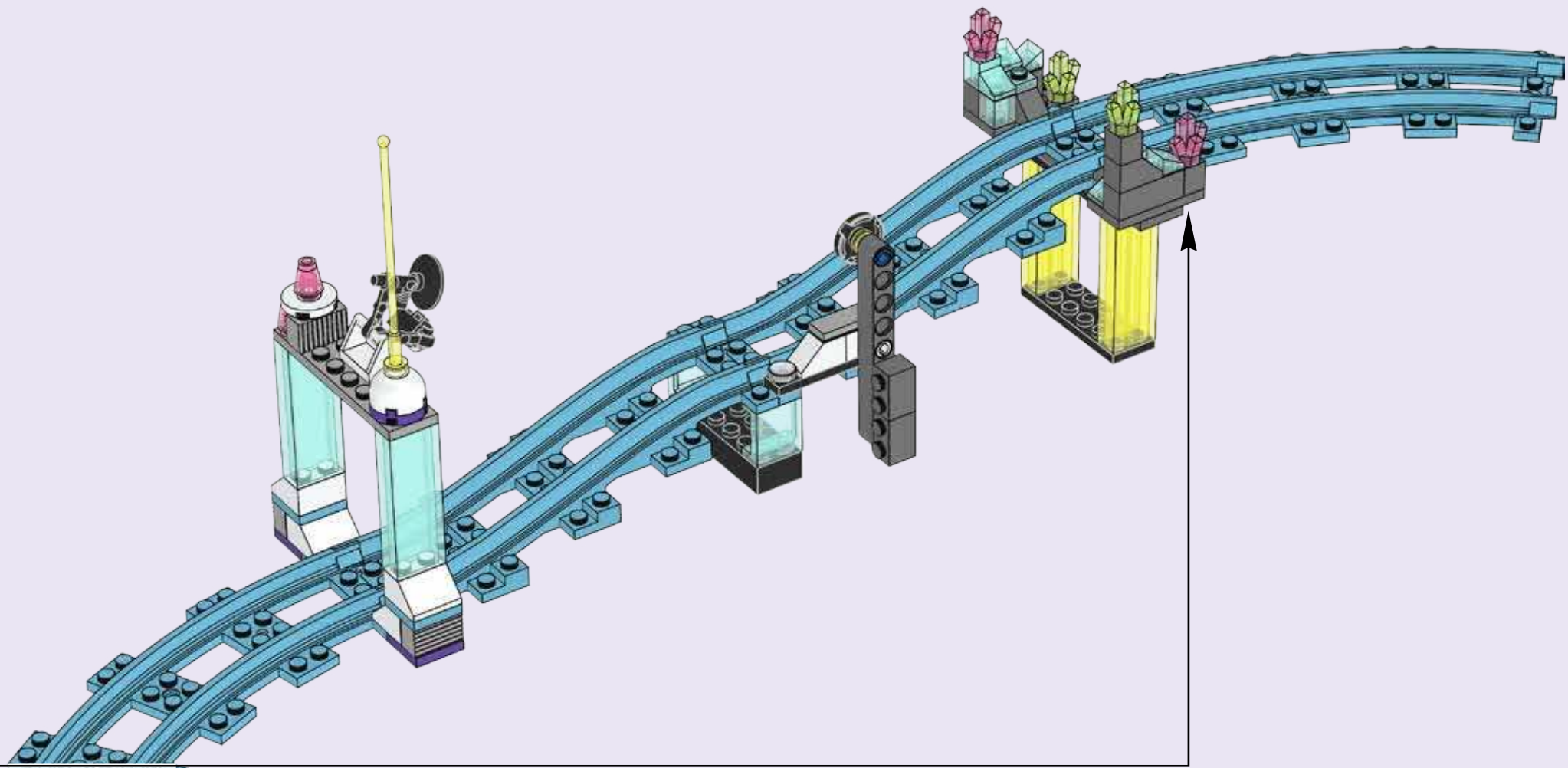

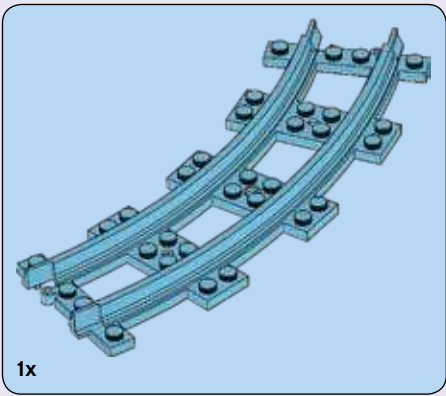

69

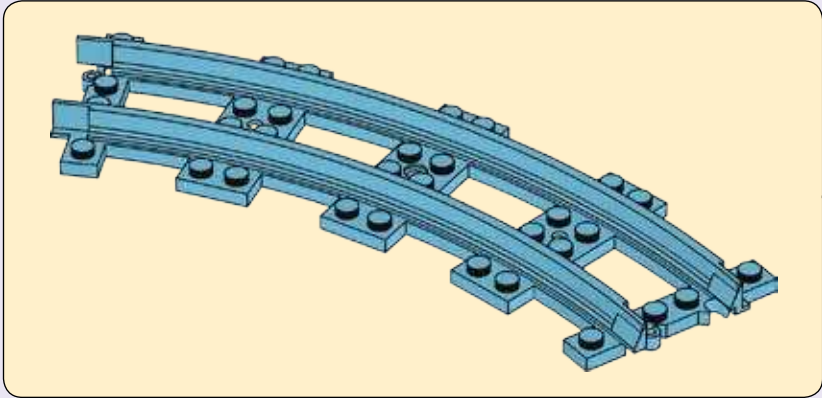
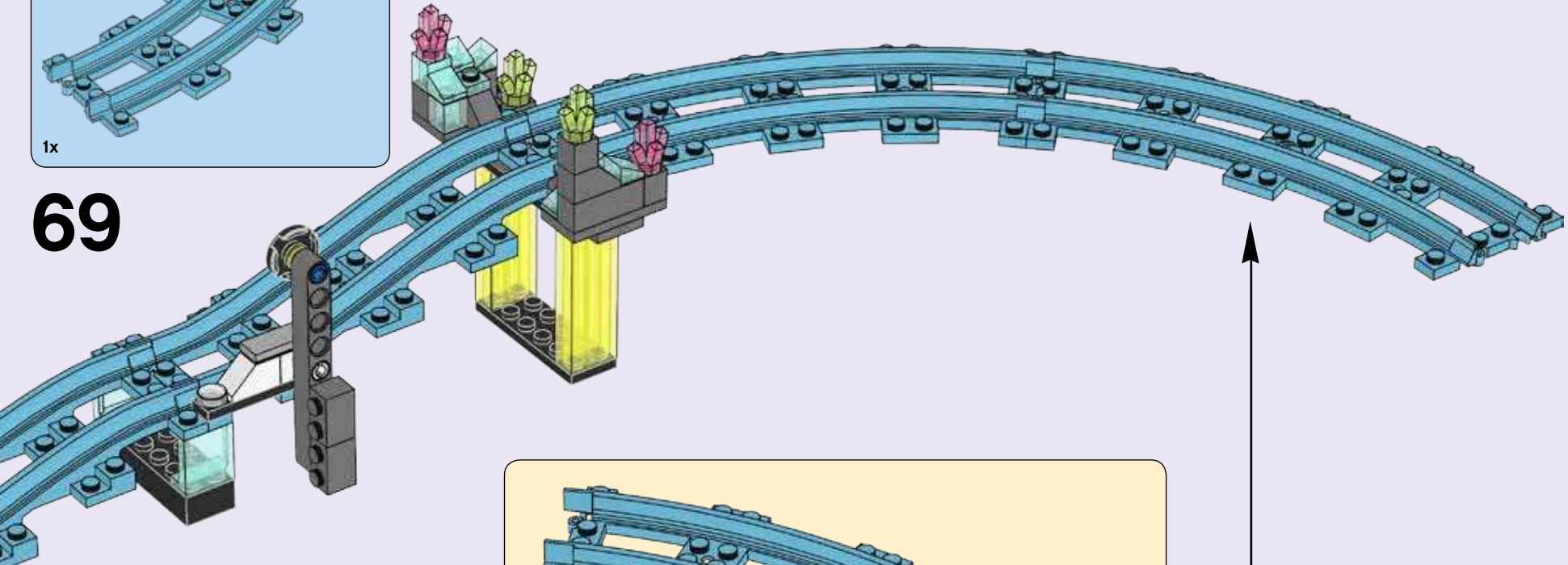

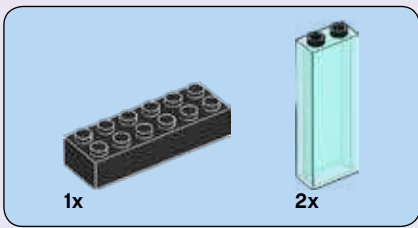

70

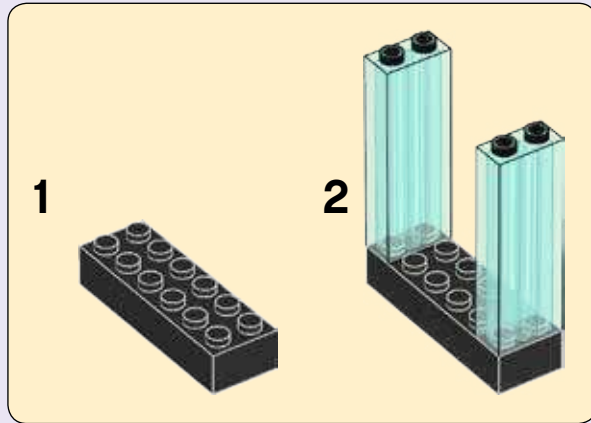
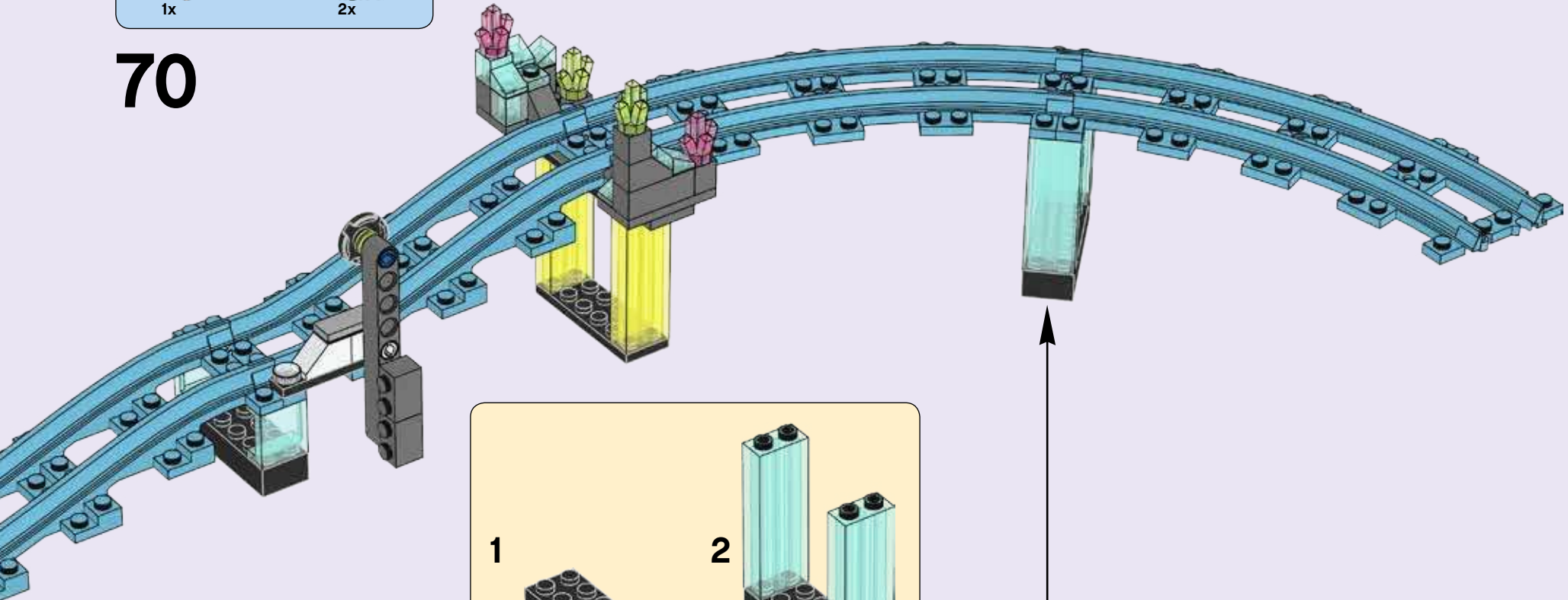

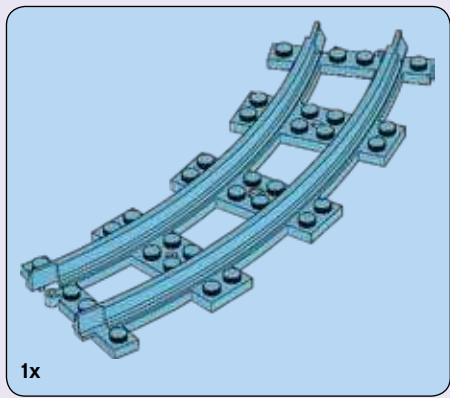

71

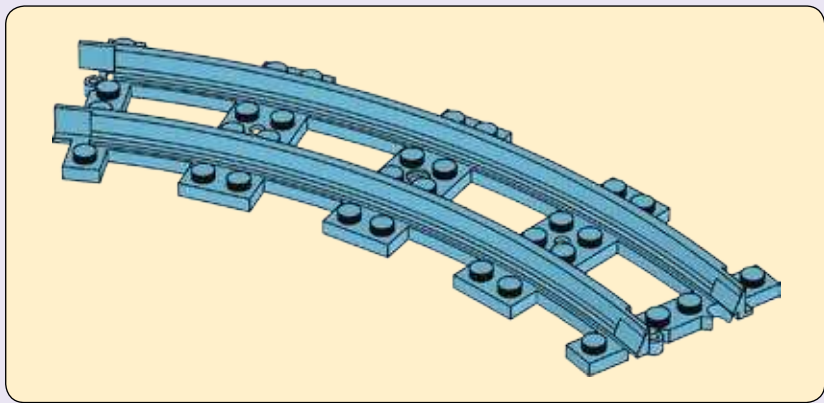
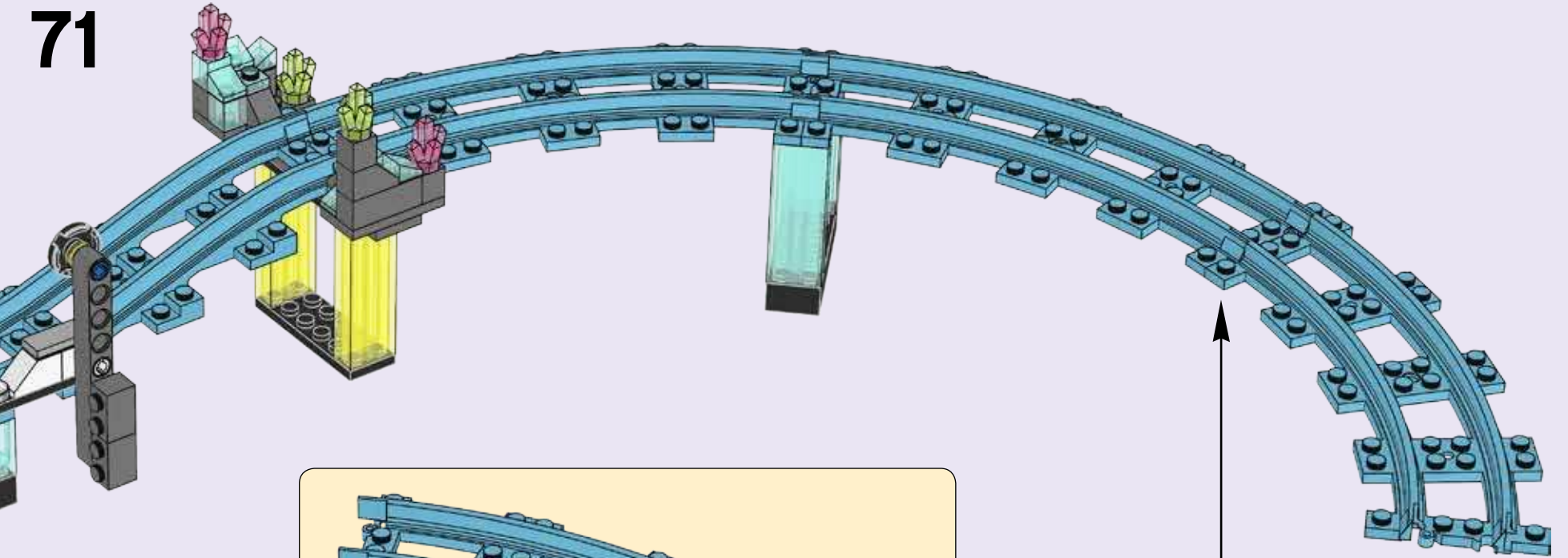

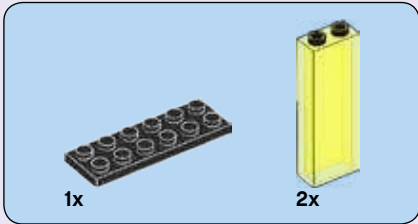
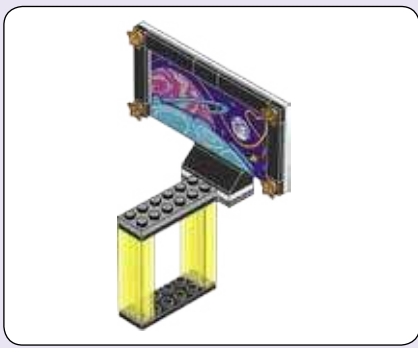

72

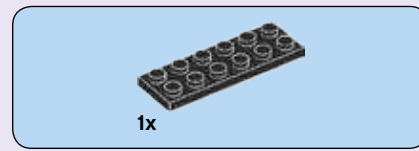
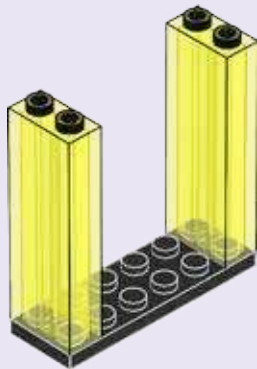

73

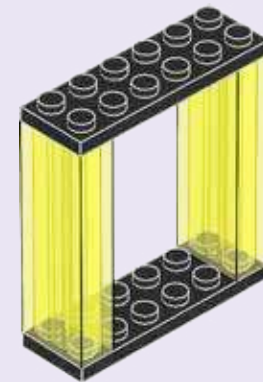

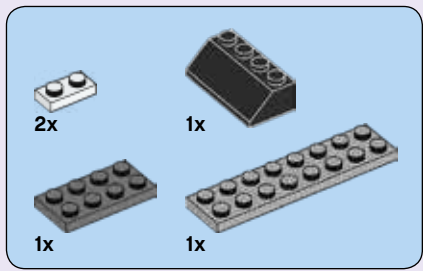

74

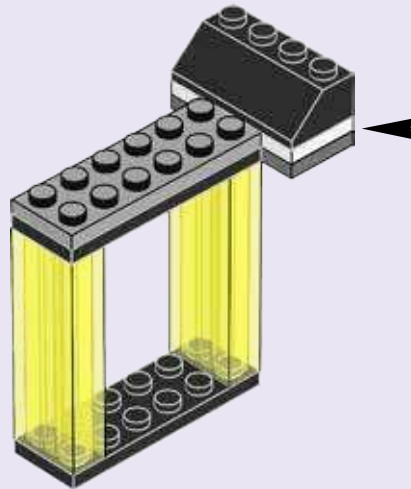
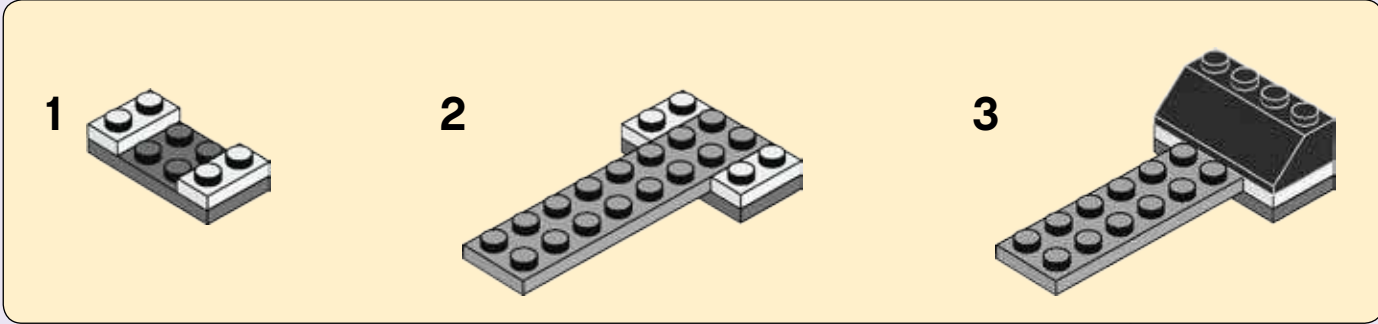

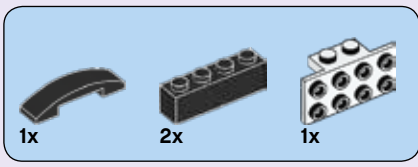

75

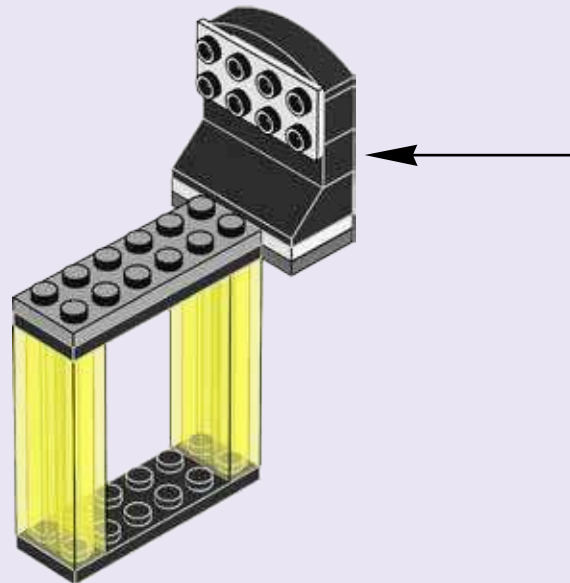
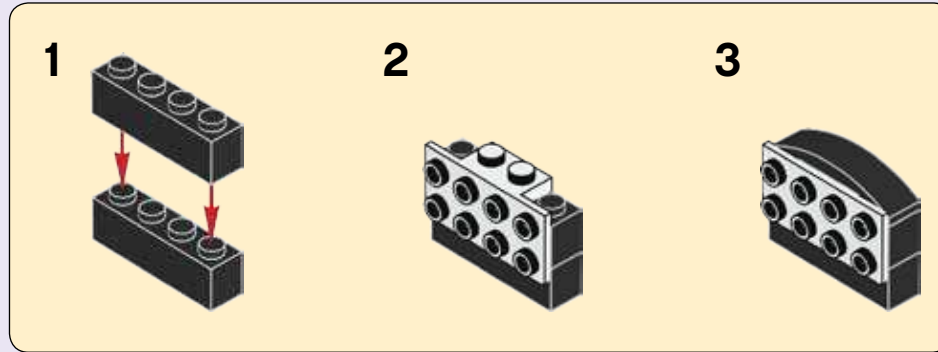

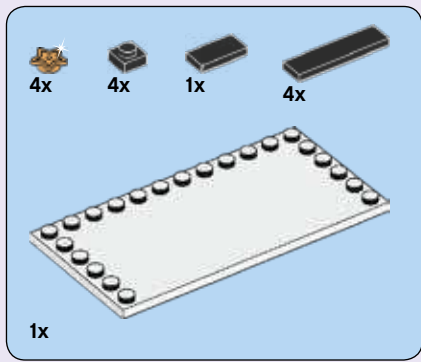

76

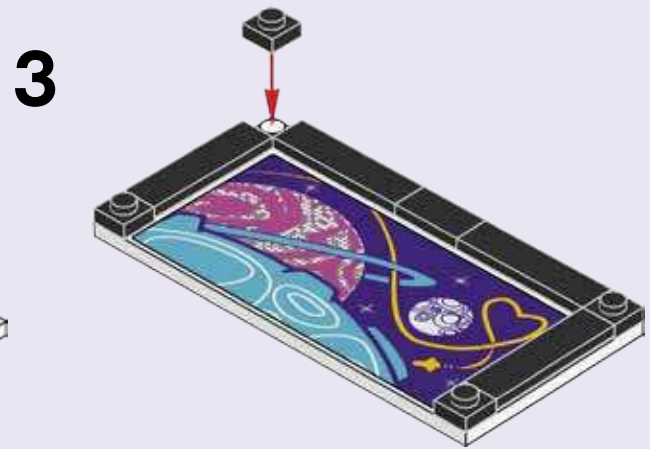
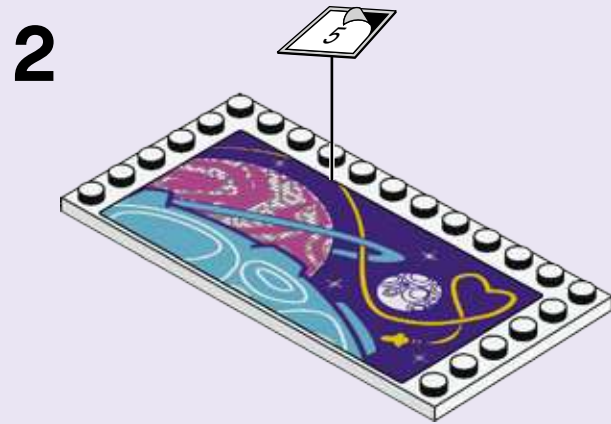
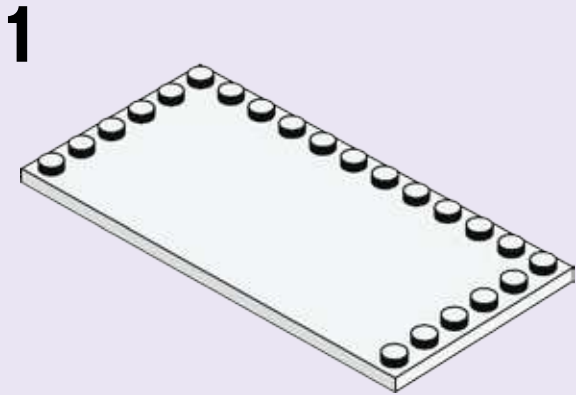

4

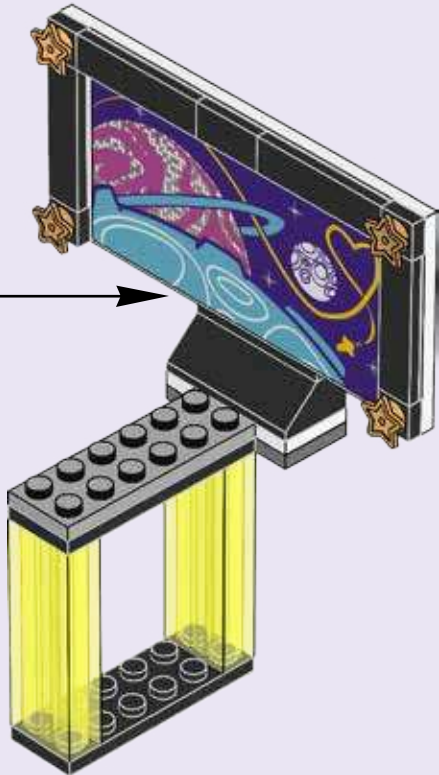

77

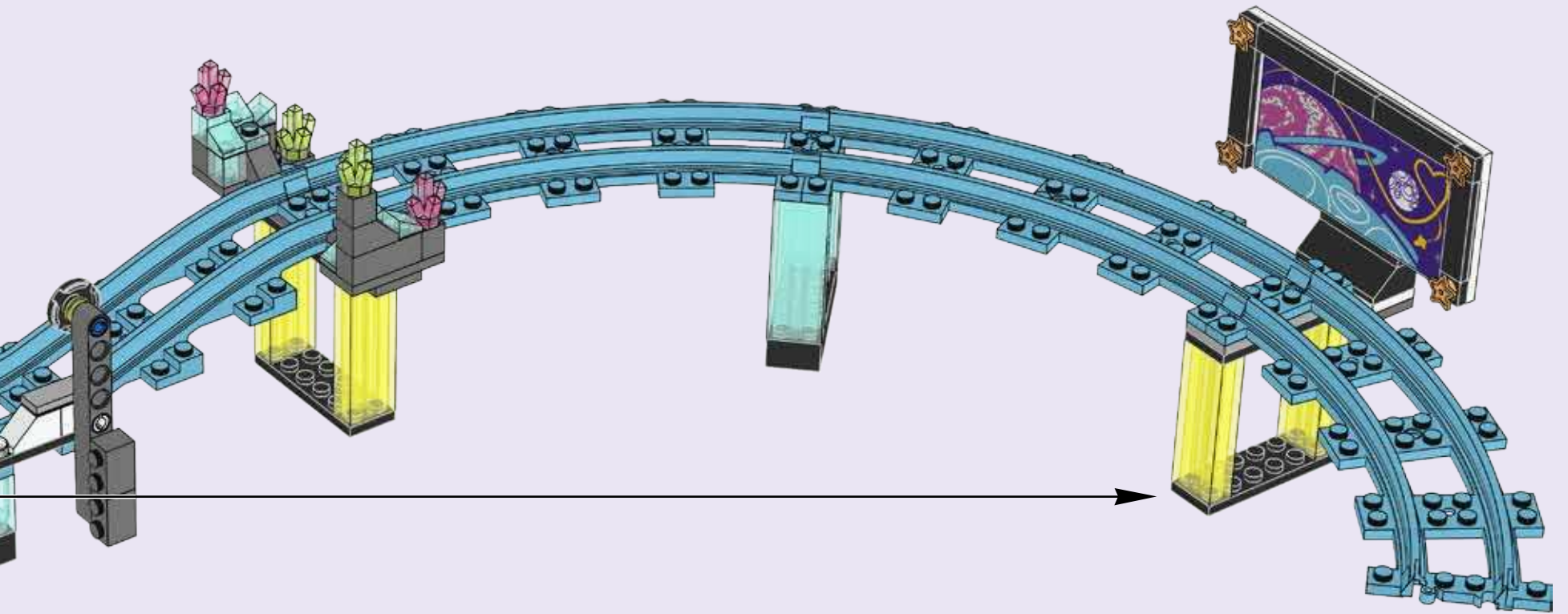

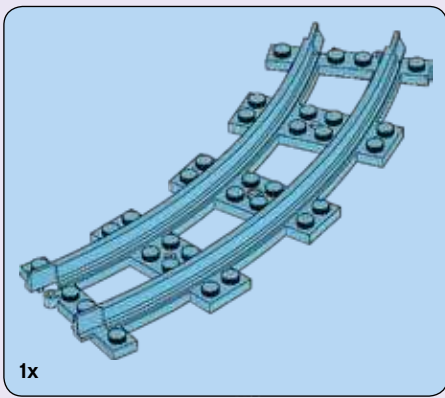

78

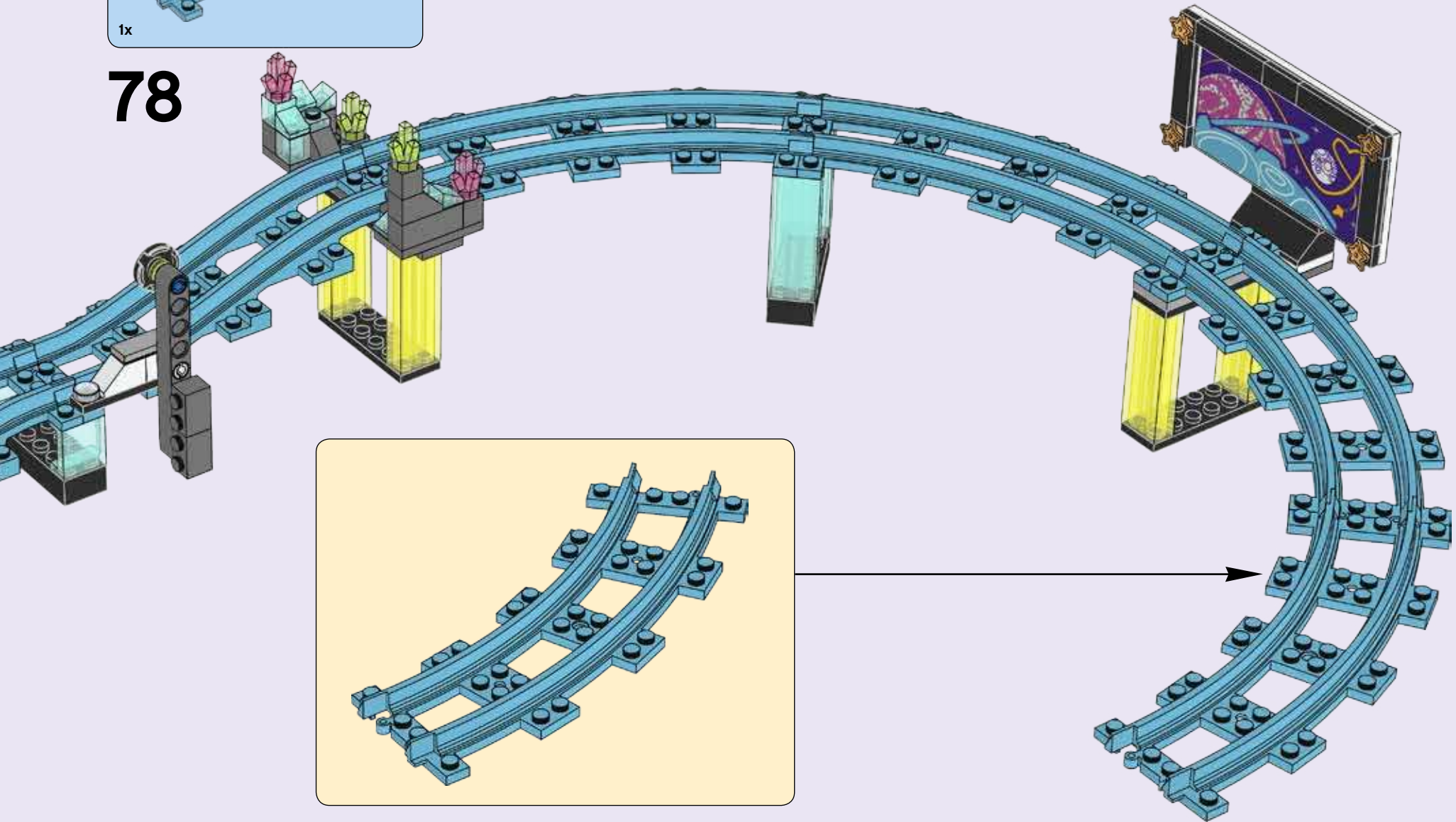

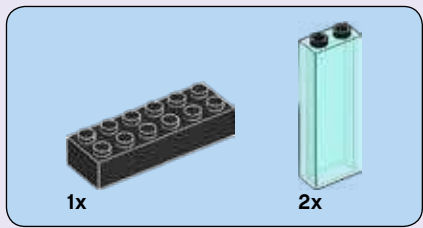

79

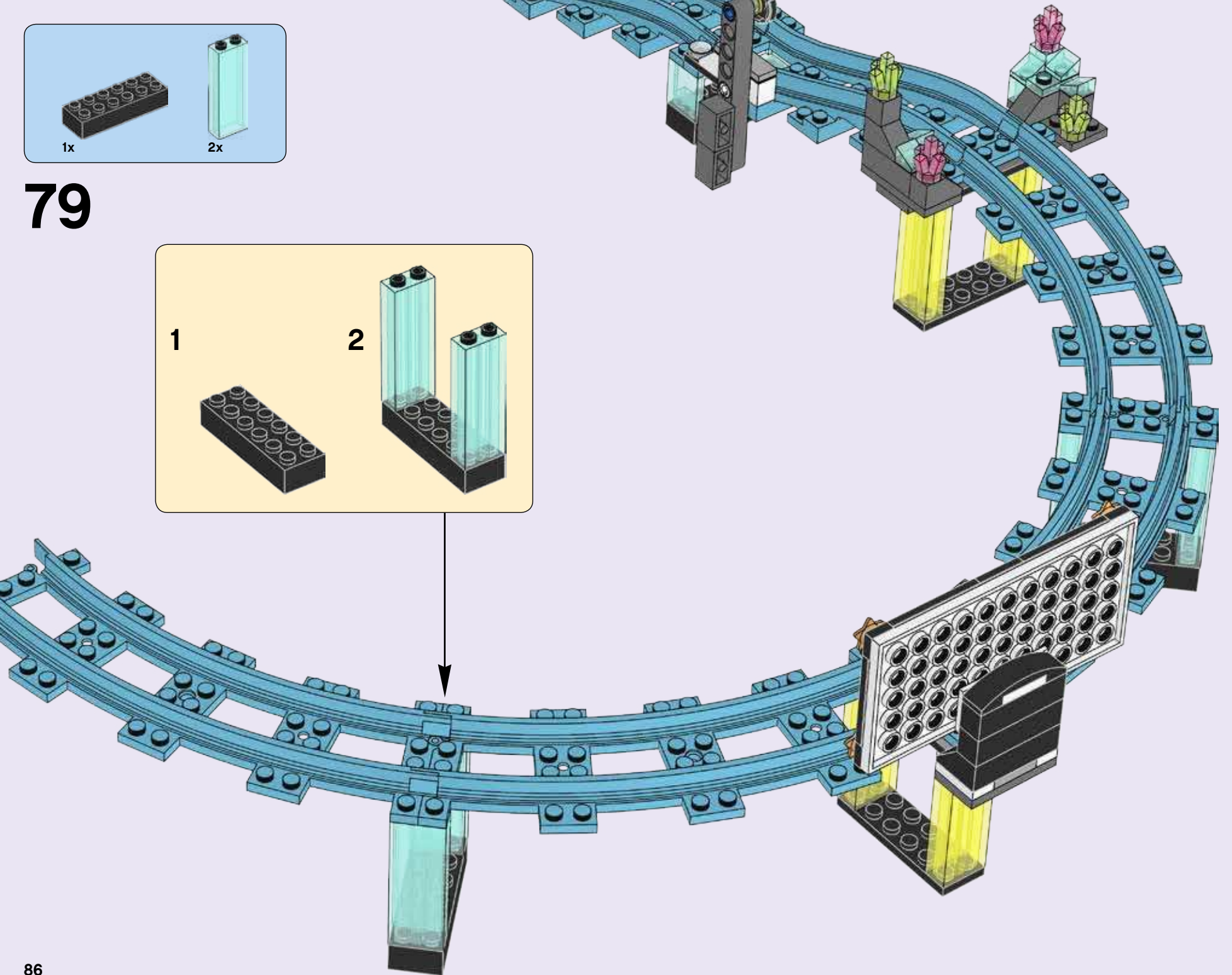
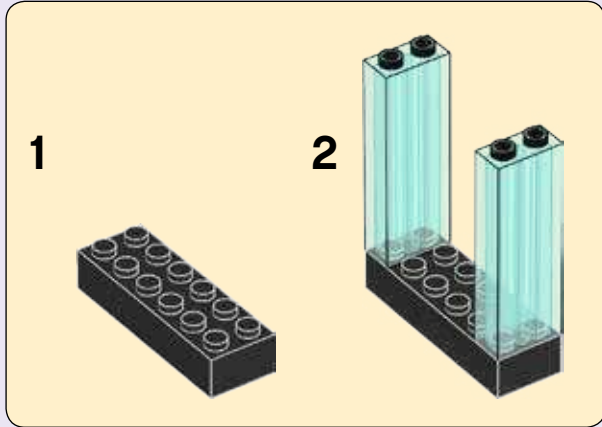

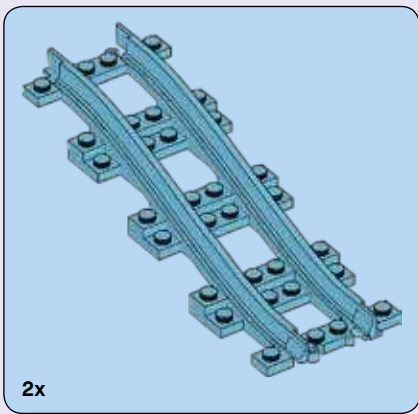

80

1

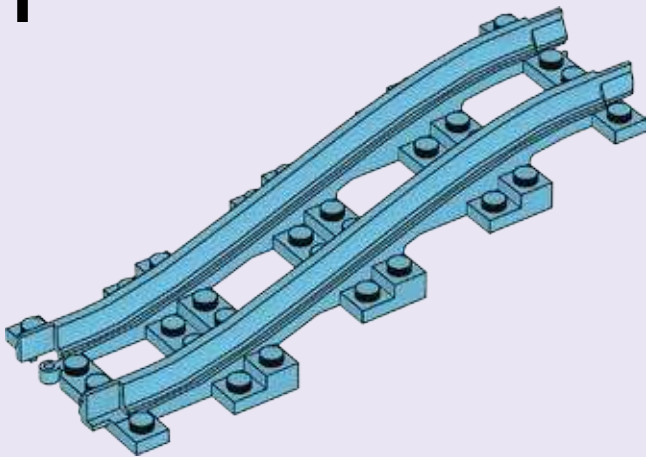

2

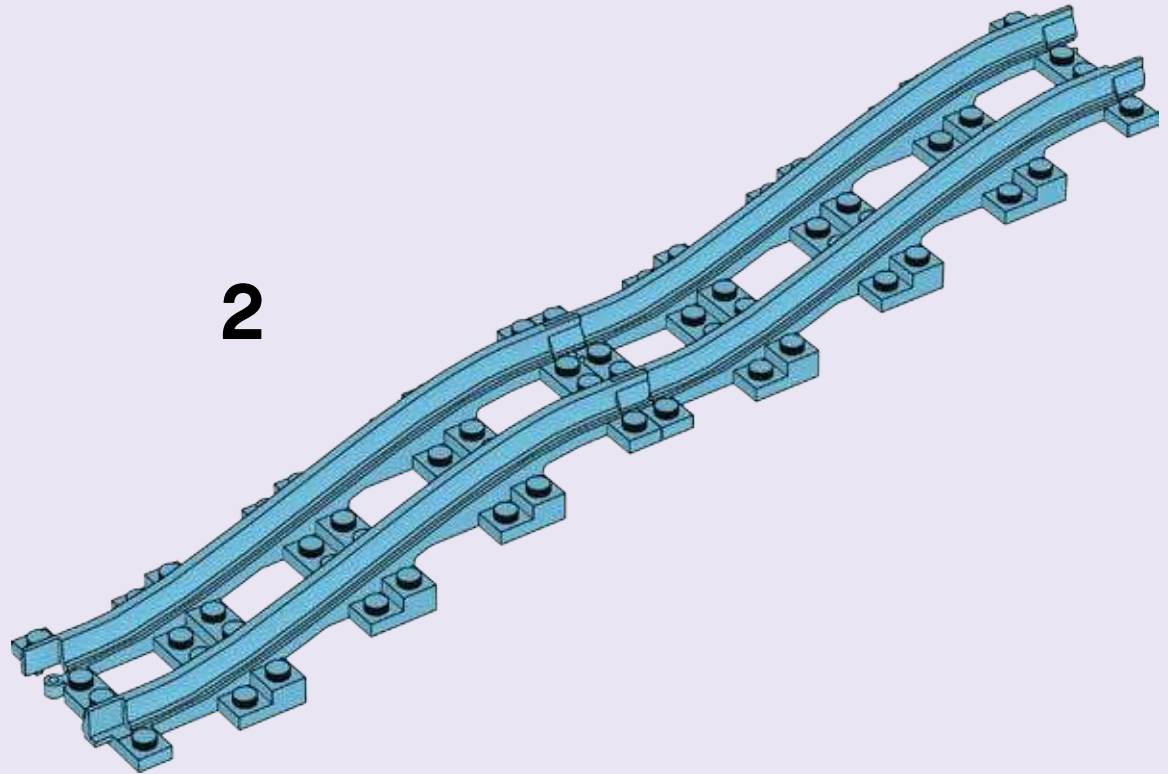

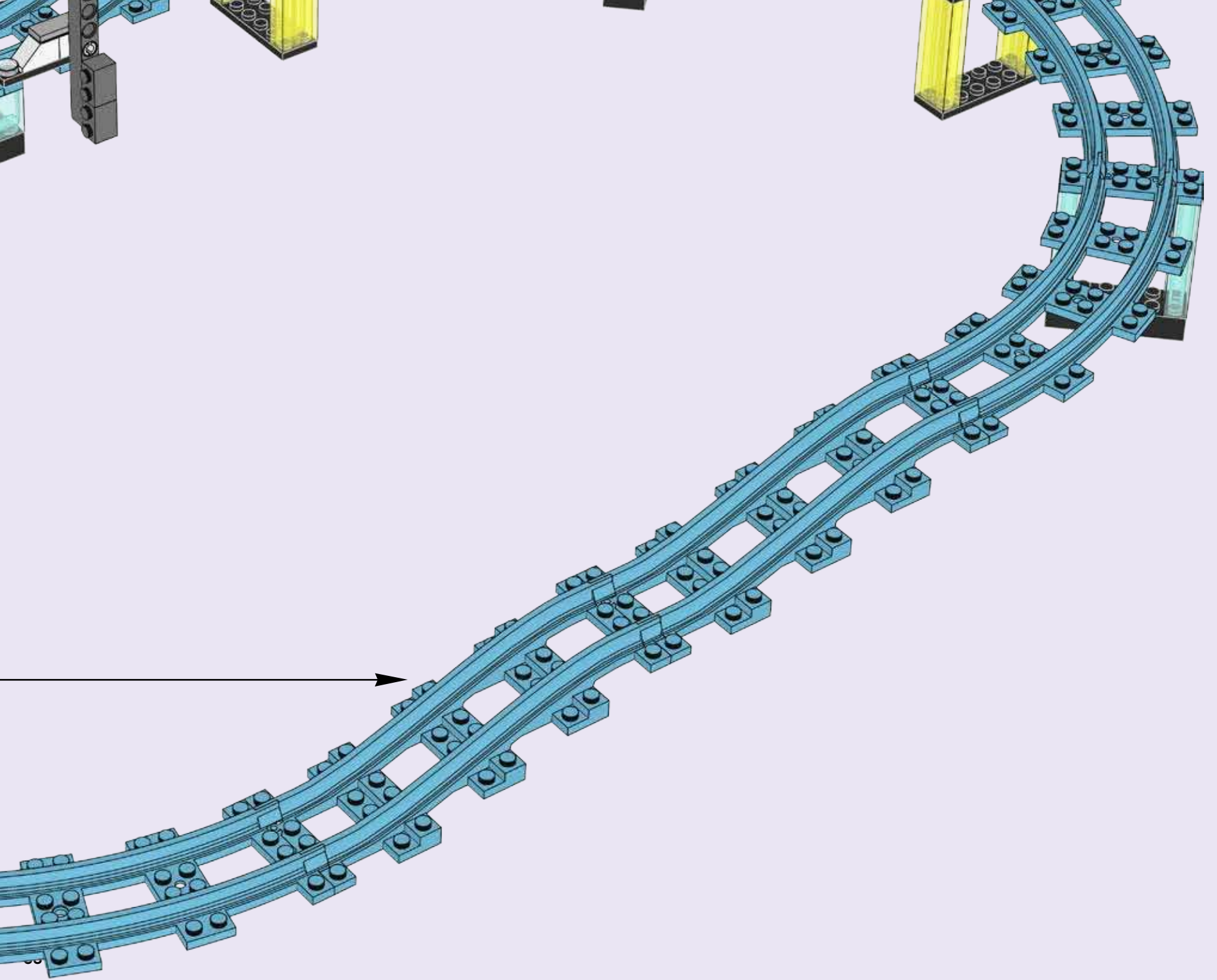

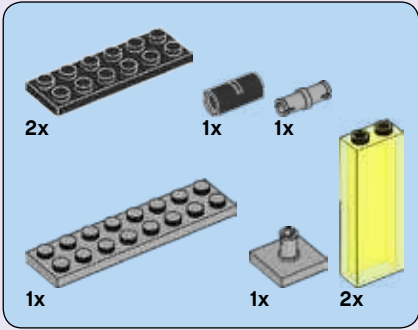

81

1

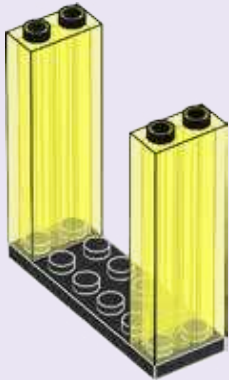

2

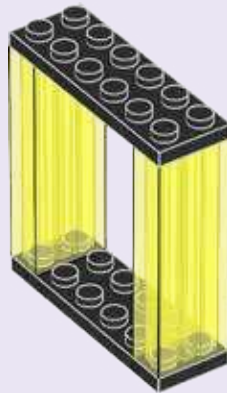

3



4

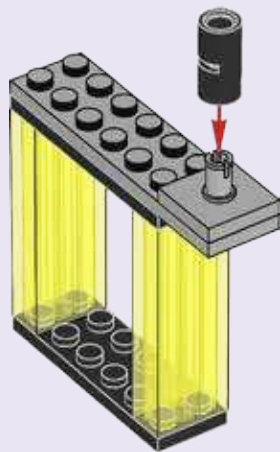

5

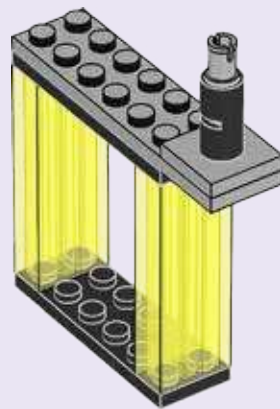

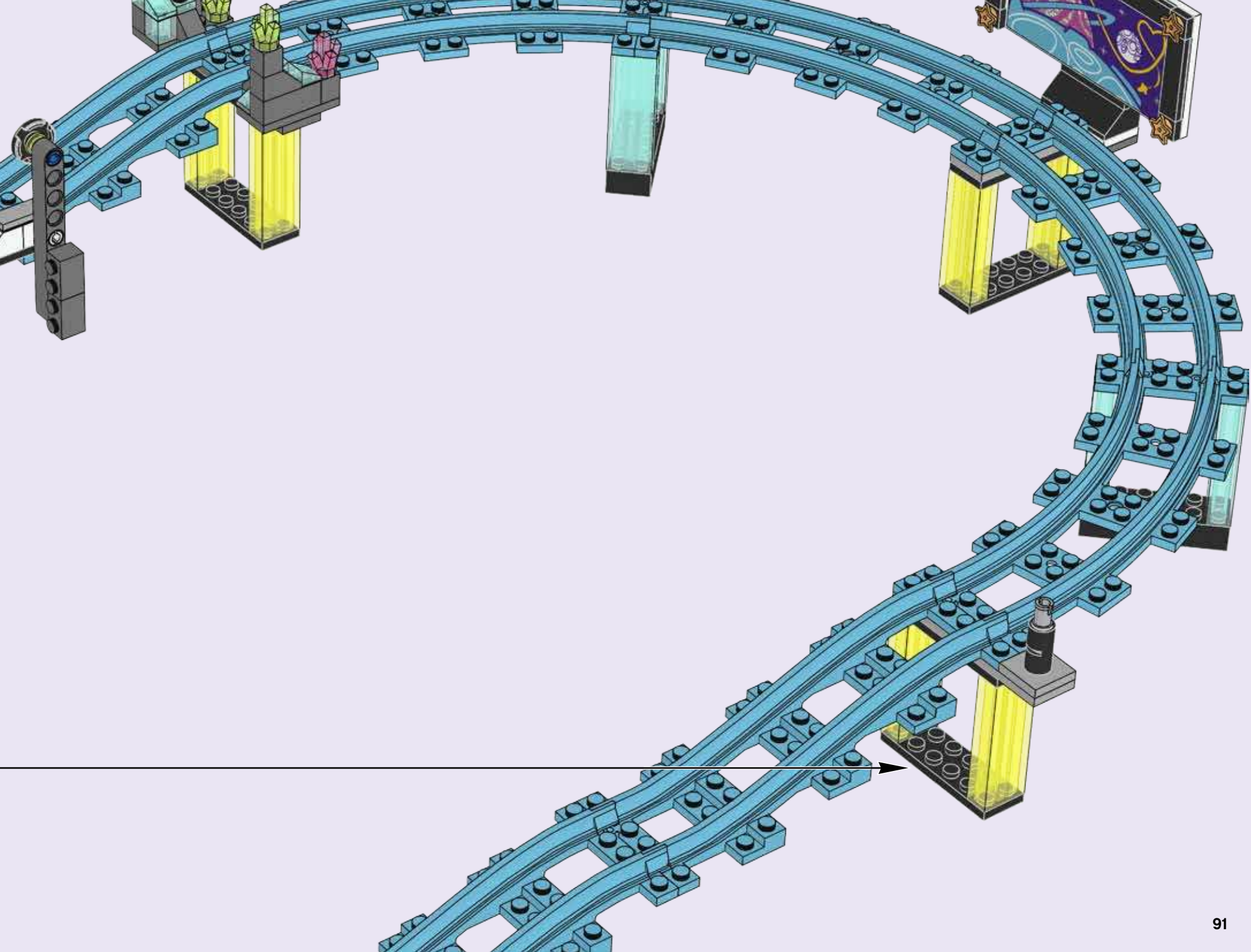

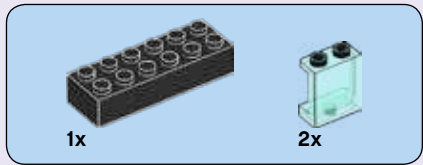

82

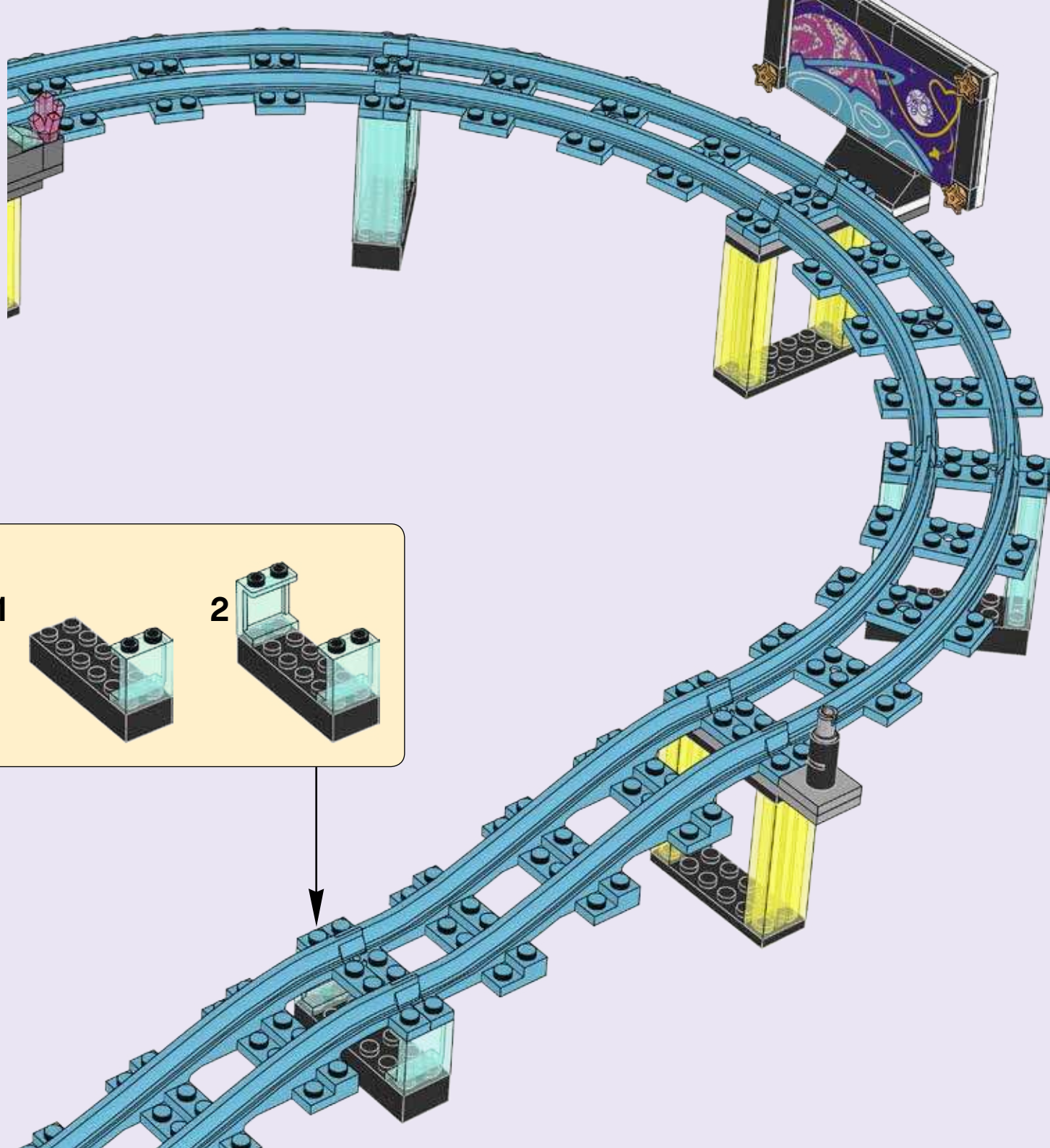

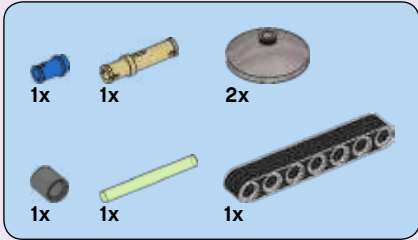

83

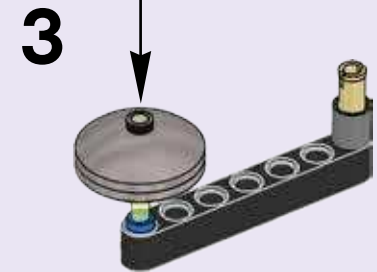
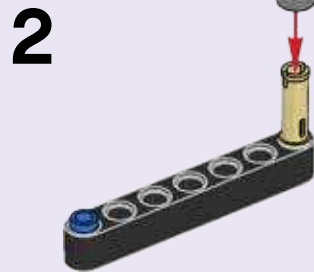
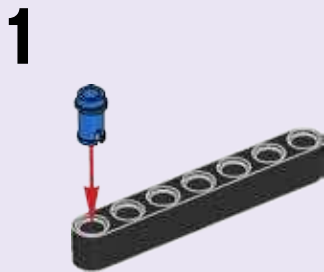
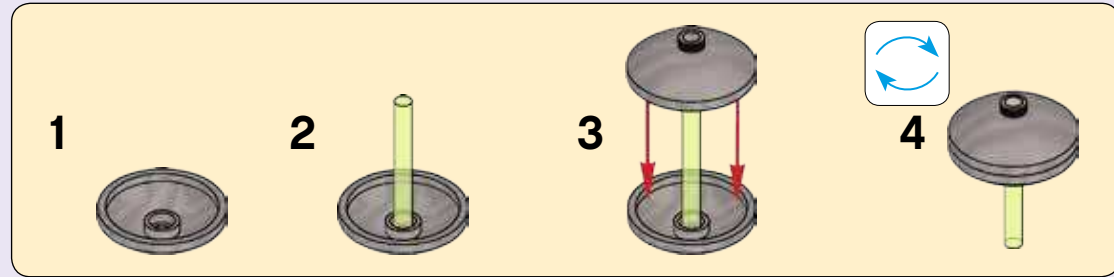

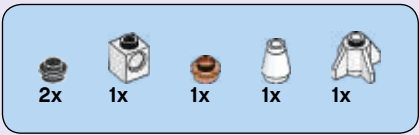

84

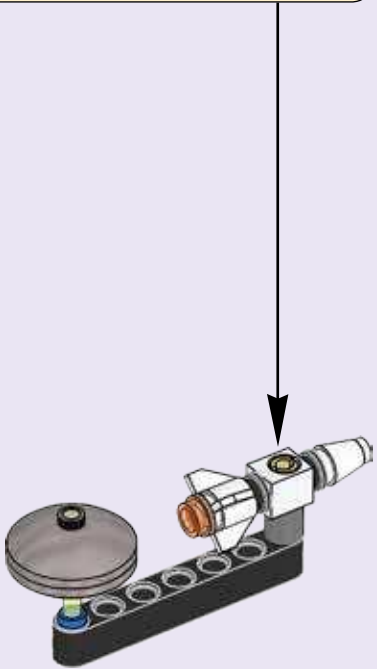
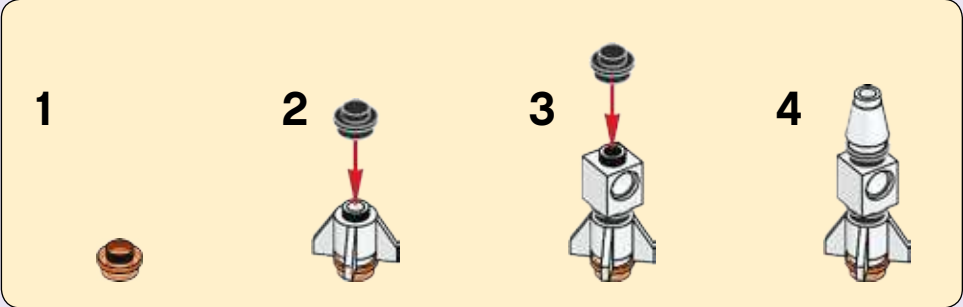

85

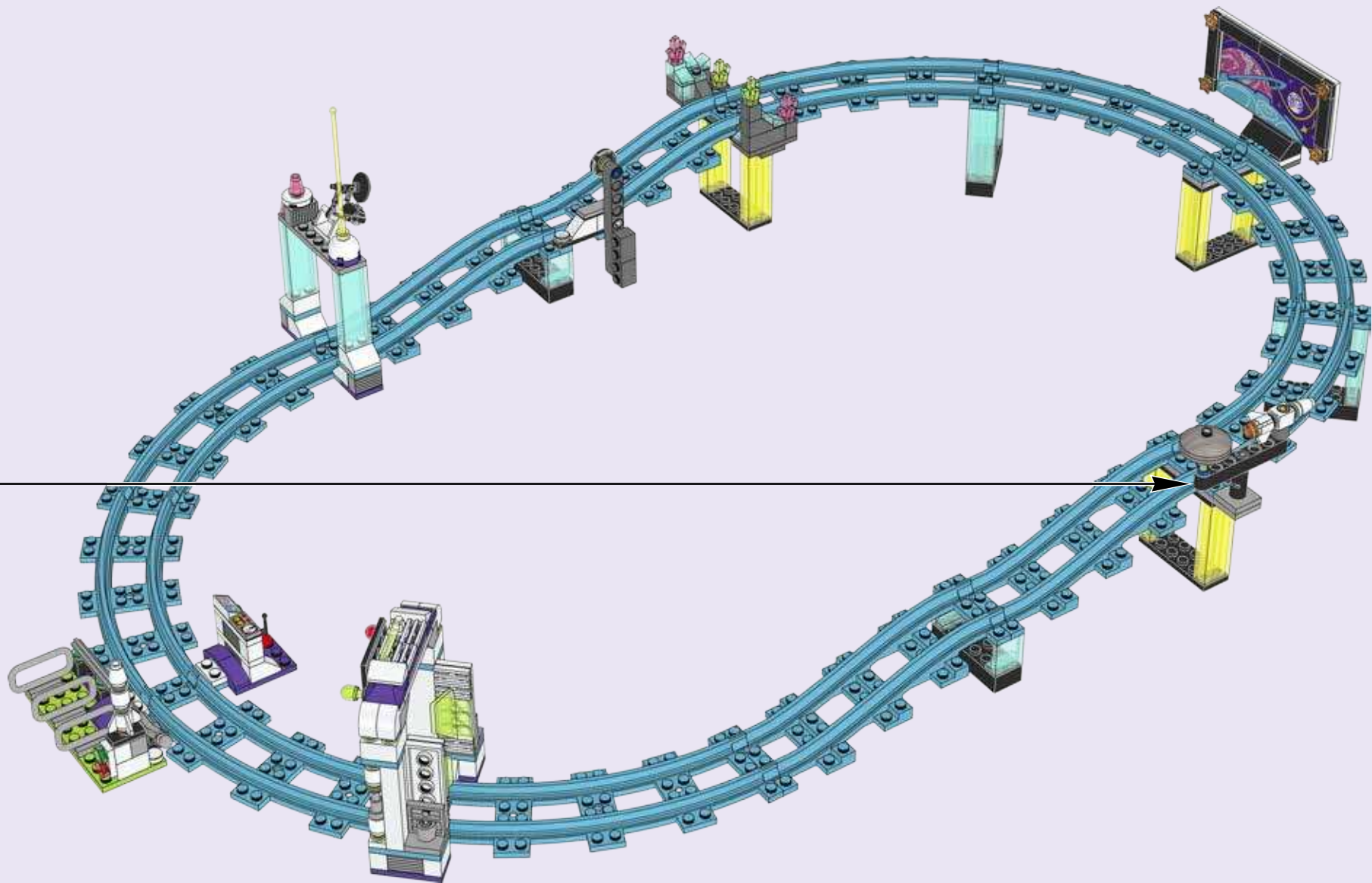

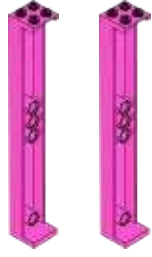
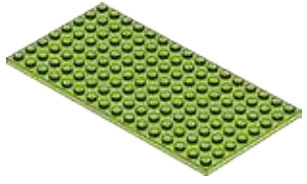

+

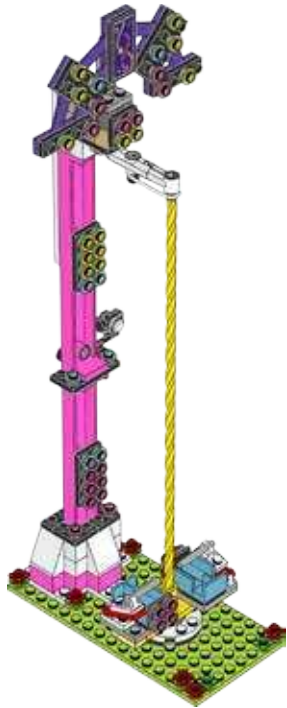
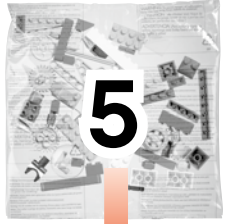

1

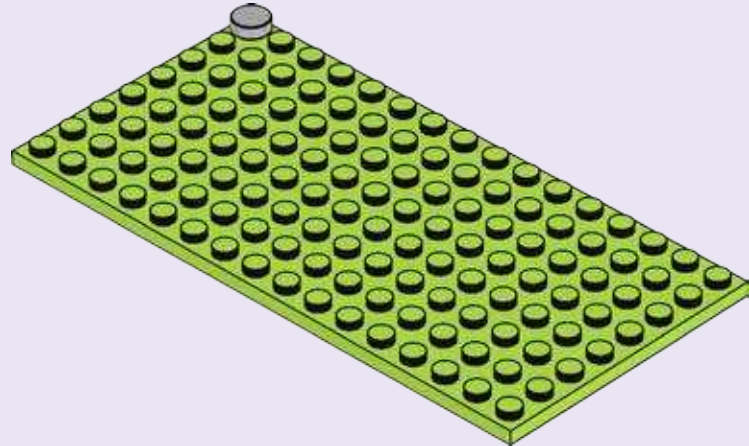



2

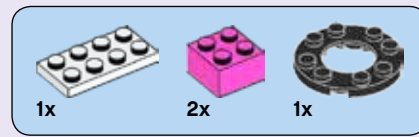
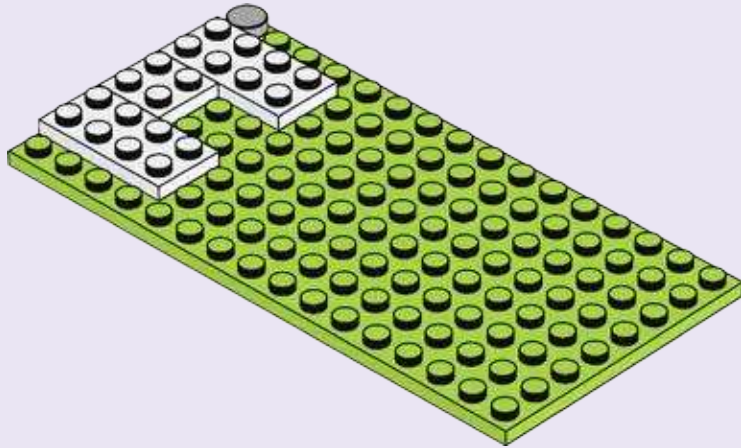

3

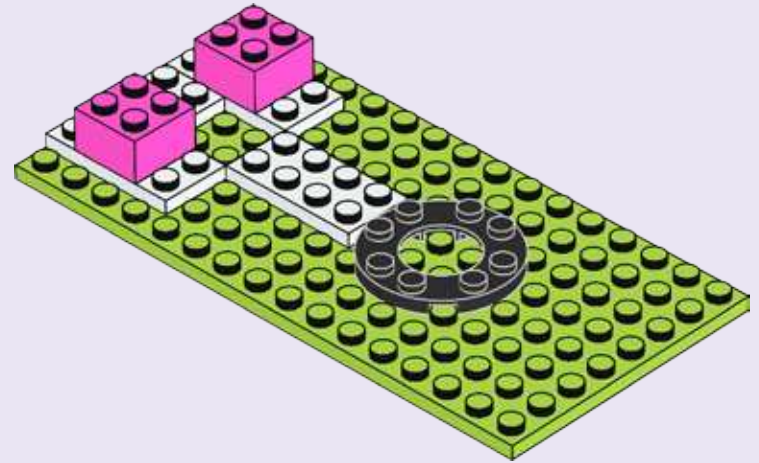

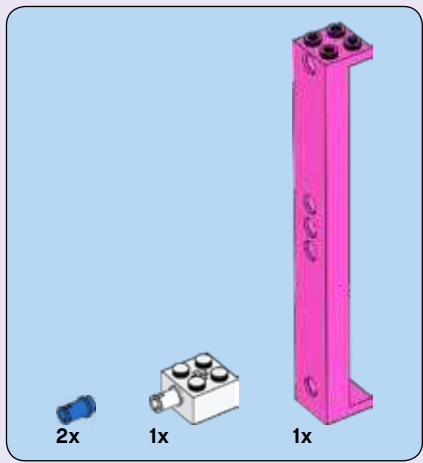

4

1

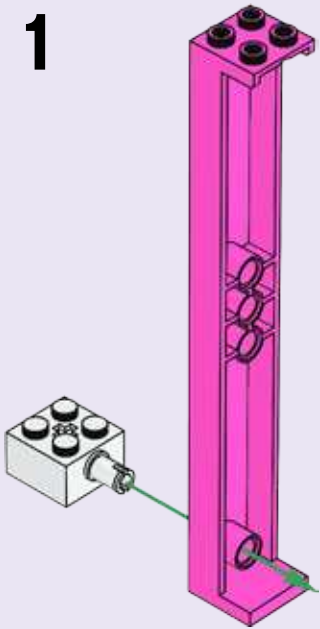

2

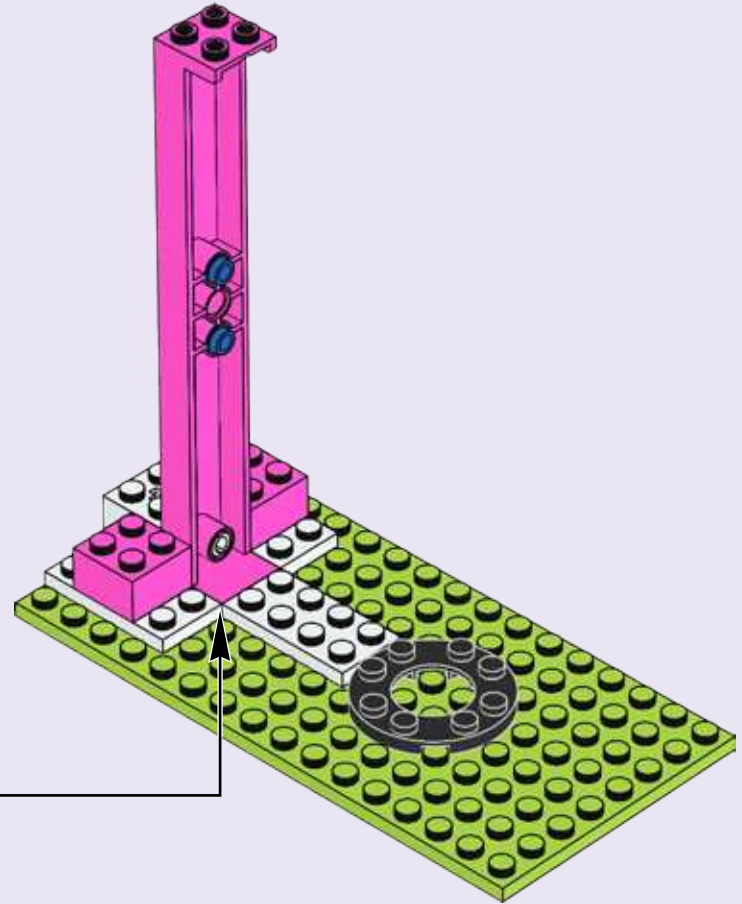
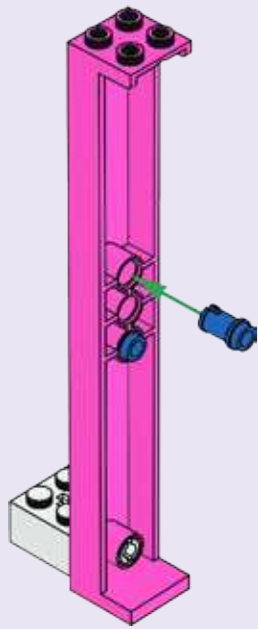

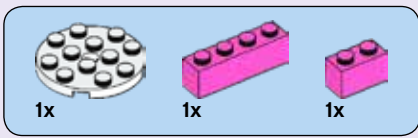

5

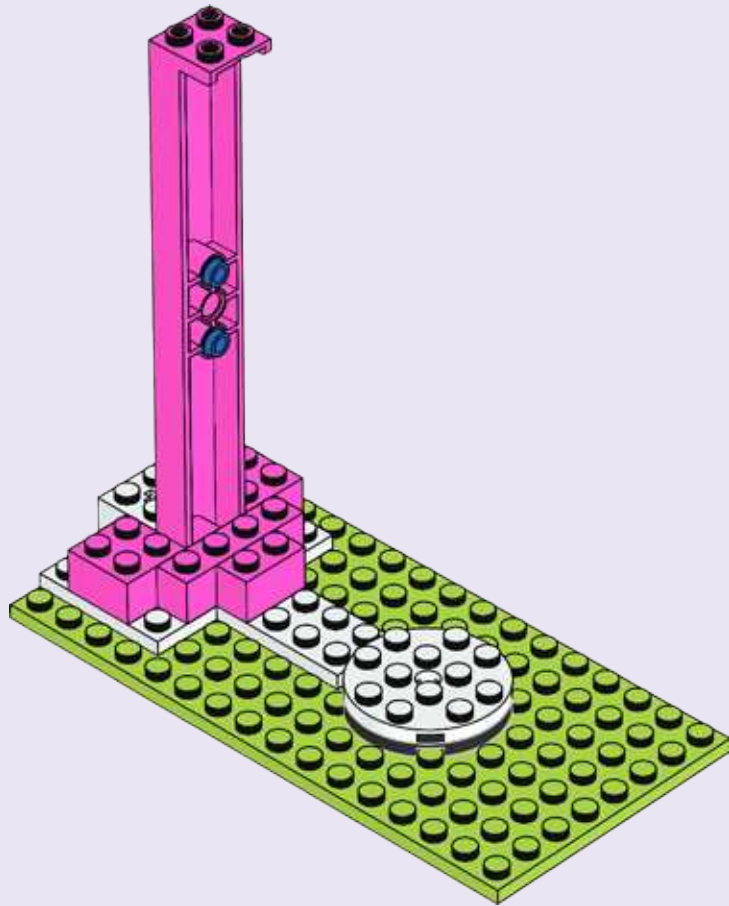

6

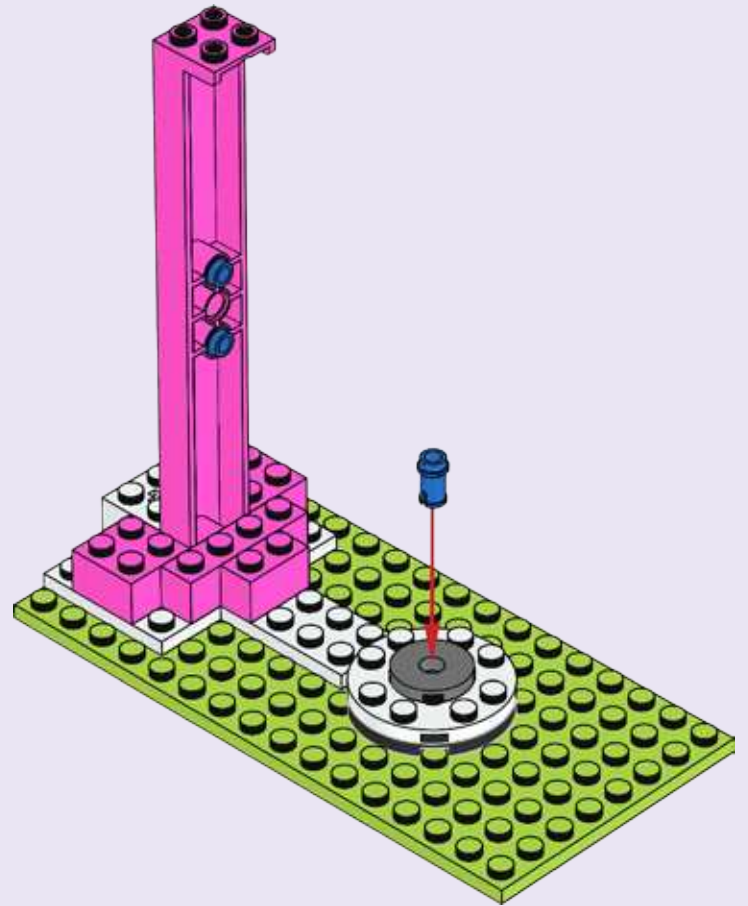

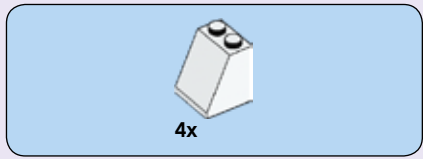

7

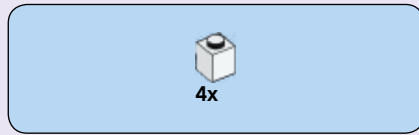
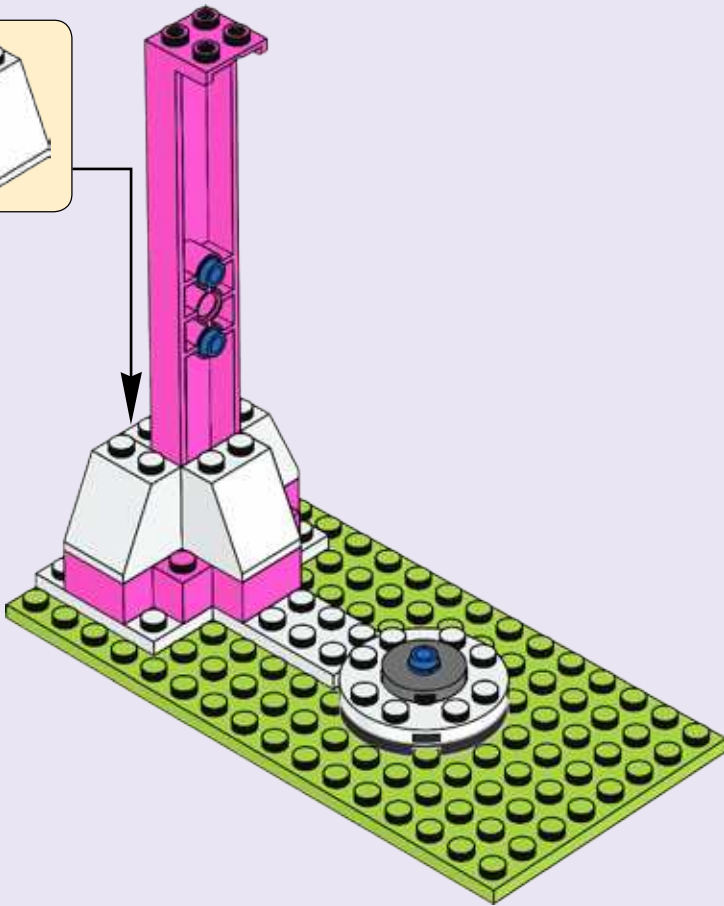
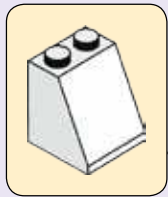

8

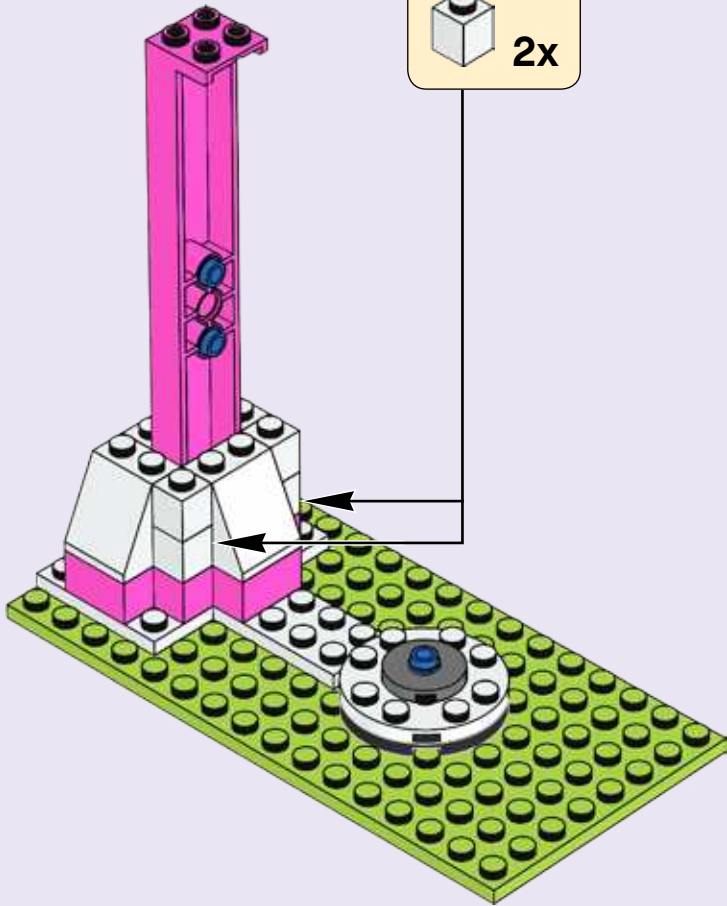
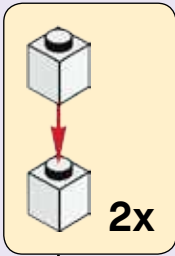

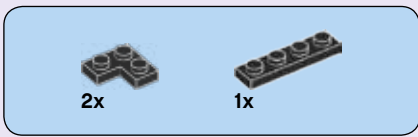

9

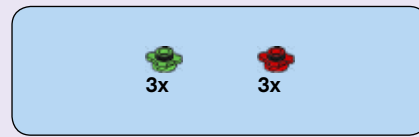
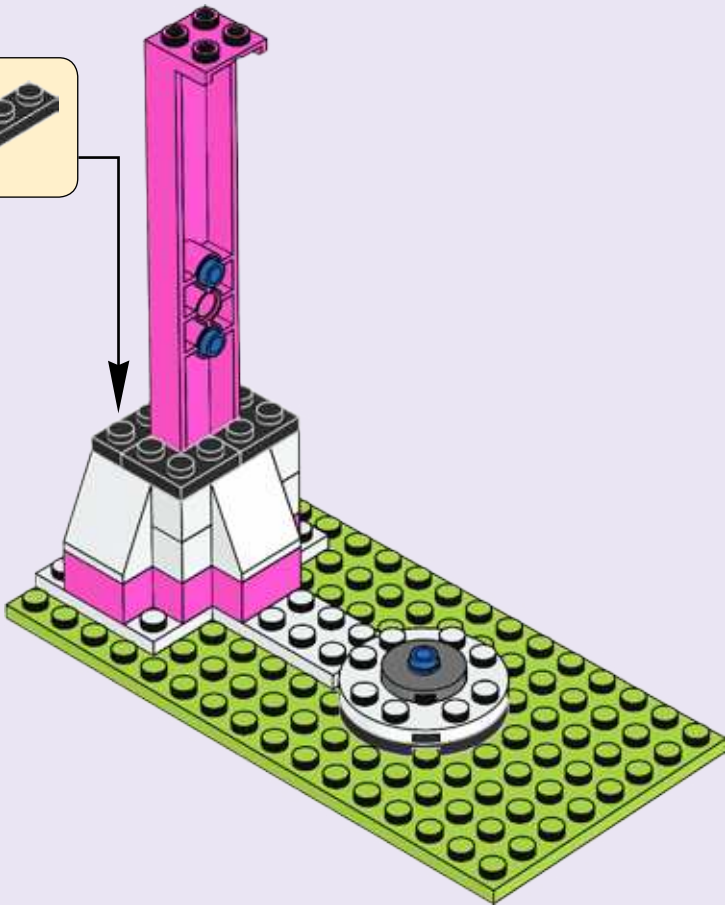
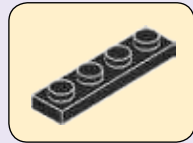

10

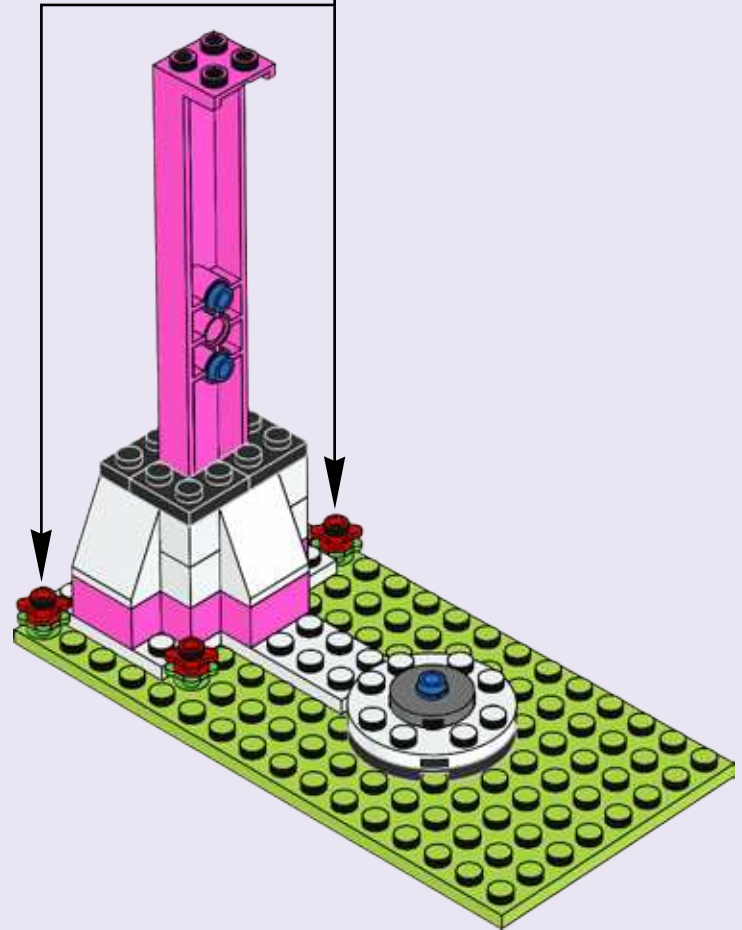
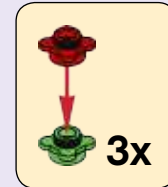



4x



1x

11

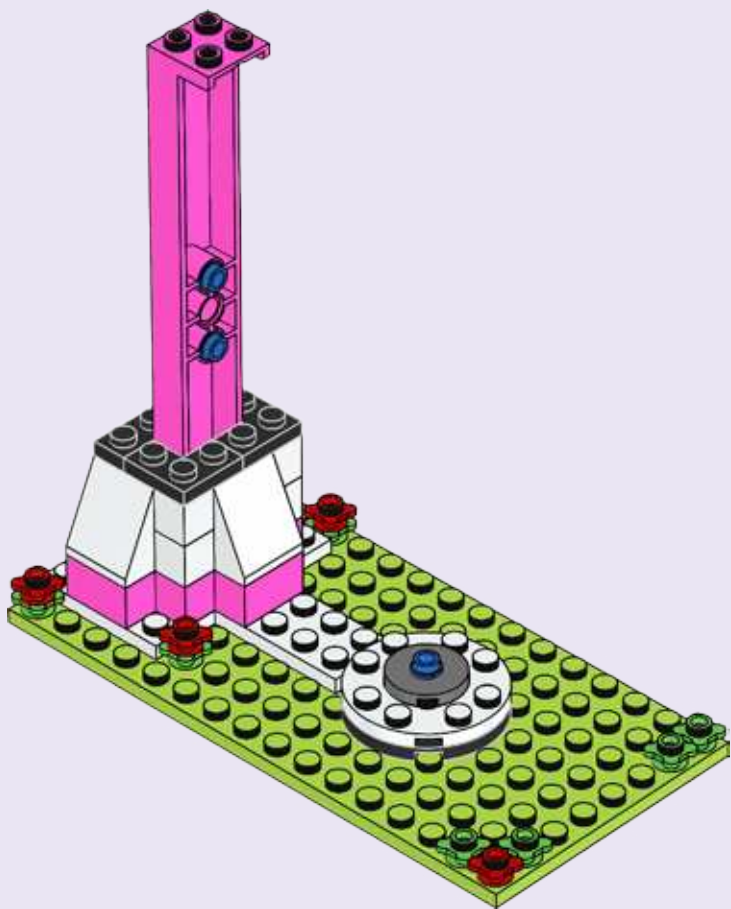

2x



2x

12





13

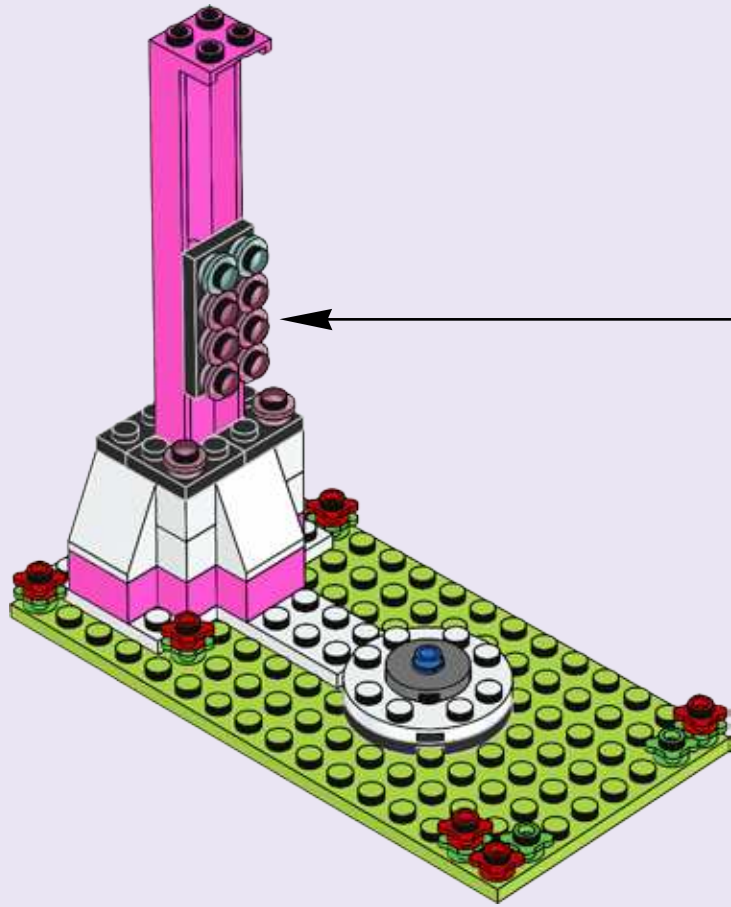
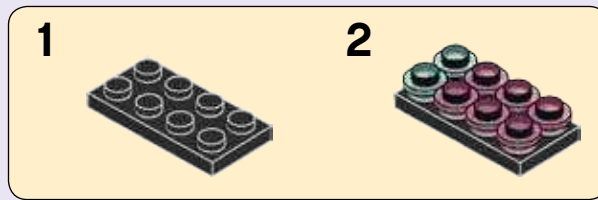

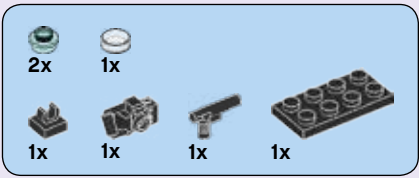

14

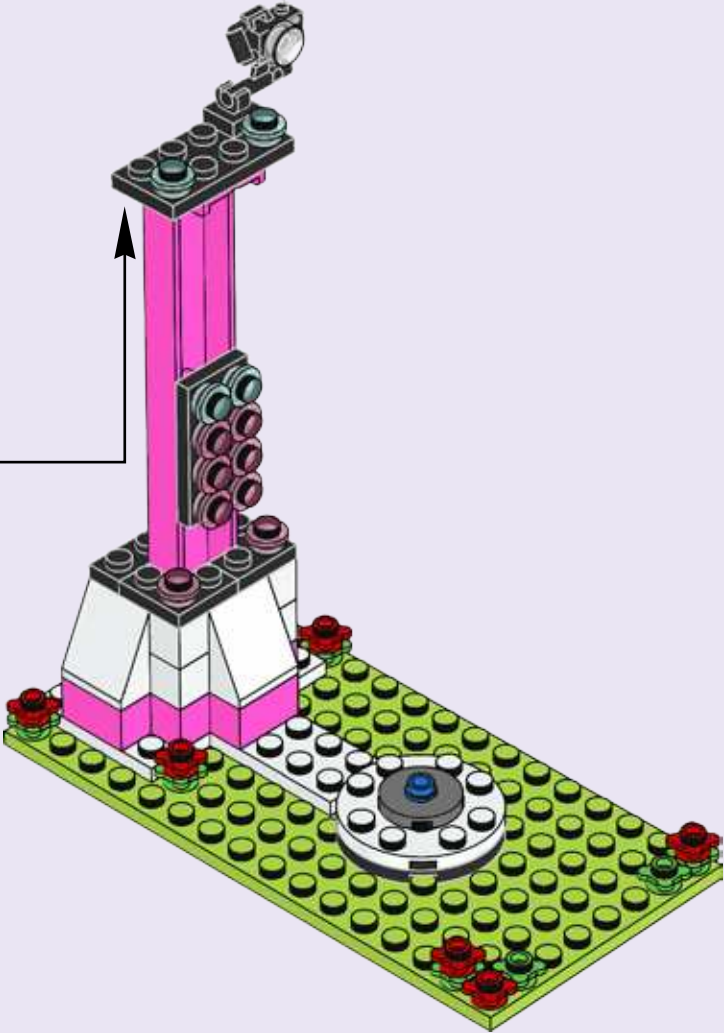
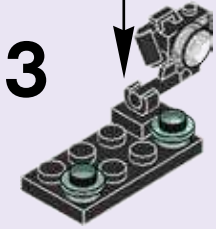
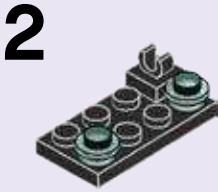
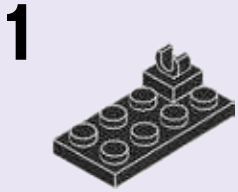
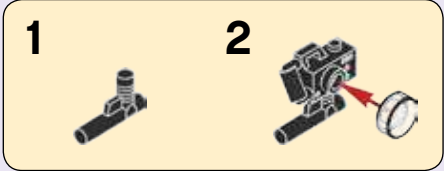

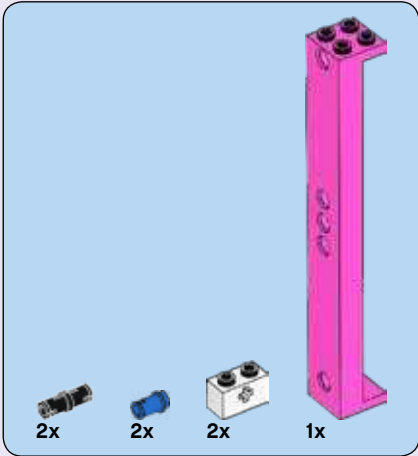

15

1

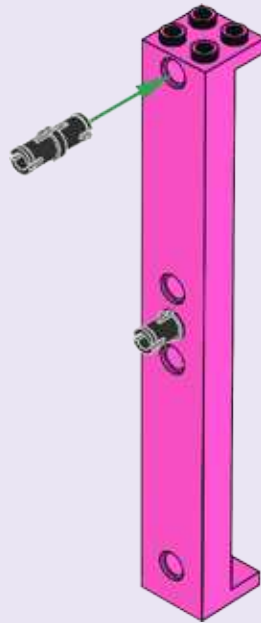

2

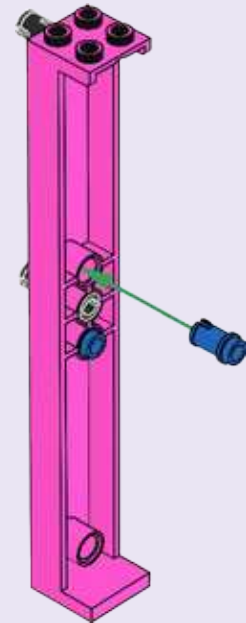

3

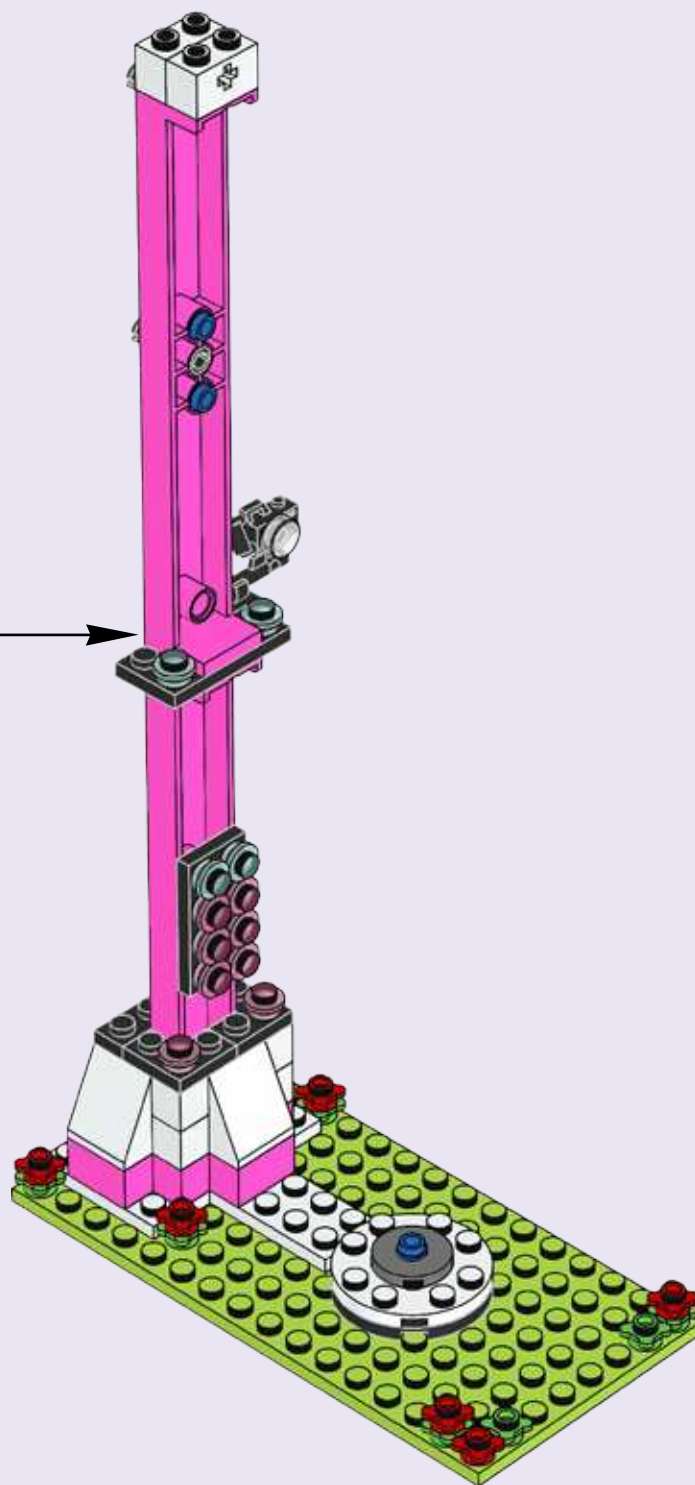
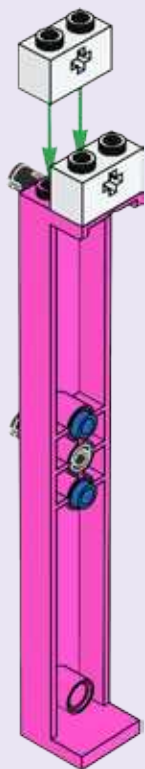

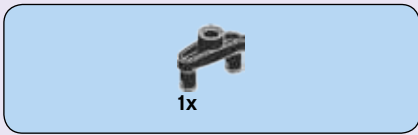

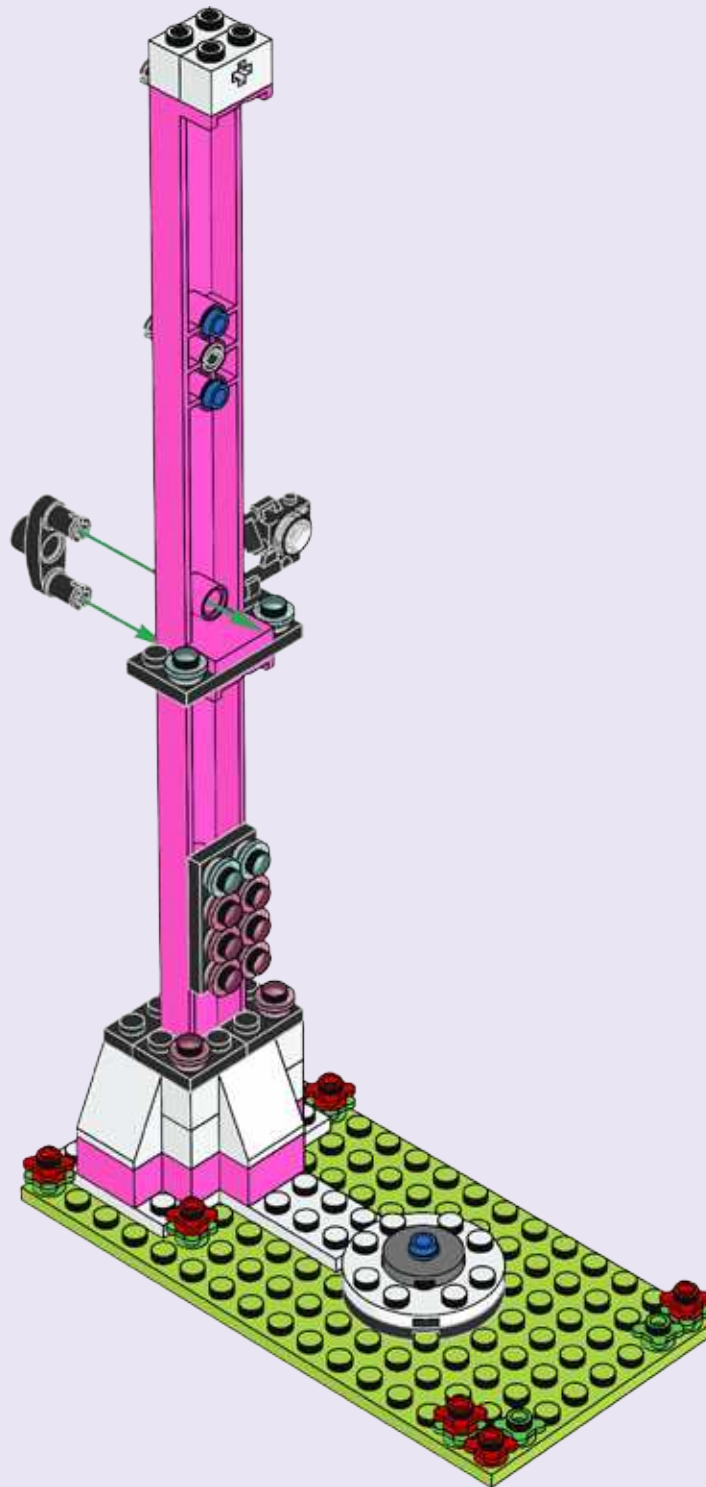

16

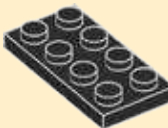

1x  6x  2x 

17

1  2 

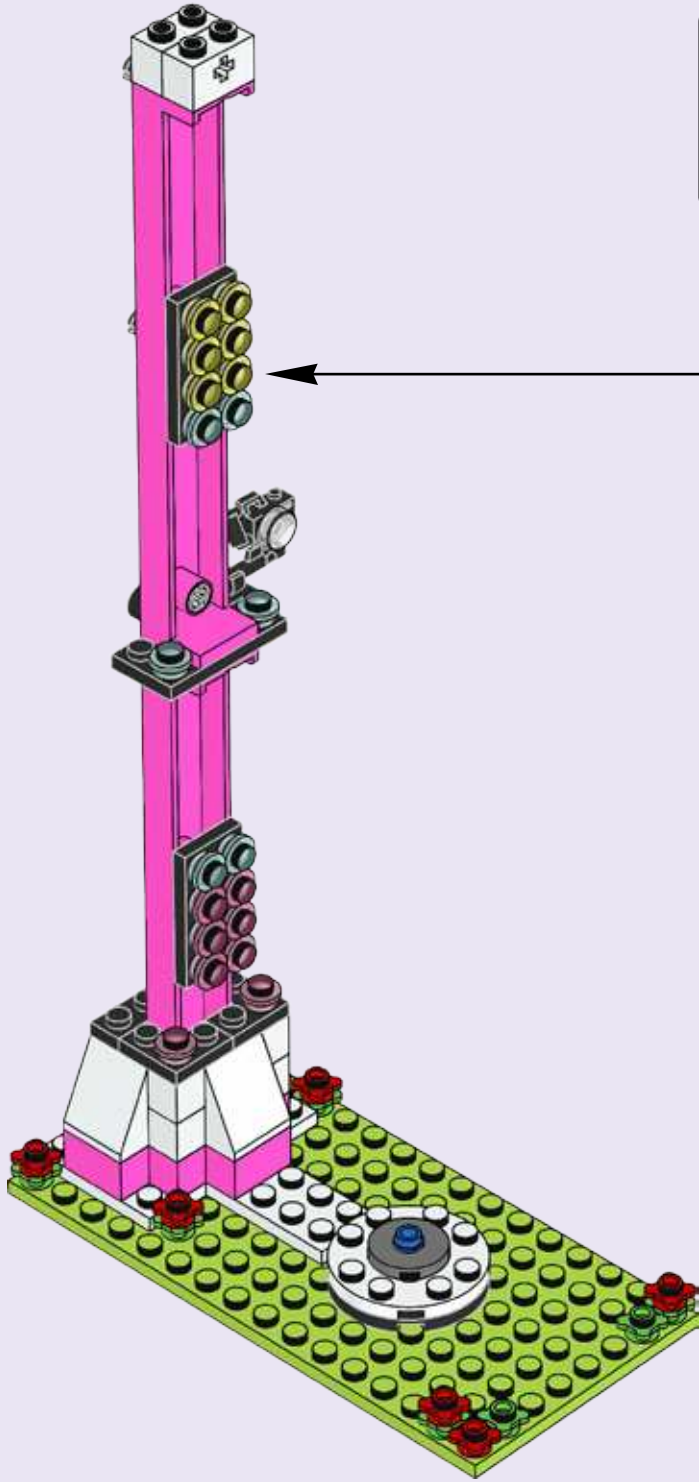

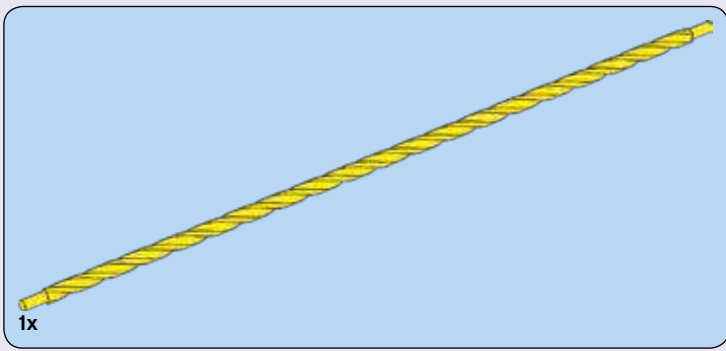

18

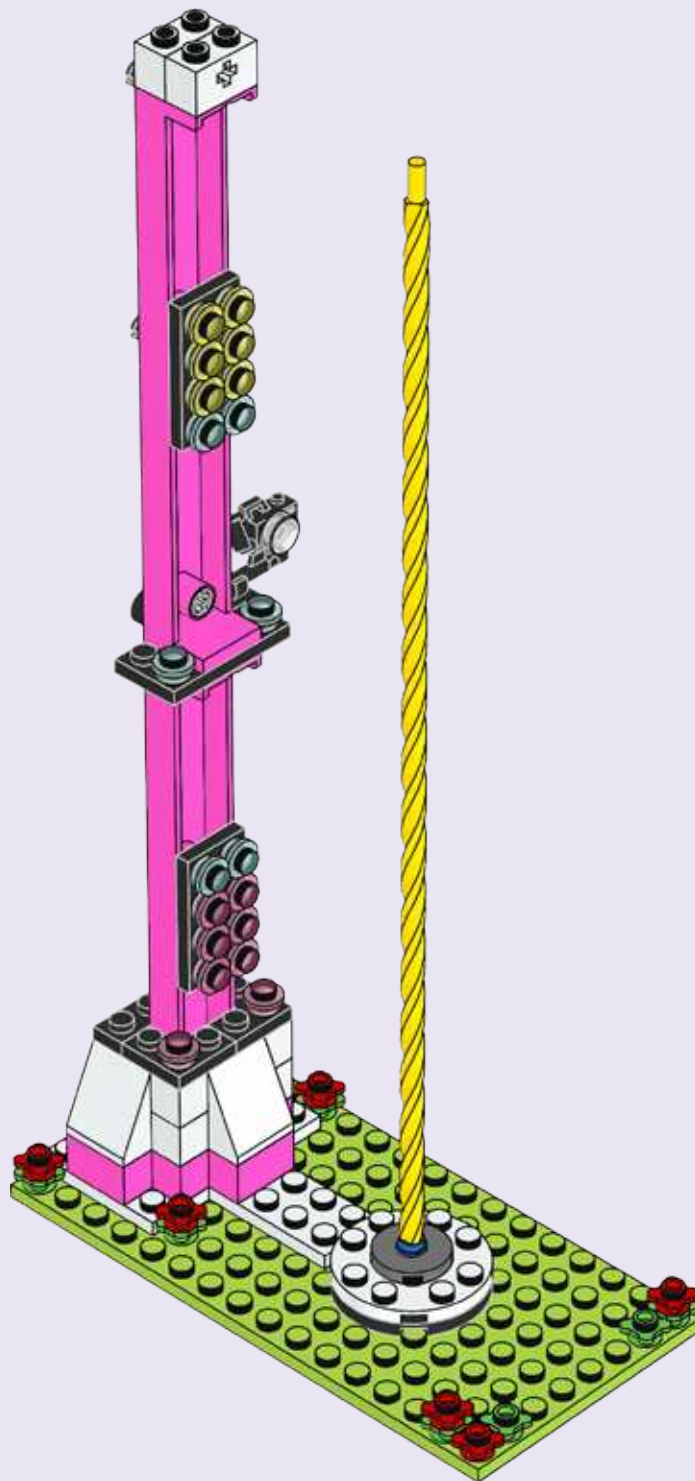

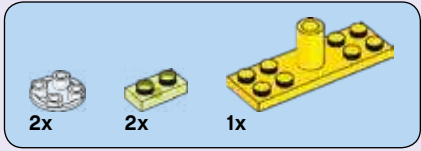
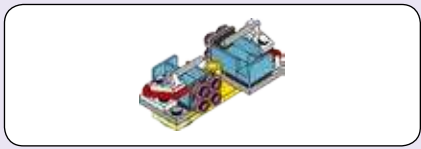

19

1

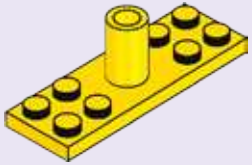

2

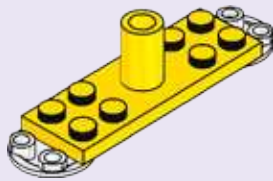

3

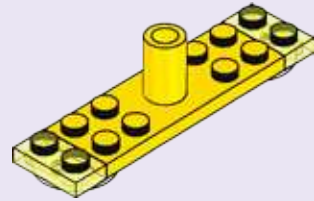

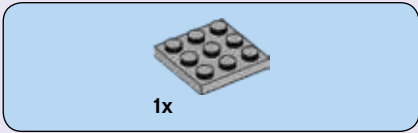

20

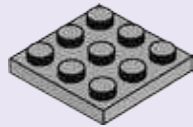

21



22

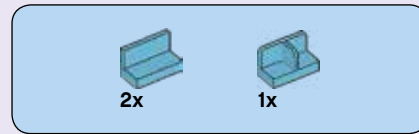
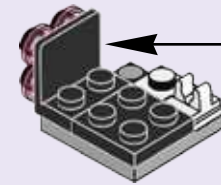
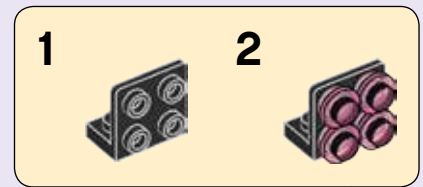

23

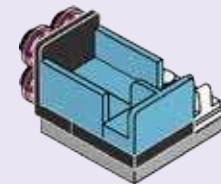

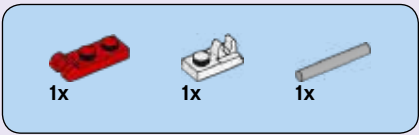

24

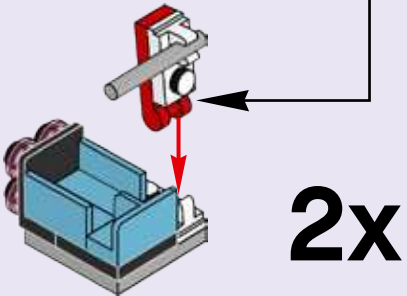
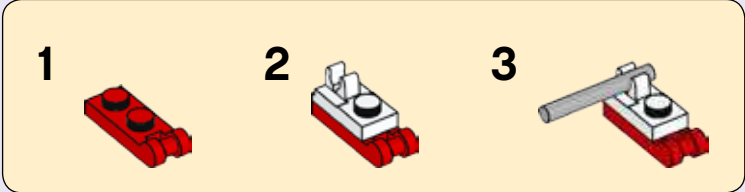

25

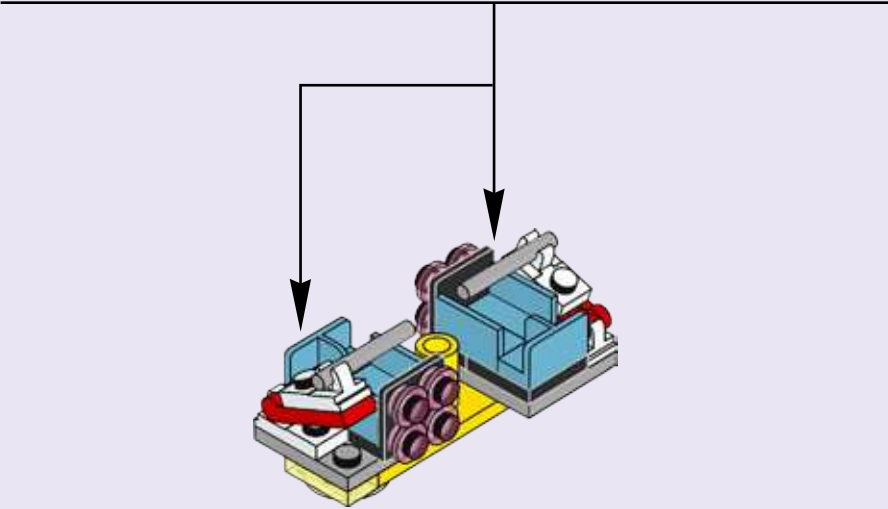
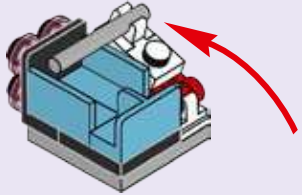

26

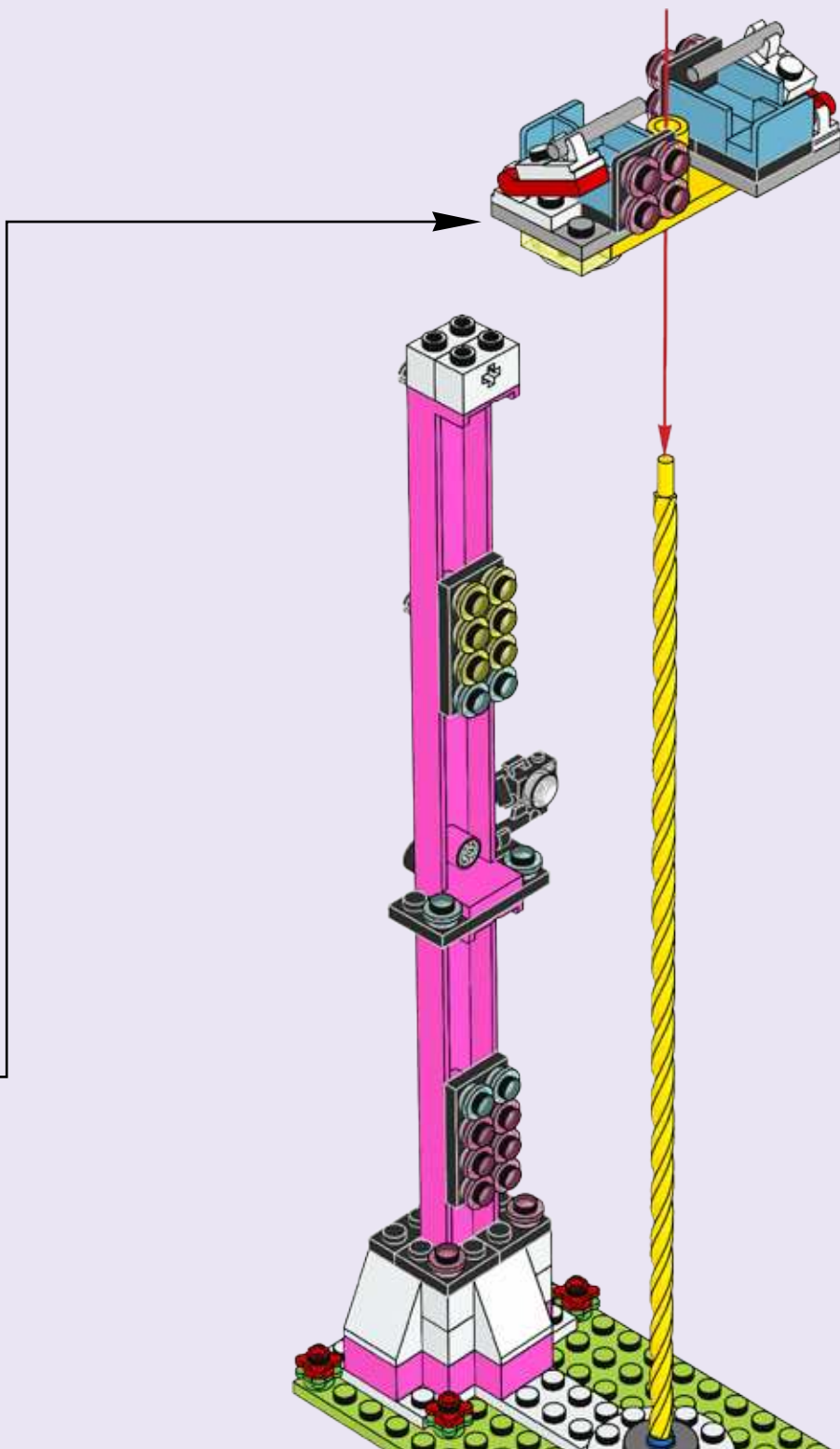

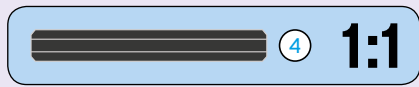
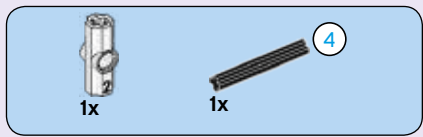

27

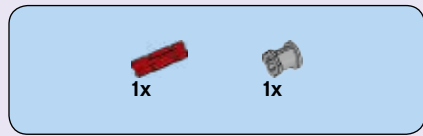
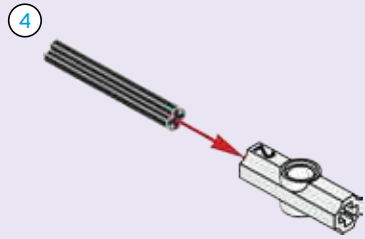

28

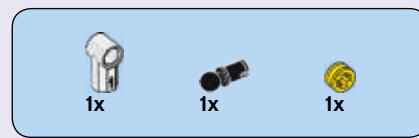
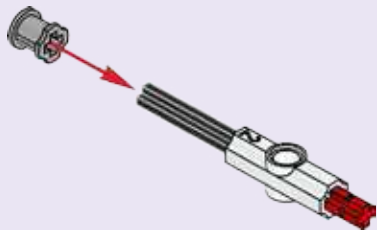

29

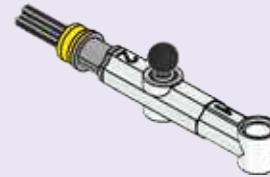

30

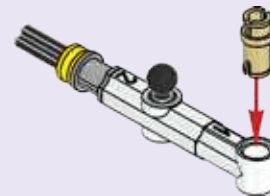

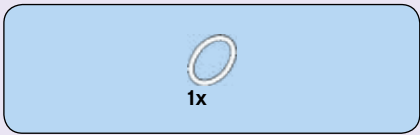

31

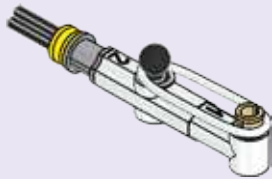

32

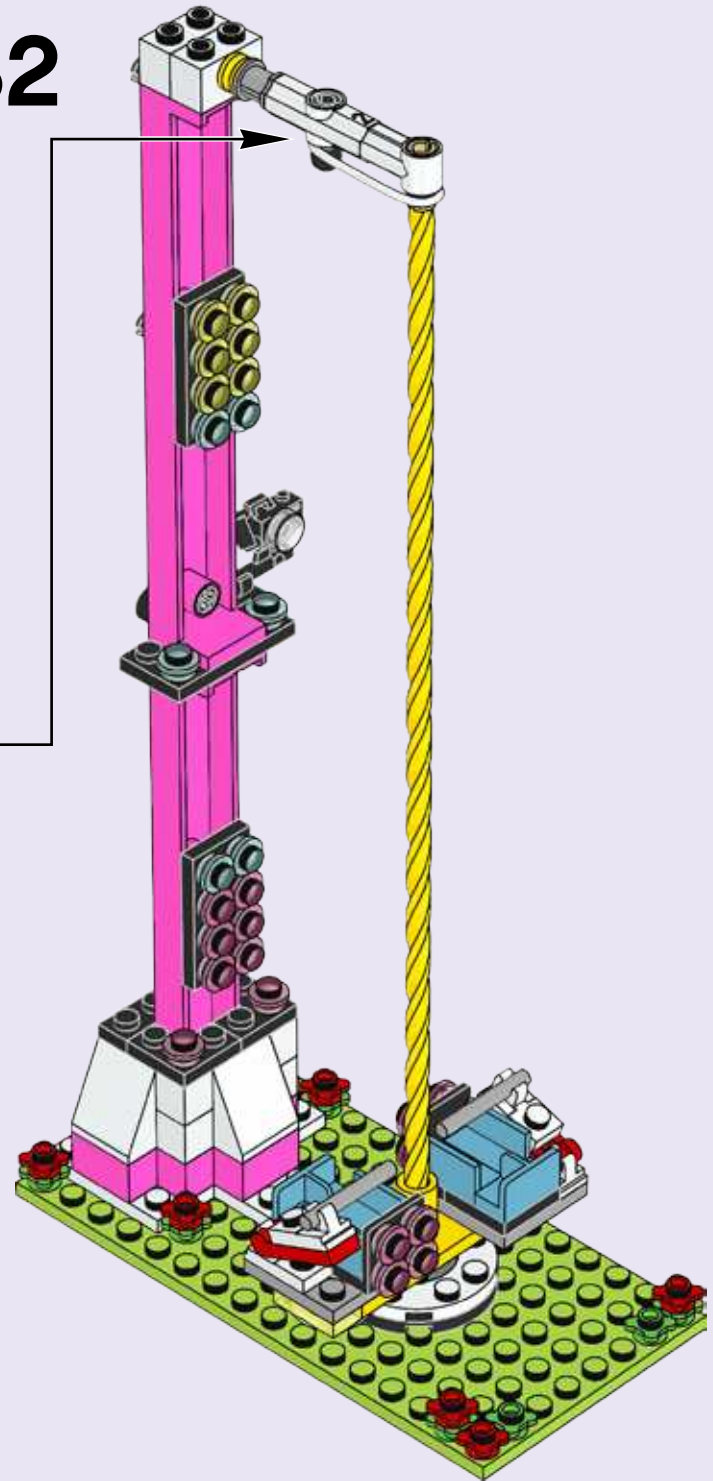

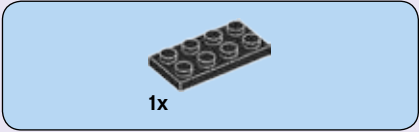
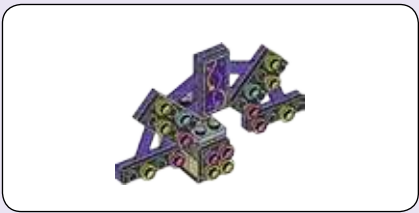

33

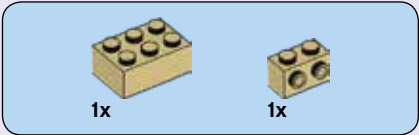
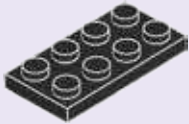

34

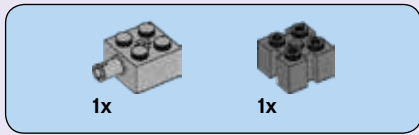
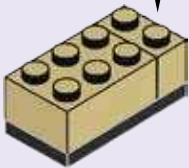
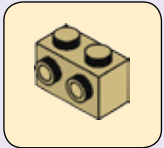

35

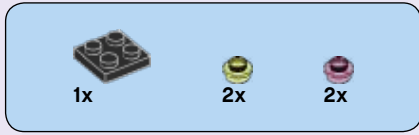

36

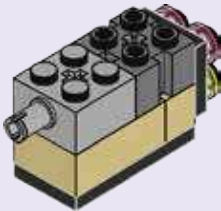
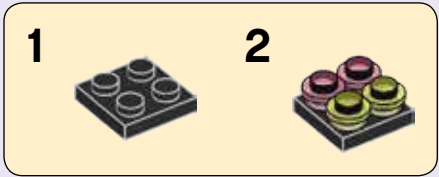

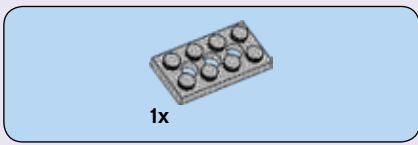

37

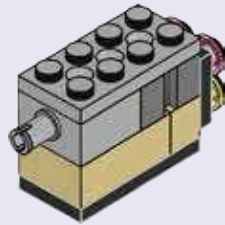

38

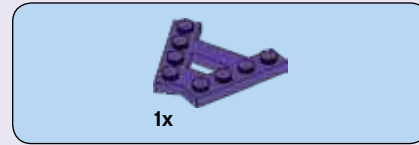
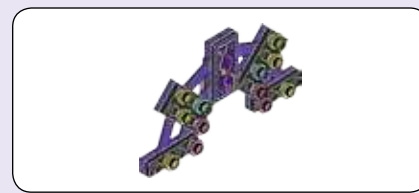
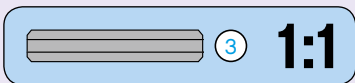
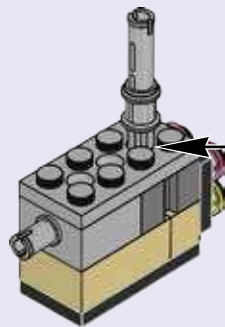
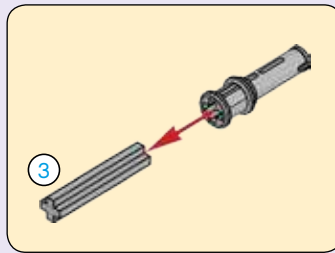

39

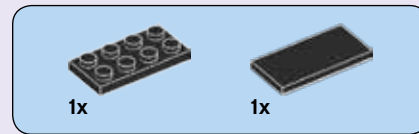
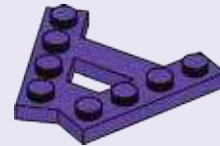

40



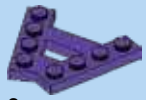

2x

41

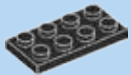

1x

42



1x

43



2x

44

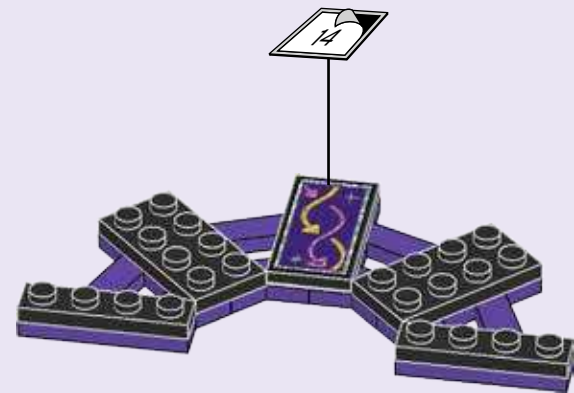

6x 2x 4x

45



1x

46

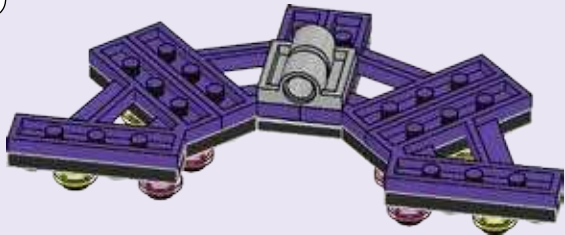

47

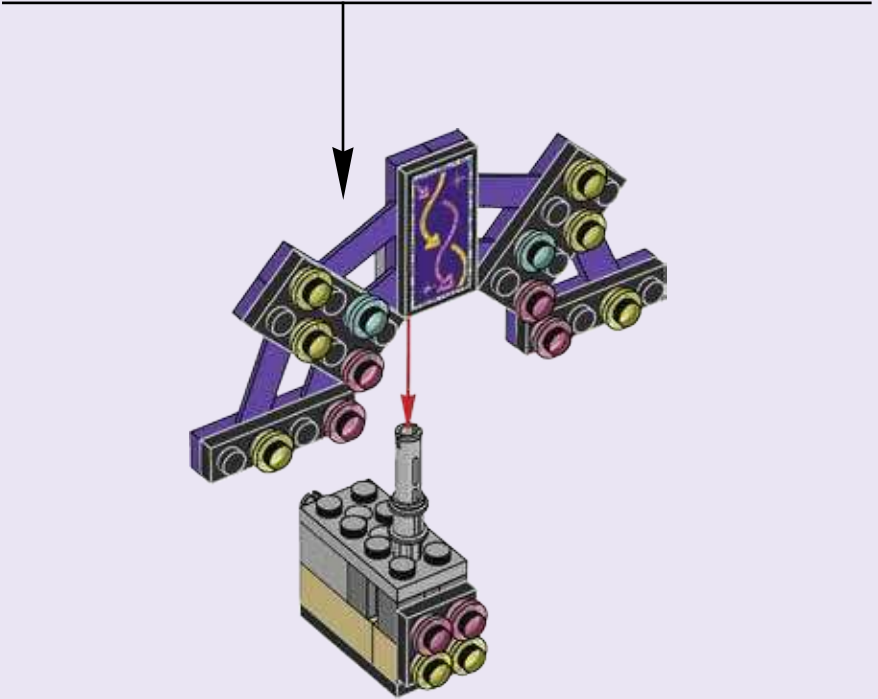

48

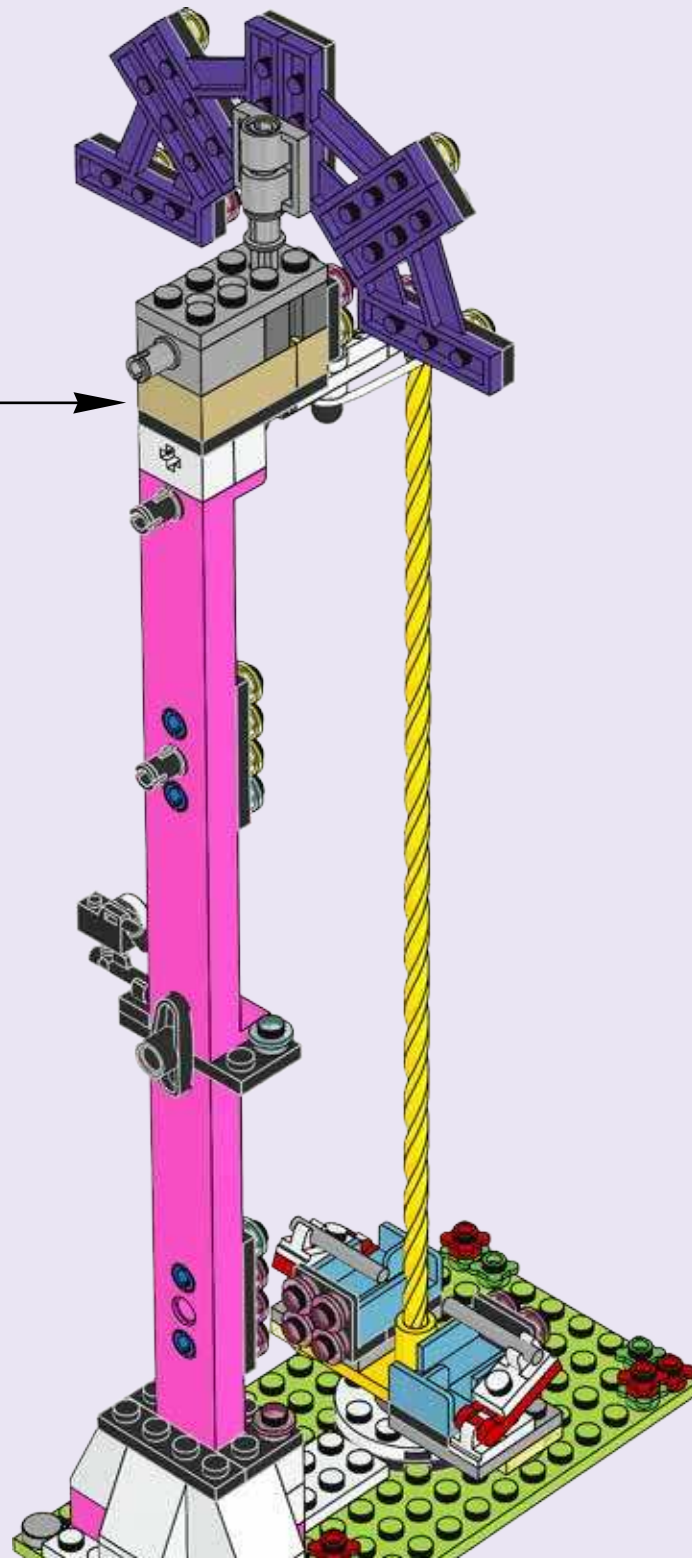

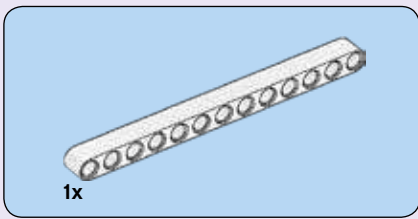

49

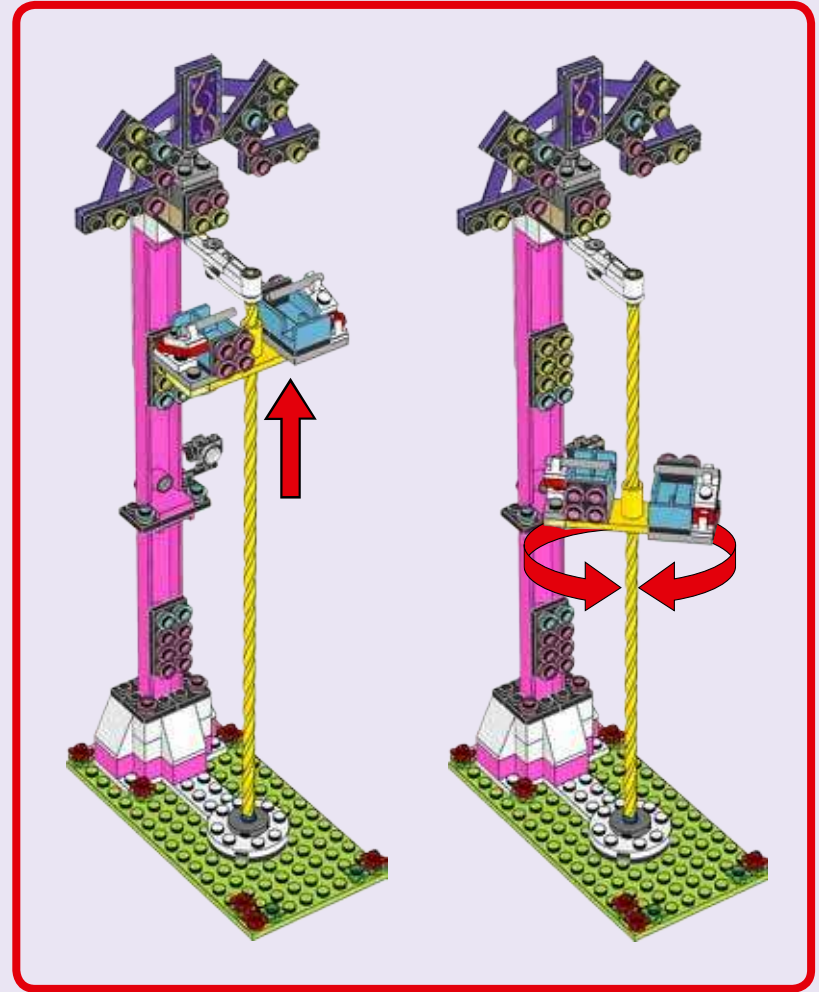
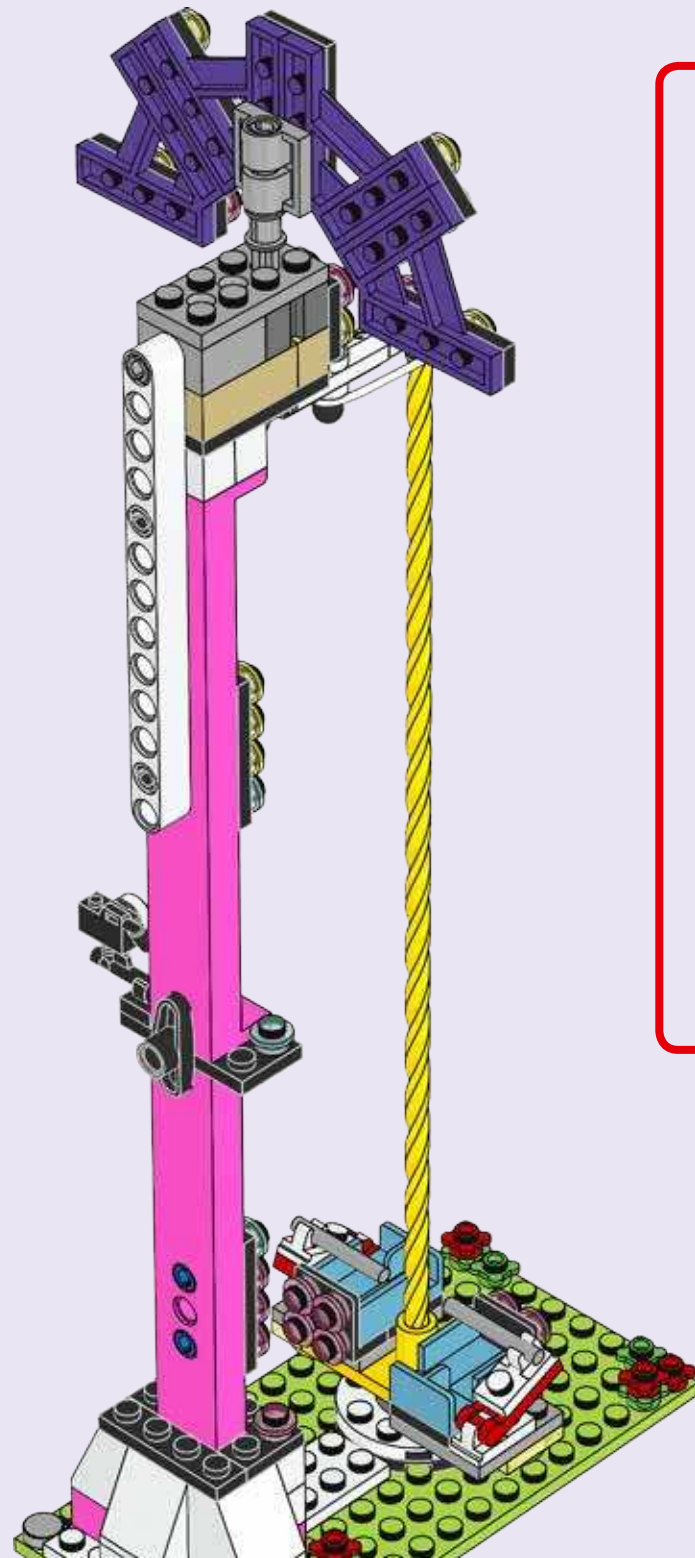

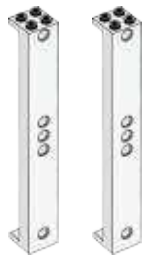
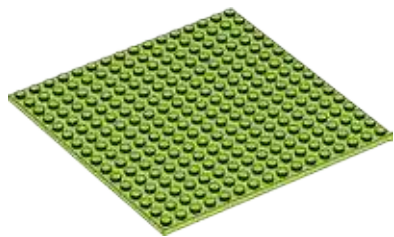

+

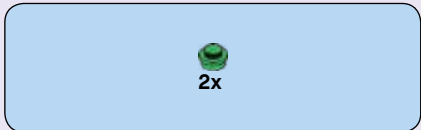
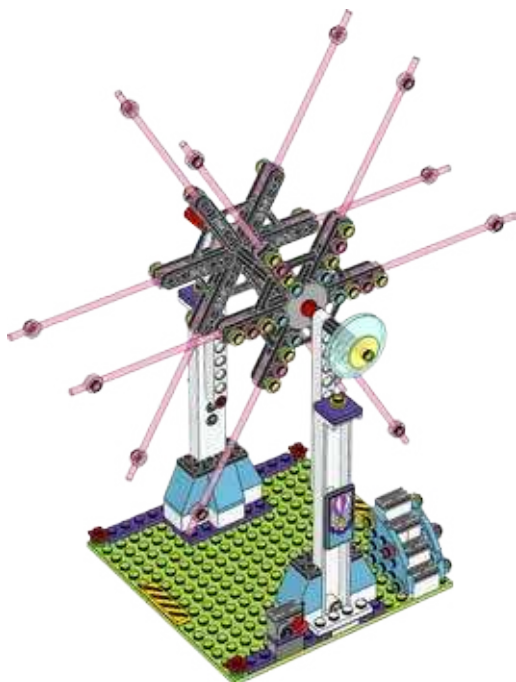

1

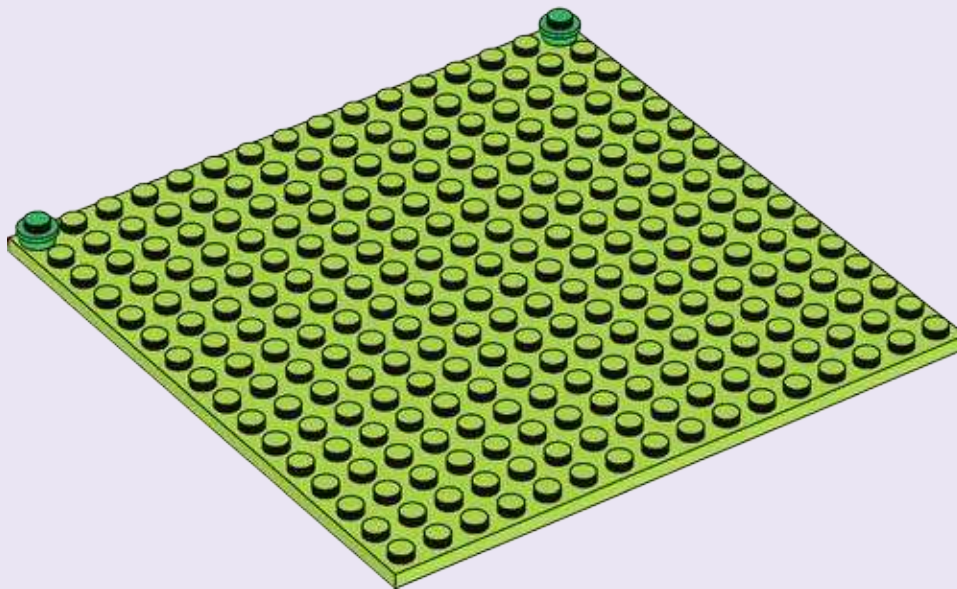

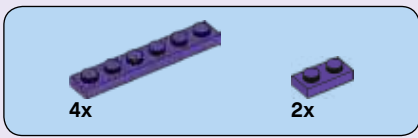

2

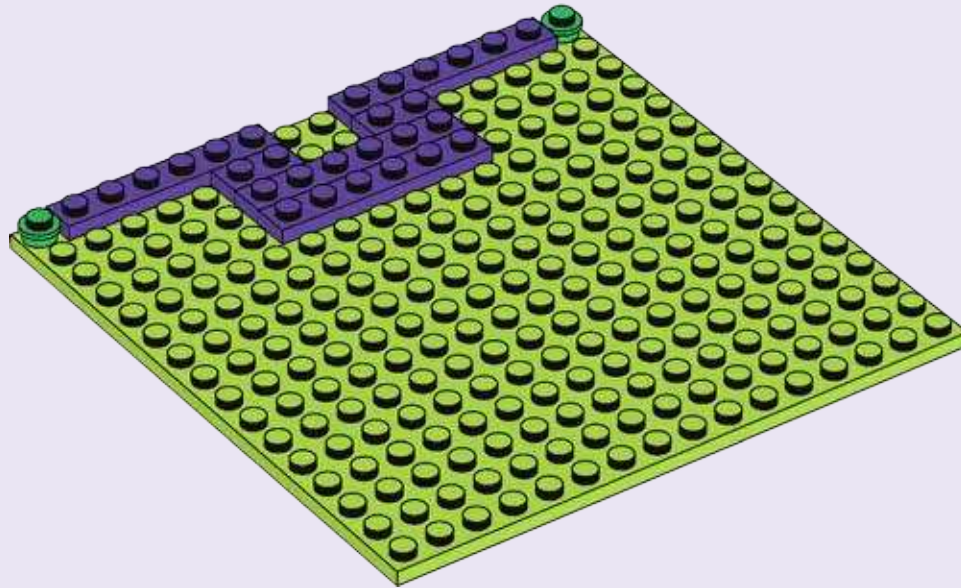

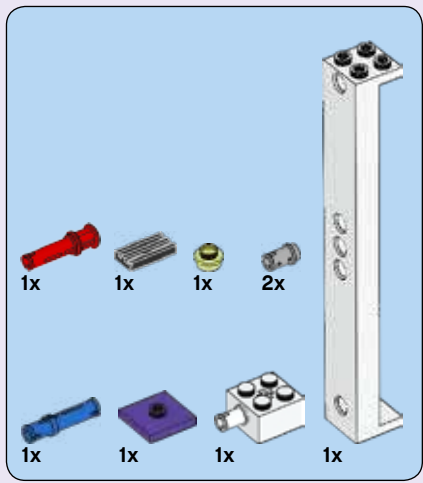

3

1

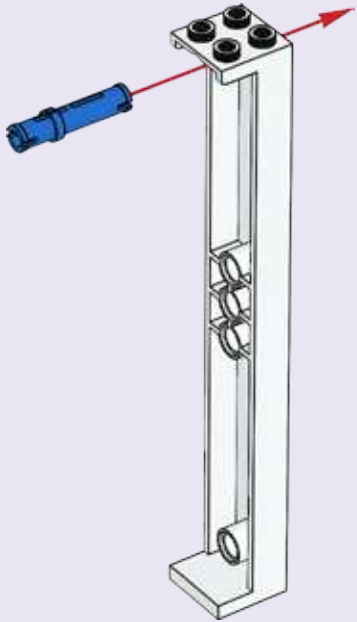

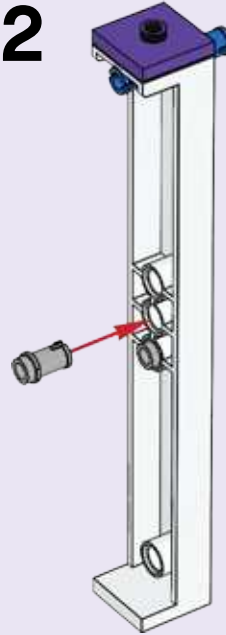

2

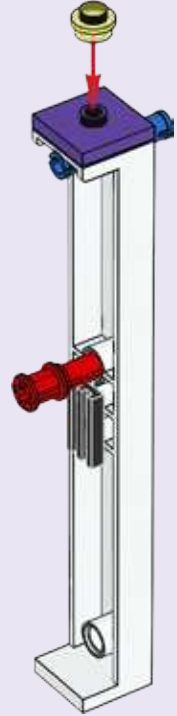

3

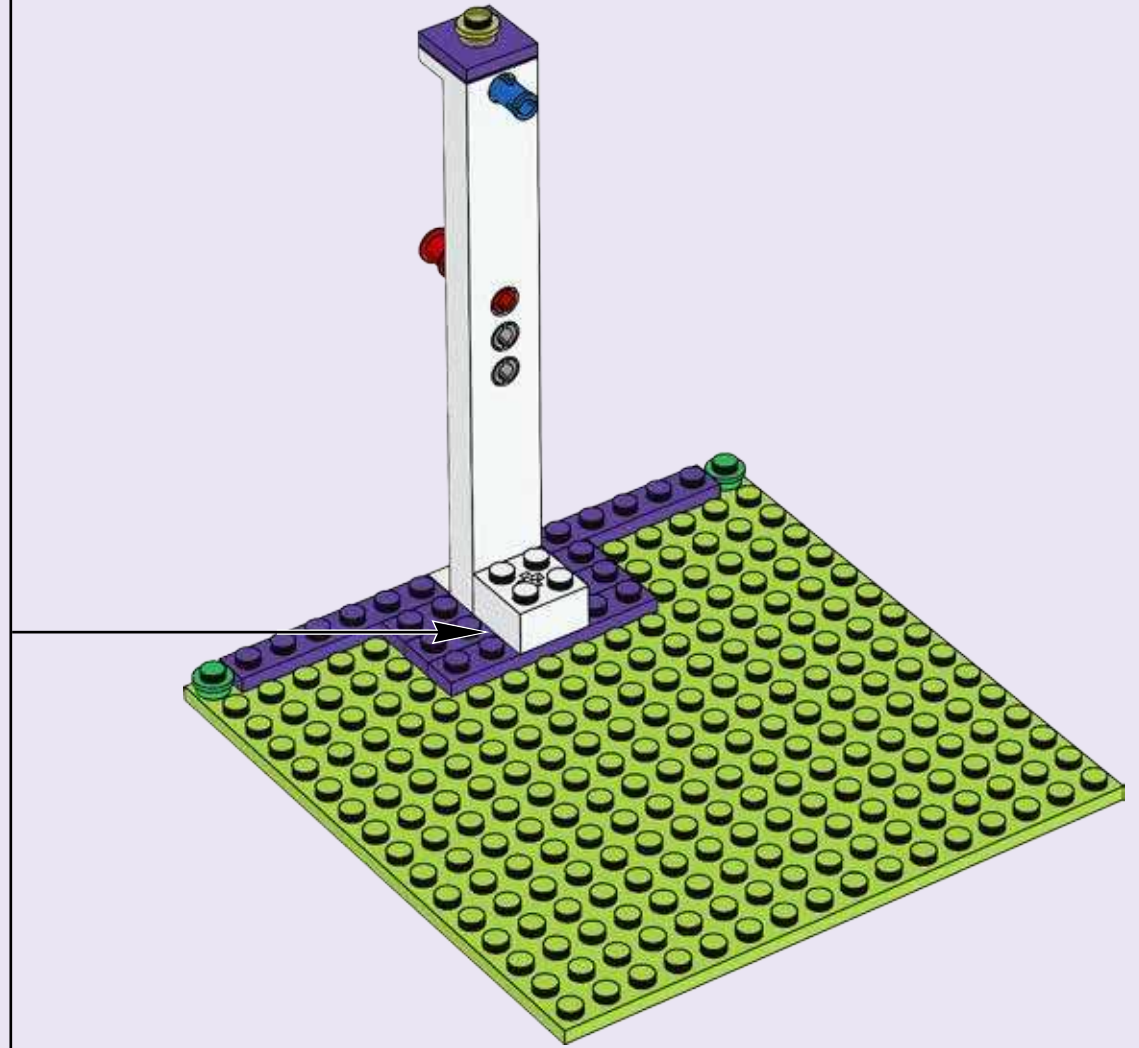
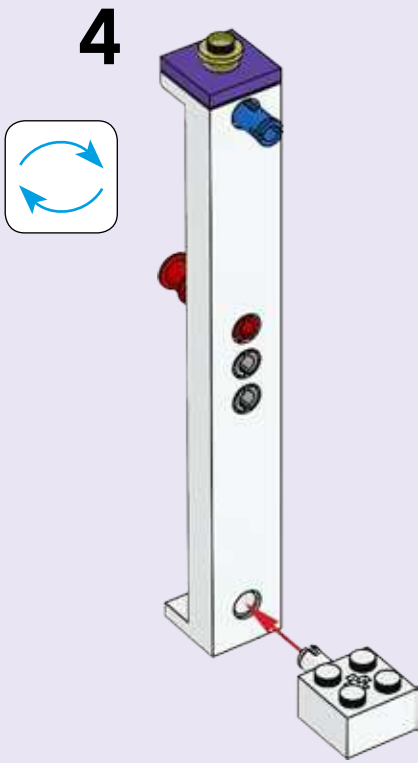



1x  2x 

4

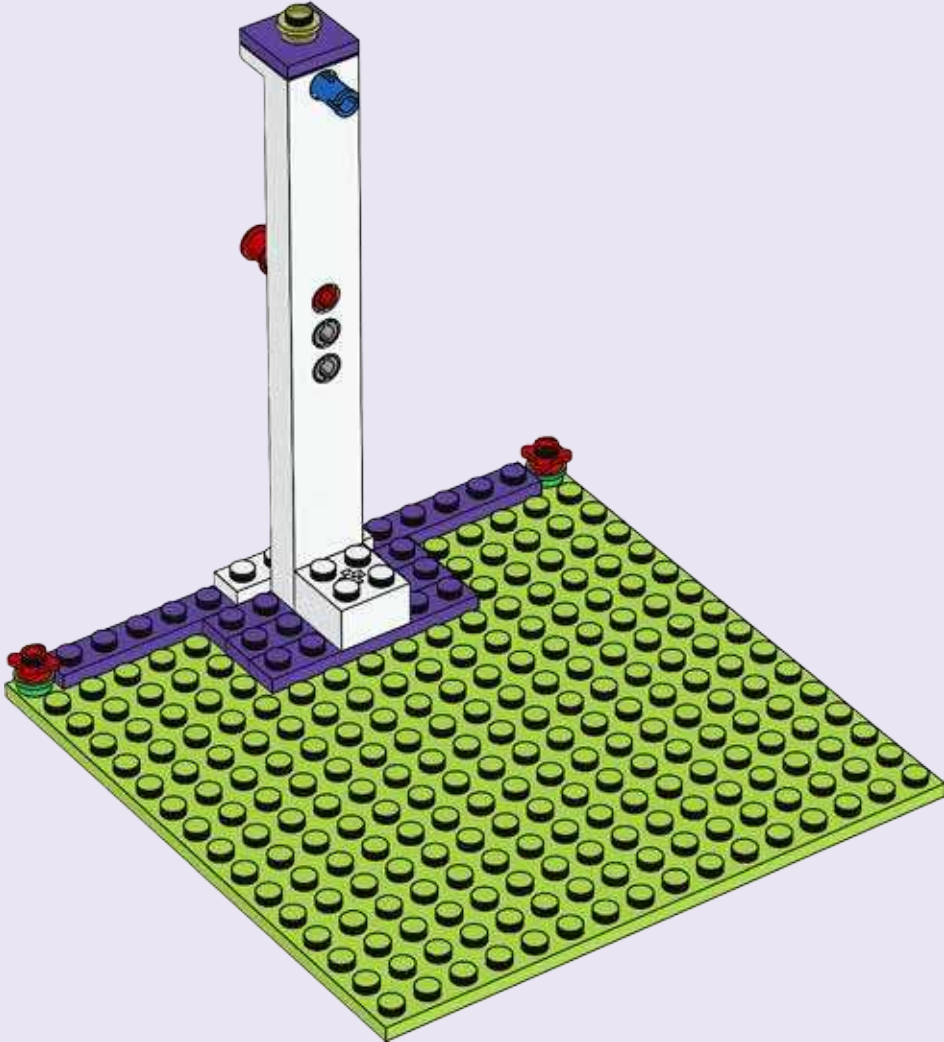

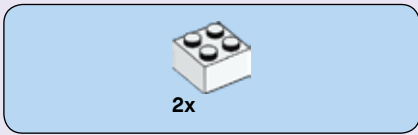

5

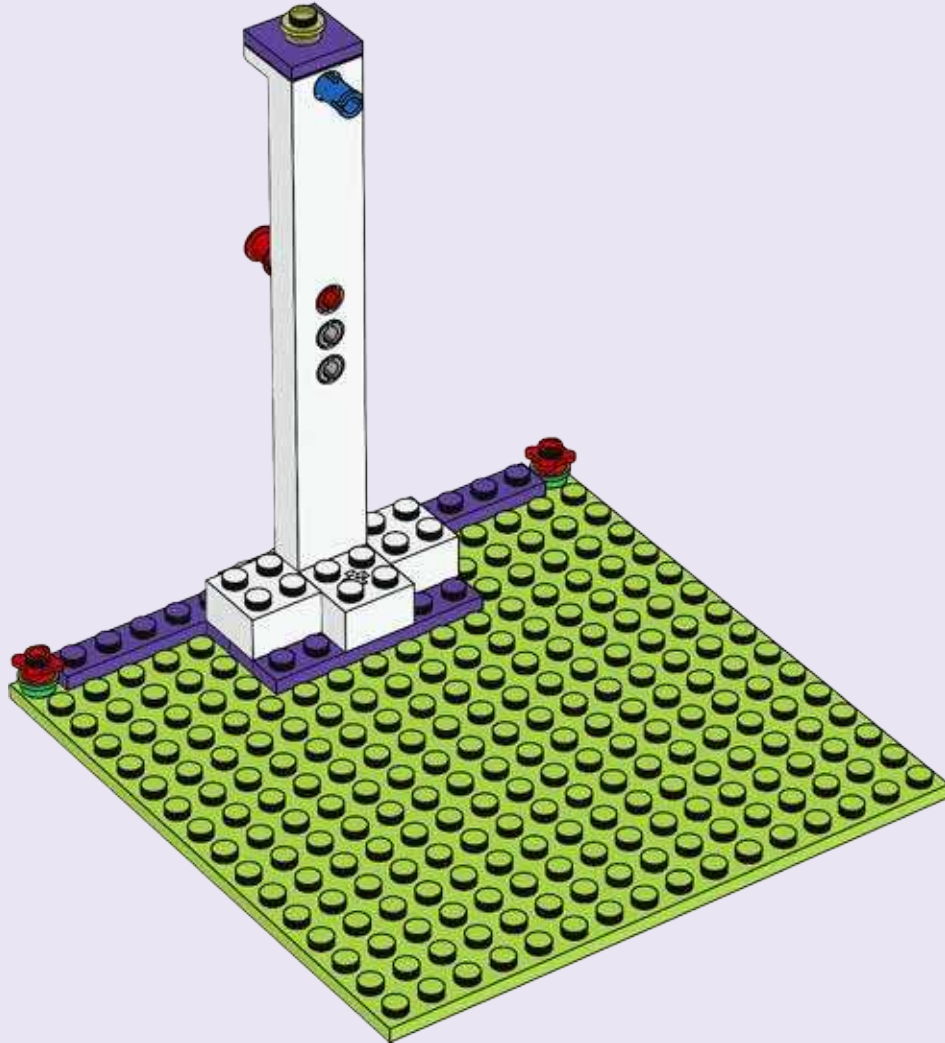

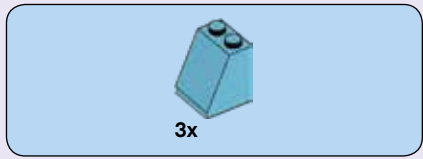

6

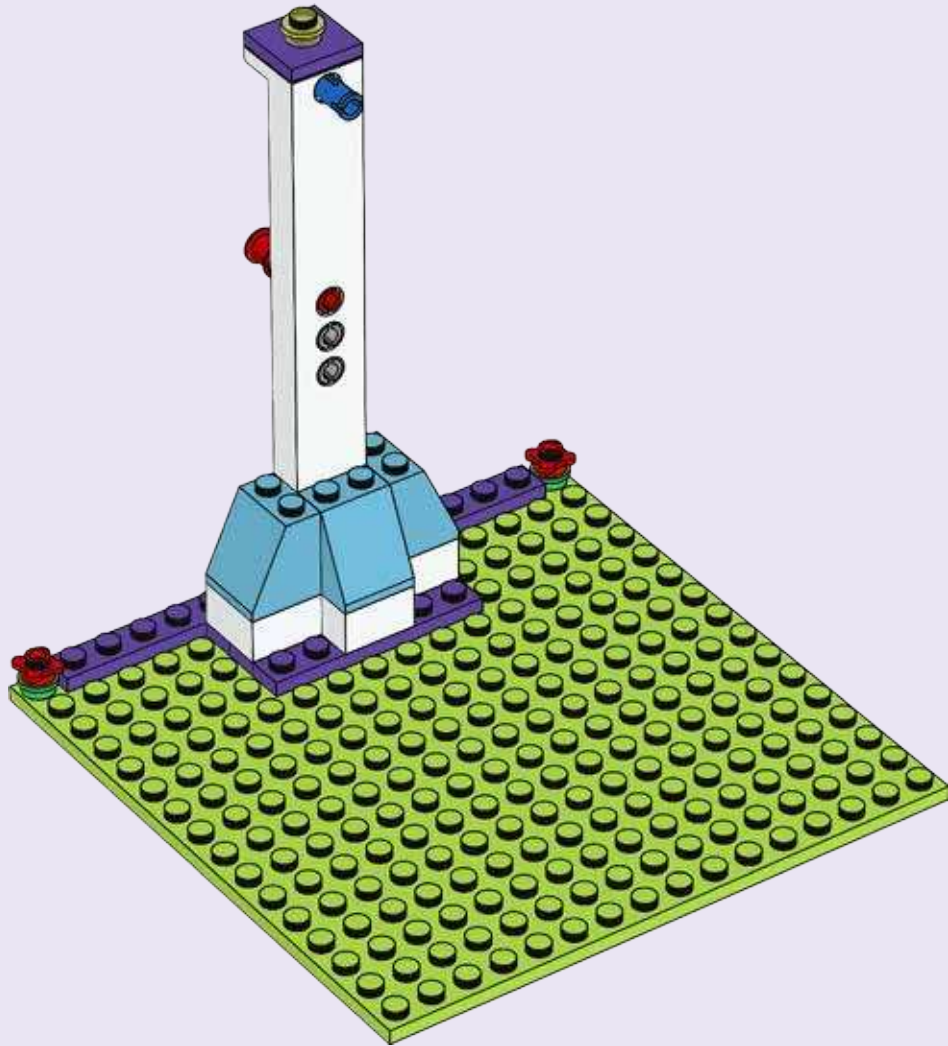



7

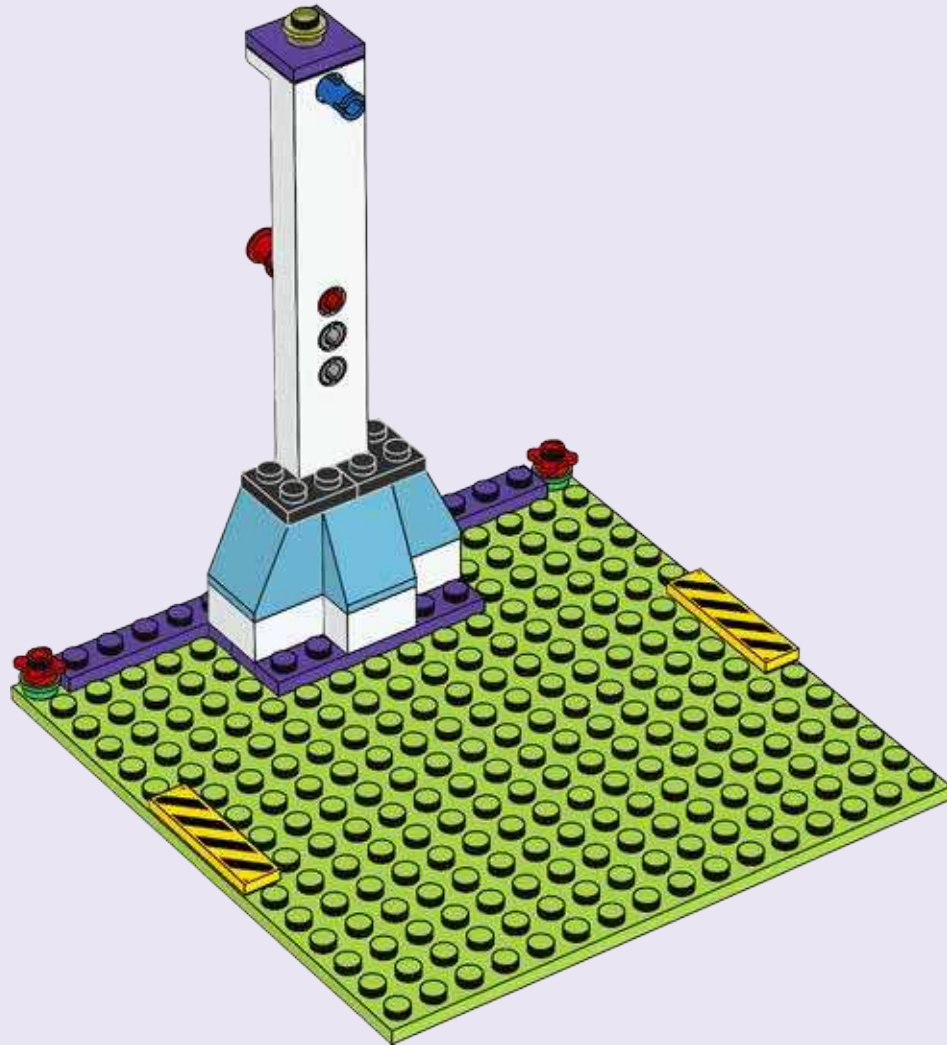

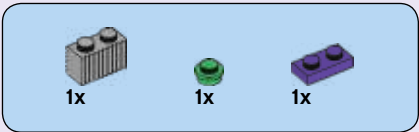

8

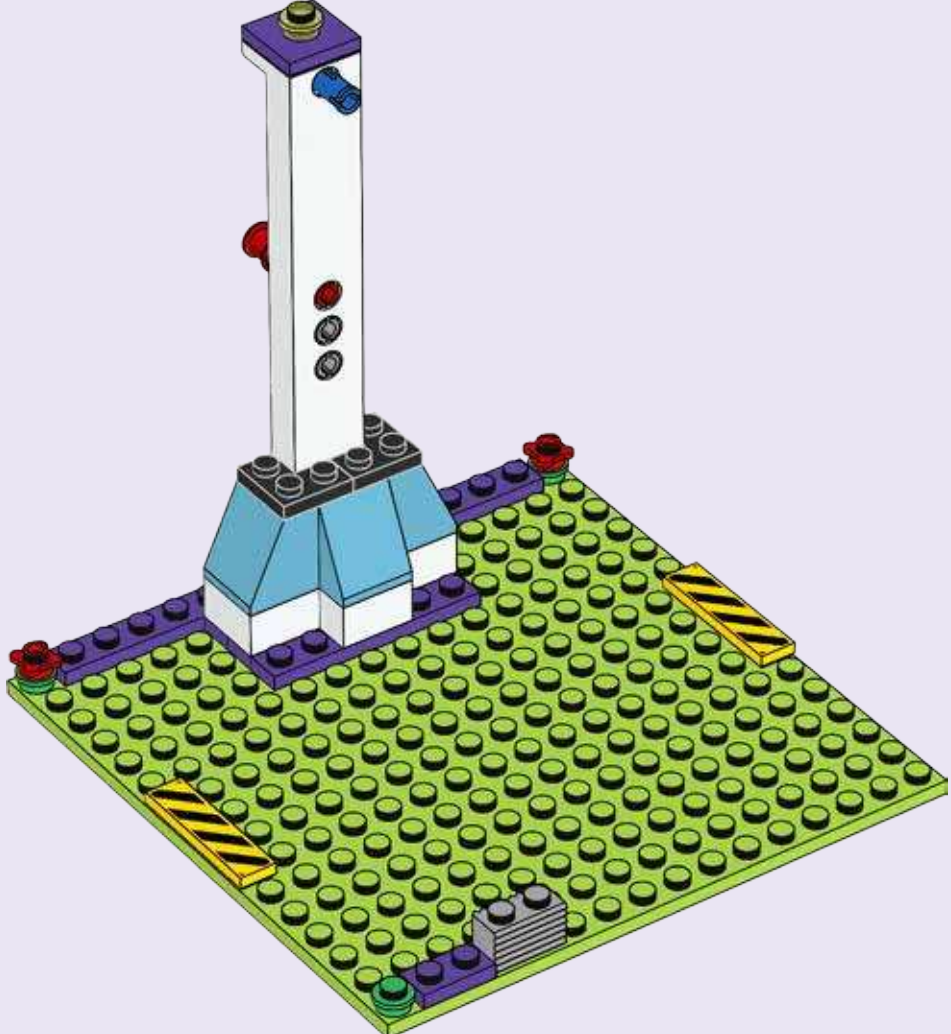

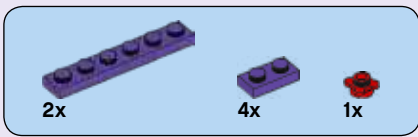

9

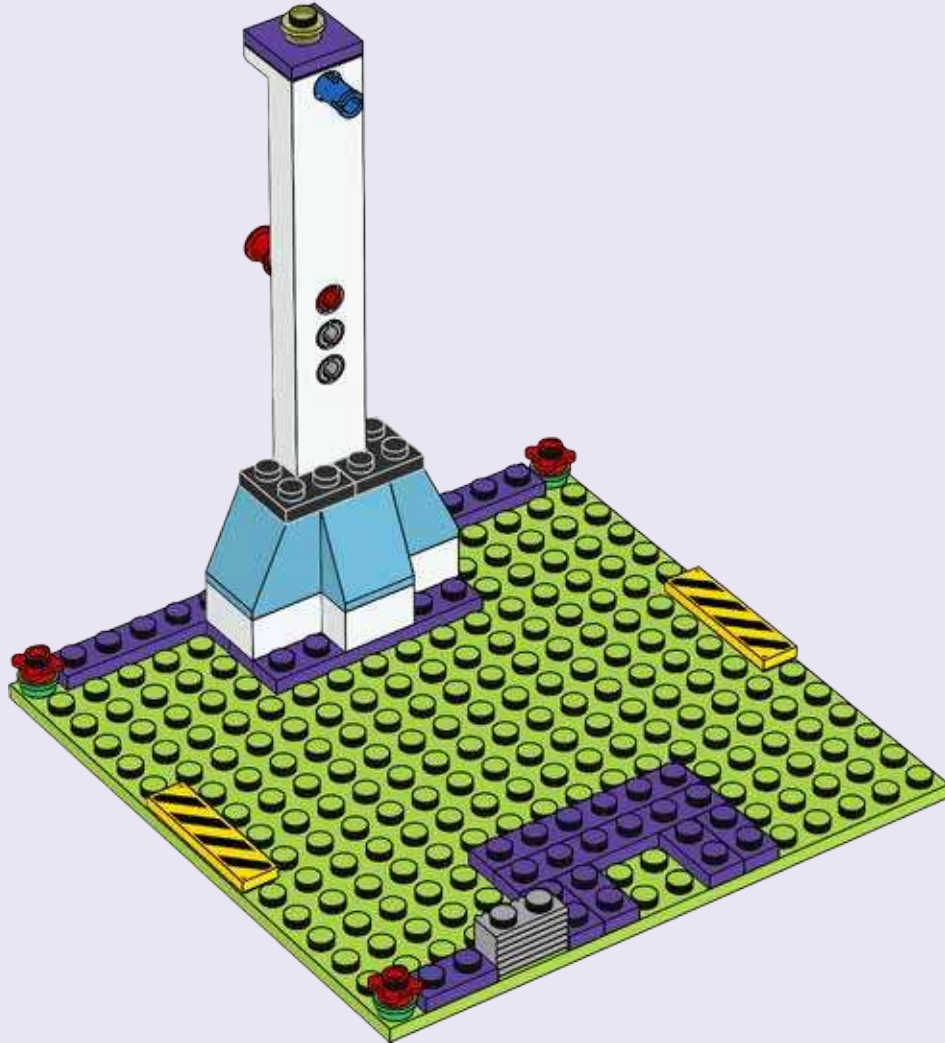

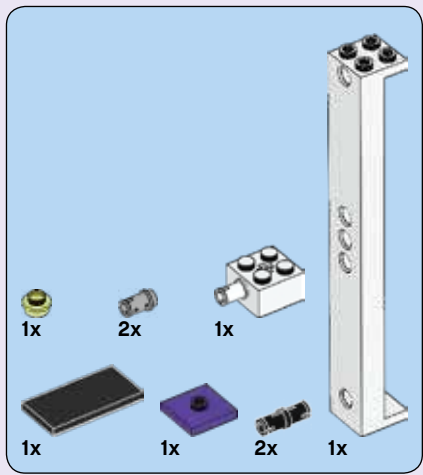

10

1

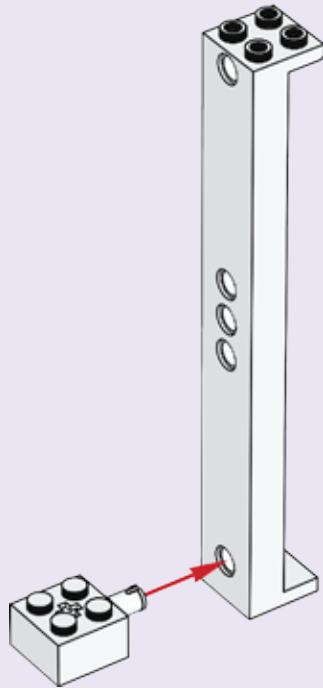

2



3

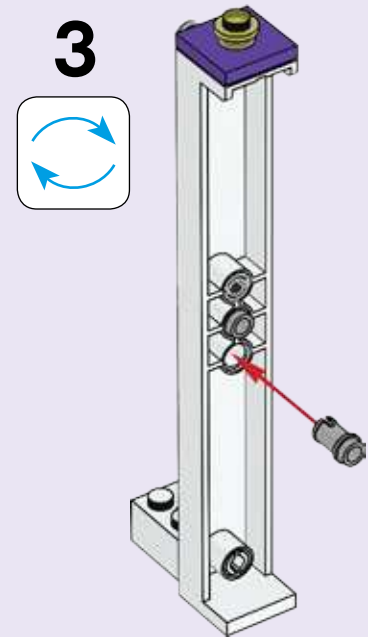

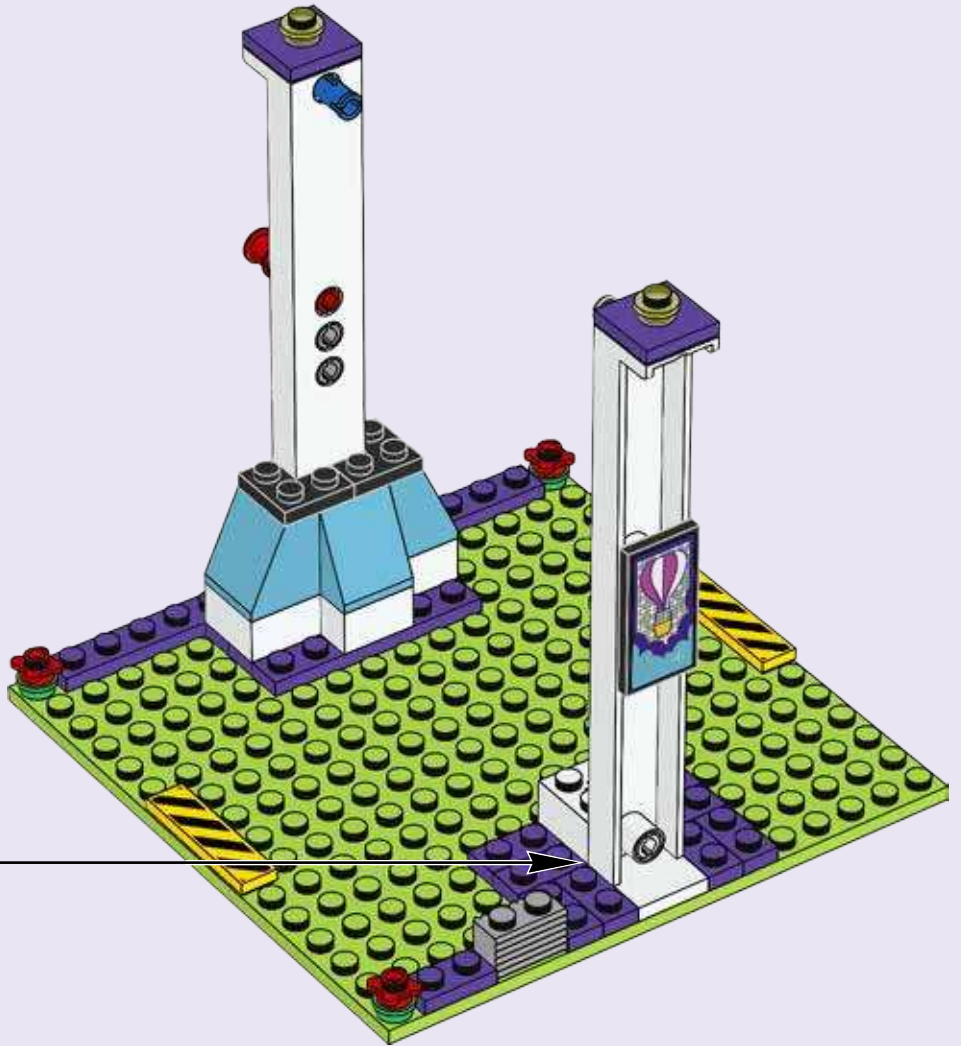
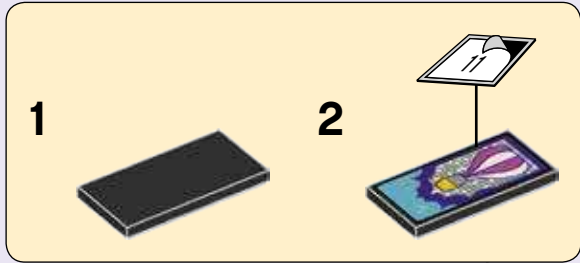

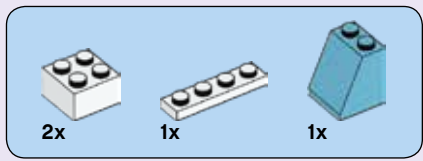

11

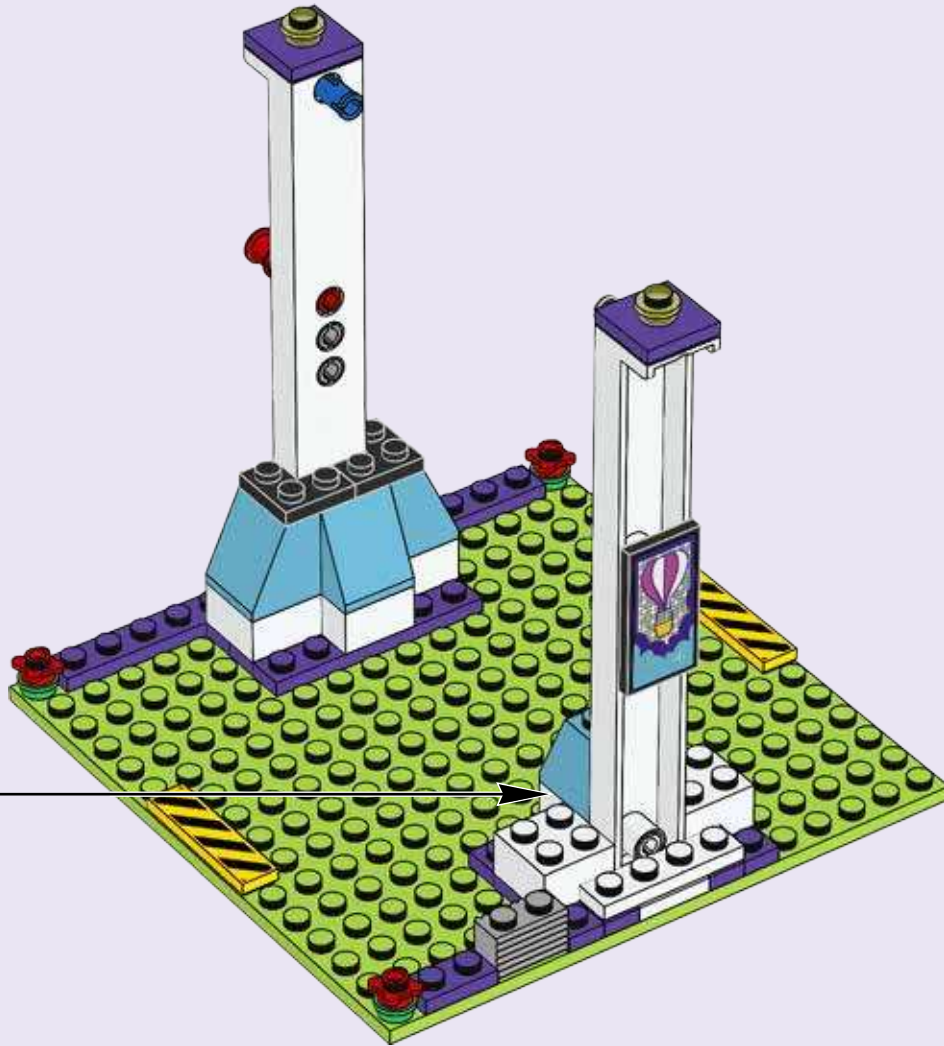
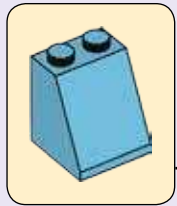



12

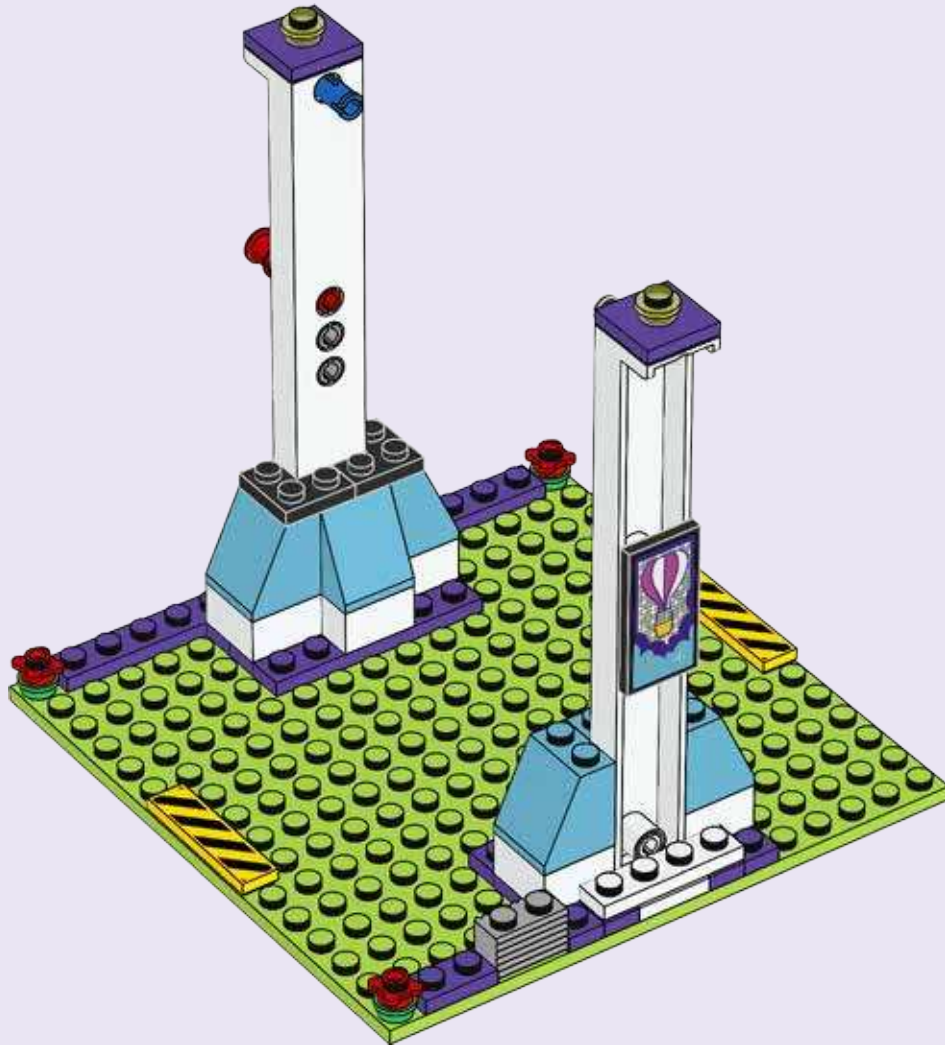



2x

13

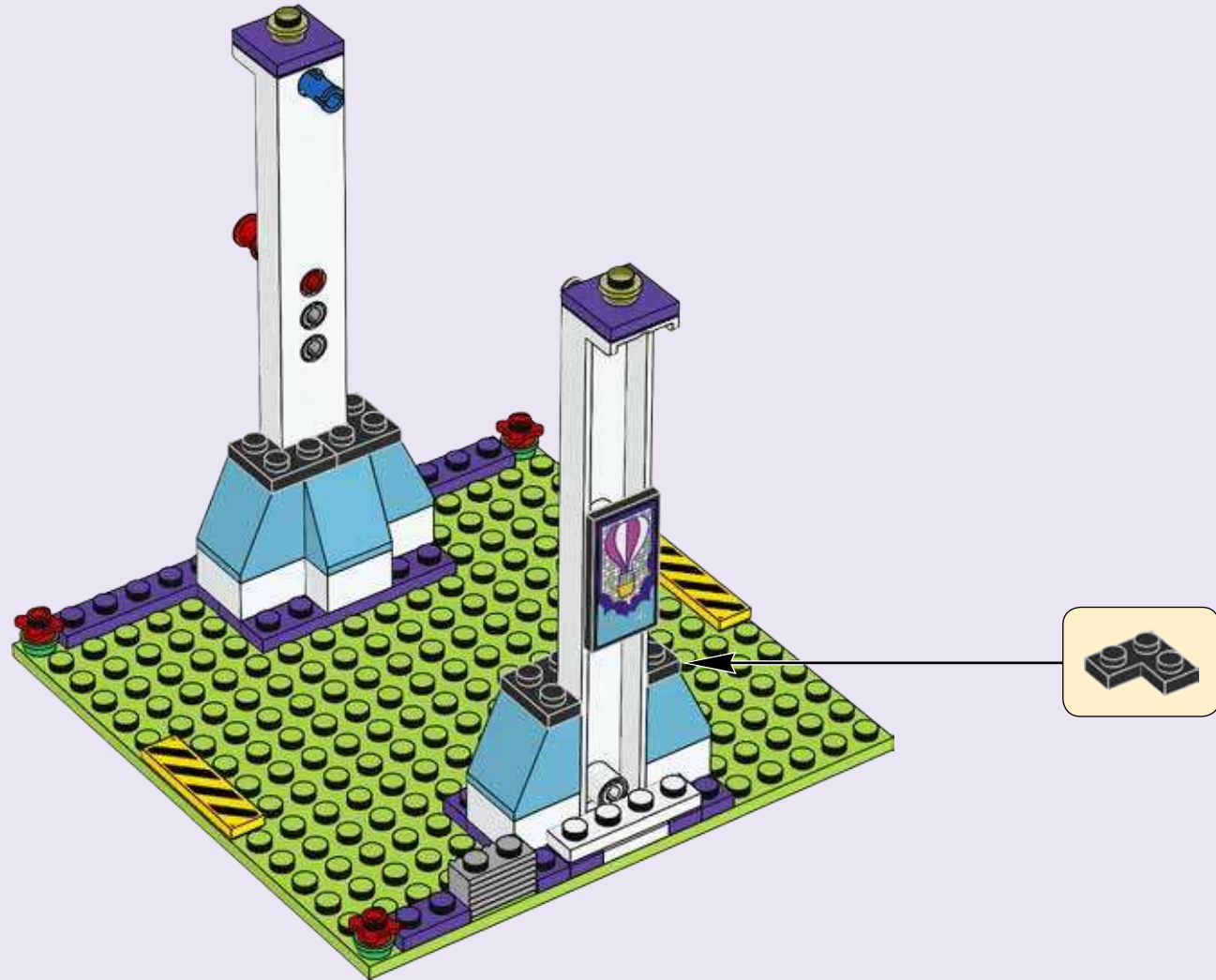

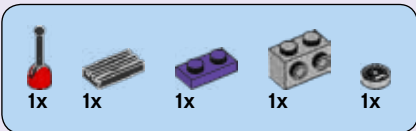

14

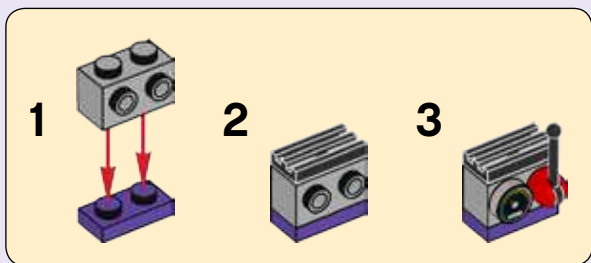
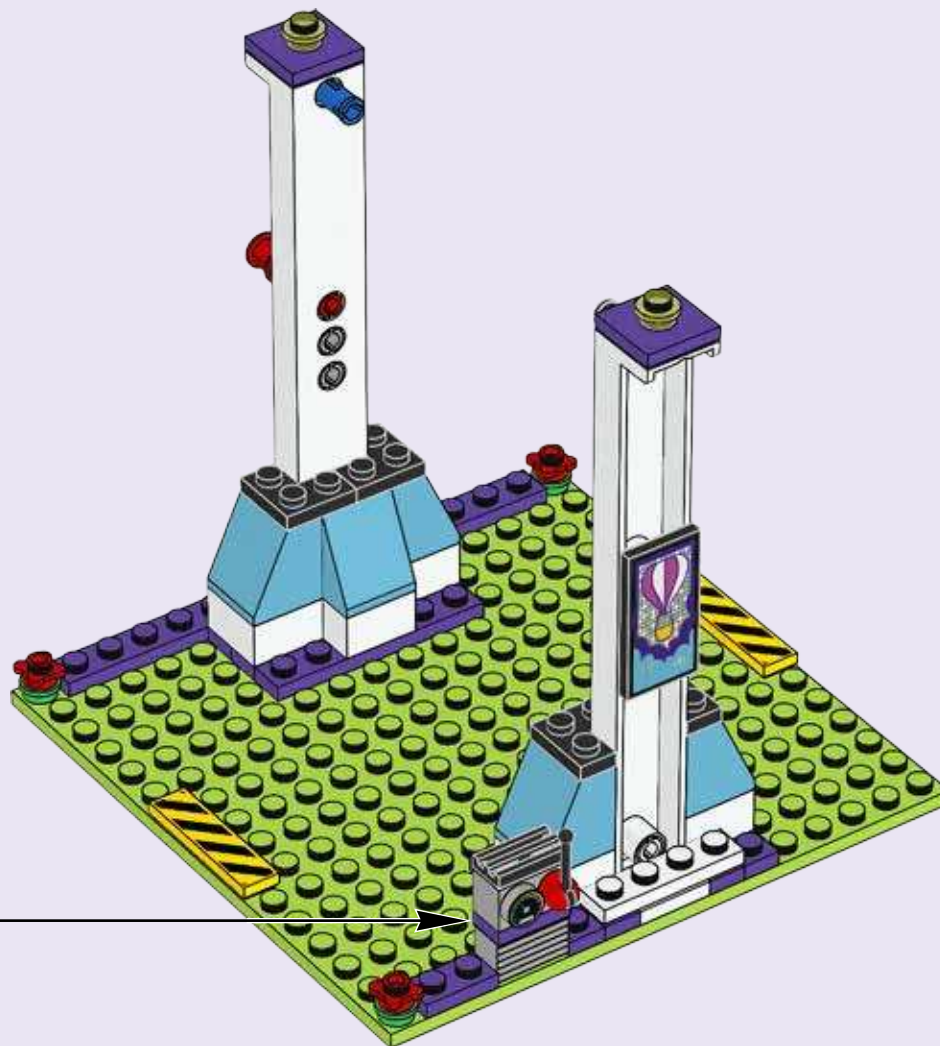

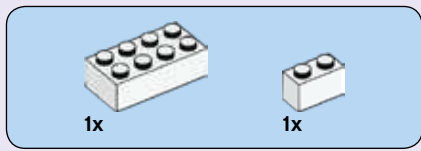

15

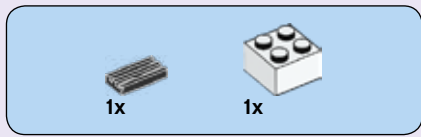
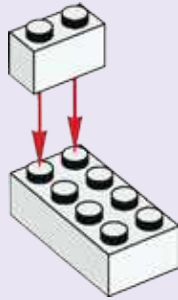

16

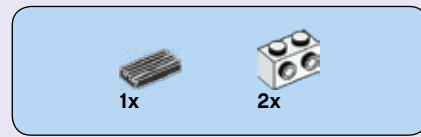
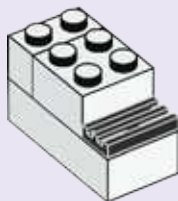

17

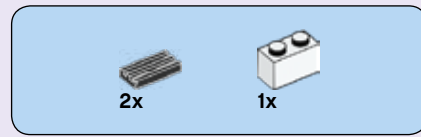
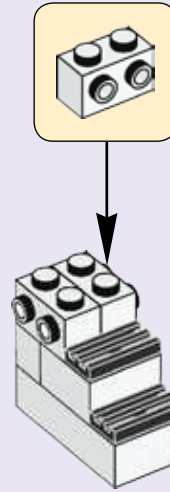

18

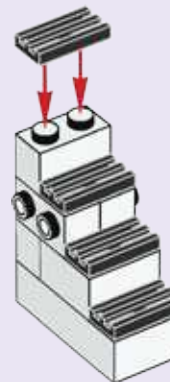

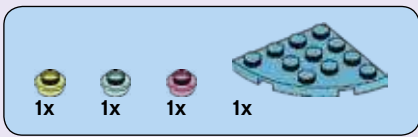

19

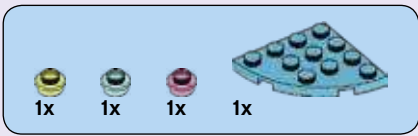
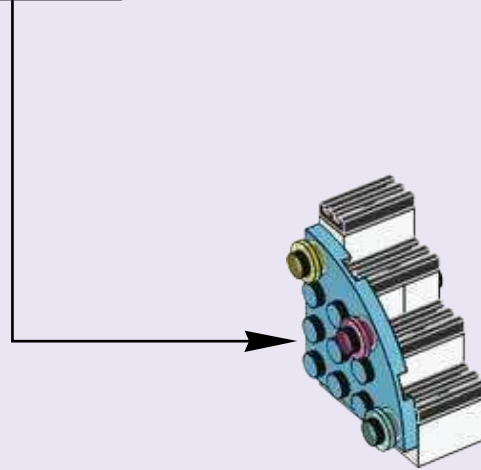
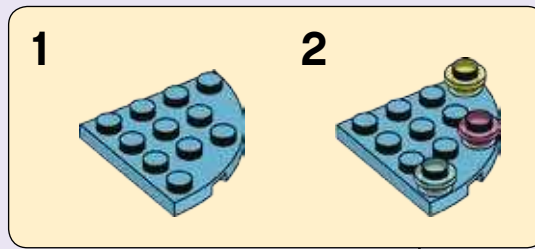

20

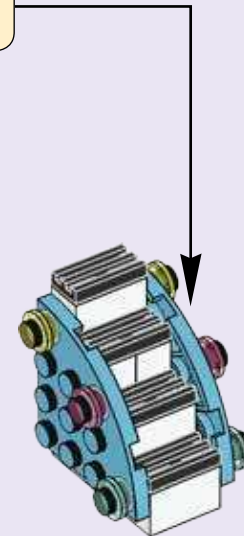

21

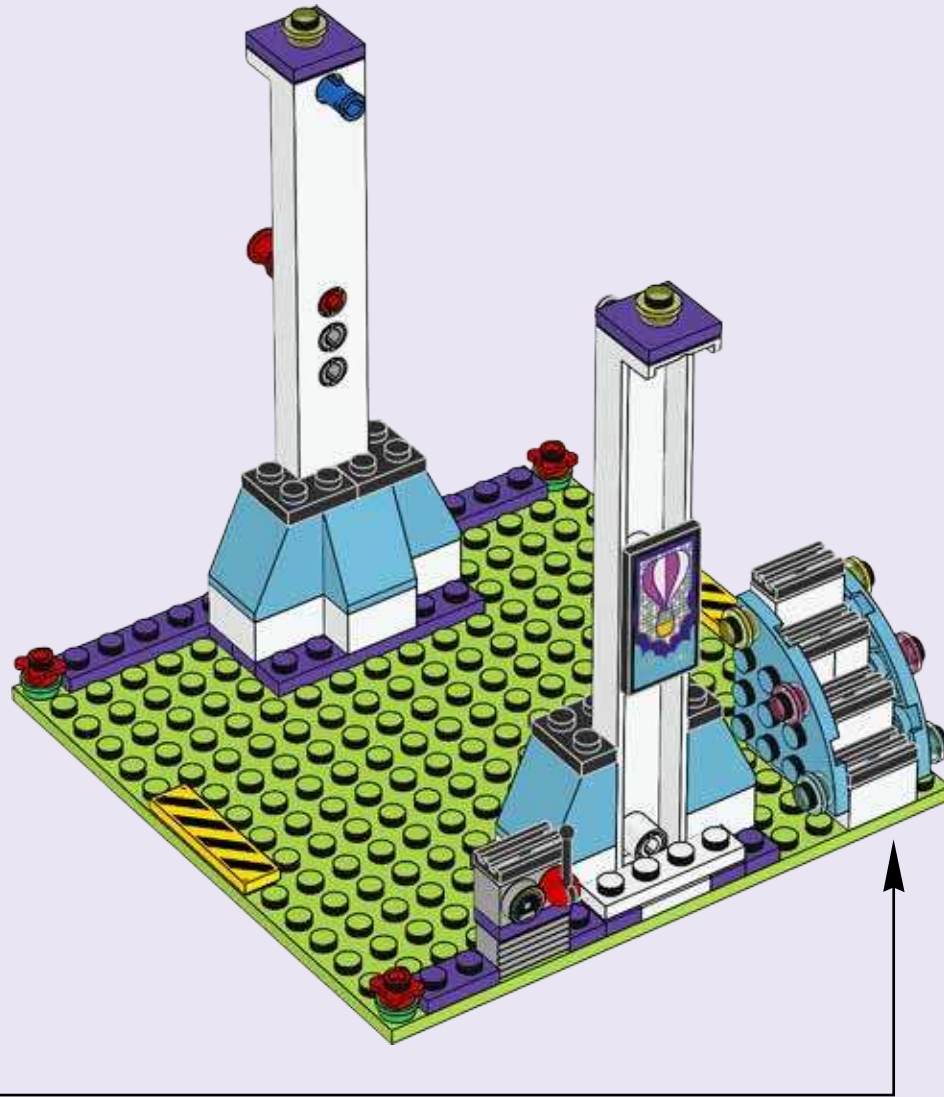

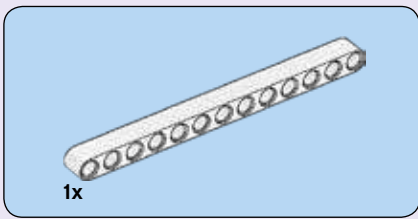

22

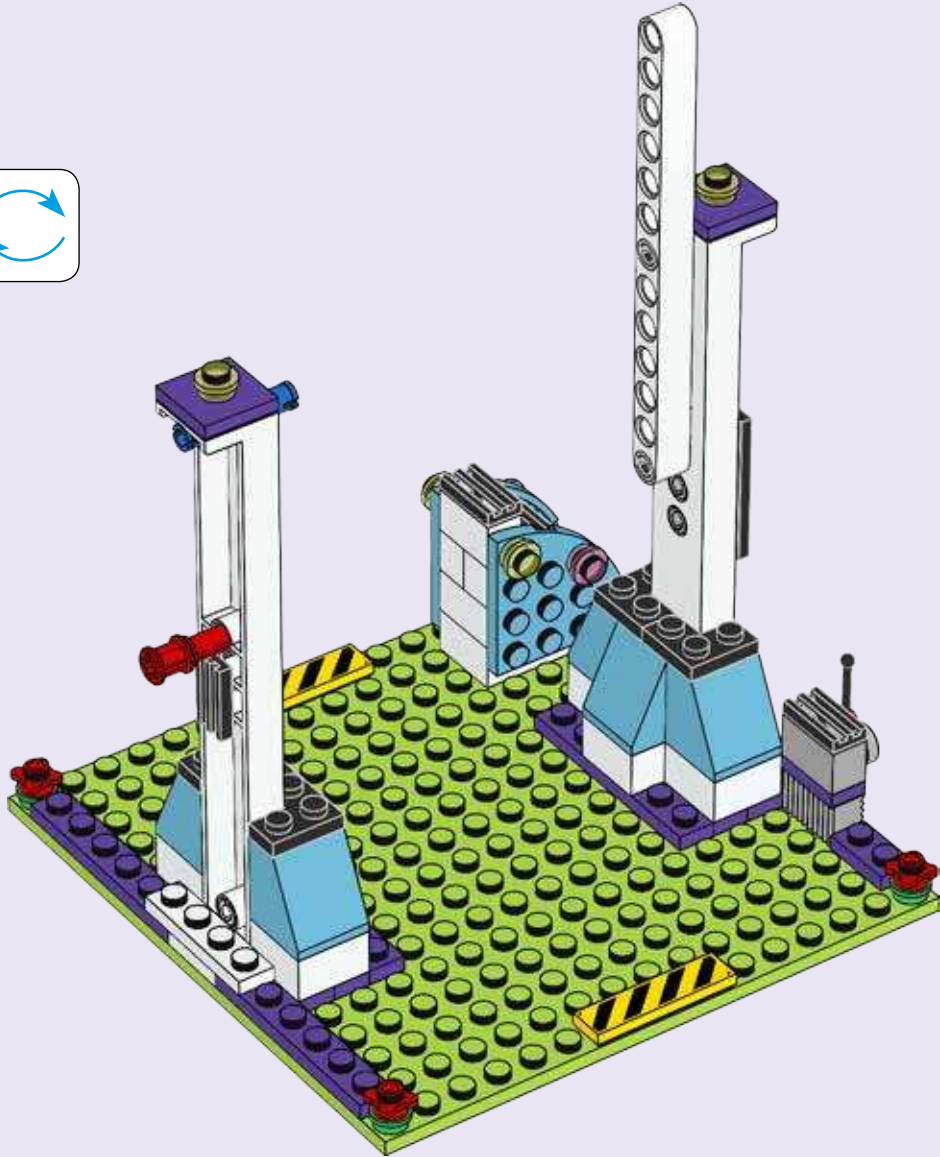
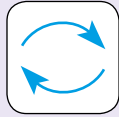

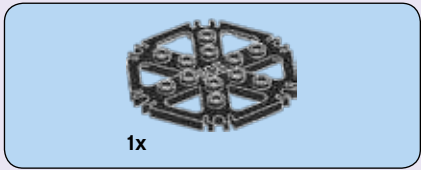
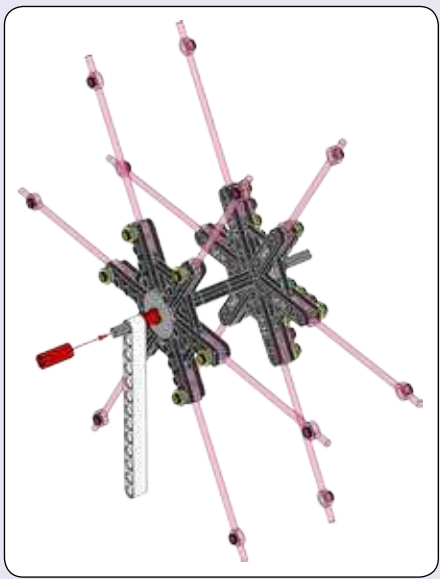

1x

23

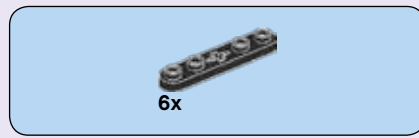

6x

24

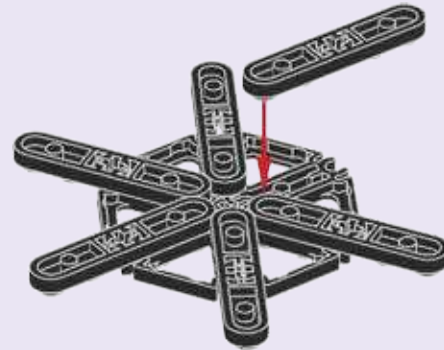

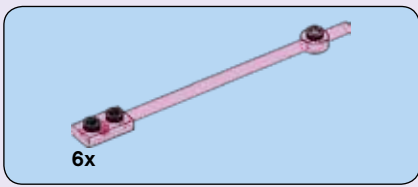

25

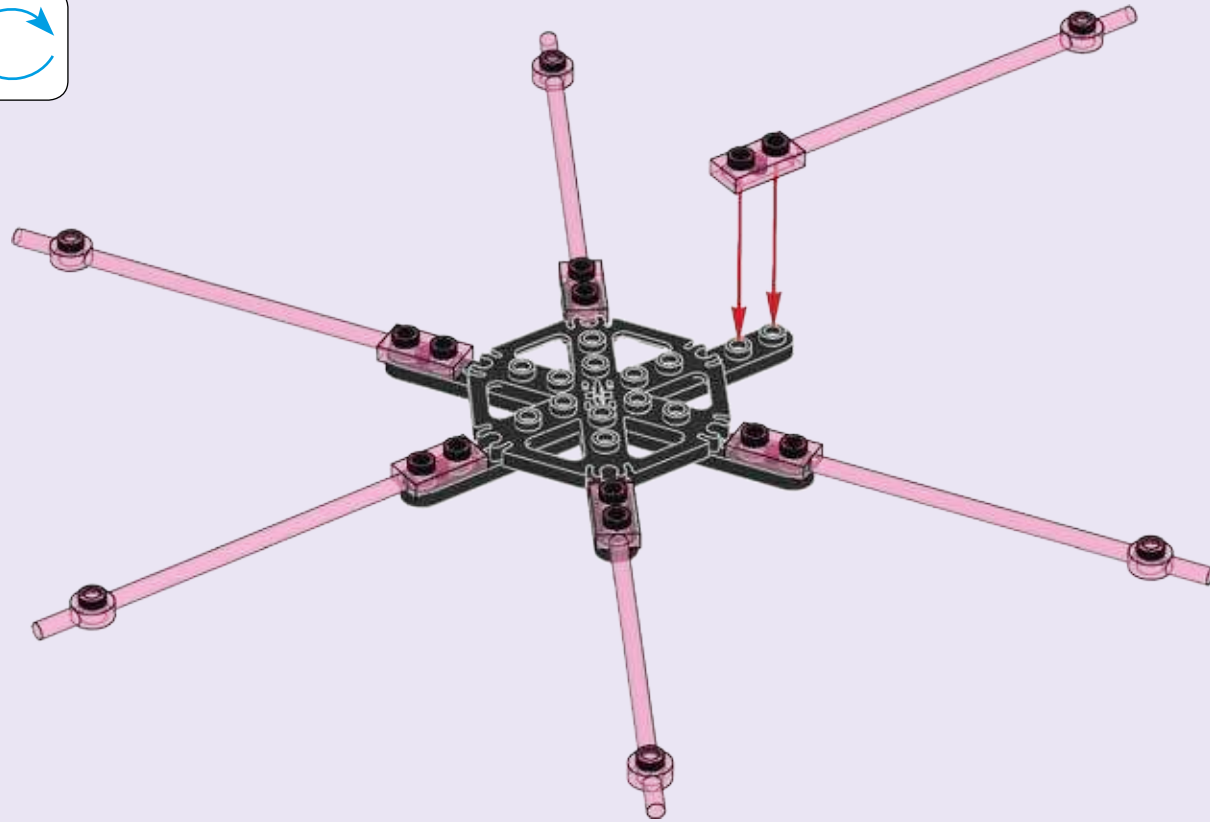
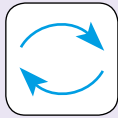



26

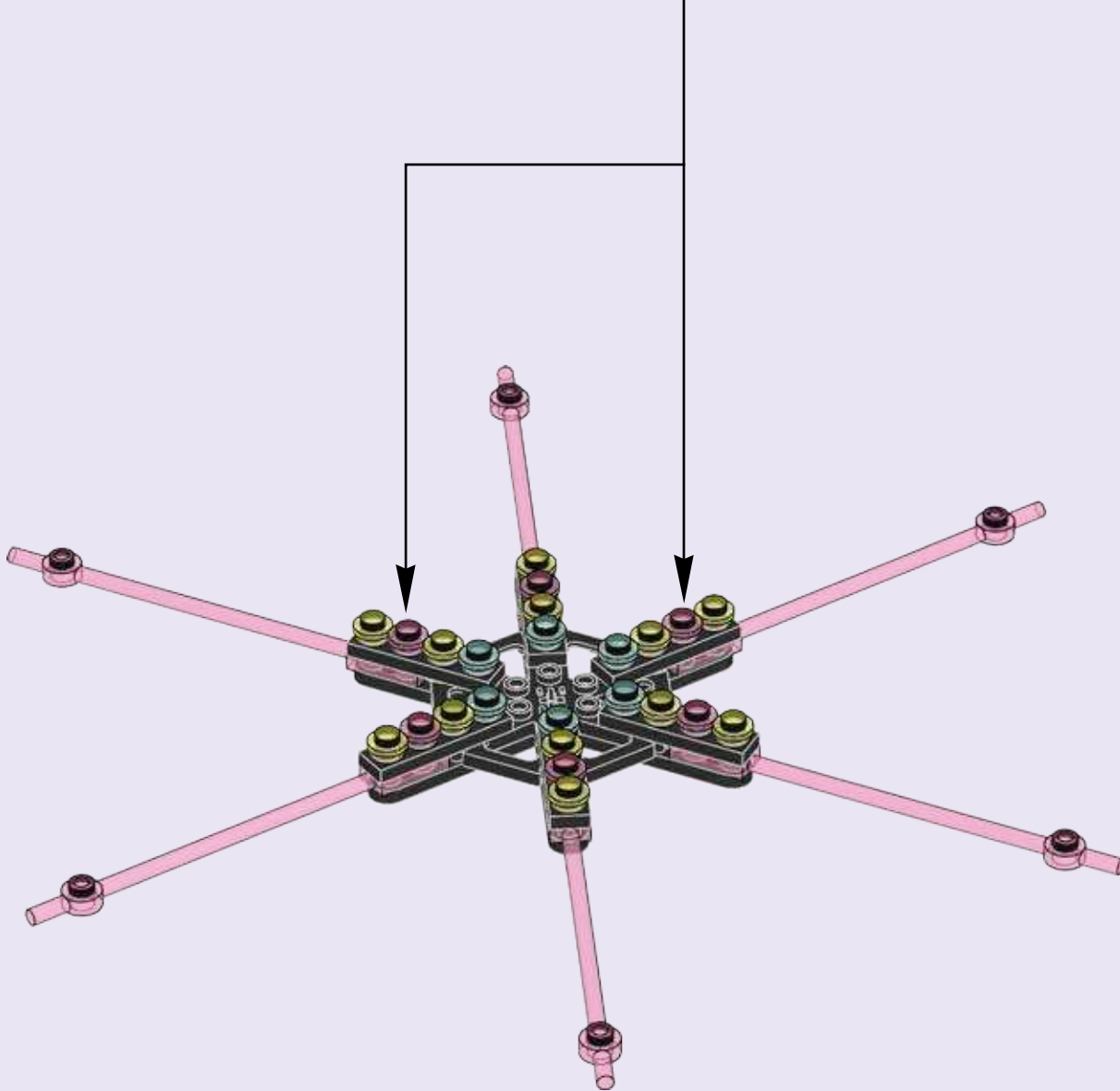

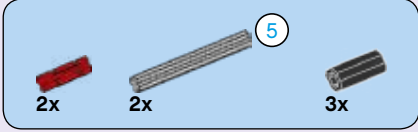
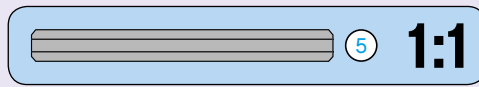

27

1

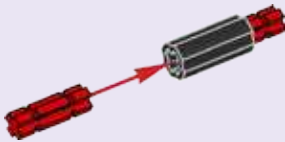

2

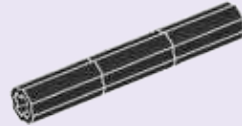

3

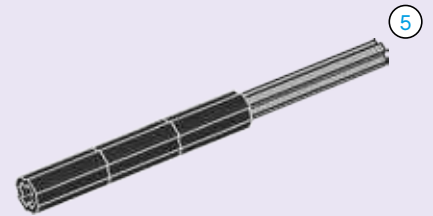

4

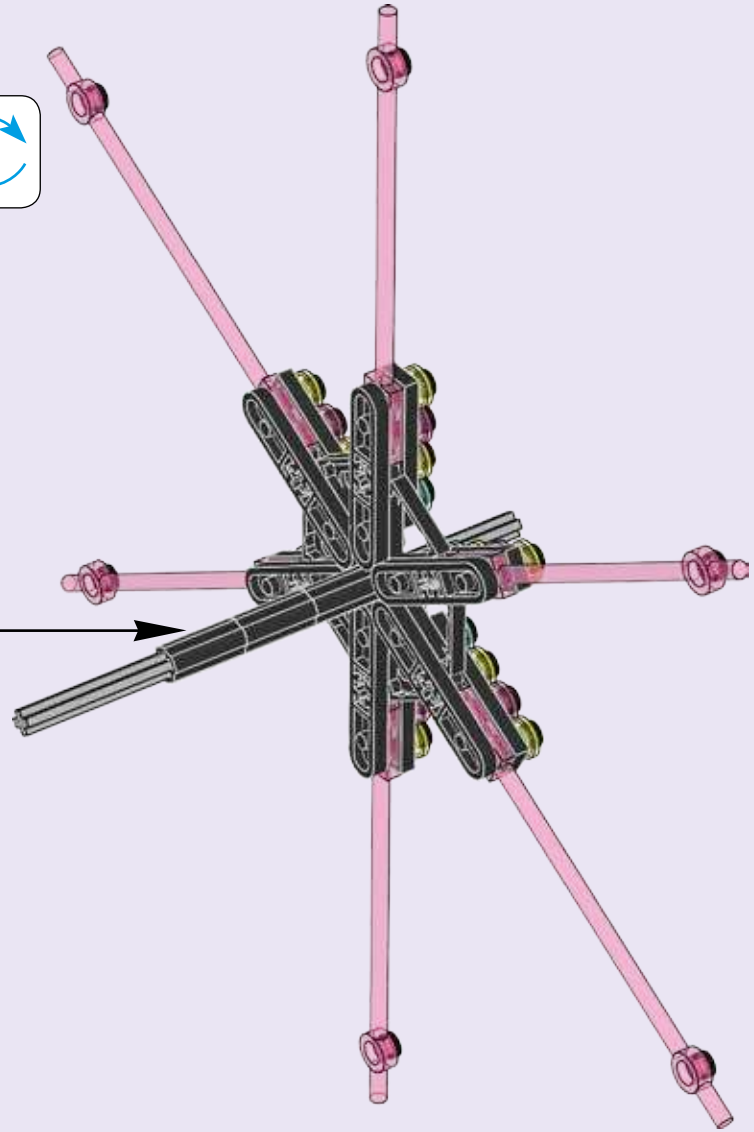
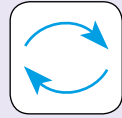
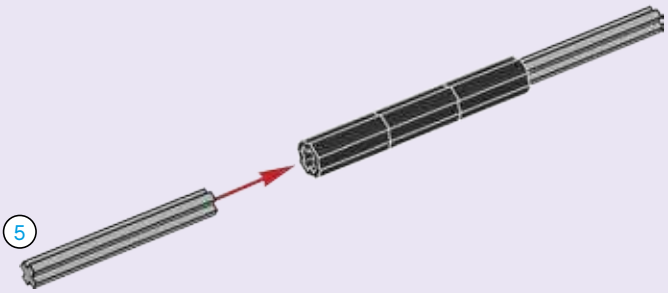

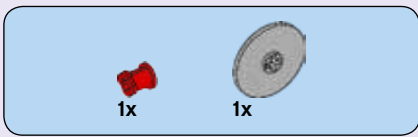

28

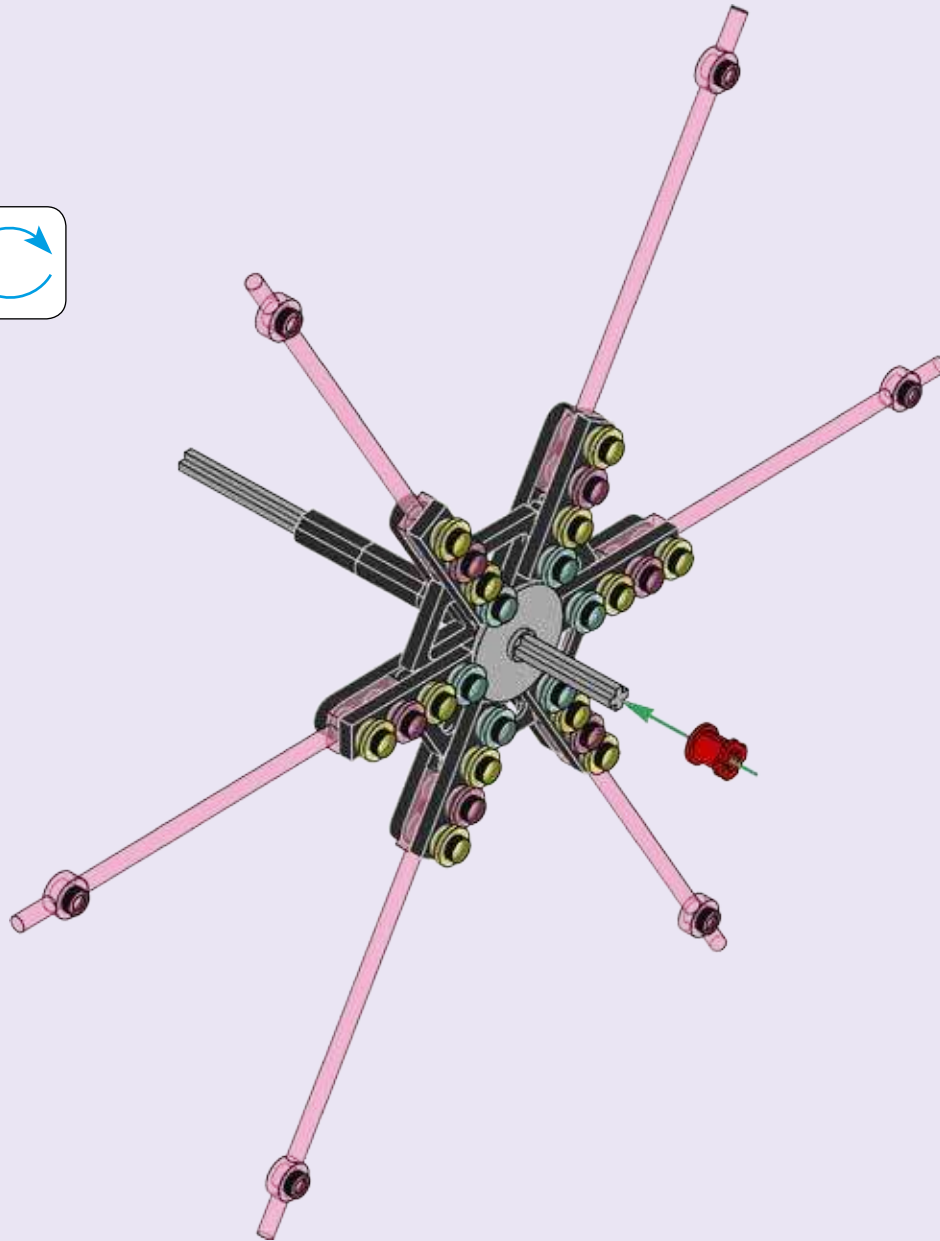
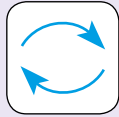

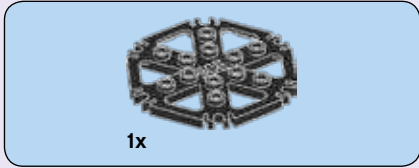
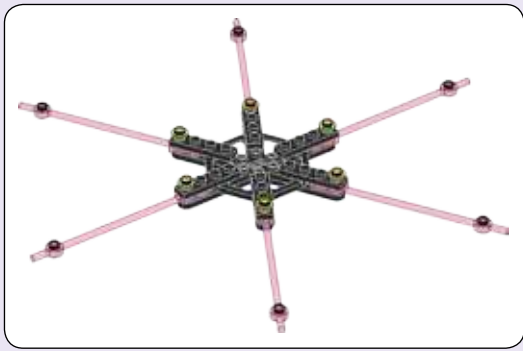

1x

29

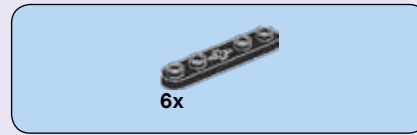

6x

30

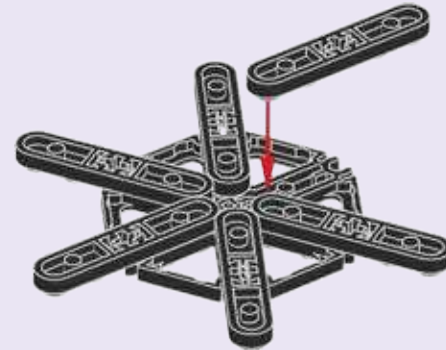

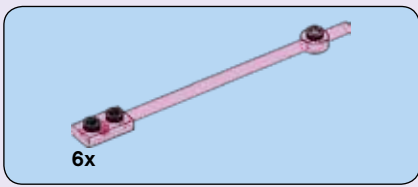

31

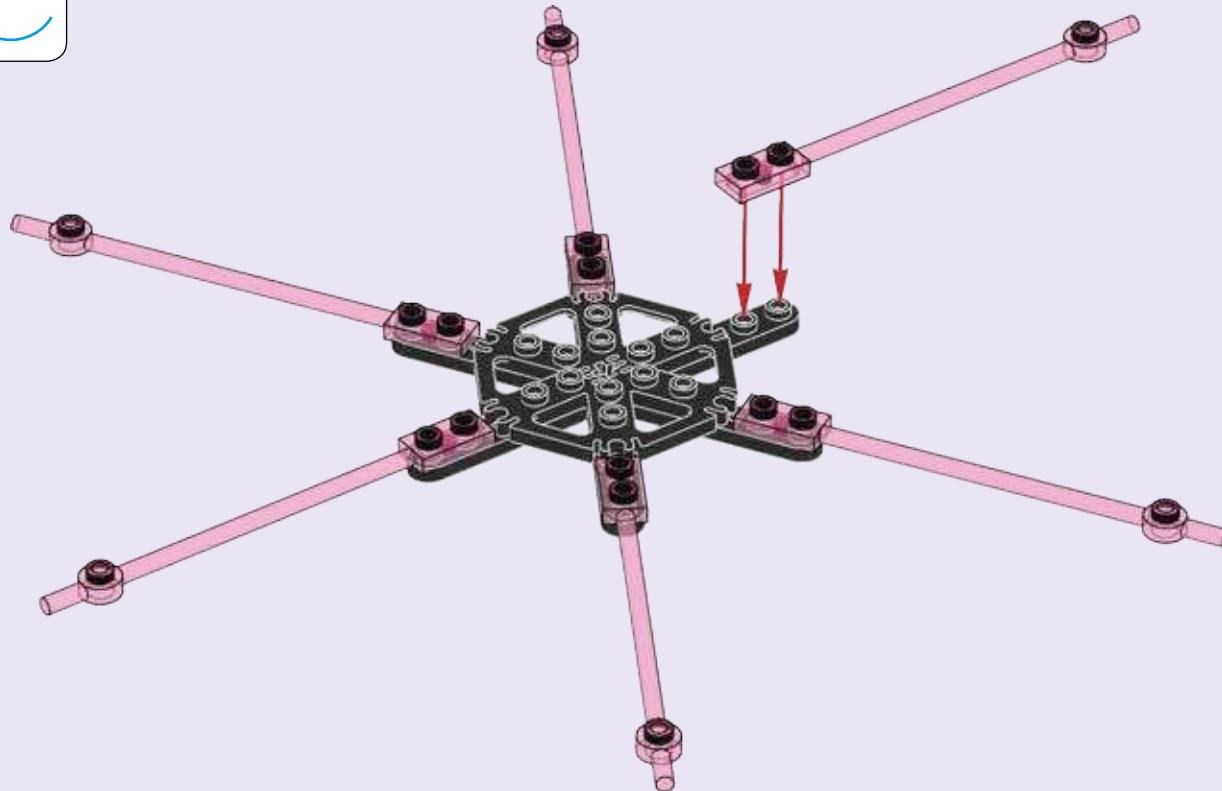
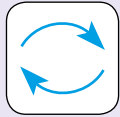

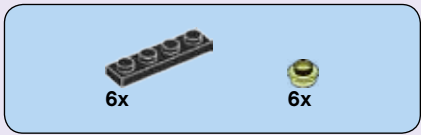

32

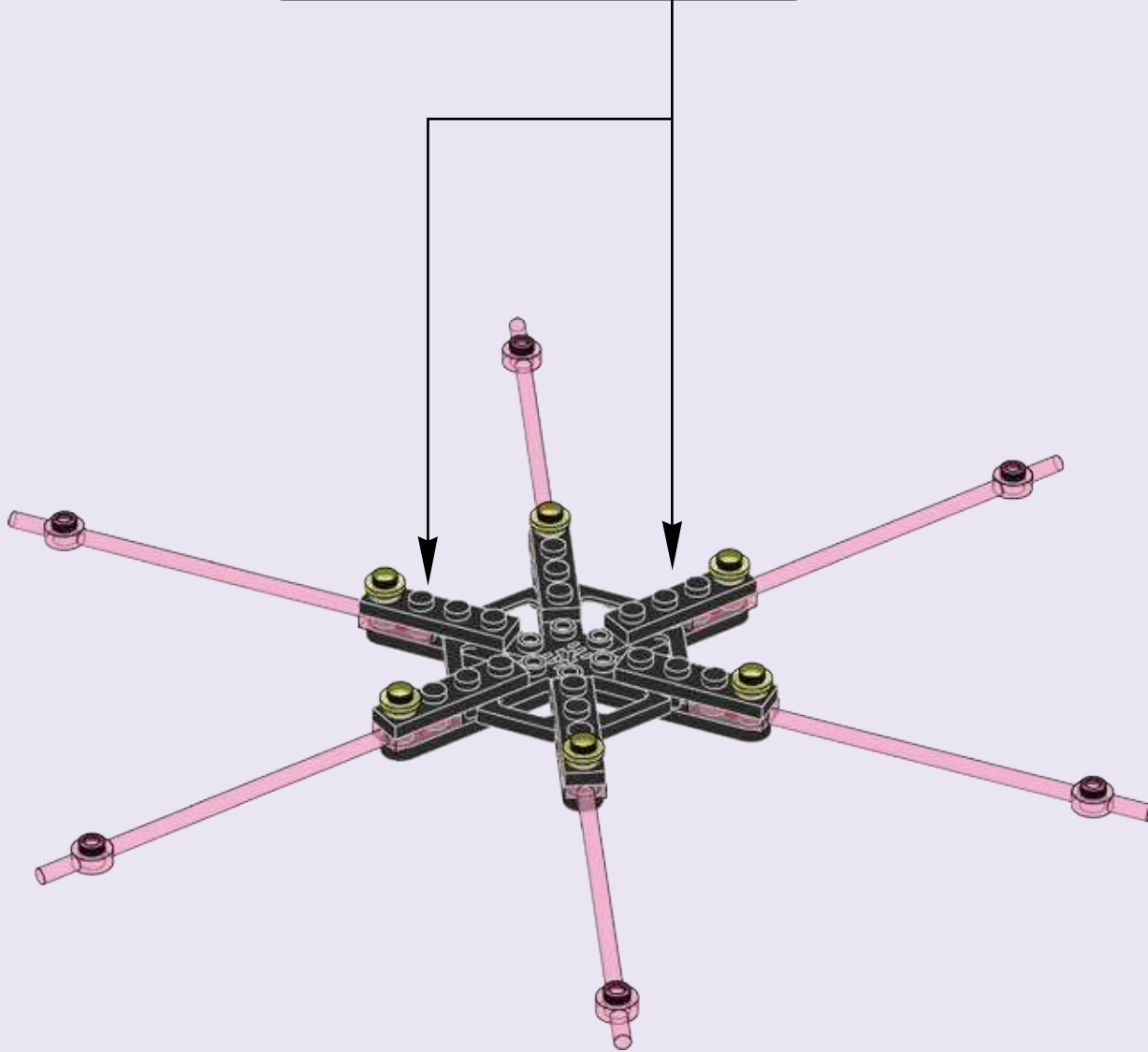

33

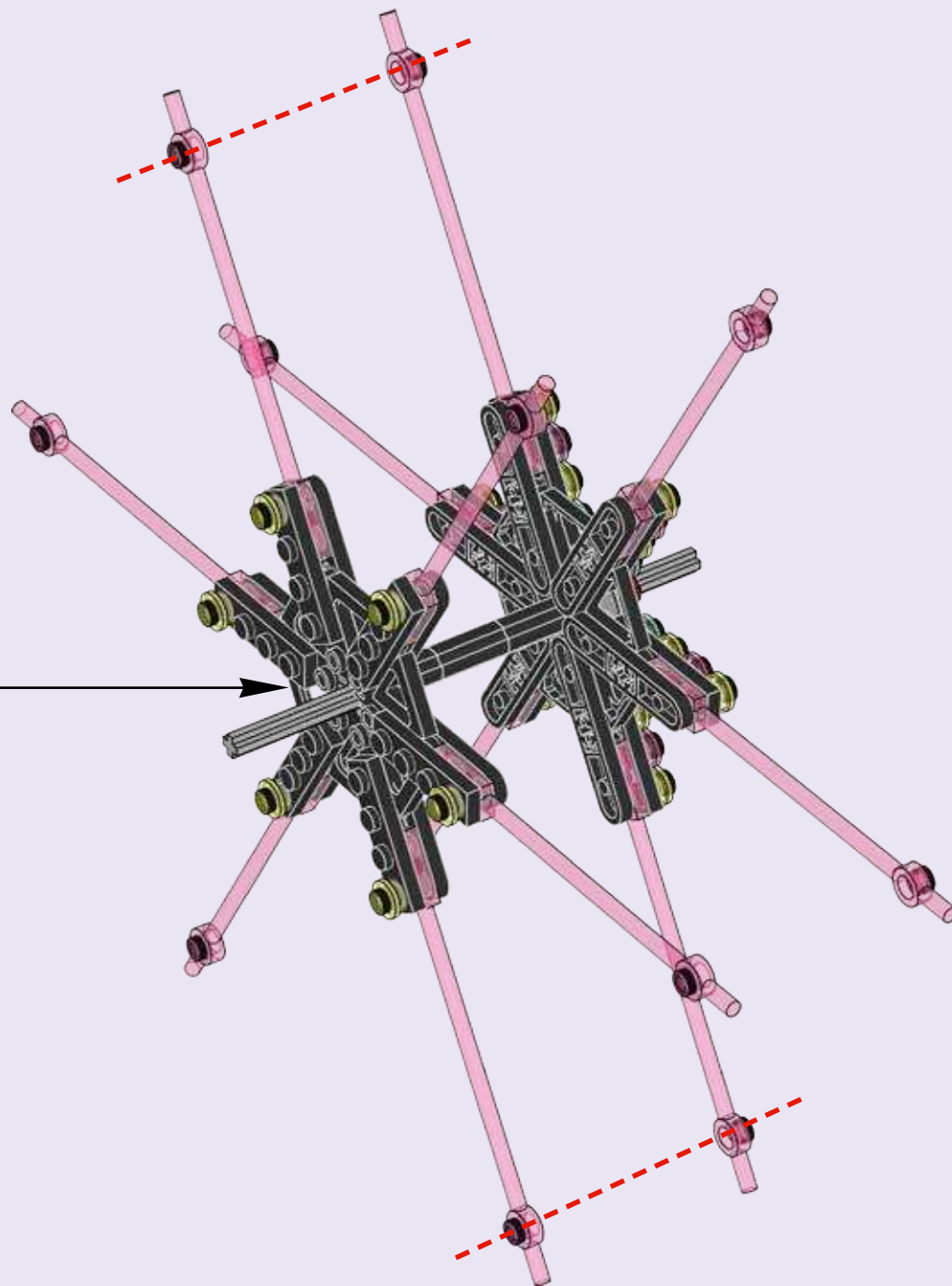
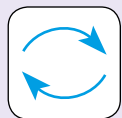

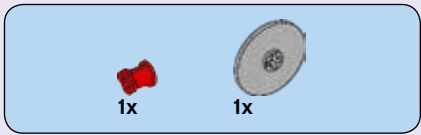

34

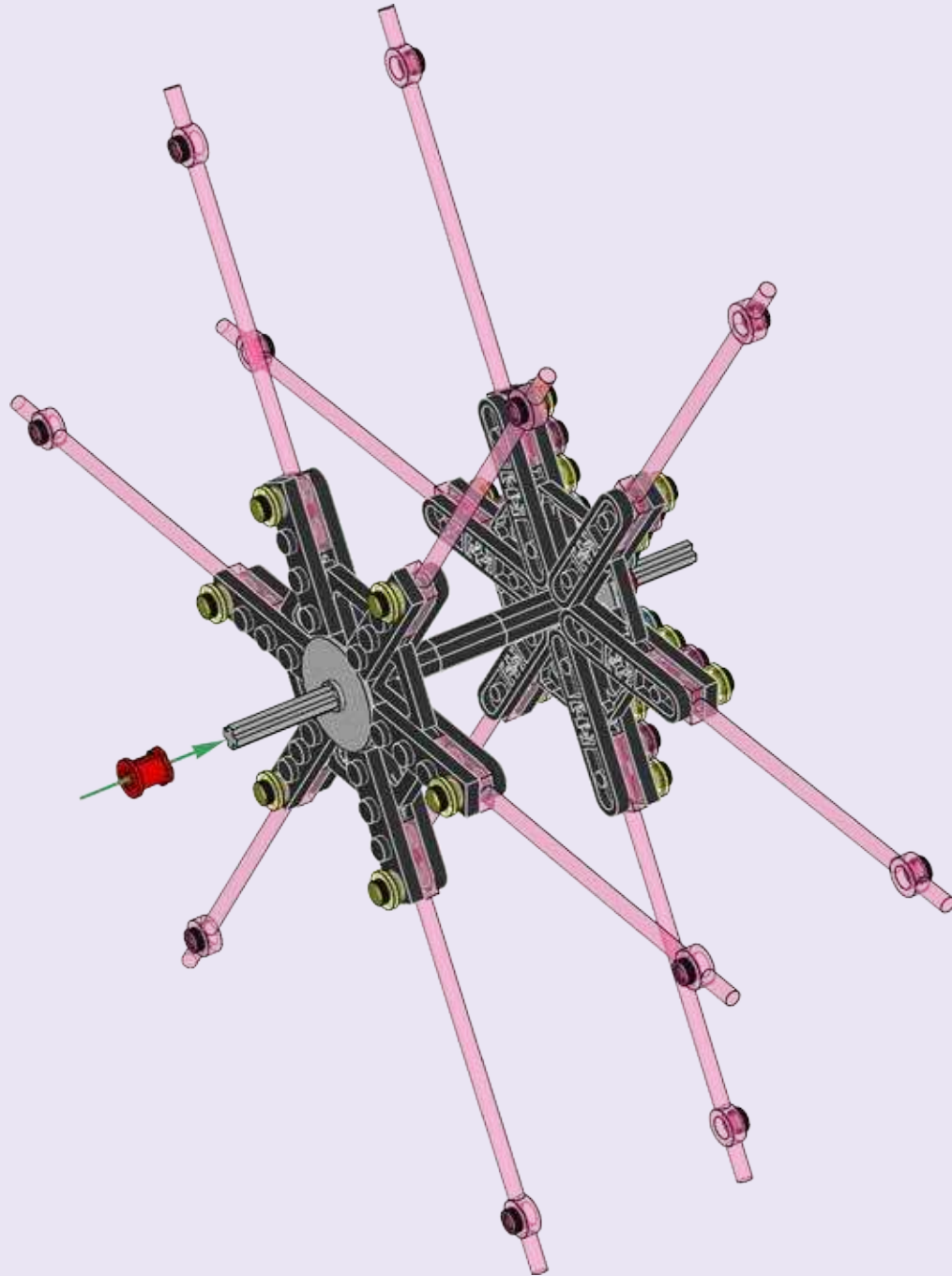

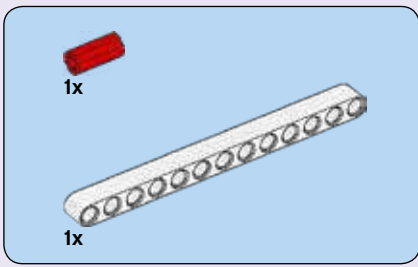

35

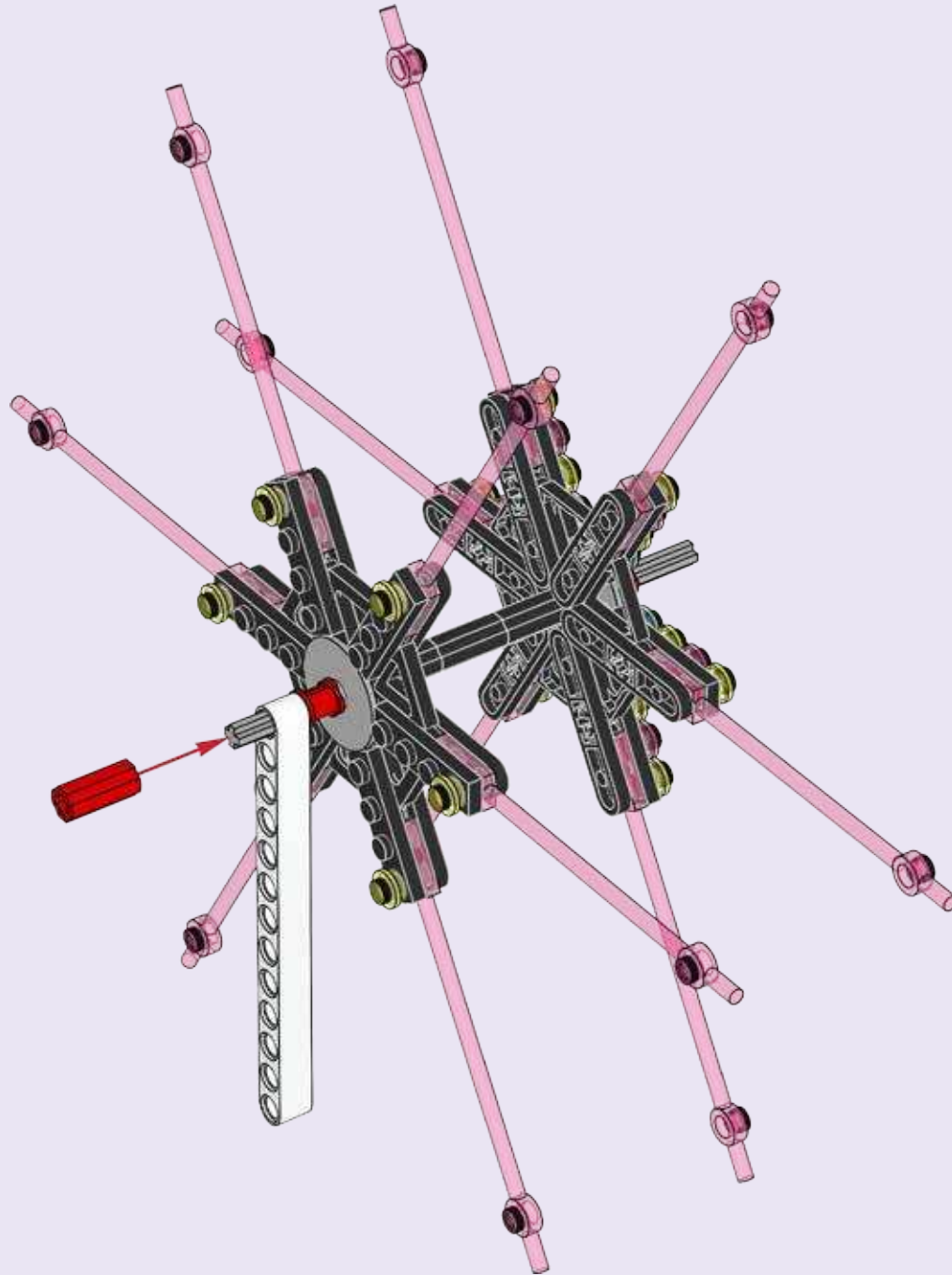

36

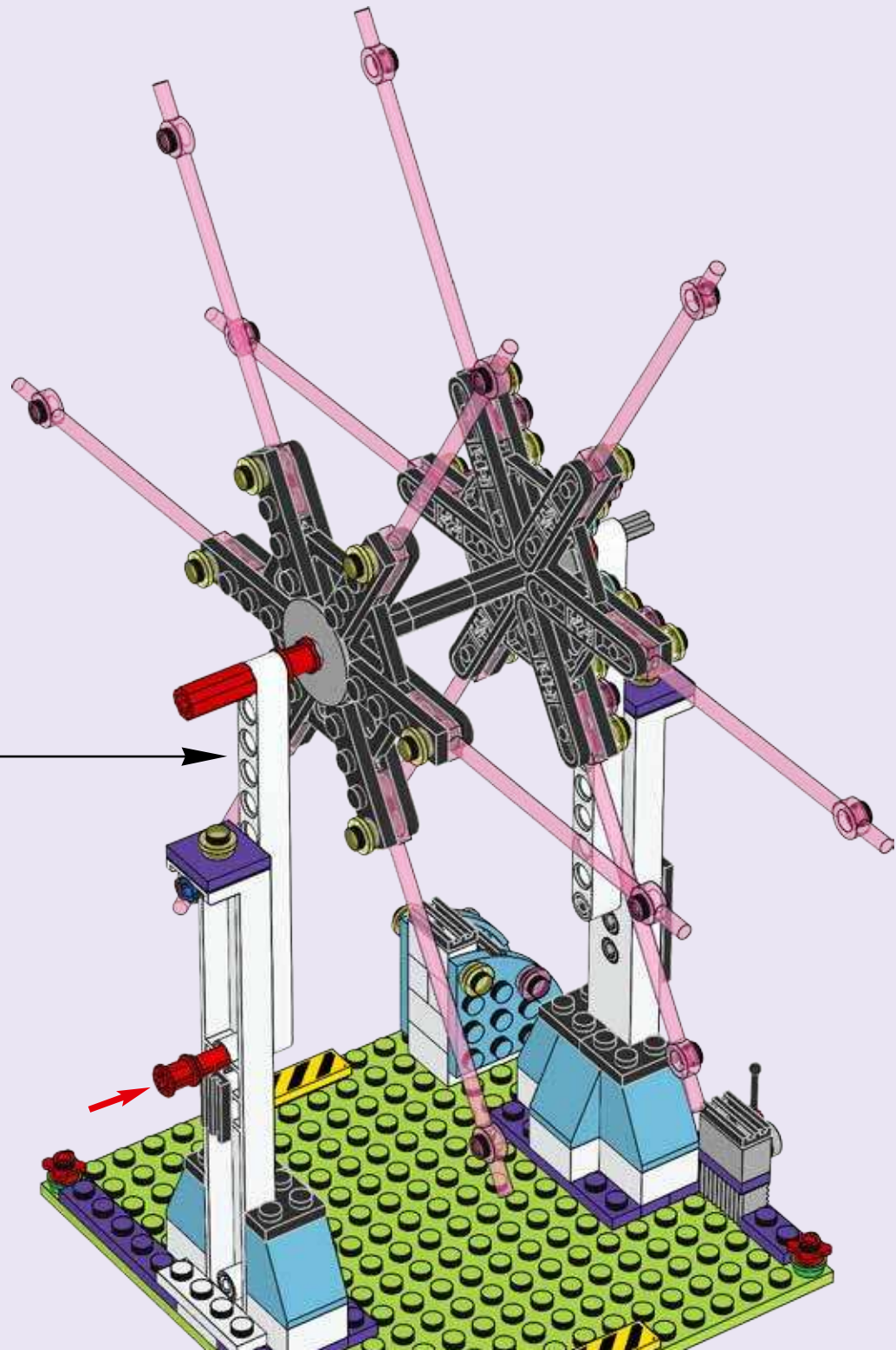



37

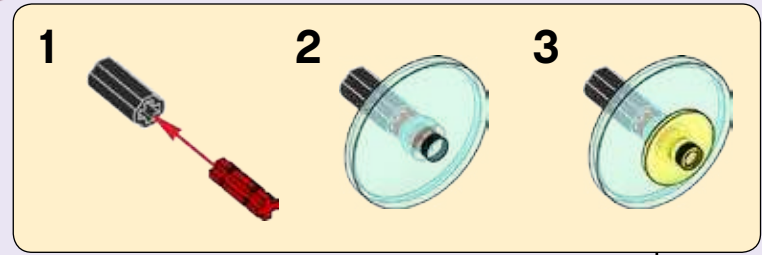
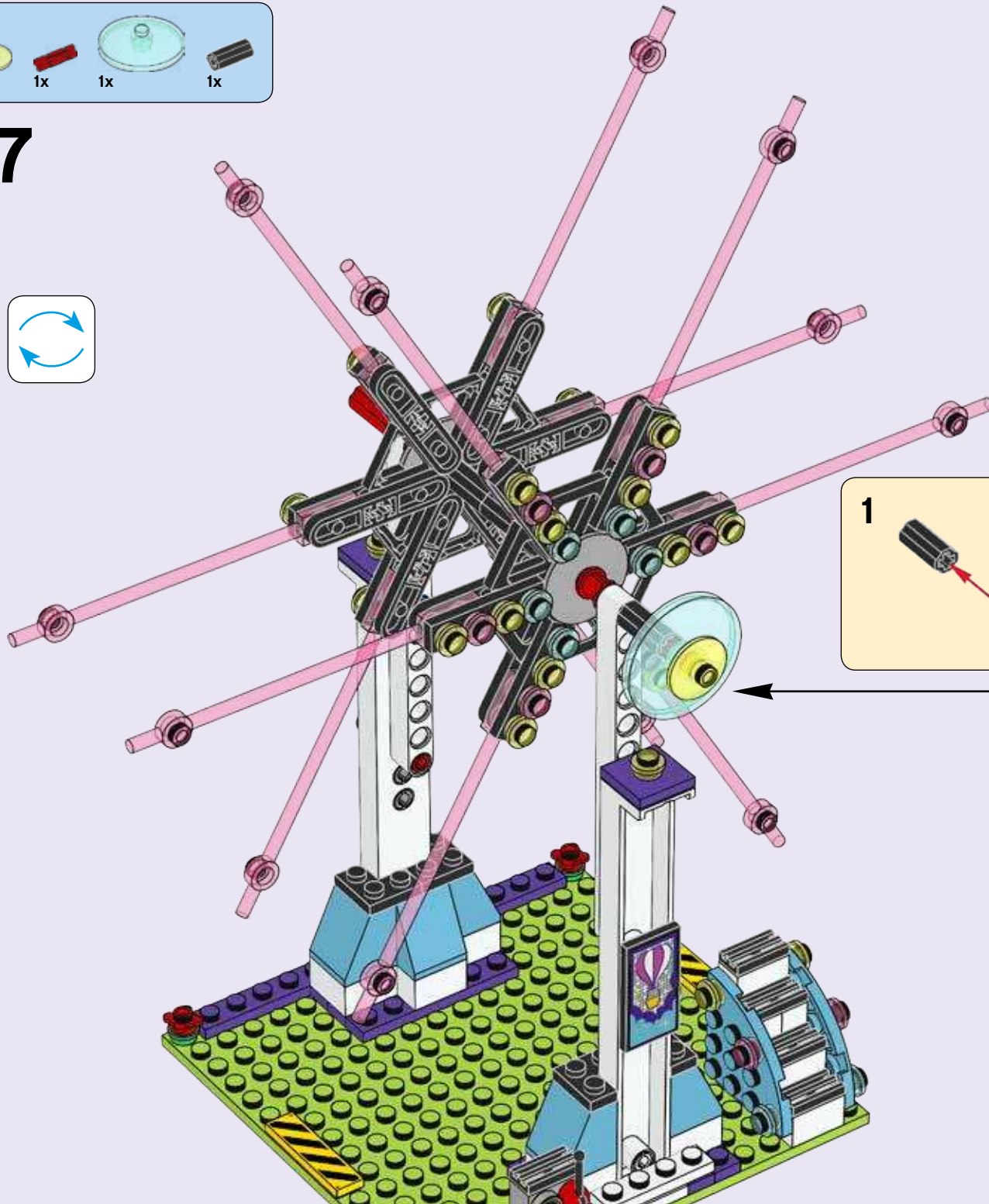

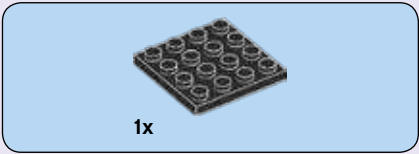
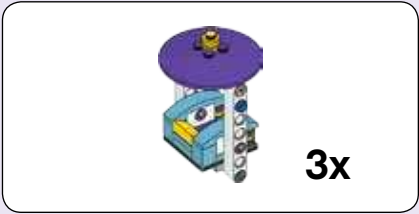
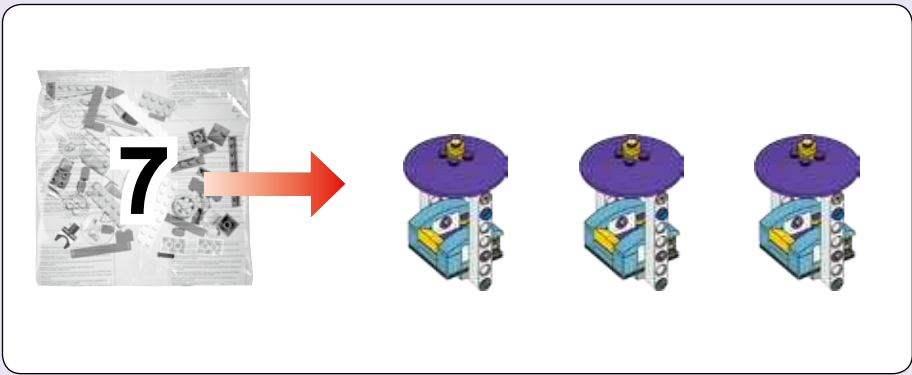

38

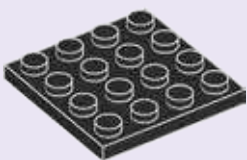

39

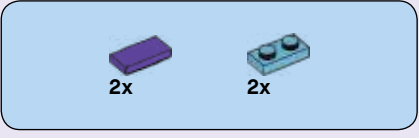

40

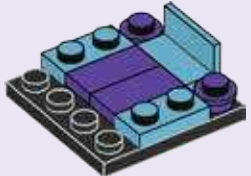



41

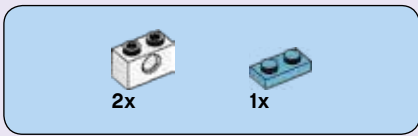
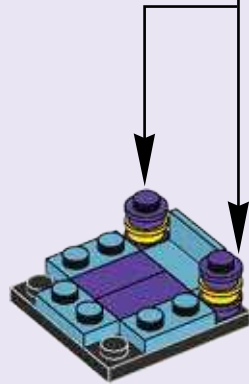

42

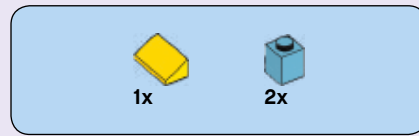
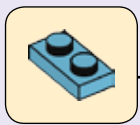

43

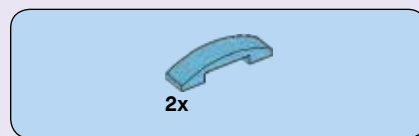

44

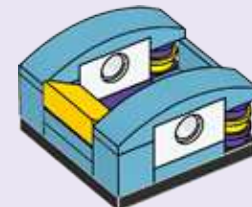

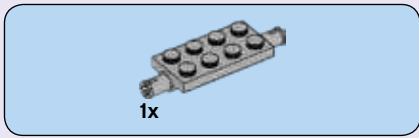

45

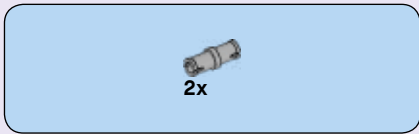
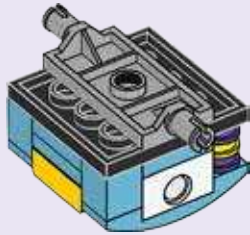
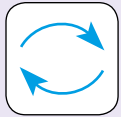

46

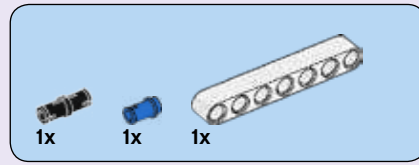
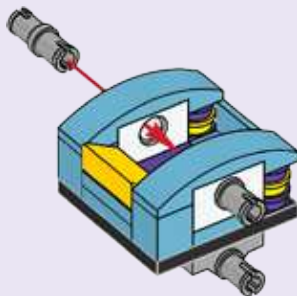
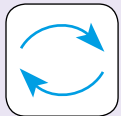

47

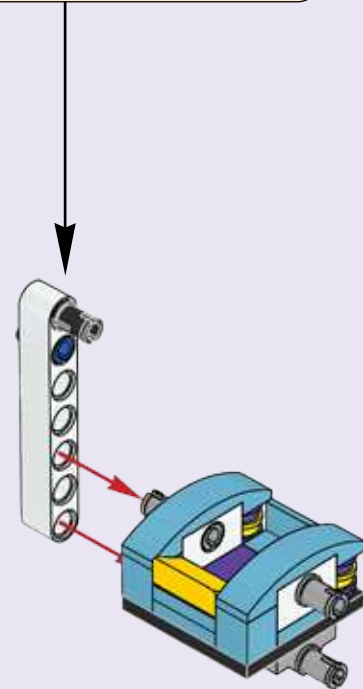
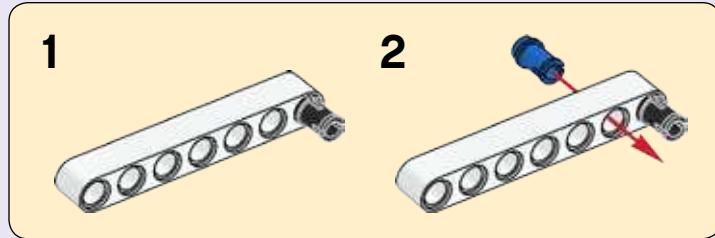

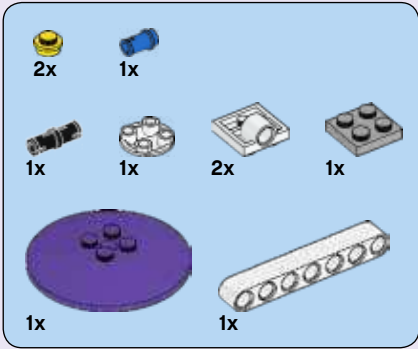
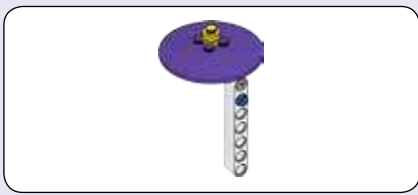

48

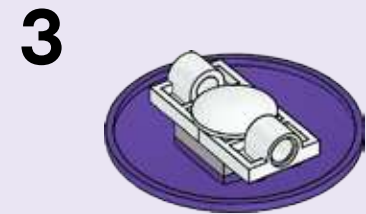
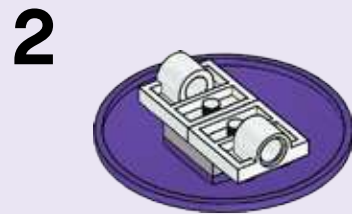
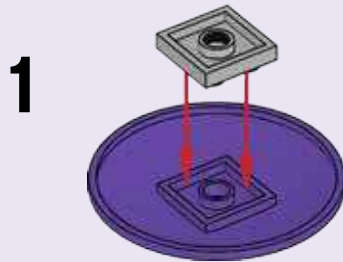

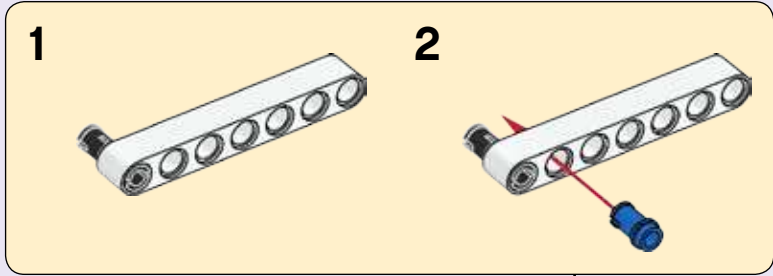

4

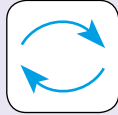

5

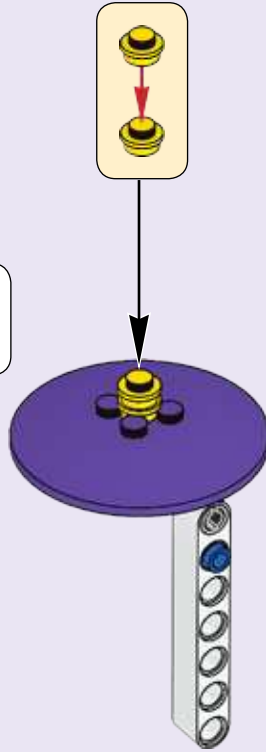

6

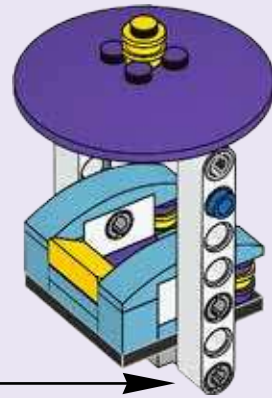

3x

49

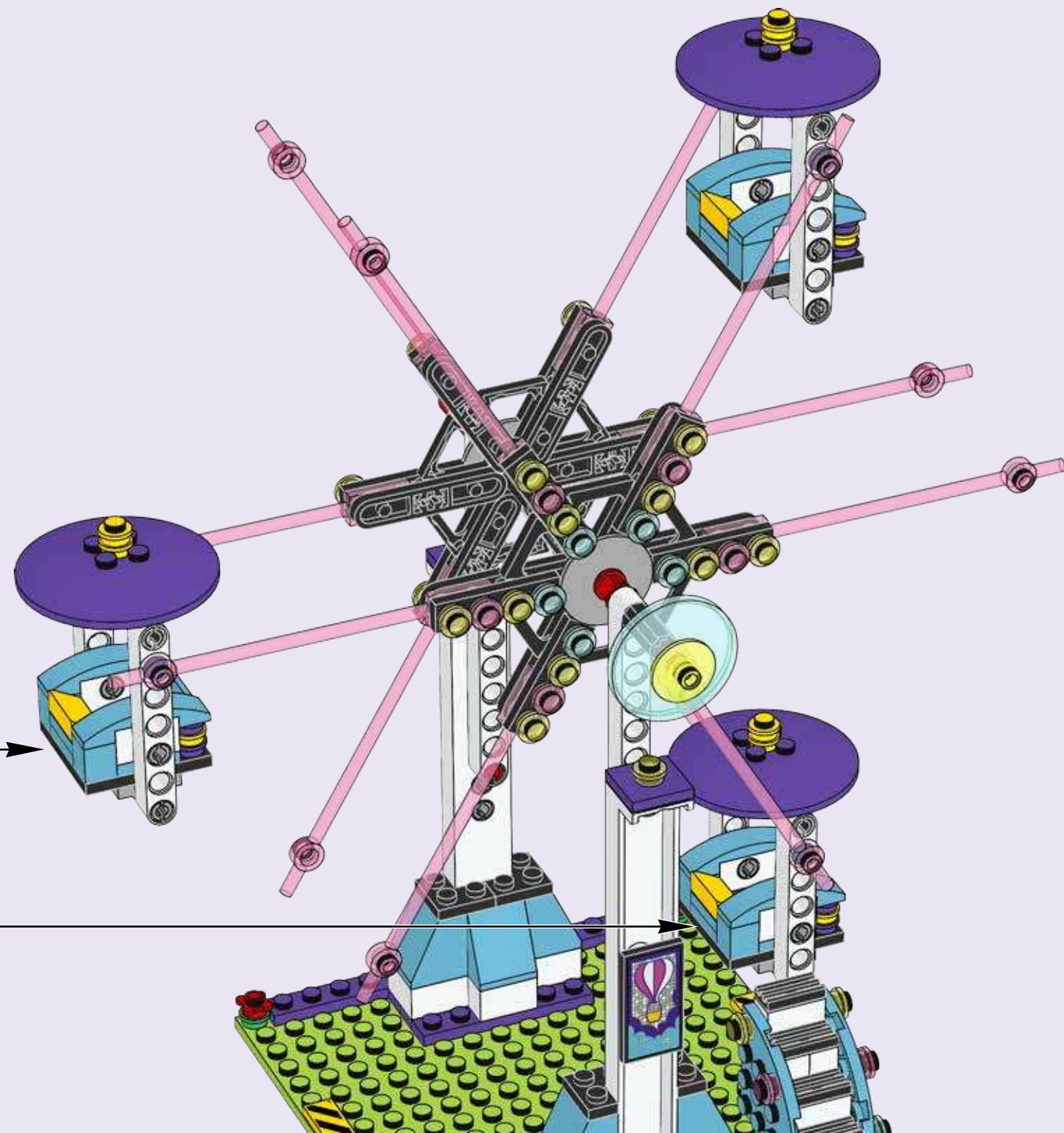

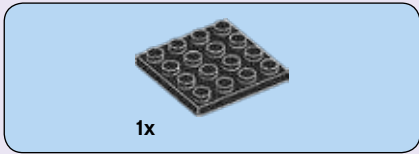
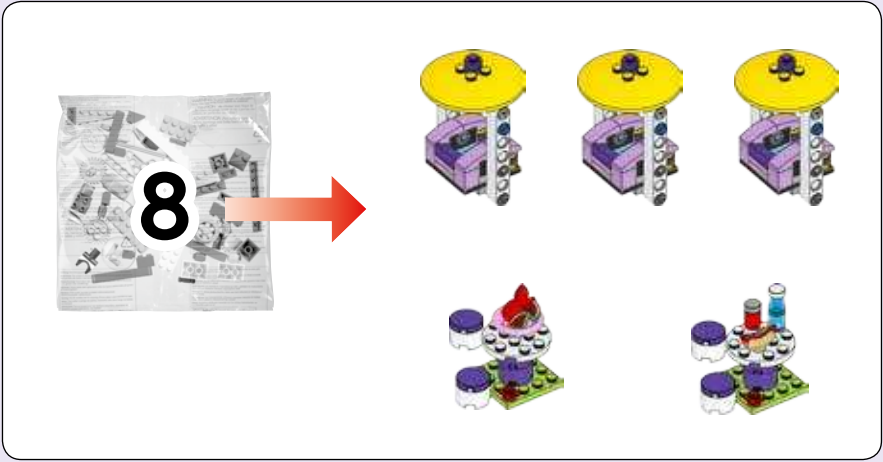

50

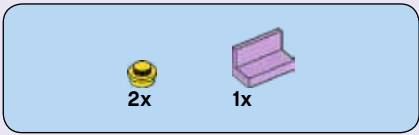
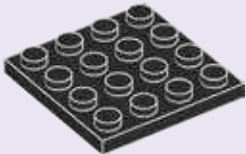

51

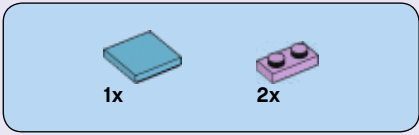

52

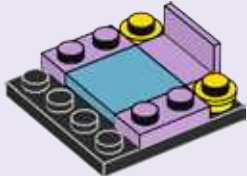

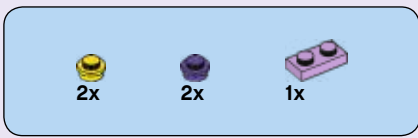

53

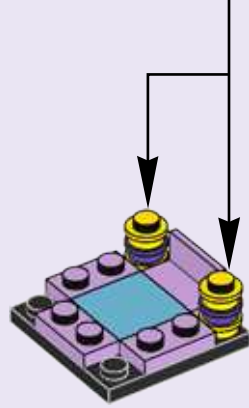

54

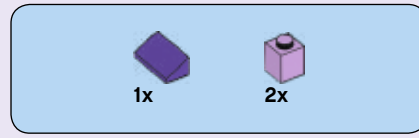
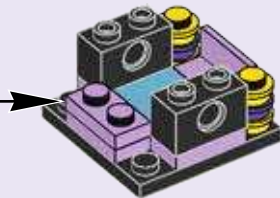
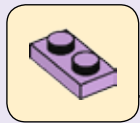

55

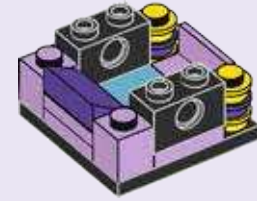

56

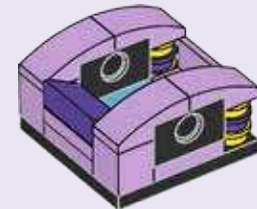

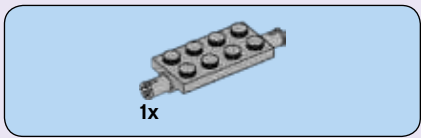

57

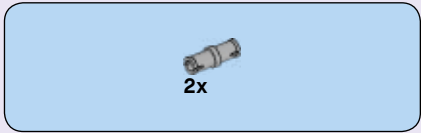
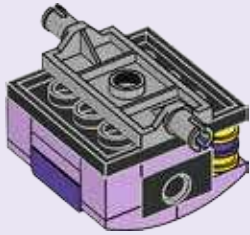

58

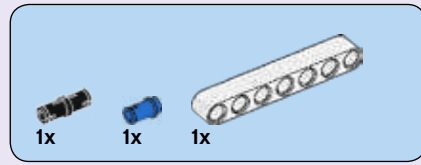
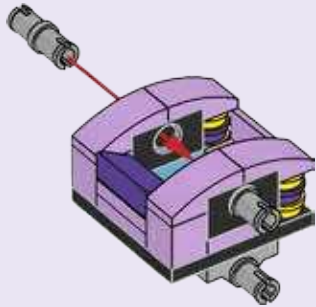

59

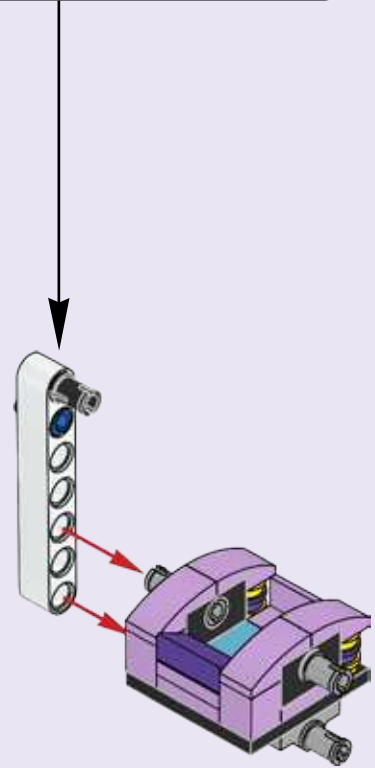
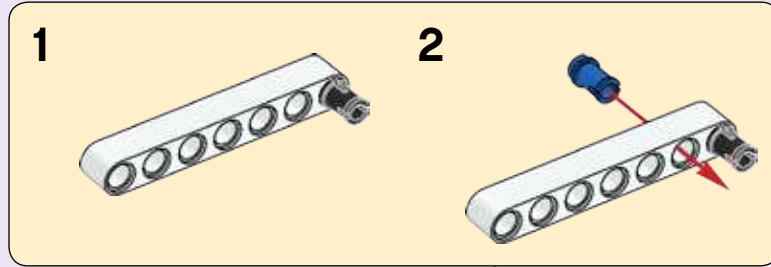

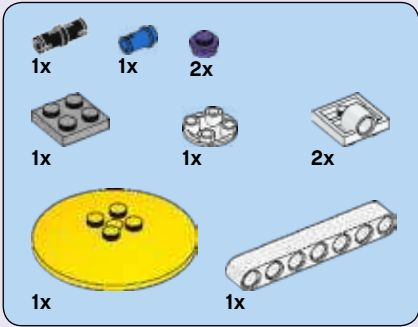

60

1

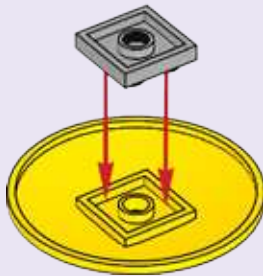

2



3



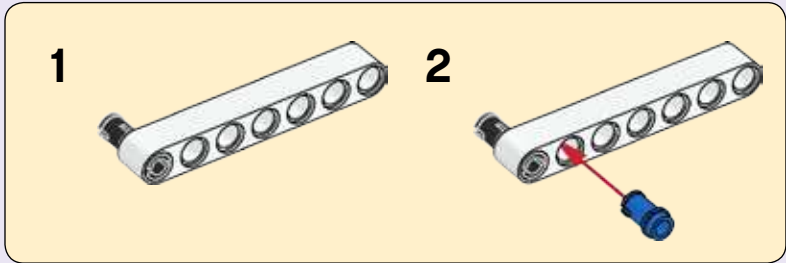

4



5

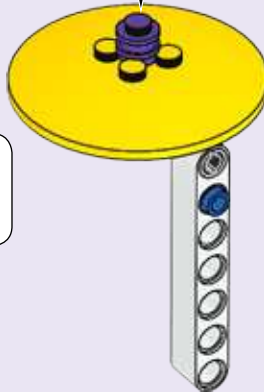
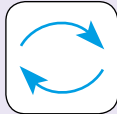

6



3x

61

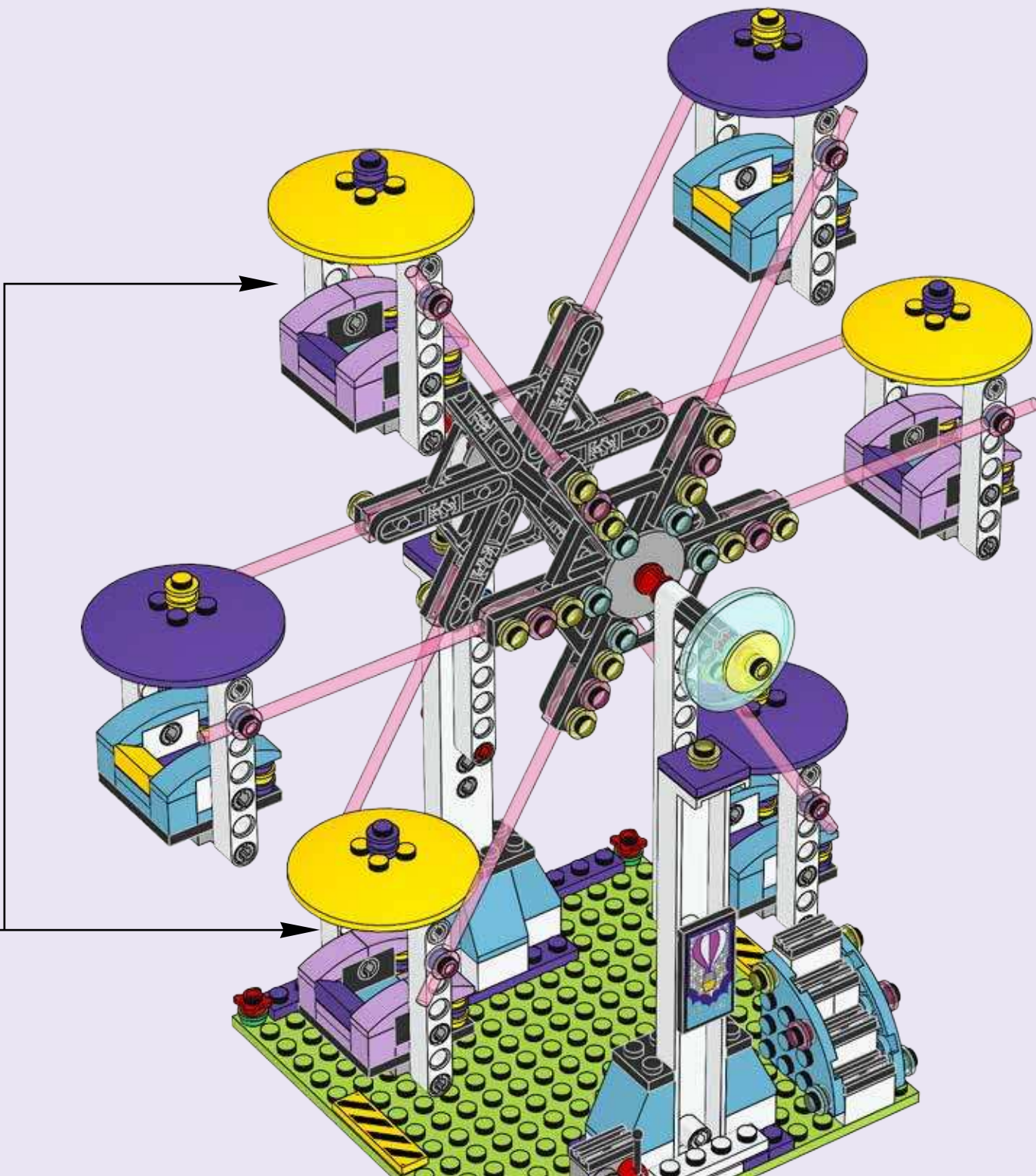



62

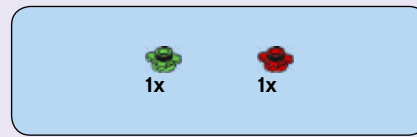
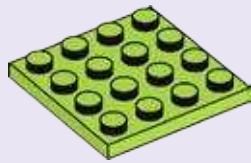

63



64

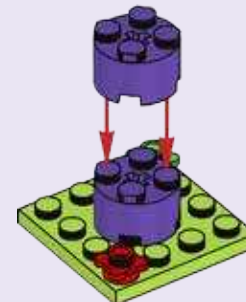

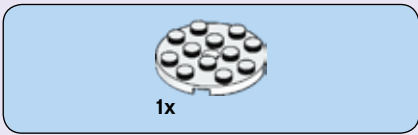

65

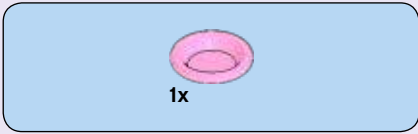

66



67

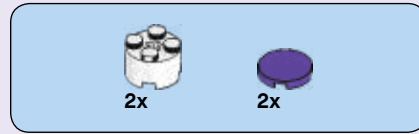

68

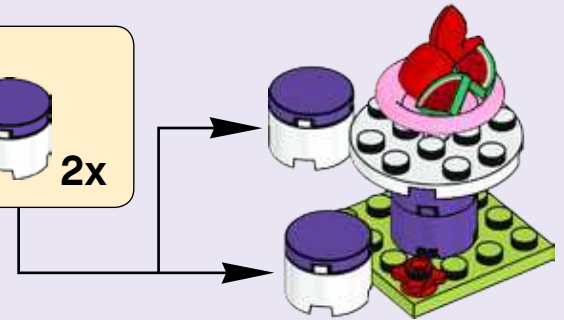



69

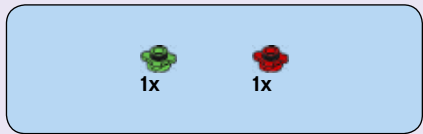

70



71

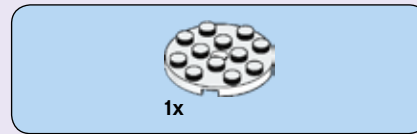
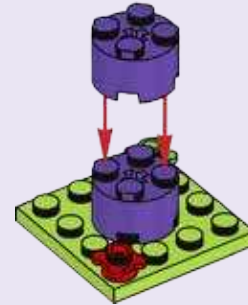

72



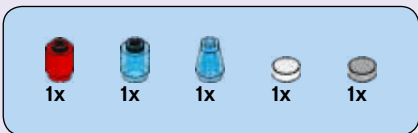

73

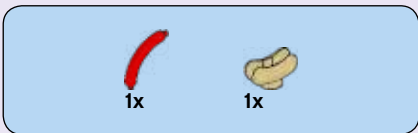
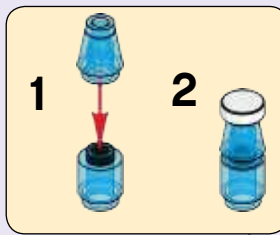
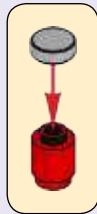

74

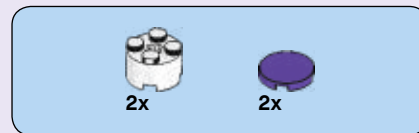
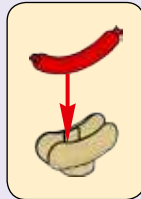

75

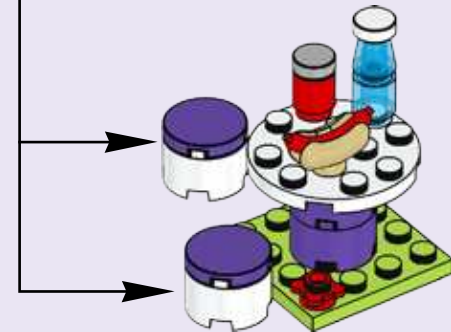

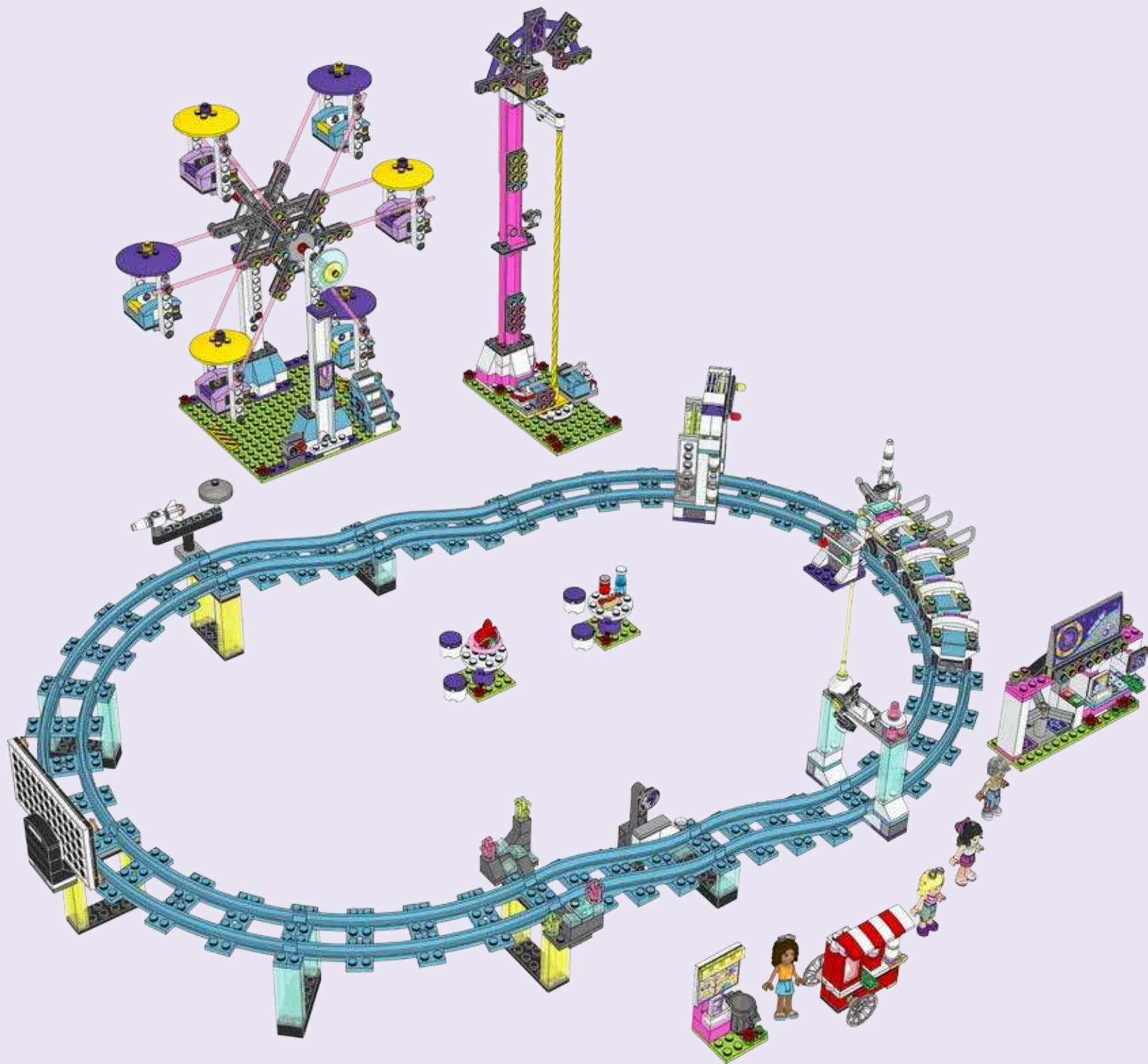



Friends



■ 41130



■ 41129



LEGO.com/friends

1x 6121787
8x 306201
2x 4518400
2x 4646844
2x 625401
1x 4118981
1x 4125554
2x 6152581
2x 6054551
5x 4558952
8x 302401
1x 654101
4x 300501
2x 245301
2x 6025300
3x 4547489

1x 4216652
4x 614301
1x 6093053
2x 4233486
3x 4113261
1x 243201
12x 300401
4x 4598527
2x 6058177
4x 609101
6x 370001
1x 306901
5x 302301
9x 241201
5x 6034044
3x 4121932

3x 4143137
2x 6097637
1x 4160228
3x 302201
1x 6126046
2x 306801
6x 303901
4x 4234525
5x 300301
12x 6061024
2x 235701
2x 6146985

3x 245401
1x 6035539
1x 4544140
4x 371001
4x 6023806
3x 4515347
2x 6102776
3x 302001
1x 300101
4x 366601
2x 4620761
4x 4658973
1x 362301

1x 617901
6x 4278271
2x 379501
12x 4495927
1x 6062279
1x 6013938
1x 6147214
3x 4666579
2x 6024495
3x 4113917
1x 4217562
1x 4514554
1x 6131896
1x 4159739

14x 6035617
2x 4227155
2x 300521
1x 6144805
1x 6054438
4x 4142865
1x 4513174
3x 6029946
2x 6132807
1x 4140806
2x 4515365
2x 243121
2x 389421
23x 4143005
1x 4514553
24x 614124
1x 4239601

1x 306221
3x 4550348
2x 4119091
1x 366624
3x 6110037
1x 6147018
2x 74335
8x 614126
1x 6066102
3x 300526
12x 302426
16x 4295370
1x 4184169
2x 4537551
1x 6079894
1x 6070695

1x 474026
16x 4121715
2x 4106552
1x 6096109
4x 4512363
1x 4526982
2x 306926
6x 241226
1x 6092585
6x 370026
2x 4505757
2x 6000650
3x 6016172
1x 6055630
4x 302226
3x 306826
6x 242026

1x 370526
4x 243126
1x 4613153
16x 371026
2x 301026
2x 6037746
1x 303726
1x 6045912
12x 4114689
10x 302026
3x 4560182
6x 4243819
4x 4181144
7x 379526

2x 4539442
1x 4495935
2x 346026
3x 4569058
2x 6151225
2x 4295260
15x 4619599
3x 4650498
2x 4536998
2x 4278412
1x 6054554
1x 6139647
1x 4497943
1x 4646864
1x 3003941
27x 4163917
2x 6052994

11x 6073445
2x 6051918
4x 4640026
6x 4283915
1x 4667222
1x 4293877
1x 3006843
1x 4567331
2x 3005747
5x 4646860
1x 4216384
43x 3005749
10x 6076751
1x 3006349
10x 6102038
6x 6066338

1x 6030742
1x 256949
3x 6125698
34x 4599535
1x 6114993
2x 6099532
12x 6147035
4x 4504850
2x 6112967
6x 6097053
3x 6147006
12x 6099190
12x 6097647
2x 6051541

1x 6023827
1x 6126002
1x 6096991
1x 6151298
1x 6141743
3x 4650260
4x 4211483
1x 4211622
1x 4211535
1x 4211552
1x 4211375
14x 4211807
8x 4211383
3x 4512360
1x 4526985
1x 4227776

4x 4211398
2x 4211437
1x 6015344
1x 4228198
2x 4657366
2x 4654580
2x 4667578
1x 4502595
2x 6093527
1x 4211376
3x 4530469
6x 4211397
4x 4211365
2x 6045988
1x 4211815

1x 4211865
1x 4558169
8x 4211504
1x 4211529
3x 4211584
2x 6015347
2x 4211395
1x 4211444
2x 4211639
6x 4211572
1x 4535768
3x 4211406
1x 6115046
1x 6100030

1x 4211098
1x 6055313
4x 6039479
4x 4211135
2x 4210697
1x 4583879
2x 4211104
1x 4626645
3x 4211065
1x 4645730
1x 4210678
8x 6127601
5x 4621545
8x 6057387
3x 4517992



2x
6150314



2x
4621542



2x
6074906



1x
4618629



1x
6086923



24x
4566522



1x
6030534



3x
4566607



4x
6097501



4x
4622176



6x
4613192



2x
4655690



10x
4655695



4x
6057390



2x
4659770



2x
6047422



2x
6109766



2x
6030277



4x
6147010



6x
4655691



1x
6109819



3x
6117755



1x
6017024



1x
6017048



1x
6149684



1x
6049751



4x
6070746



1x
6096113



1x
4570481



10x
6057034



2x
6134621



2x
4626400



2x
6096717



1x
6017034



1x
6034812



1x
6073451



1x
6100431



1x
6078241



1x
6030333



2x
4617460



6x
4619652



1x
6139433



1x
6131878



12x
6097419



1x
4649741



11x
4618647



2x
6133911



4x
4625032



6x
6060857



6x
6109828



6x
6097093



2x
4655256



2x
6056271



1x
6146926



1x
6054390



3x
4620671



1x
4527977



1x
4654448

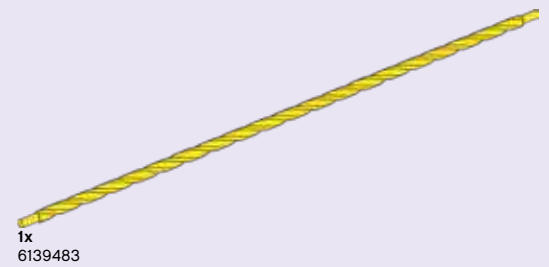

1x
6139483

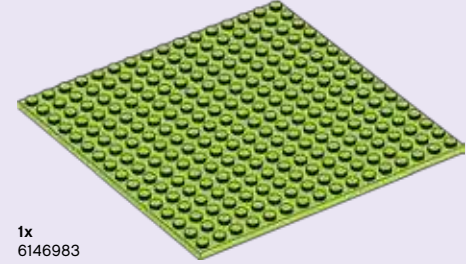

1x
6146983

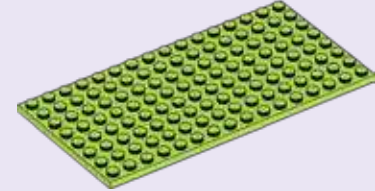

1x
6129600

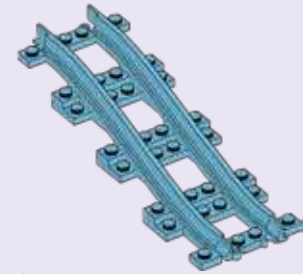

4x
6147028

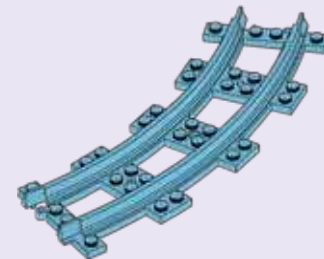

8x
6125658



Customer Service
Kundenservice
Service Consommateurs
Servicio Al Consumidor
LEGO.com/service or dial

00800 5346 5555 :



Friends



41128



41129



41130



■ 41130



■ 41129



■ 41128



■ 41127



41127



ELVES



41178



41180



41177



41179



41176



41175



41174



41173



41172



41171



Friends™



LEGO.com/friends



Google Play is a trademark of Google Inc. Apple, the Apple logo and iPad are trademarks of Apple Inc.

WIN

GO TO WWW.LEGO.COM/PRODUCTFEEDBACK AND
GIVE US YOUR SHORT **FEEDBACK** ABOUT THIS
LEGO® SET FOR A CHANCE TO WIN
A COOL LEGO PRIZE.

Terms & Conditions apply

LEGO.com/productfeedback

GEWINNE

Erzähle uns auf
www.LEGO.com/productfeedback

etwas über die Erfahrungen, die
du mit diesem LEGO® Set gemacht
hast, und sichere dir die Chance
auf einen coolen LEGO Preis!

Es gelten die
Teilnahmebedingungen

GAGNE

Rends-toi sur
www.LEGO.com/productfeedback

et donne-nous quelques com-
mentaires sur ce produit LEGO®
pour avoir une chance de gagner
un prix LEGO !

Voir Conditions Générales

GANAN

Visita
www.LEGO.com/productfeedback

y envíanos tu opinión acerca de
este set LEGO®. ¡Participarás en el
sorteo de un premio LEGO!

Términos y Condiciones aplicables

获取奖品

登录
www.LEGO.com/productfeedback

给出关于此乐高®套装的简短反馈，
就有机会获得炫酷乐高奖品

《条款及条件》适用

경품 당첨 기회

www.LEGO.com/productfeedback

페이지로 이동하여 이 레고® 세트에
대한 간략한 피드백을 보내 주시고
멋진 레고 경품을 탈 수 있는 기회도
잡으십시오

약관 적용

ЗАПОЛНИ АНКЕТУ И ПОЛУЧИ ПРИЗ

Перейди по ссылке
www.LEGO.com/productfeedback

ответь всего на несколько во-
просов об этом наборе LEGO®,
и у тебя появится шанс выиграть
замечательный приз от компании
LEGO.

Применяются Условия и правила
участия