



CREATOR

10253



LEGO.com/creator



© Shutterstock.com

 The tower is commonly known as Big Ben, but was named Elizabeth Tower in celebration of the Queen's Diamond Jubilee in 2012.

Of the five bells in Elizabeth tower, only the largest is called Big Ben.

The bell is wider than it is tall, so it had to be raised up sideways in the tower during installation.

The 300 statues that make up the facade of the building represent saints and sovereigns dating from the Norman conquest to the reign of Queen Victoria.

 La tour est généralement connue sous le nom de Big Ben, mais fut appelée Tour Elizabeth lors de la célébration du Jubilé de la Reine en 2012.

Des cinq cloches de la Tour Elizabeth, seule la plus grande est appelée Big Ben.

La cloche est plus large que haute, elle a donc dû être installée dans la tour en étant soulevée de côté.

Les 300 statues présentes sur la façade du bâtiment représentent les saints et les souverains depuis la conquête normande jusqu'au règne de la Reine Victoria.

 A torre é geralmente conhecida por Big Ben, mas recebeu o nome de Torre Elizabeth por altura da celebração do Jubileu de Diamante da Rainha em 2012.

Dos cinco sinos na torre Elizabeth, só o maior é chamado Big Ben.

O sino apresenta uma largura superior à altura, por isso teve de ser elevado lateralmente durante a sua instalação.

As 300 estátuas que compõem a fachada do edifício representam santos e soberanos da época da conquista normanda no reinado da Rainha Victoria.

 Der Turm ist allgemein als Big Ben bekannt, doch er wurde im Jahr 2012 zu Ehren des diamantenen Thronjubiläums der Königin „Elizabeth Tower“ getauft.

Von den fünf Glocken im Elizabeth Tower trägt lediglich die größte den Namen Big Ben.

Die Glocke ist breiter als hoch, wodurch sie bei ihrer Installation im Turm seitwärts nach oben transportiert werden musste.

Die 300 Statuen, aus denen die Fassade des Gebäudes besteht, zeigen Heilige und Herrscher aus der Zeit der normannischen Eroberung bis hin zur Herrschaft von Königin Victoria.

 La torre suele conocerse como “el Big Ben”; sin embargo, fue bautizada como “Torre de Isabel” en 2012 para celebrar el jubileo de diamante de la reina.

De las cinco campanas de la Torre de Isabel, sólo la más grande se denomina Big Ben.

La campana es más ancha que alta, por lo que fue necesario izarla de lado por la torre para instalarla.

Las 300 estatuas que decoran la fachada del edificio representan a santos y soberanos de épocas comprendidas entre la conquista normanda y el reinado de la reina Victoria.

 A tornyot Big Ben néven ismerik világszerte, de a királynő gyémántjubiléuma, 2012 óta Erzsébet-toronynak nevezik.

Az Erzsébet-toronyban elhelyezett öt harang közül csak a legnagyobbak a neve Big Ben.

A harang szélessége nagyobb, mint a magassága, ezért oldalára döntve emelték be a toronyba, amikor beépítették.

Az épület homlokzatát 300 szobor teszi teljessé, amelyek szenteket és a normann hódítás korától Viktória királynő koráig élt uralkodókat ábrázolnak.

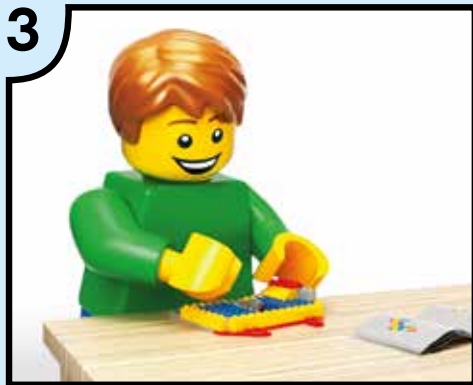

LEGO.com/brickseparator

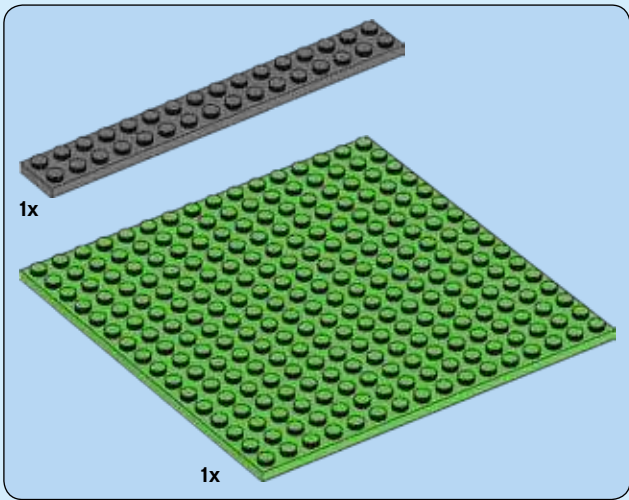
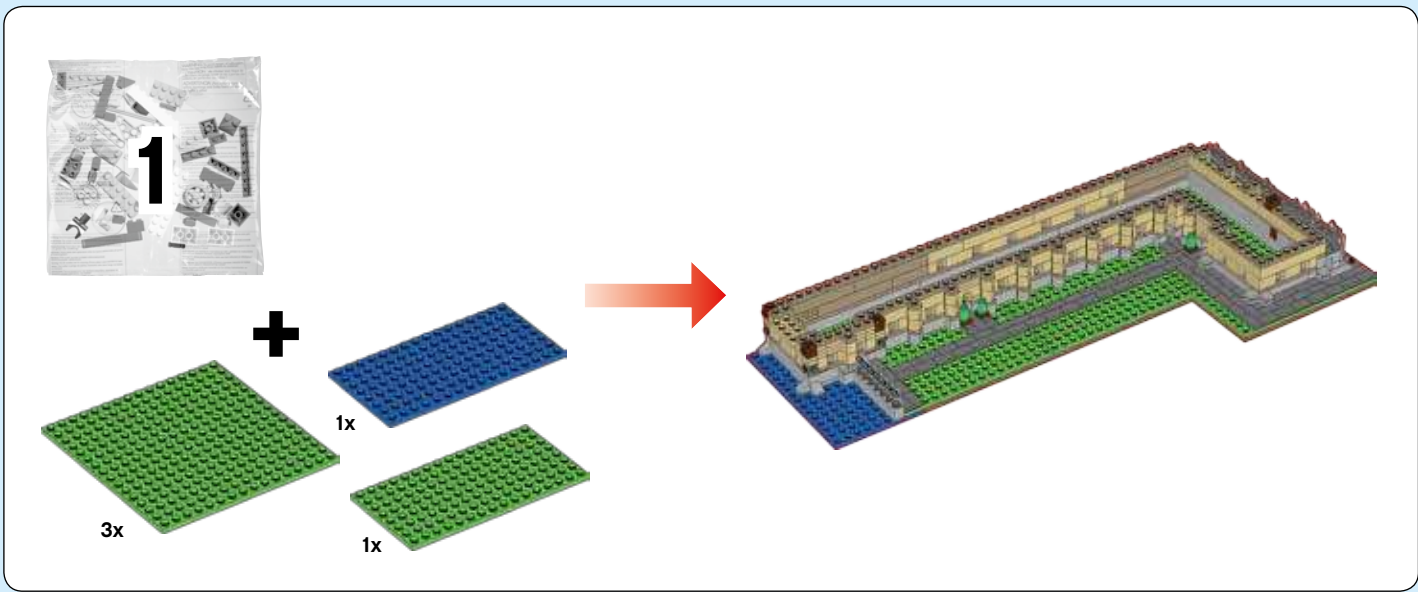

1

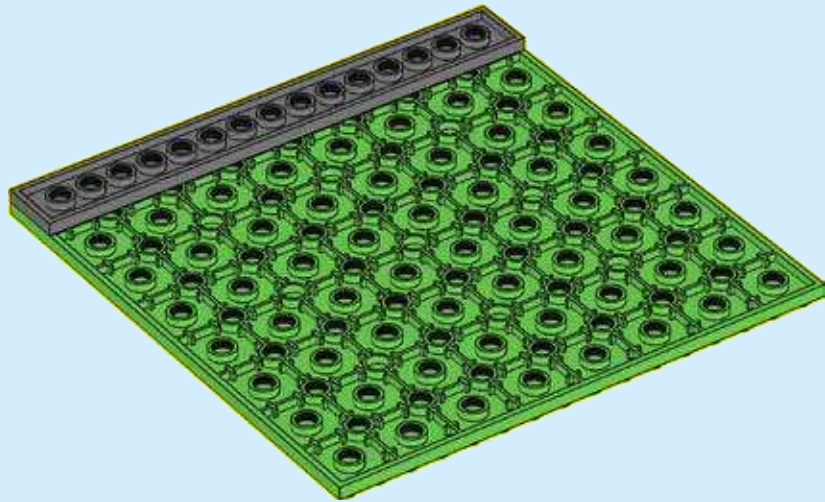

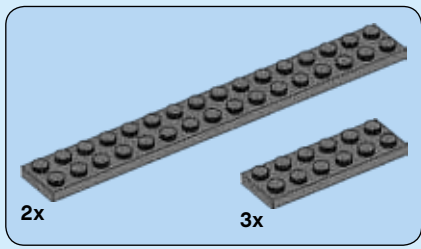

2

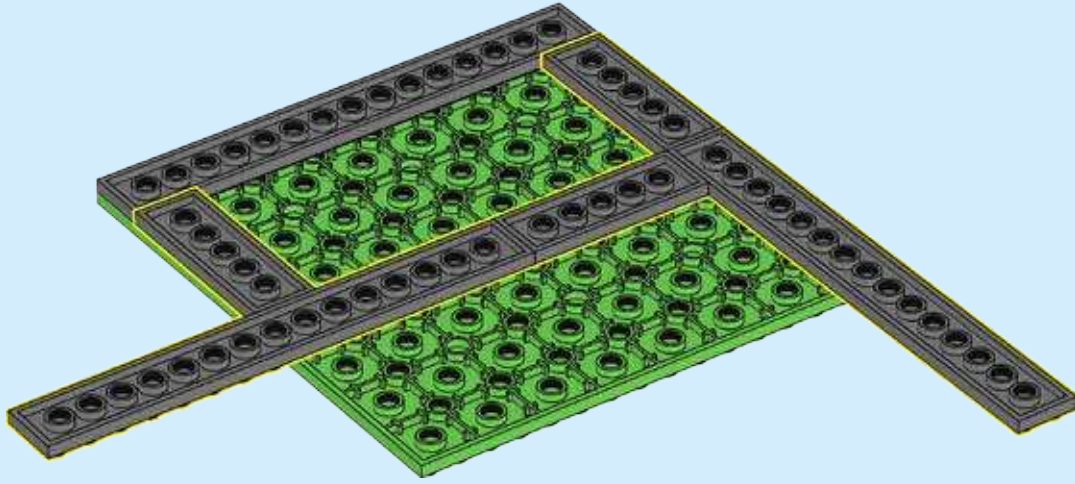

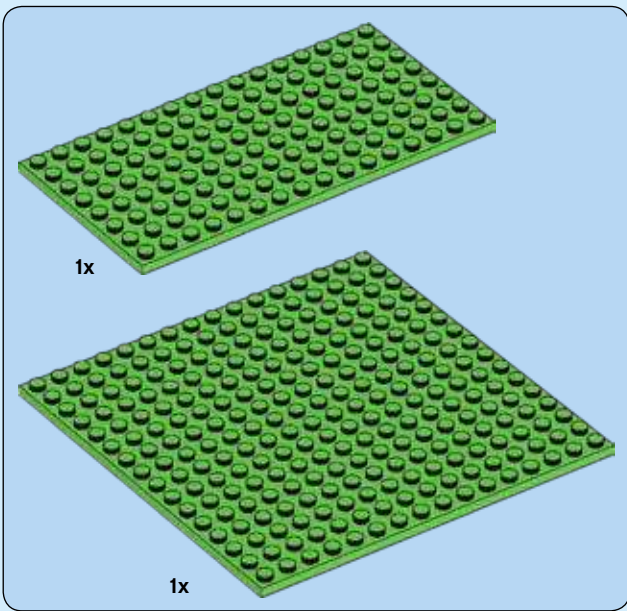

3

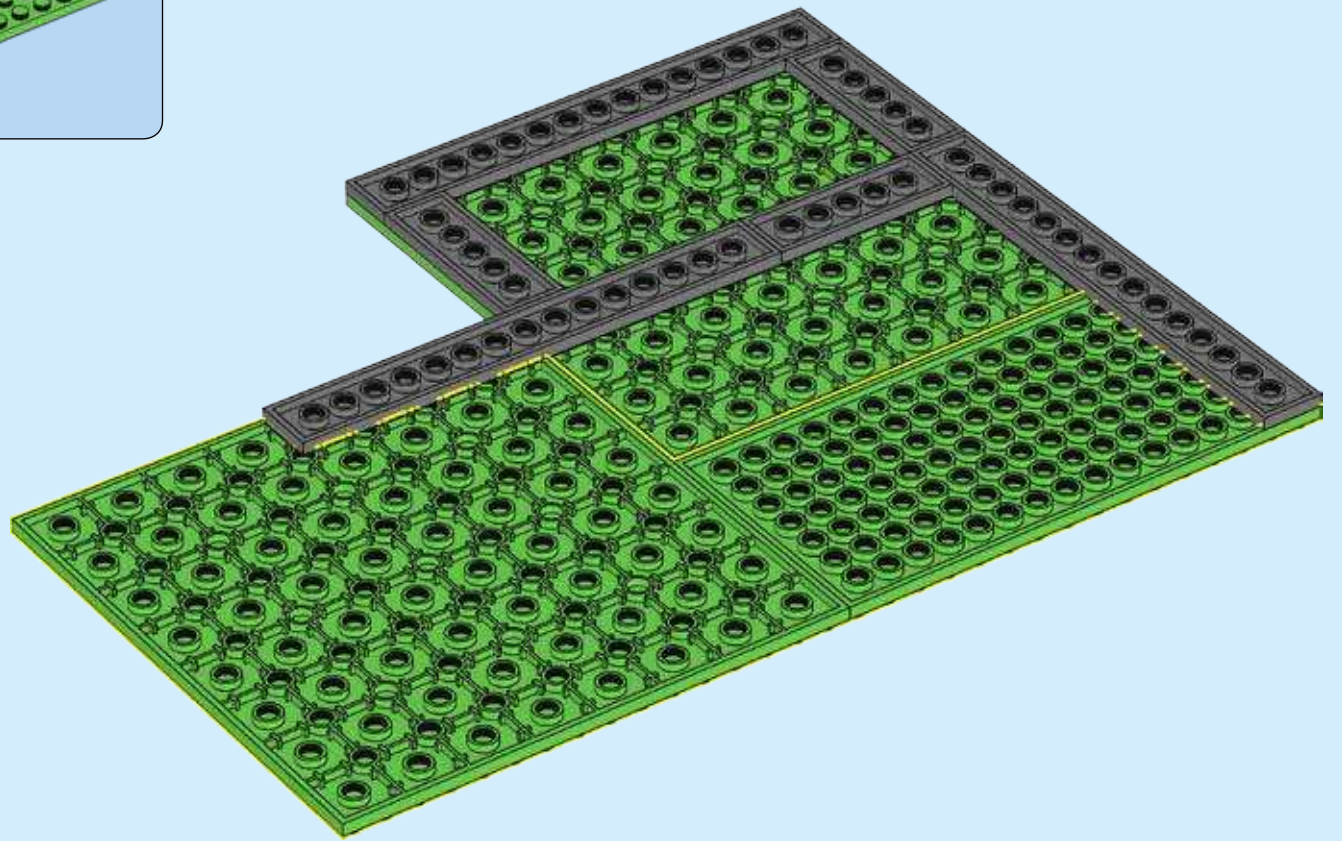

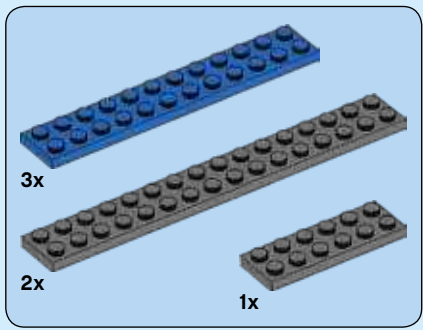

4

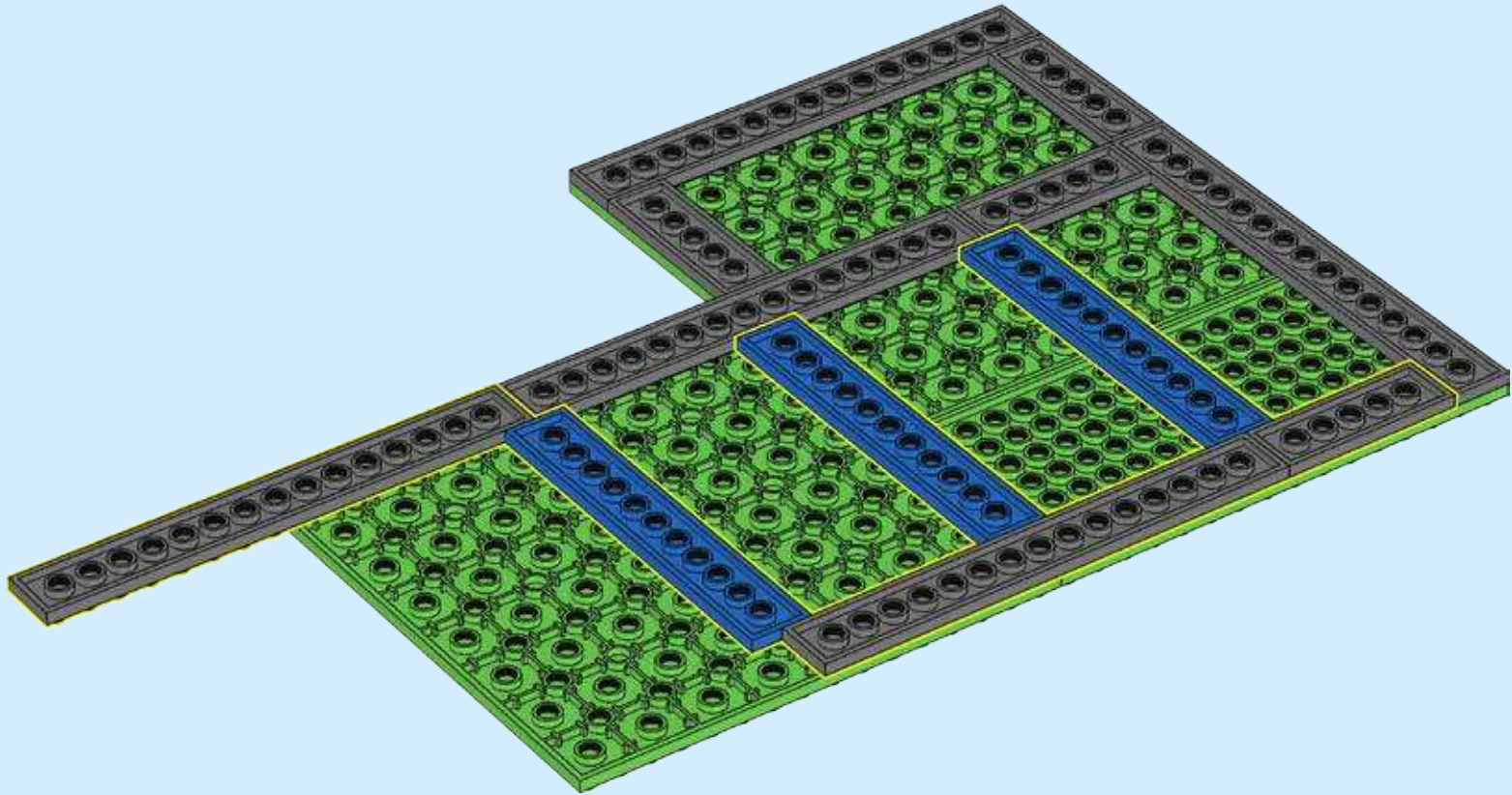

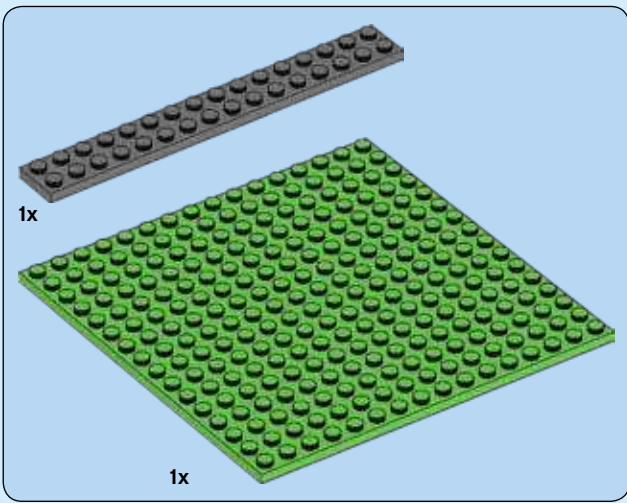

5

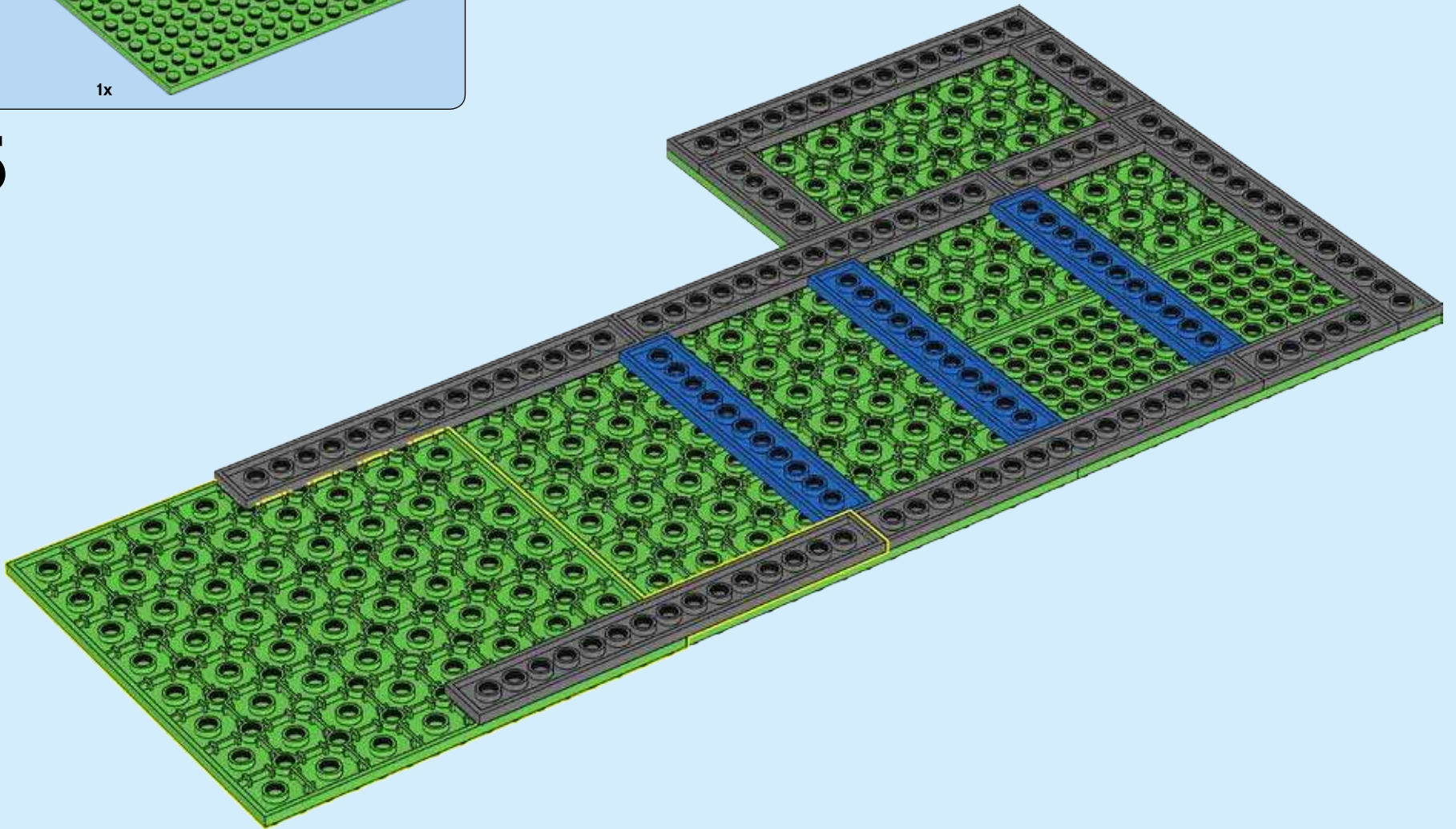

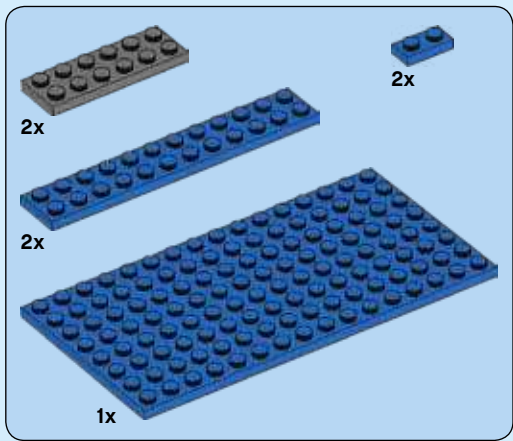

6

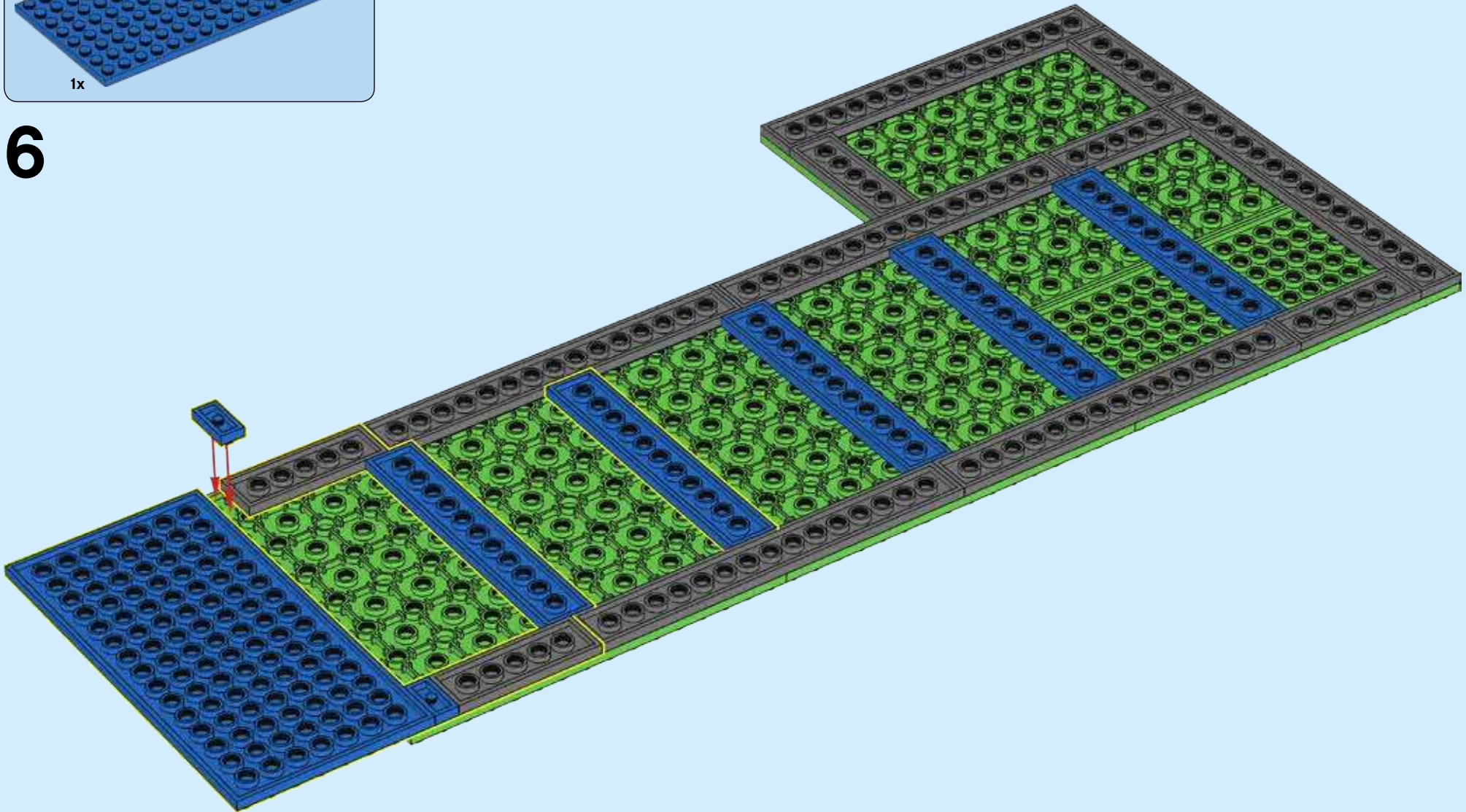

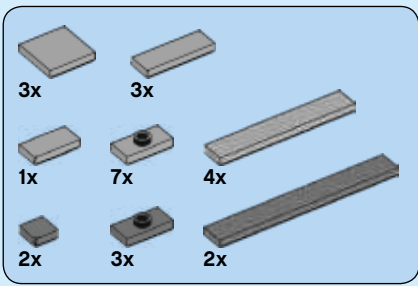

7

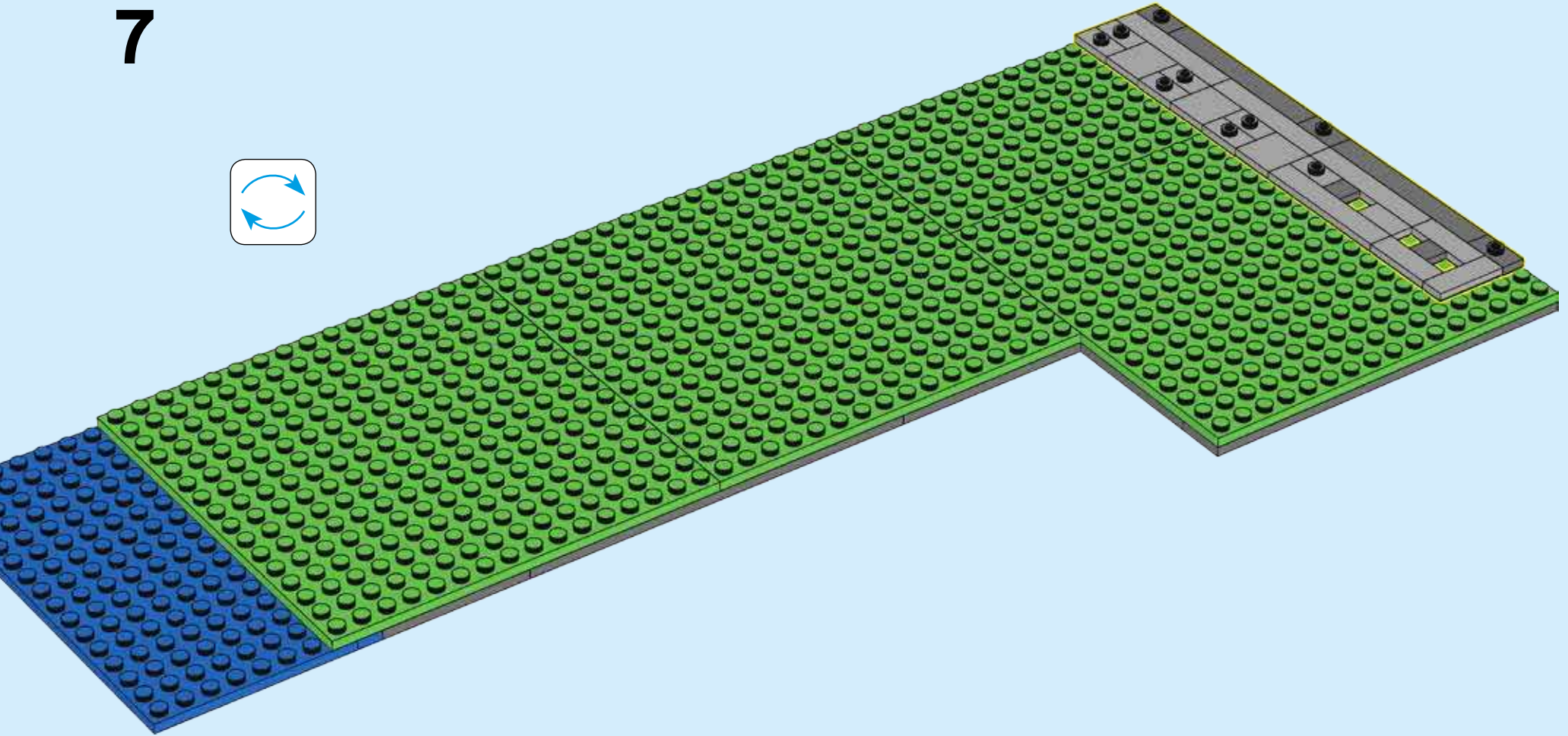

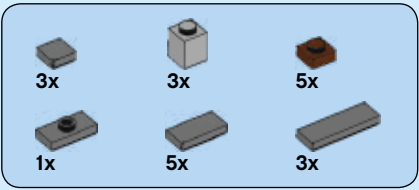

8

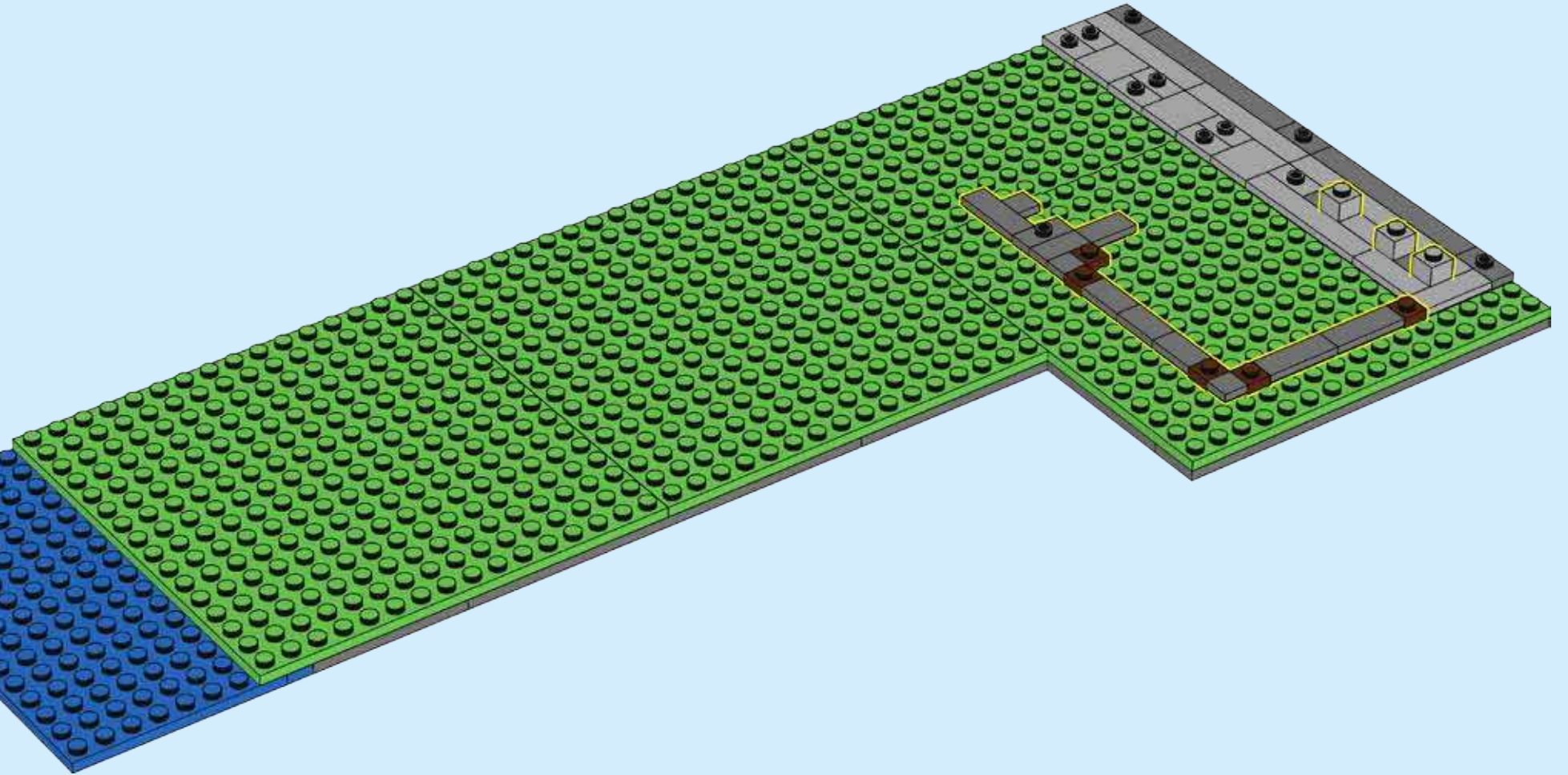

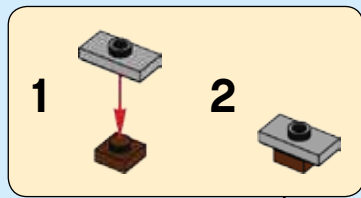
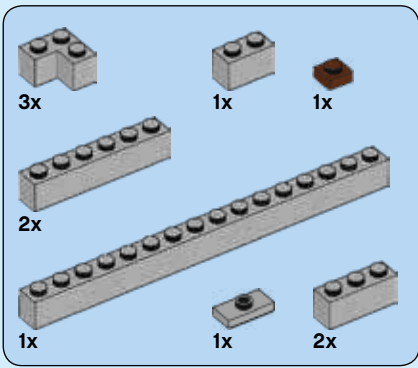

9

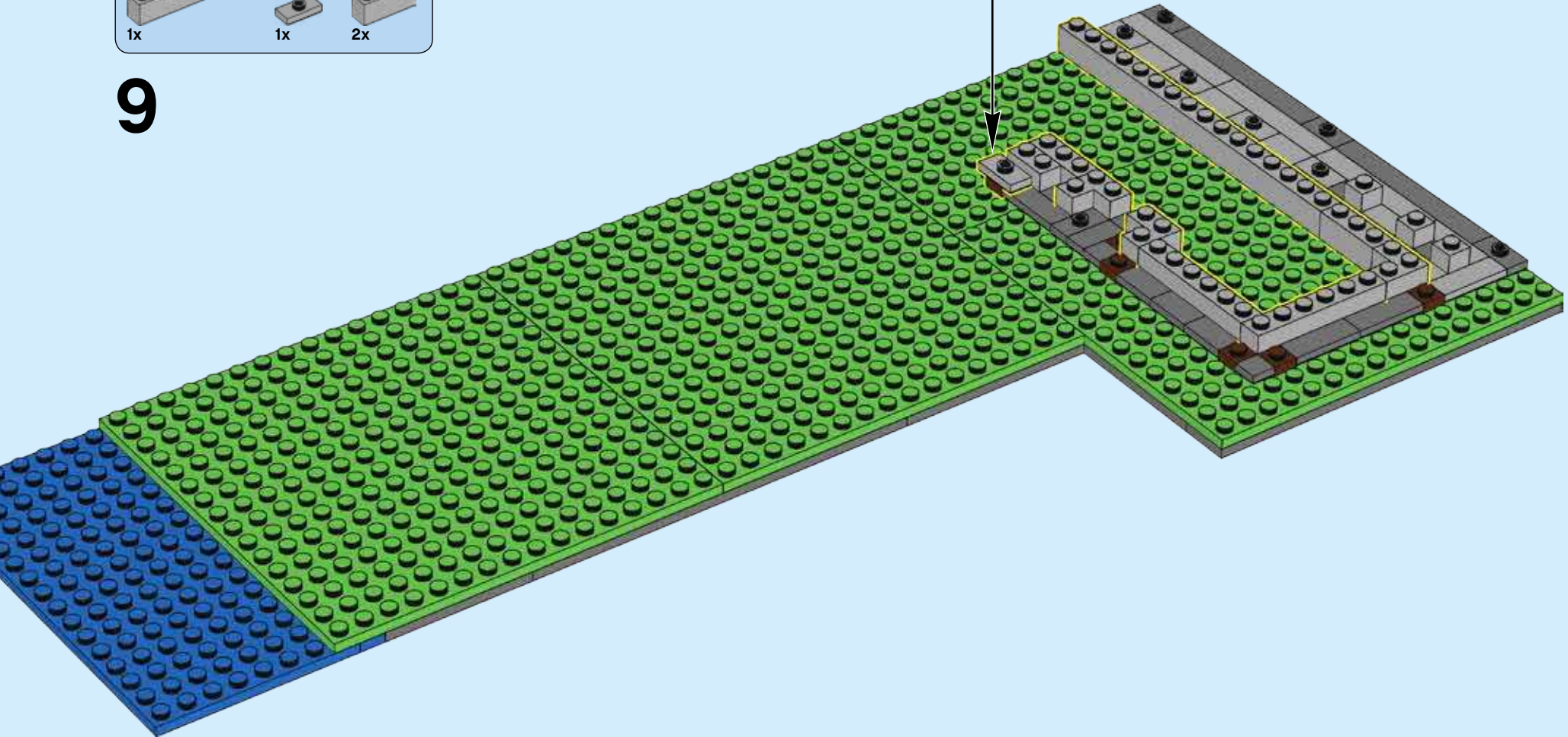

27x 5x 1x

10

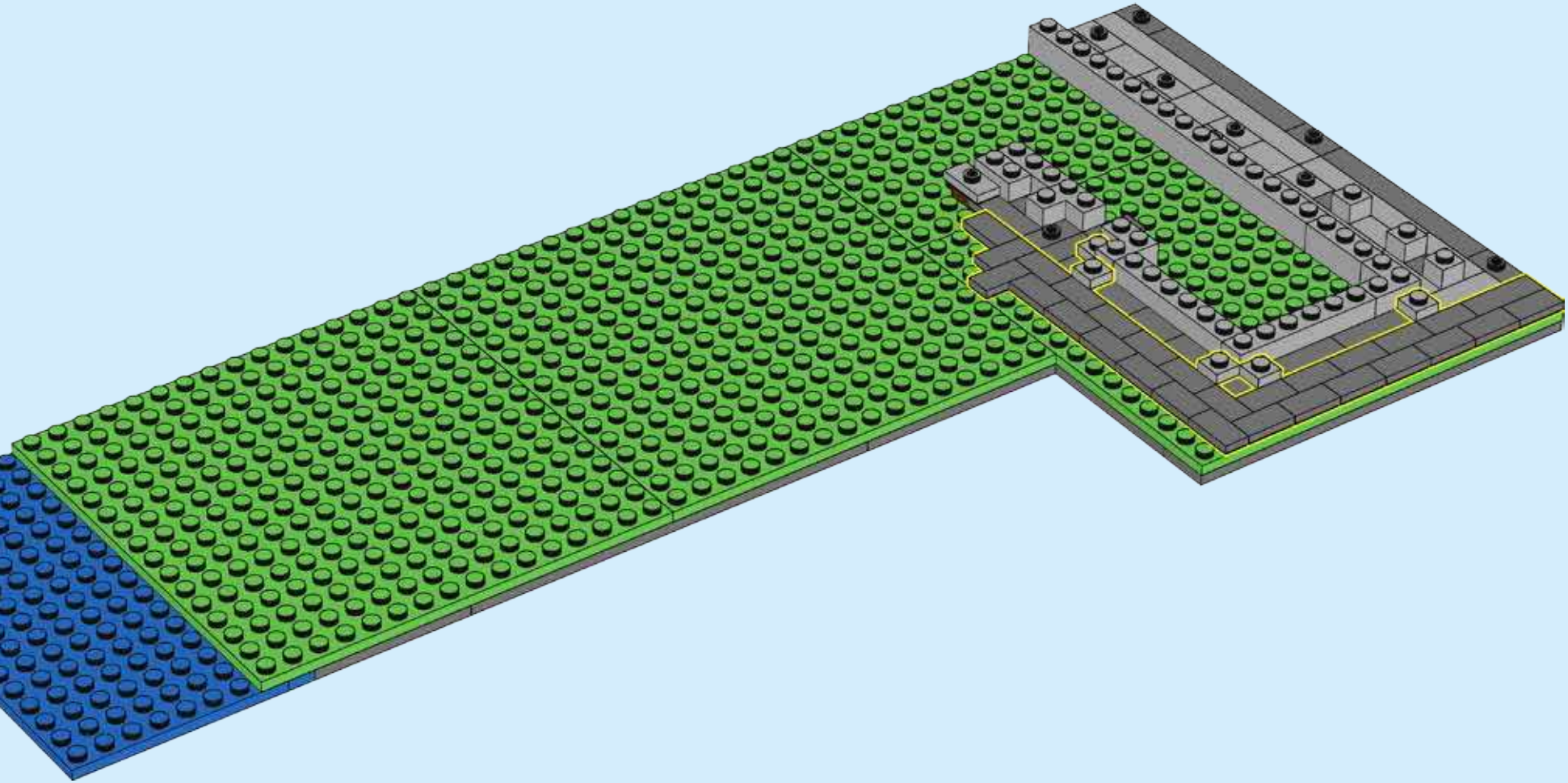

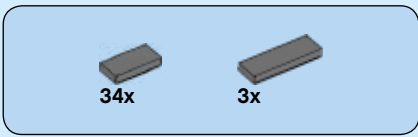

11

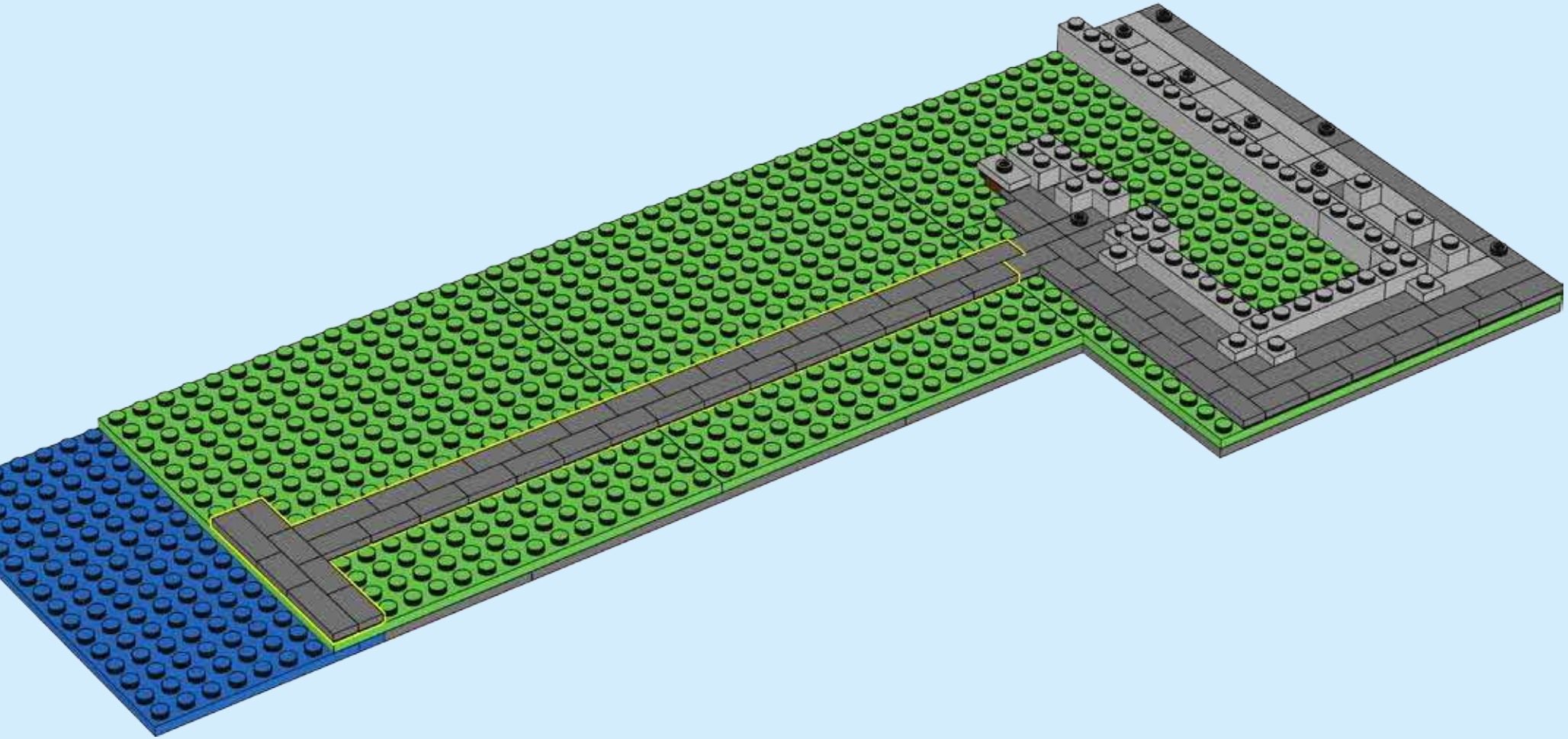

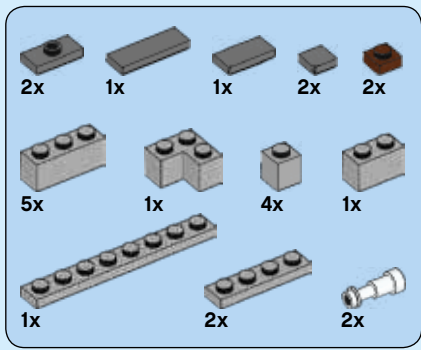

12

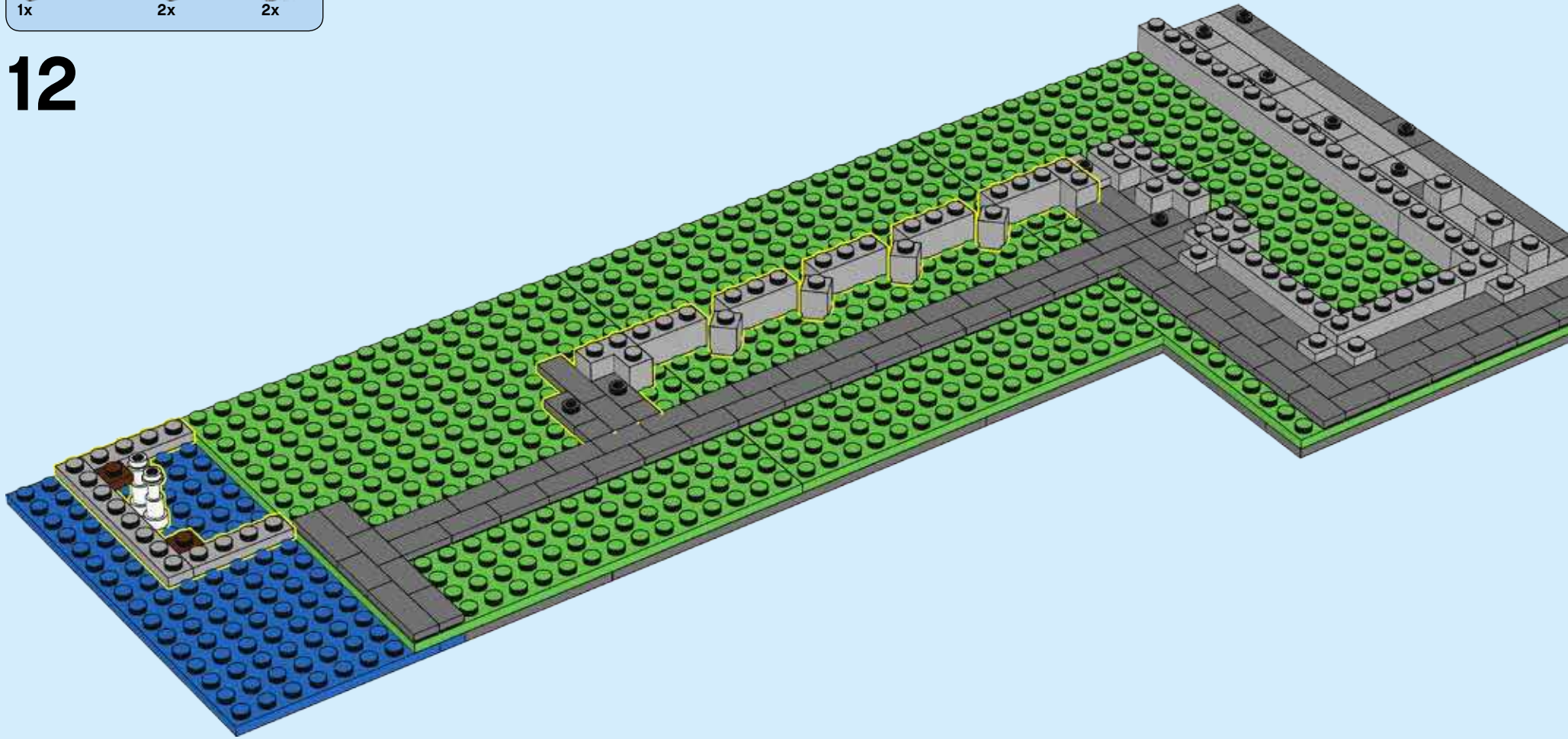

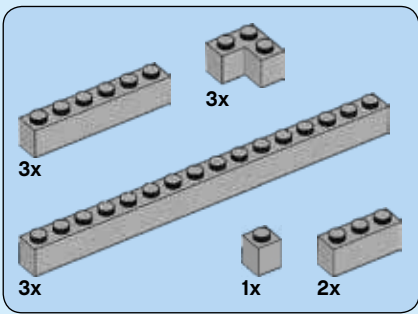

13

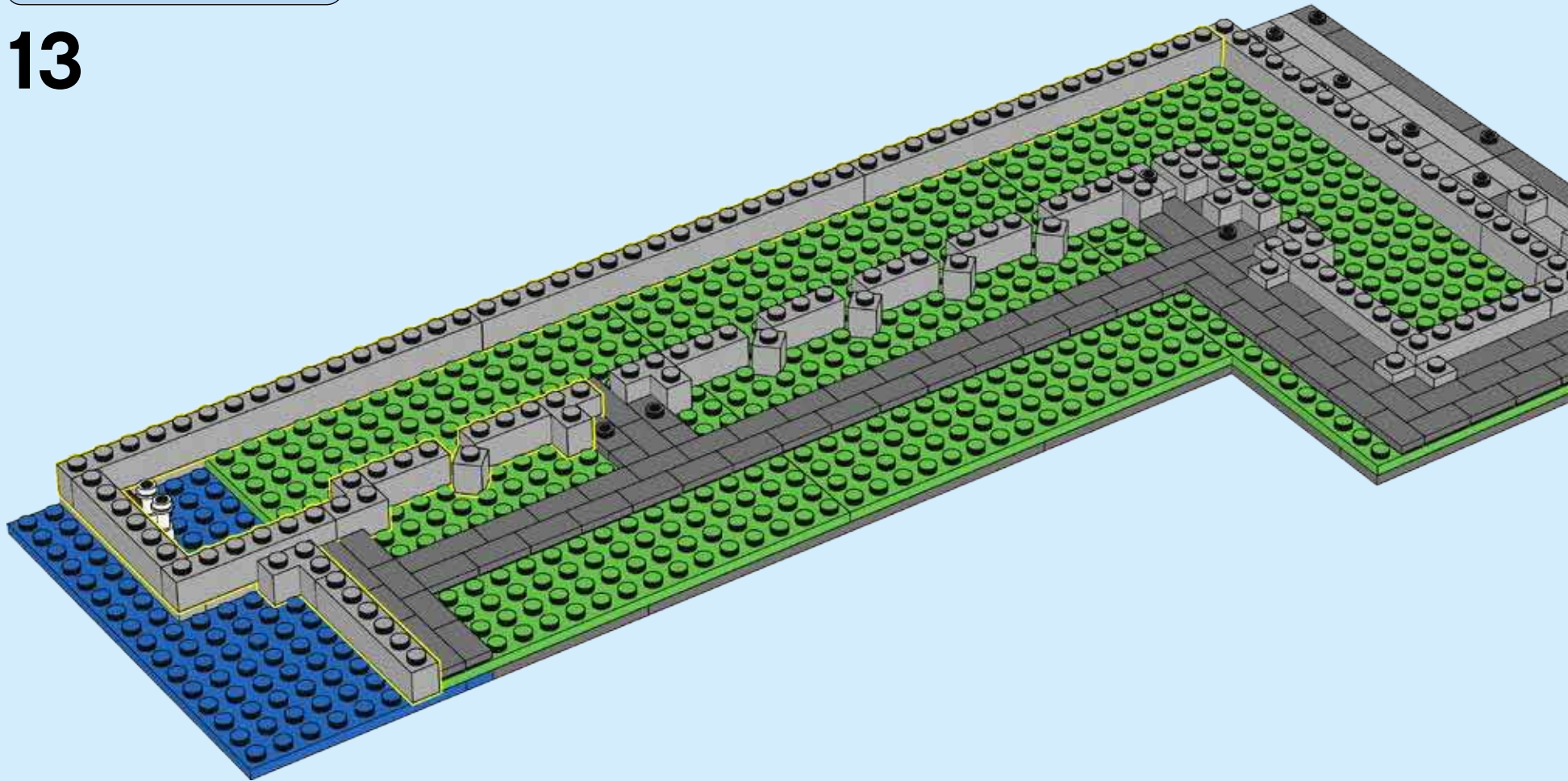

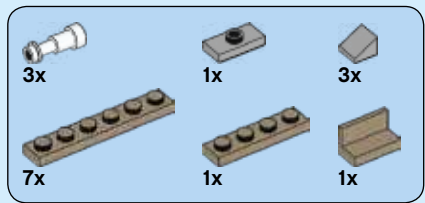

14

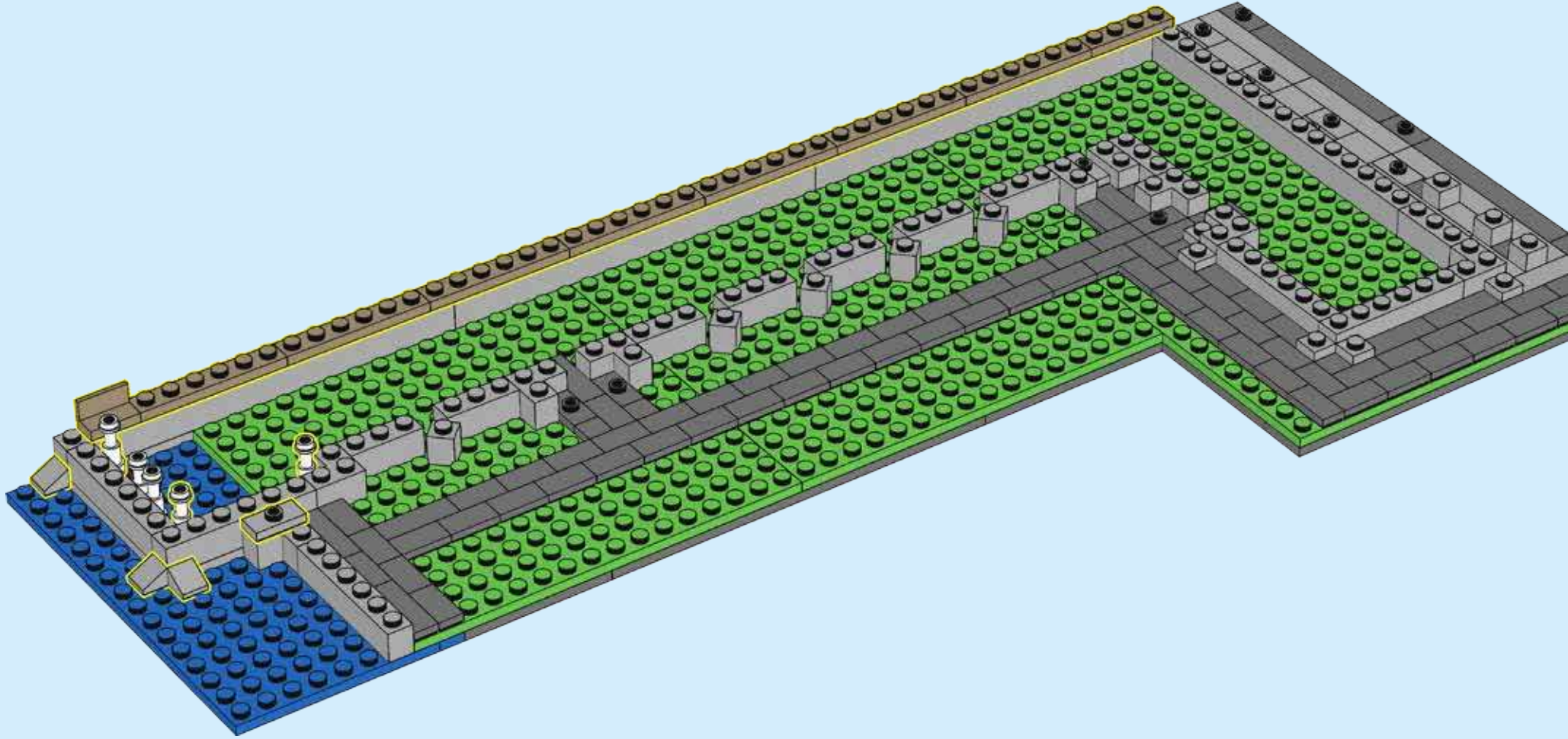



15

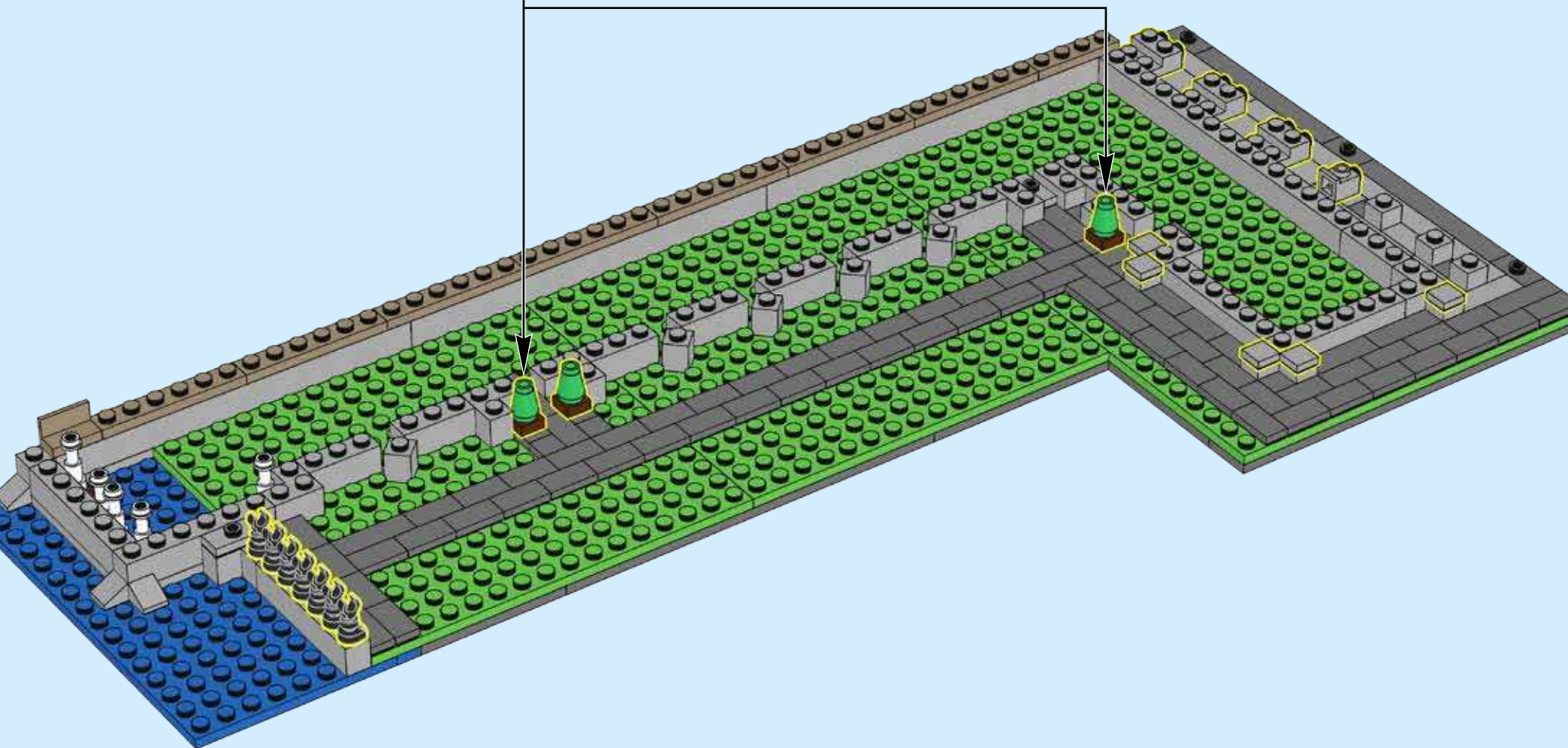

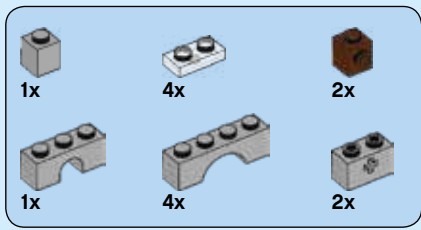

16

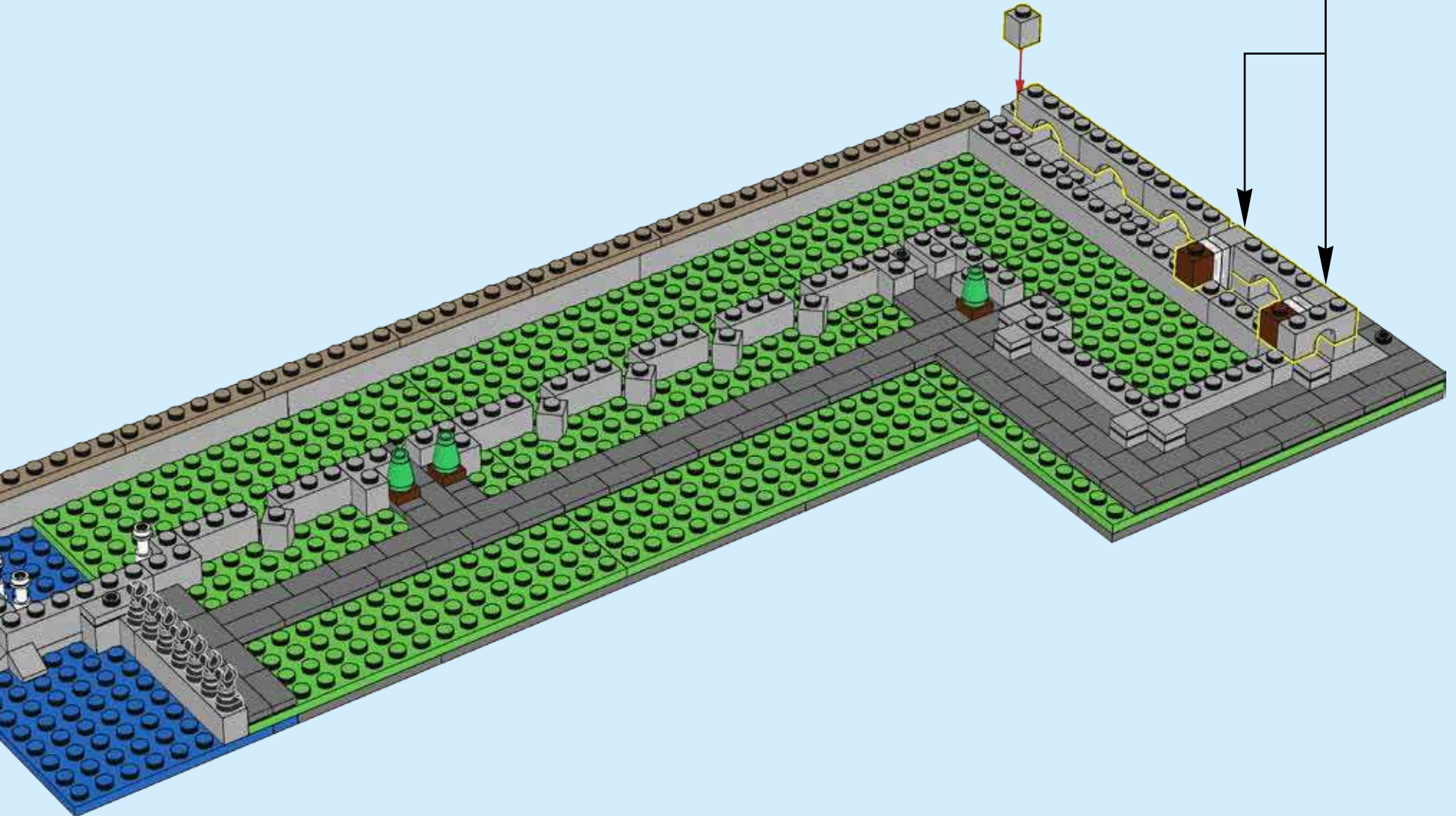
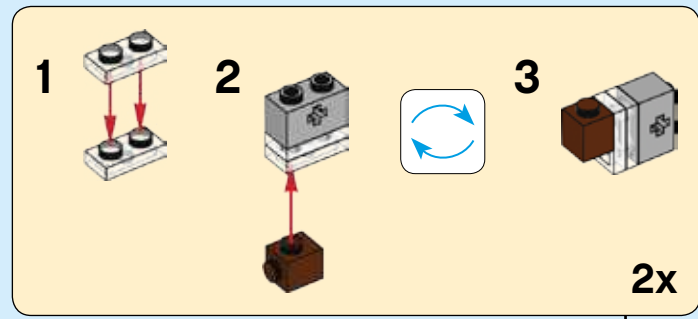

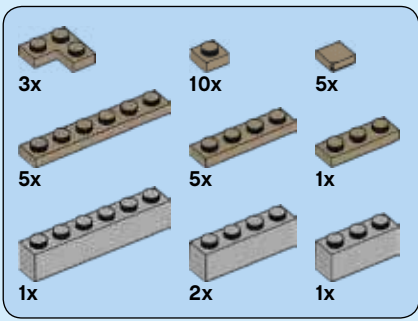

17

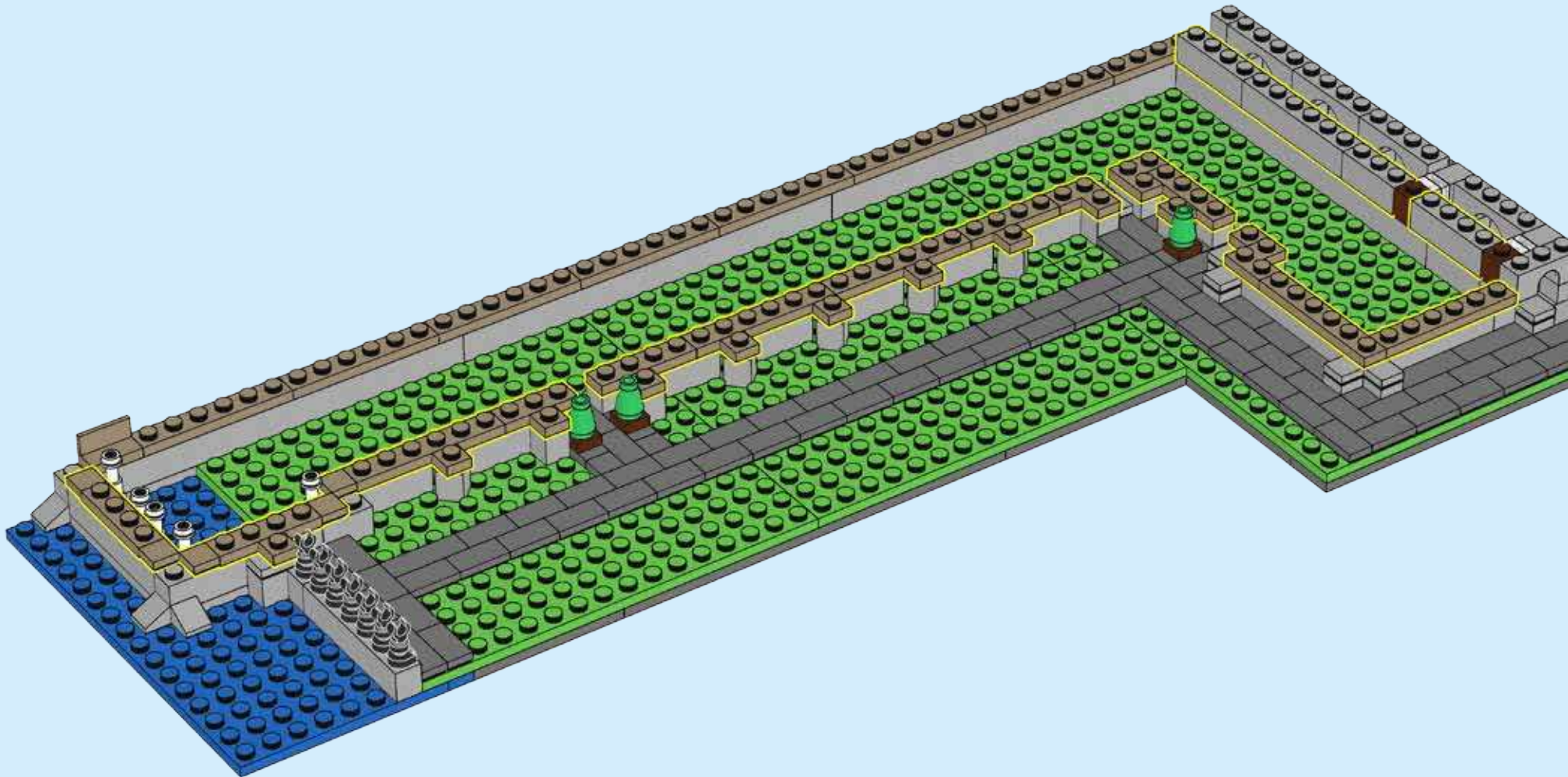

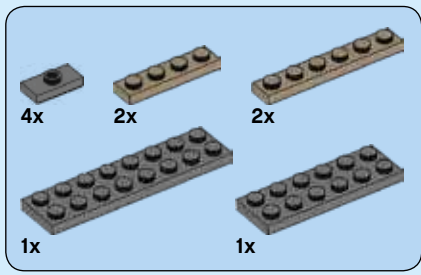

18

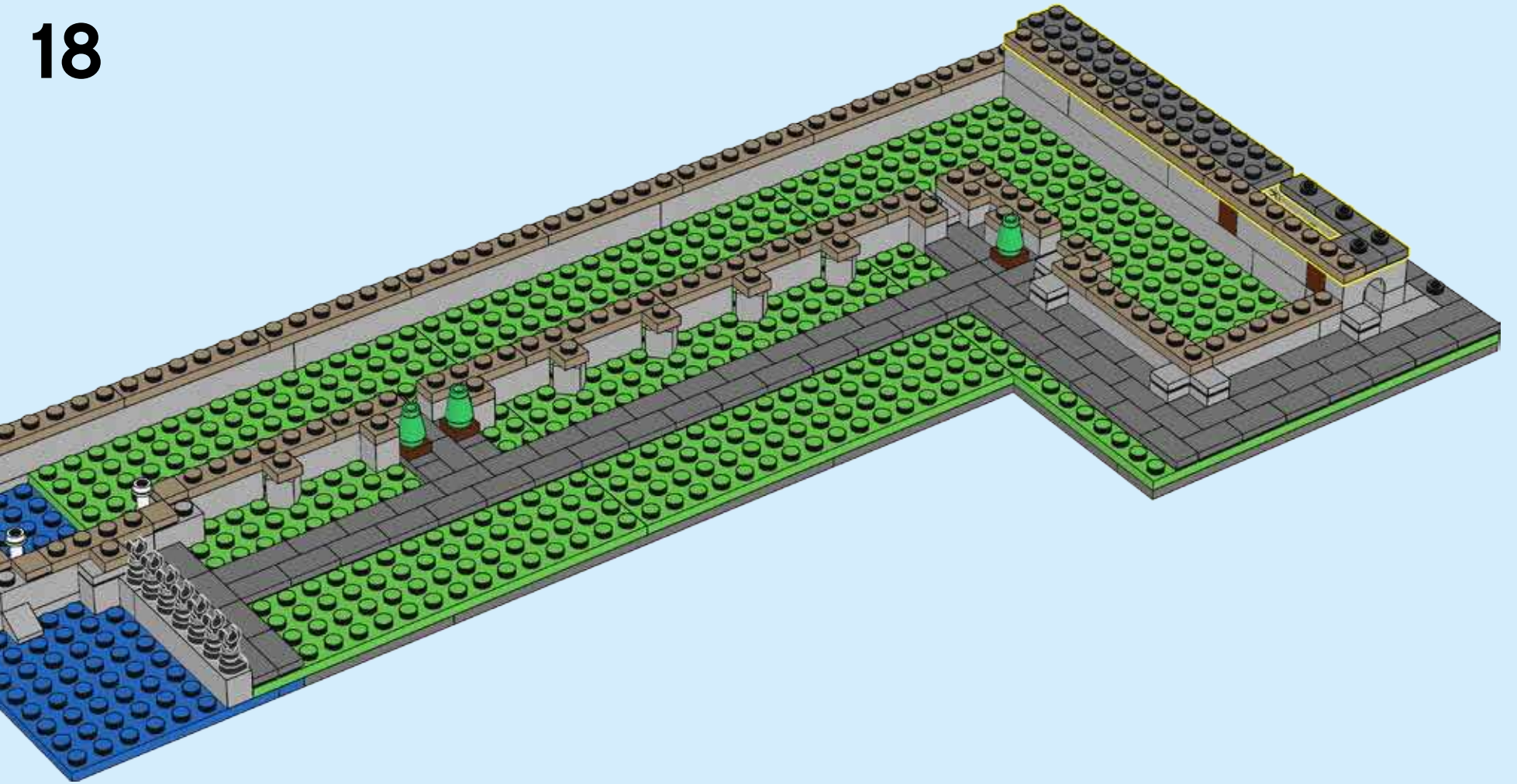

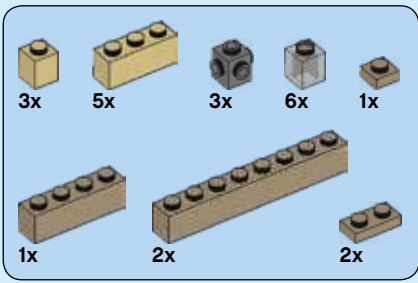

19

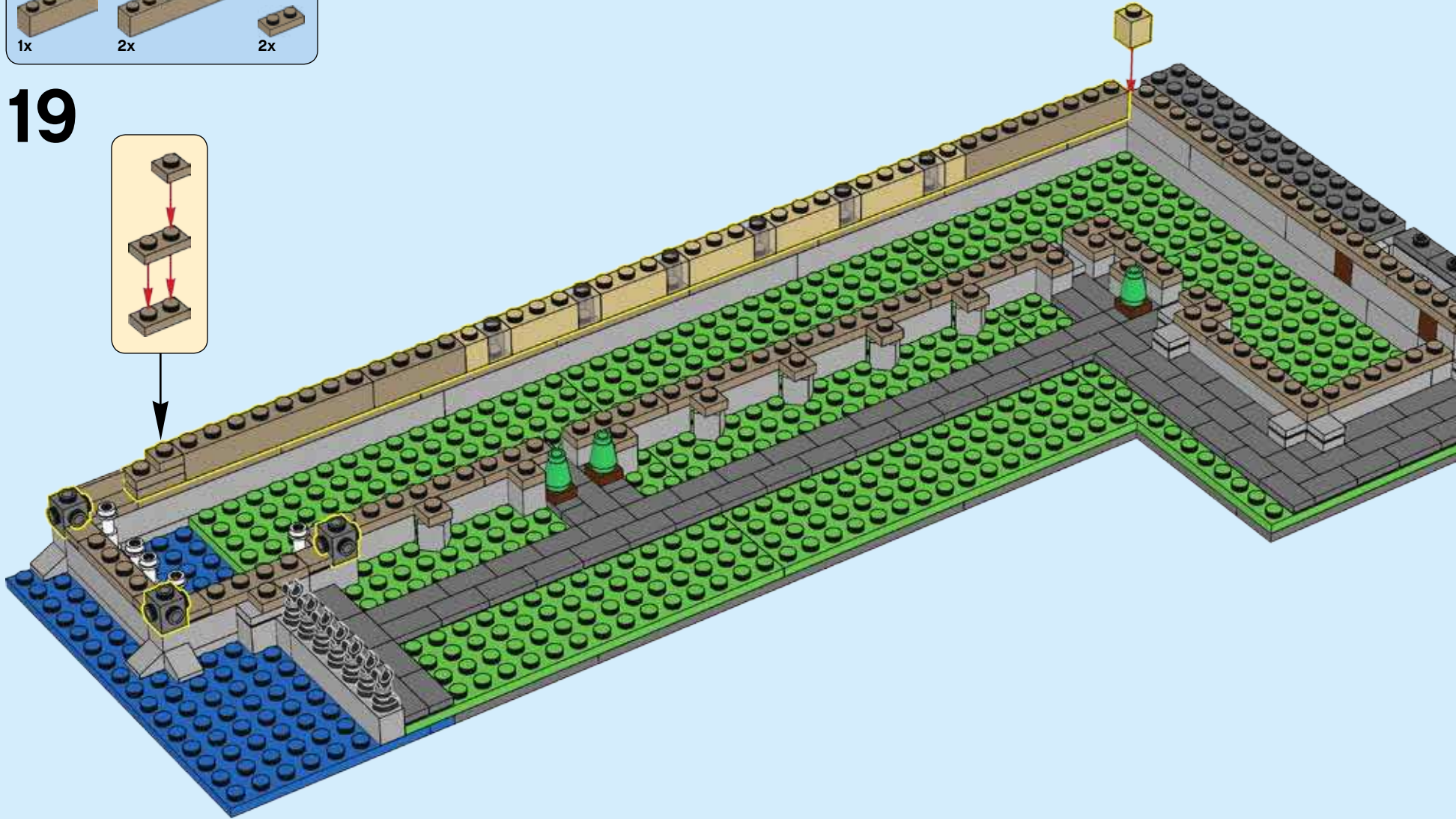
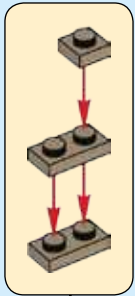

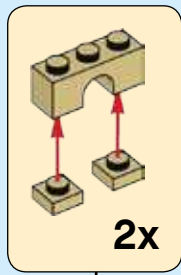
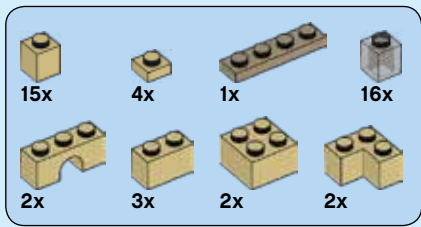

20

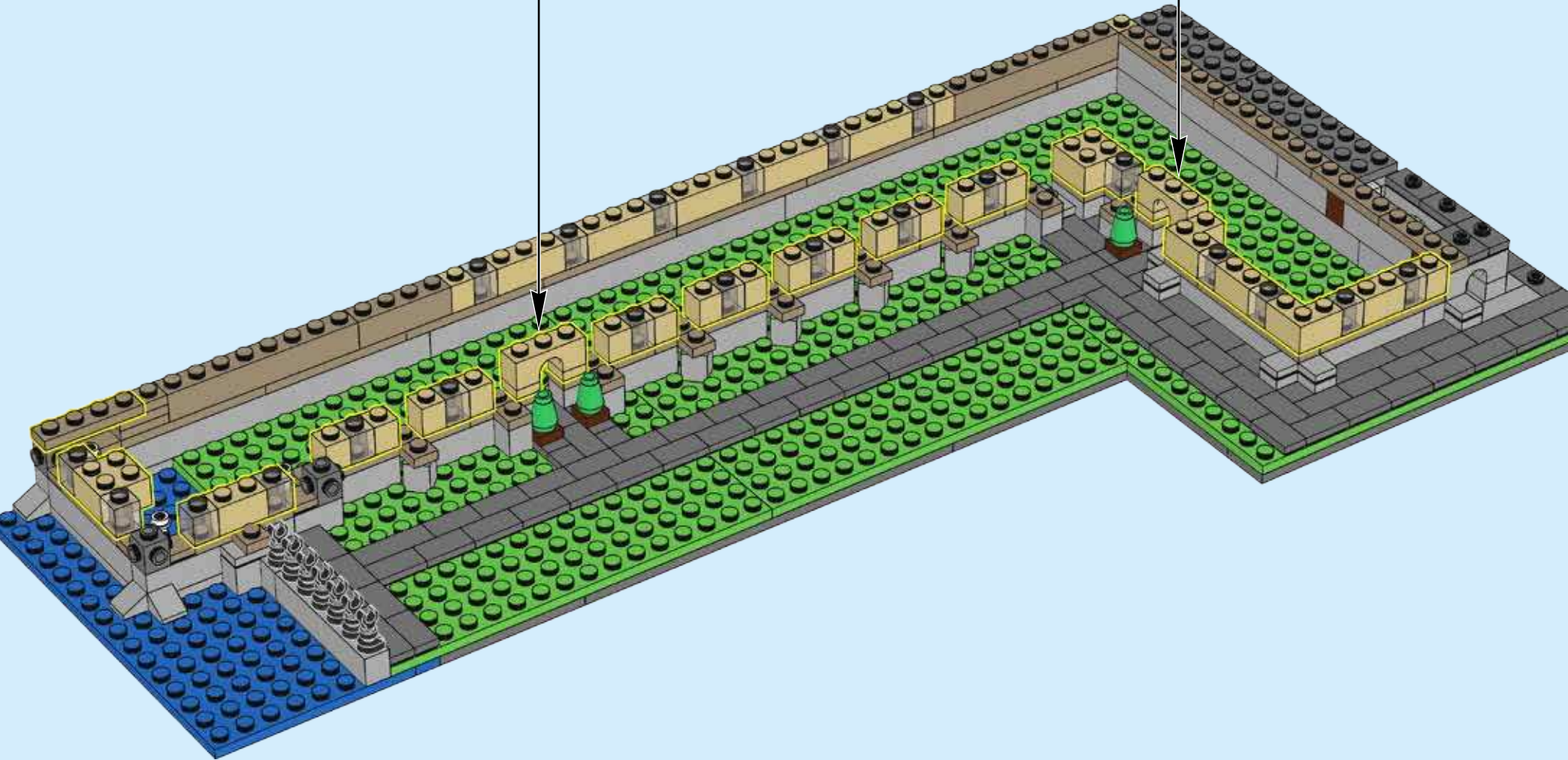

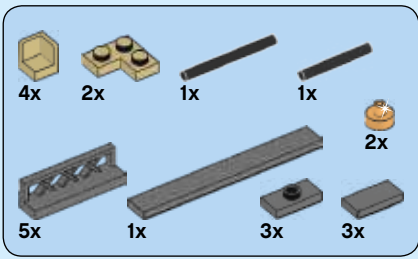

21

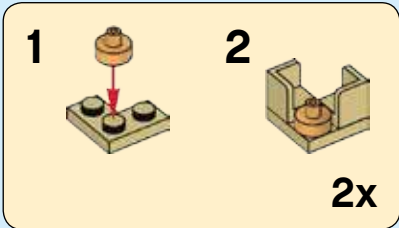

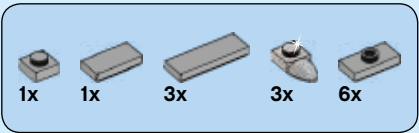

22

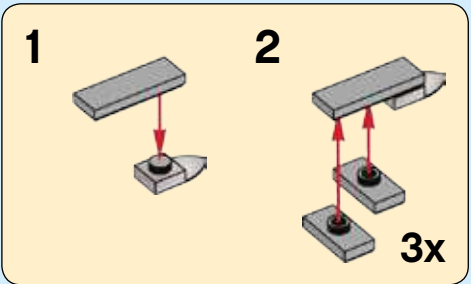

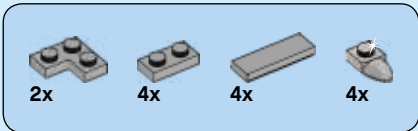

23

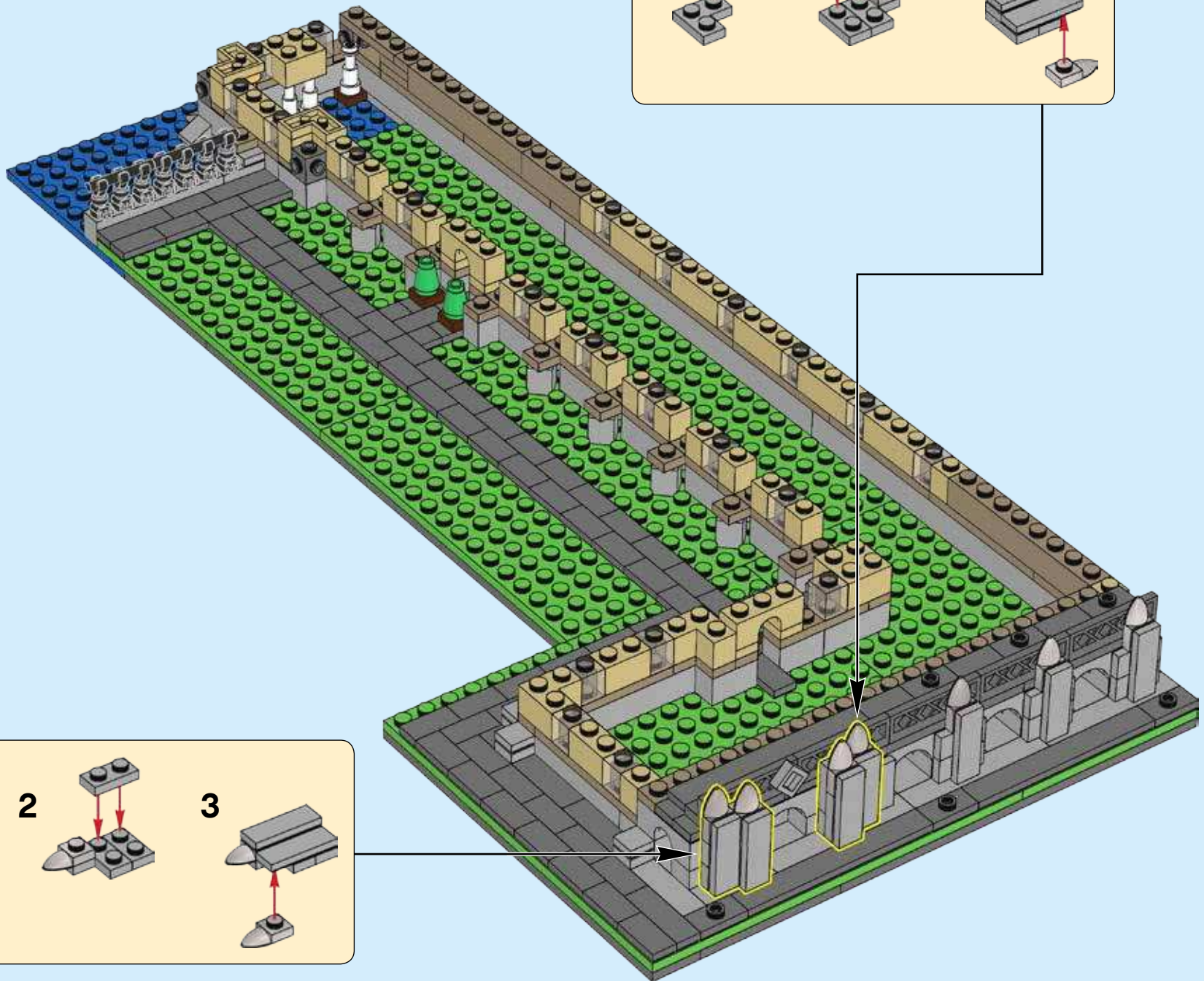
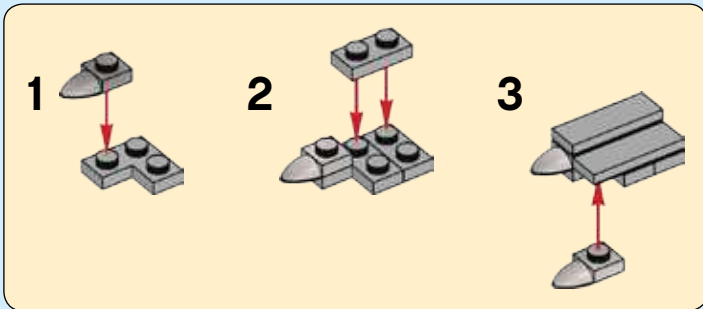
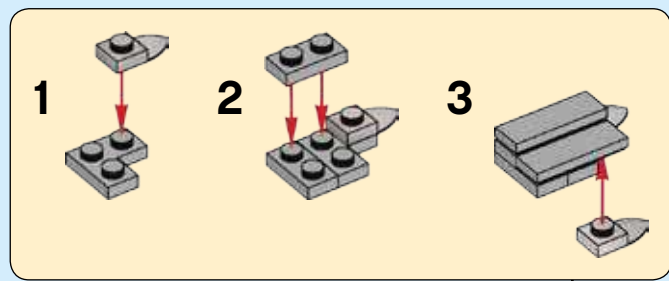

1x 2x 11x

24



5x

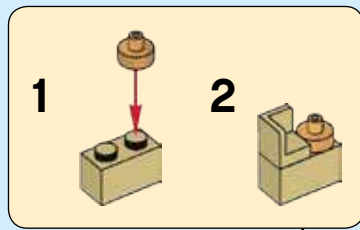
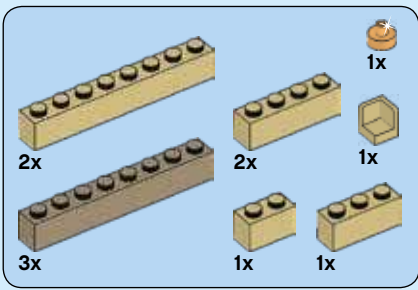

25

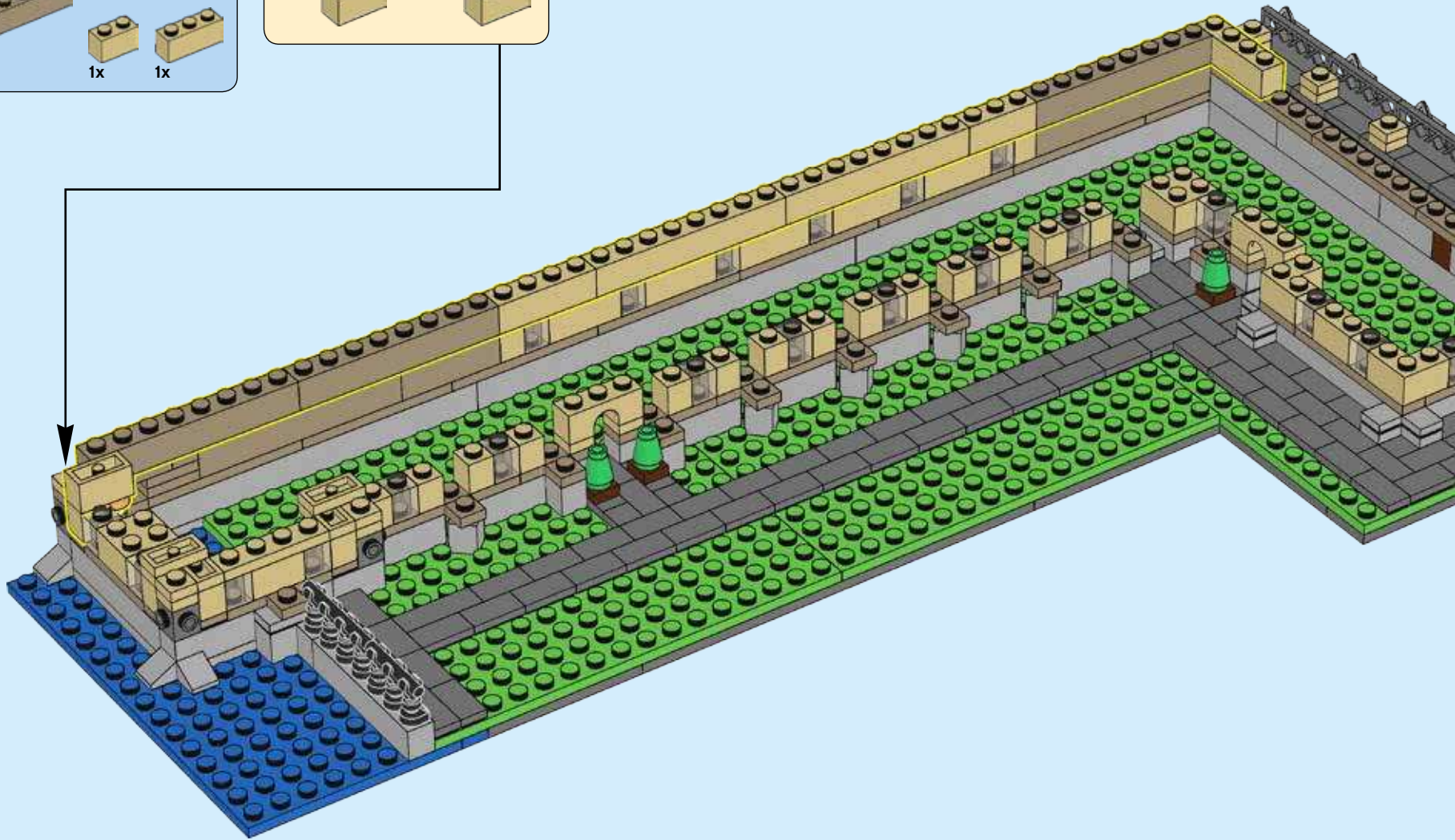

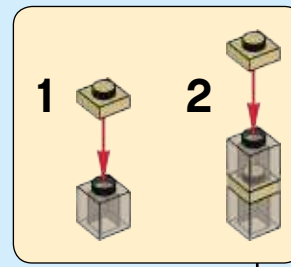
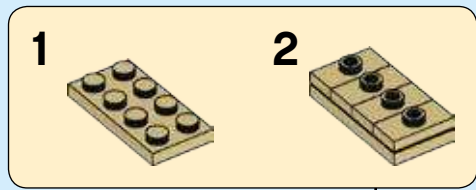
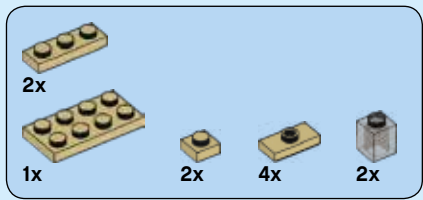

26



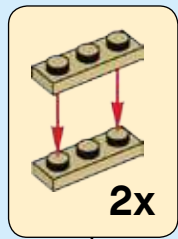
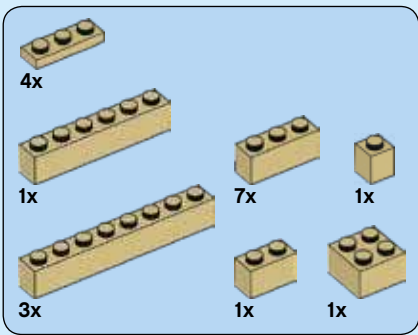

27



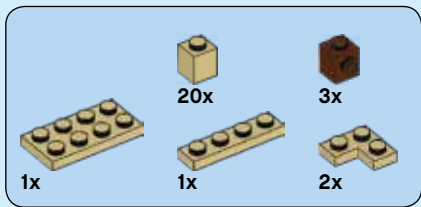

28

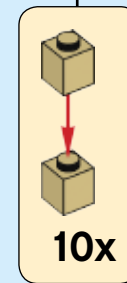
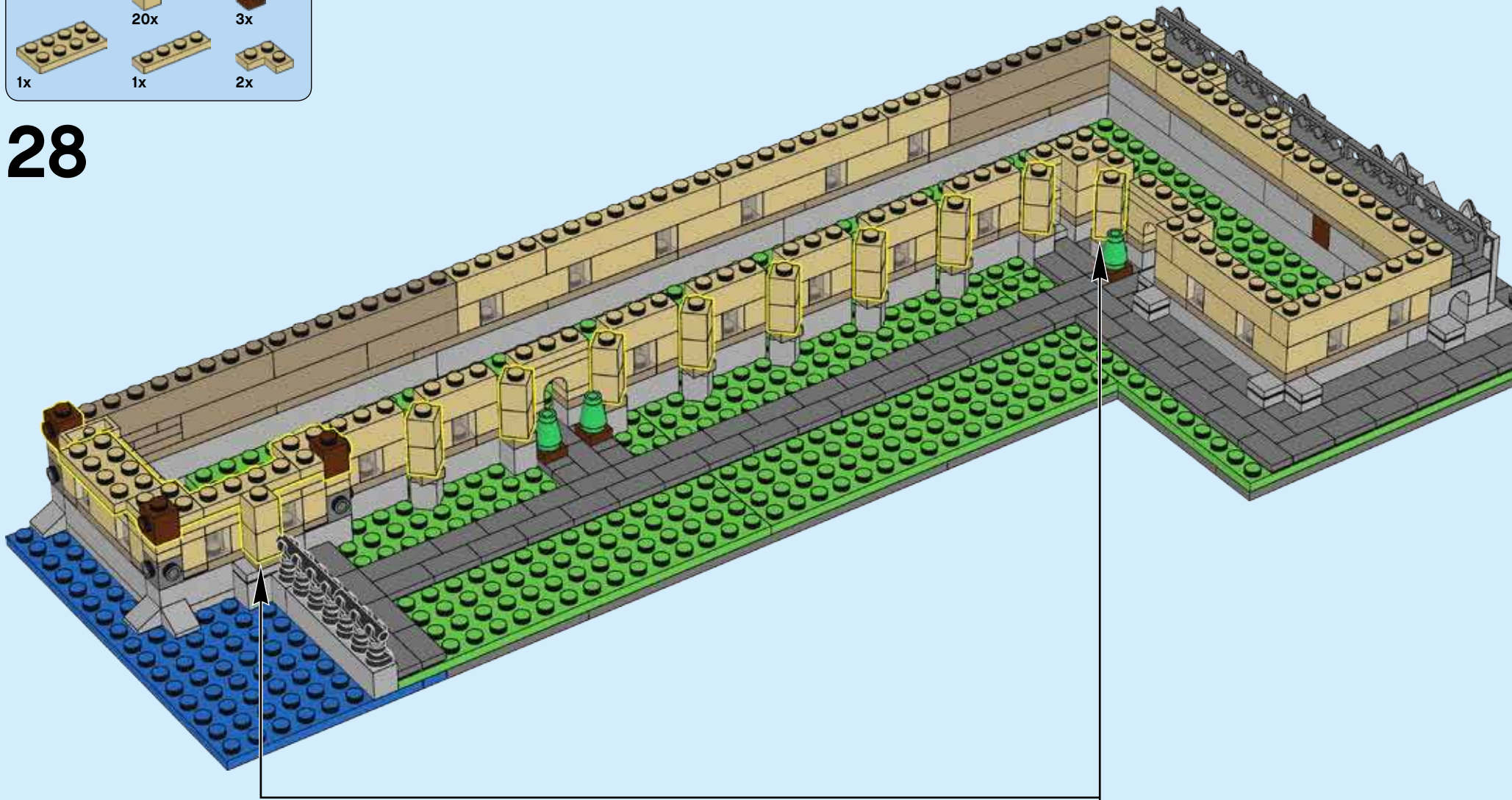

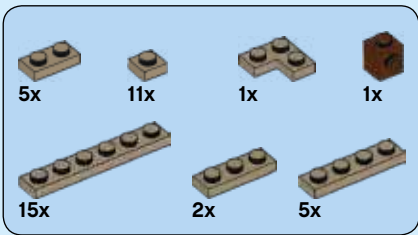

29



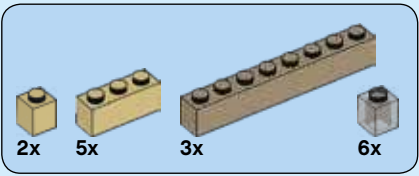
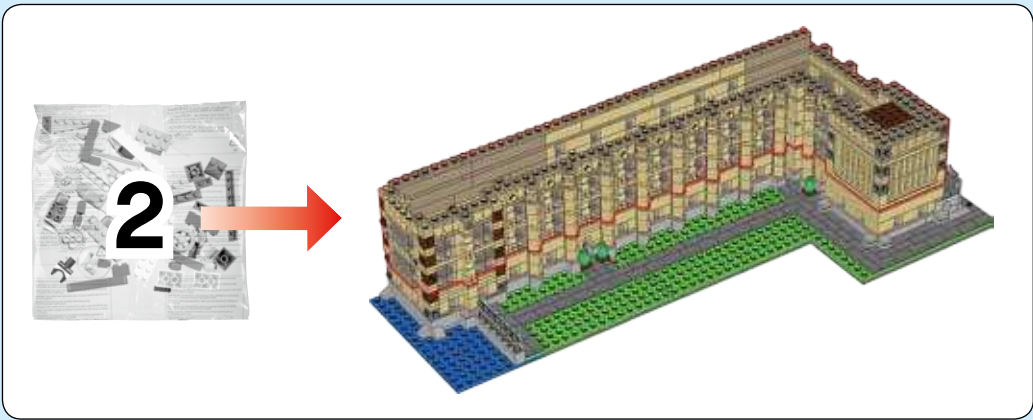

30



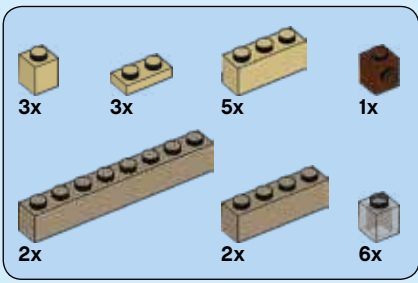

31

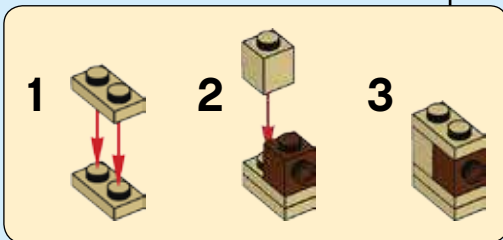

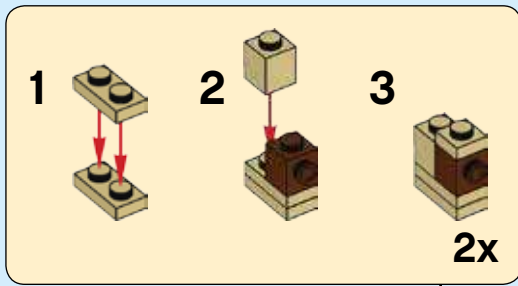
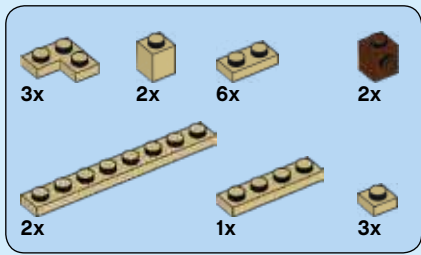

32





33

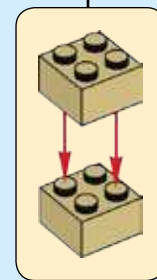
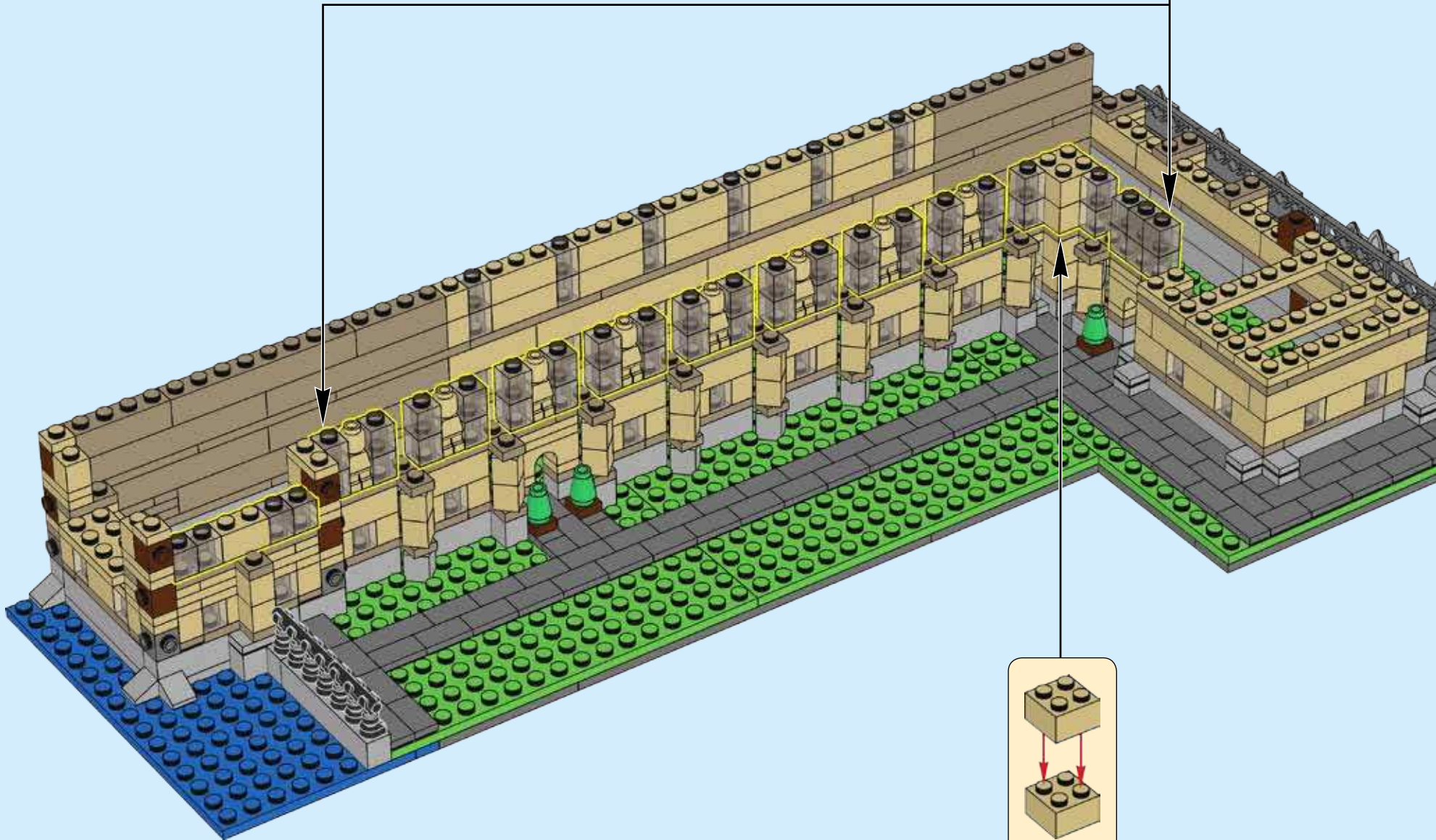
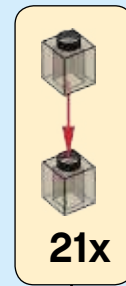

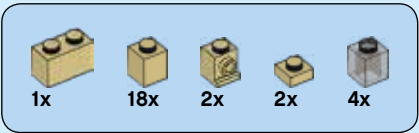

34

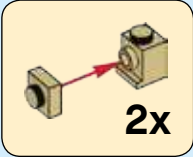
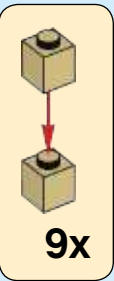

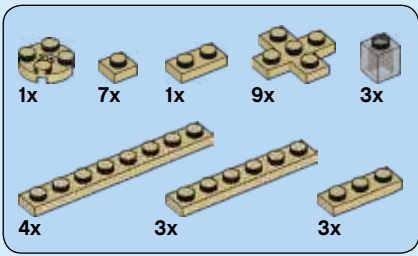

35



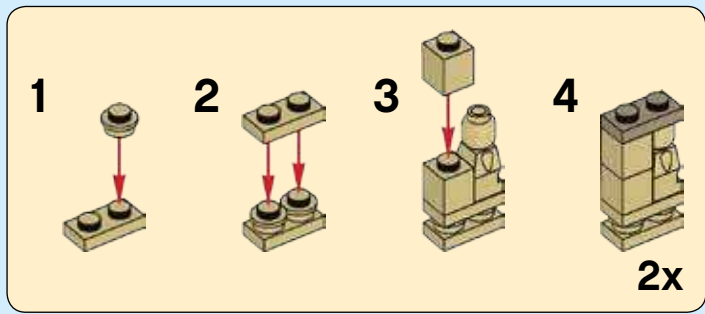
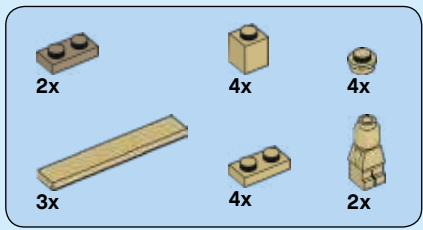

36



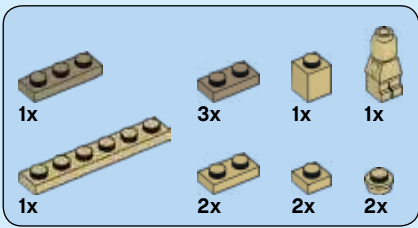

37

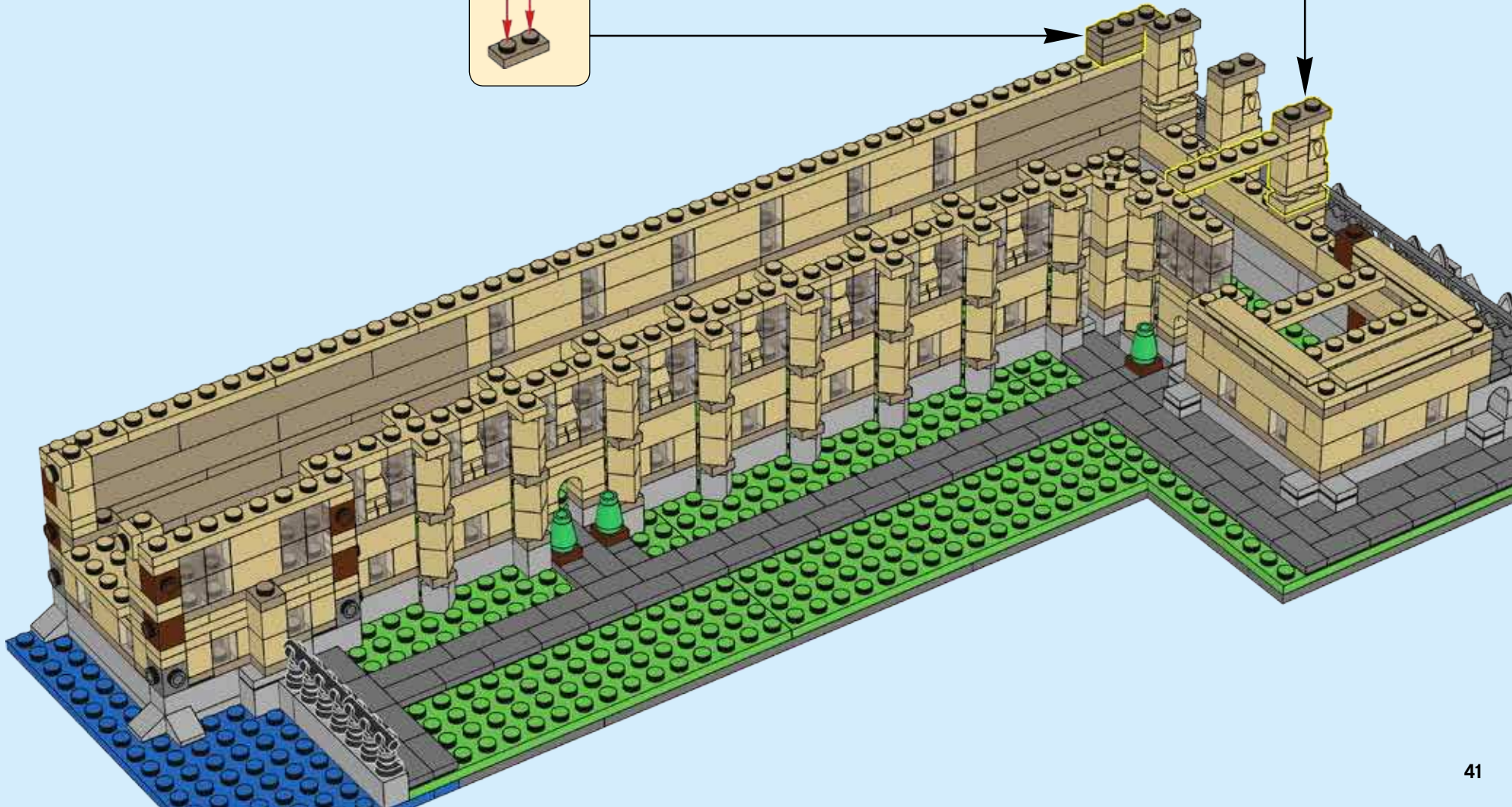
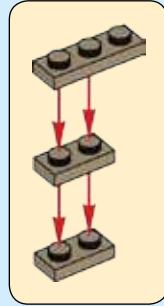
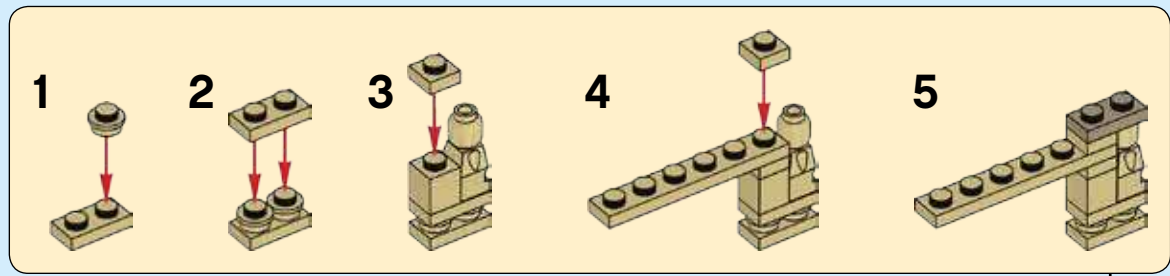

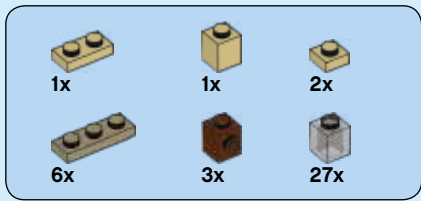

38

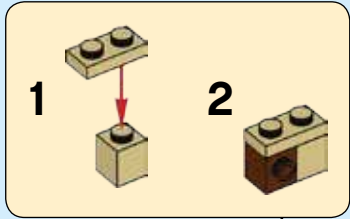
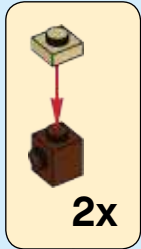
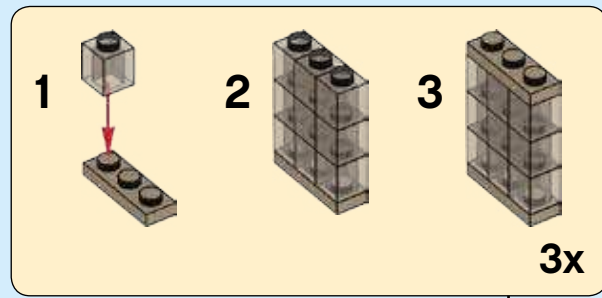

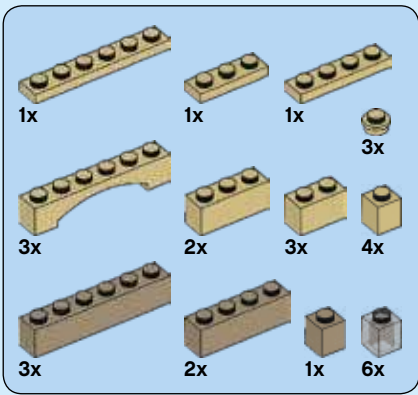

39



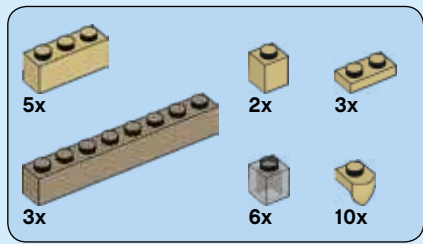

40



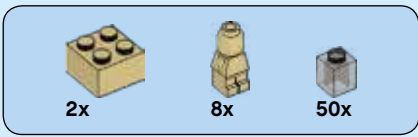

41

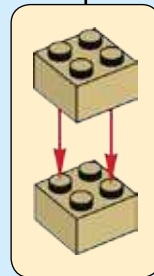
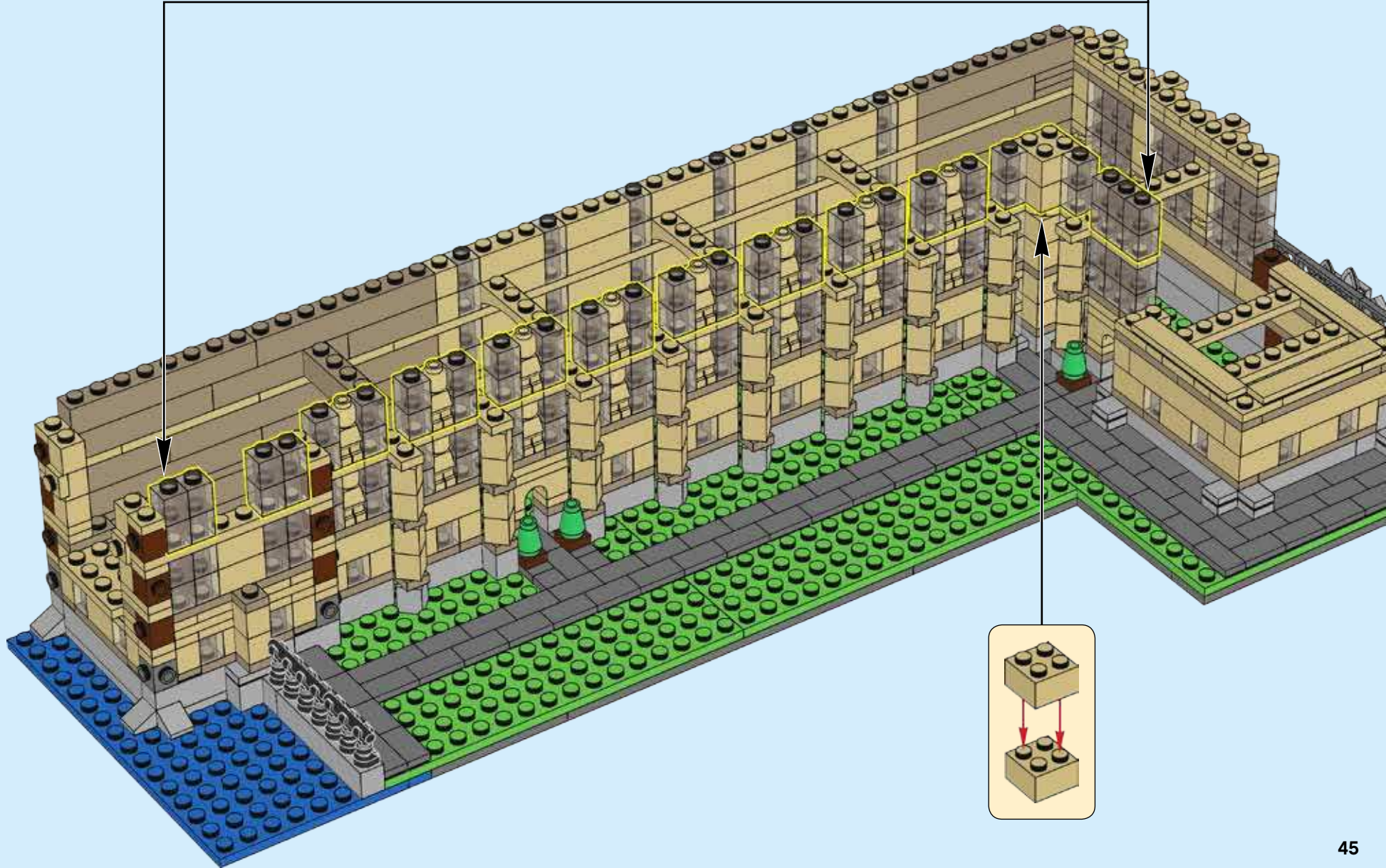
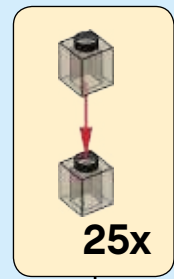

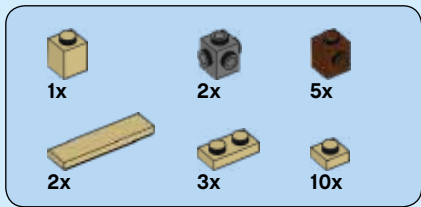

42

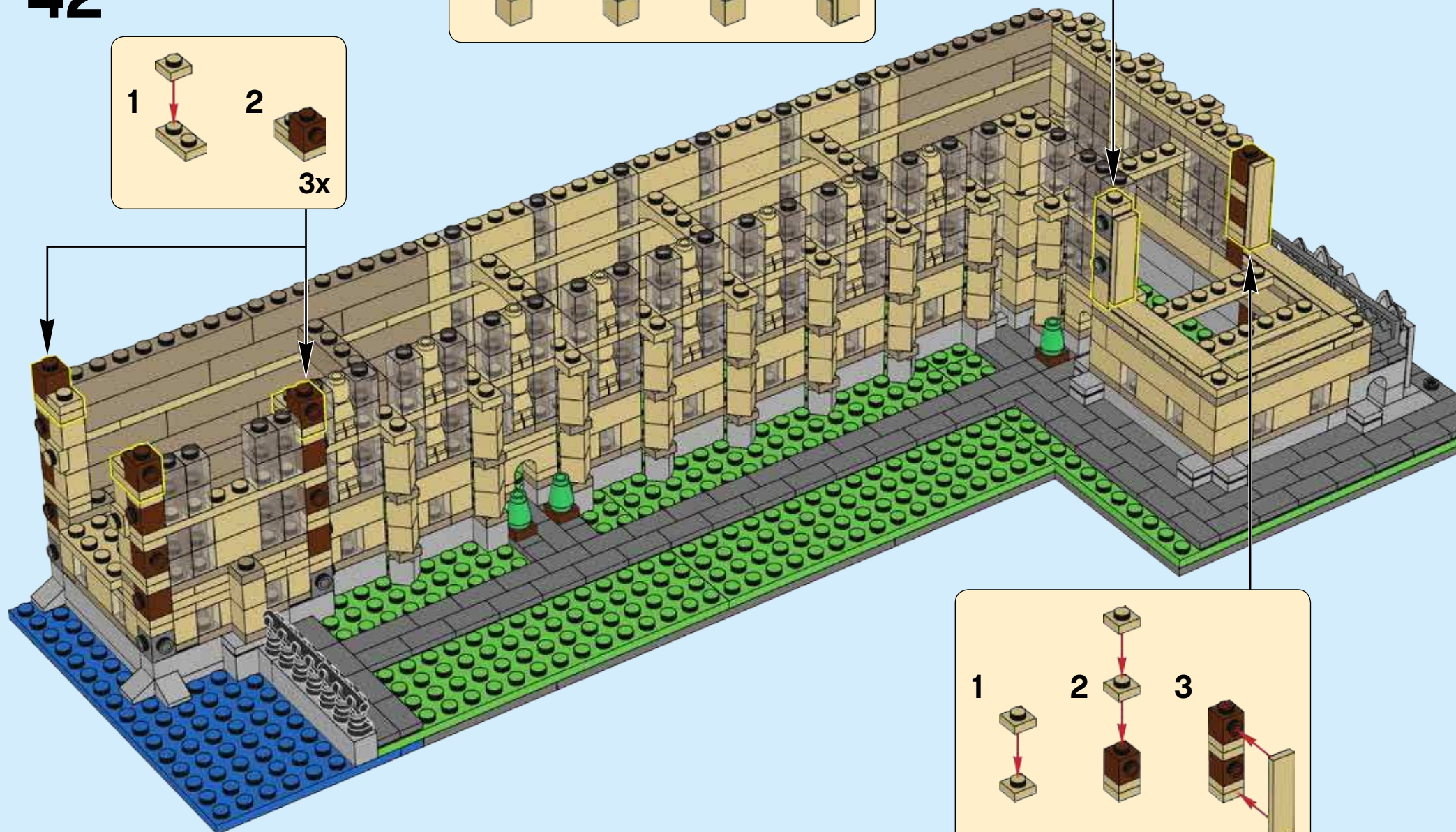
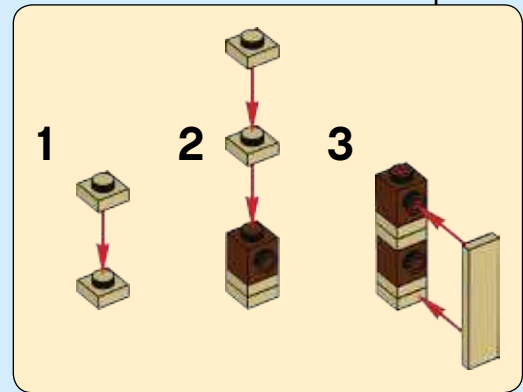
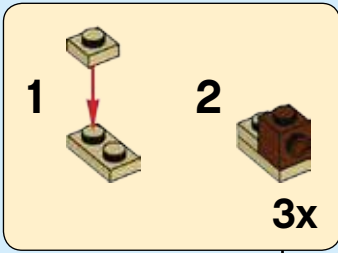
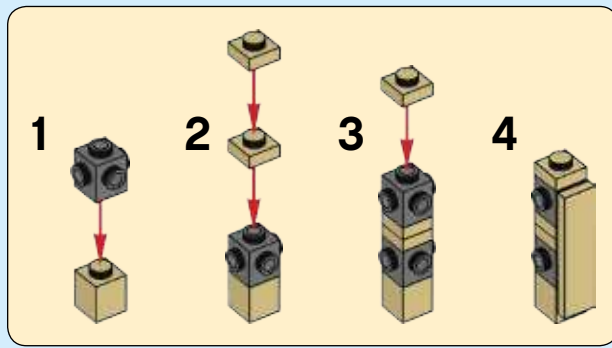

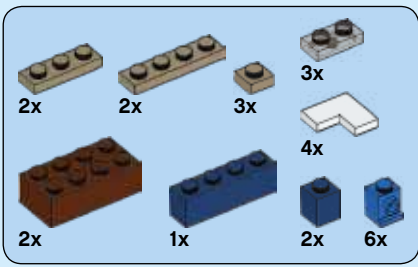

43



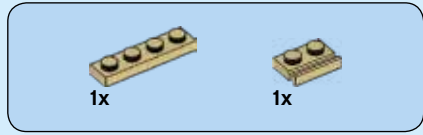

44

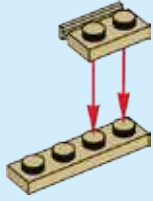

45

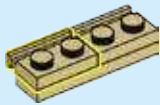

46

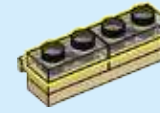

47





48

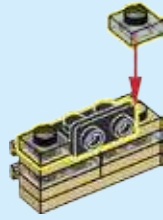

49

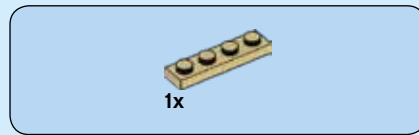
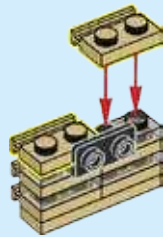

50

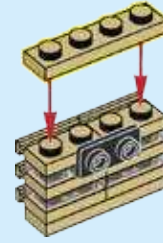

51

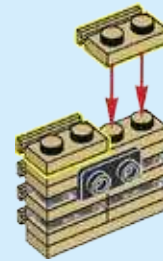



1x



2x

52

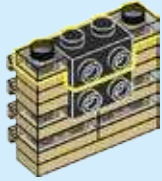

2x

53

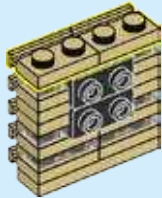

2x

54



2x



1x

55

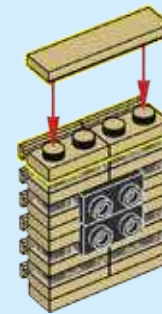

3x

56

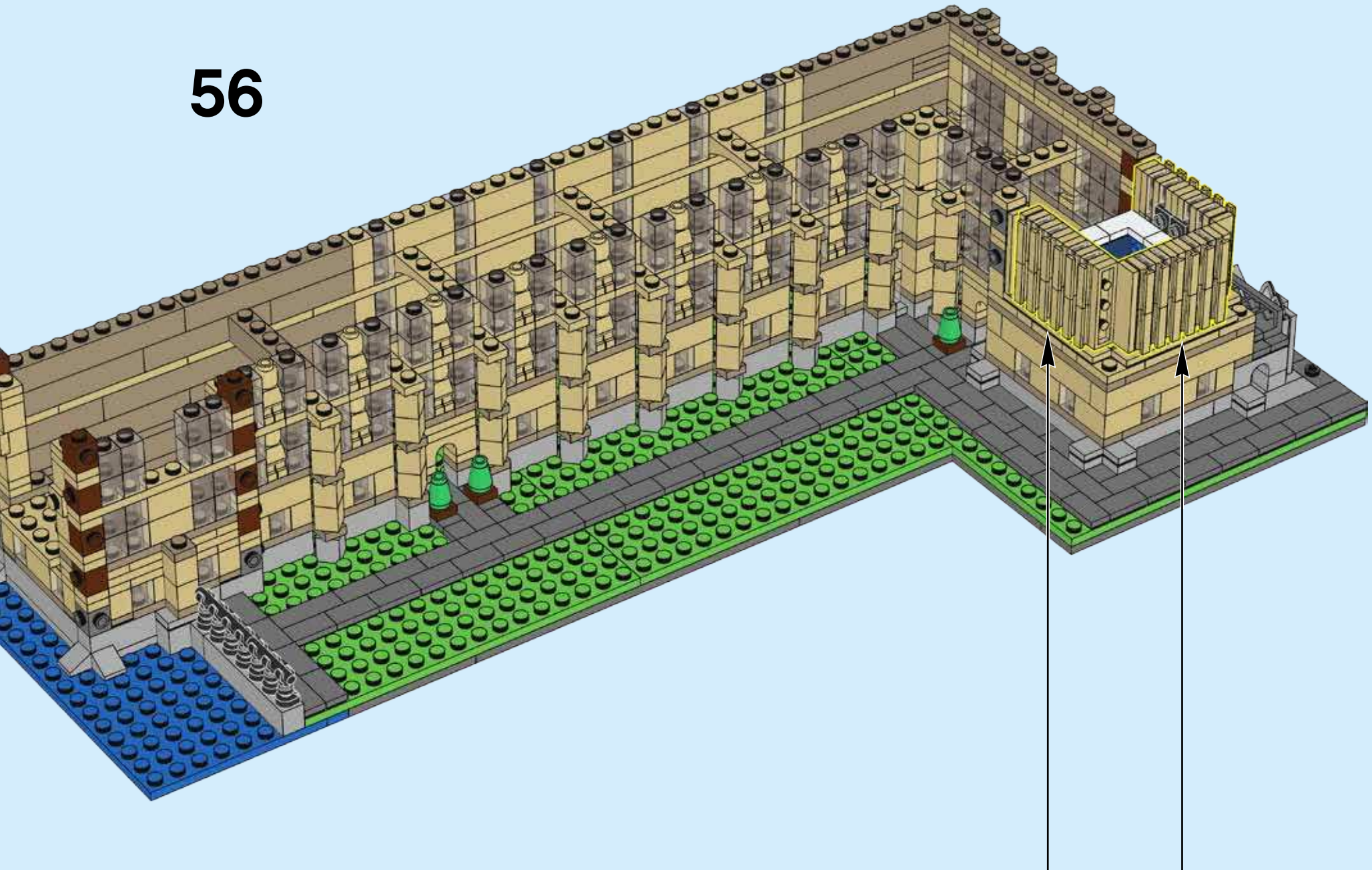

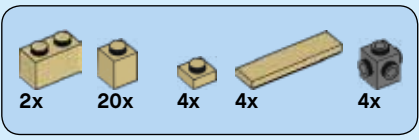

57

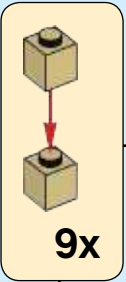
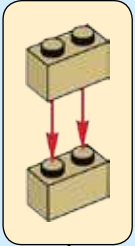
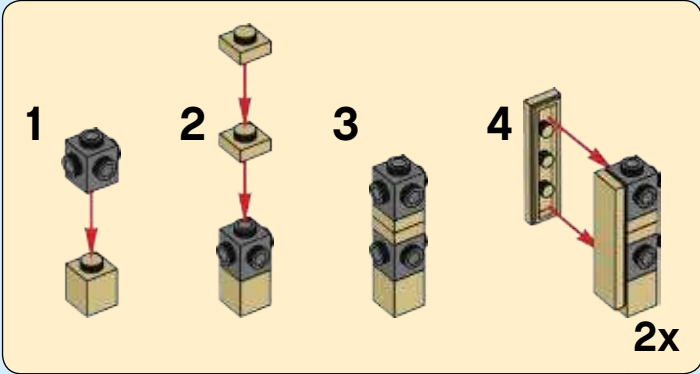

9x



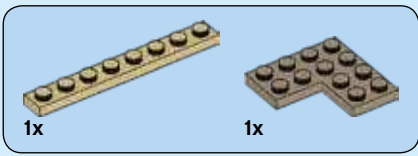

58

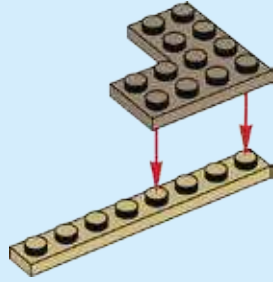

59

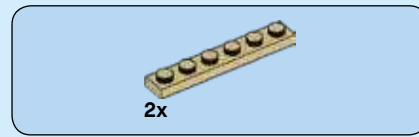
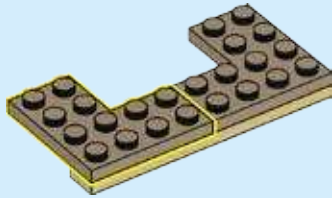

60

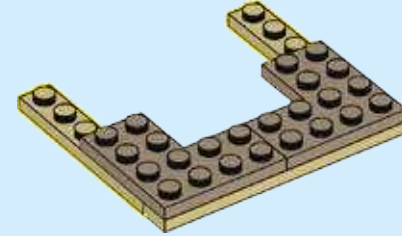

61

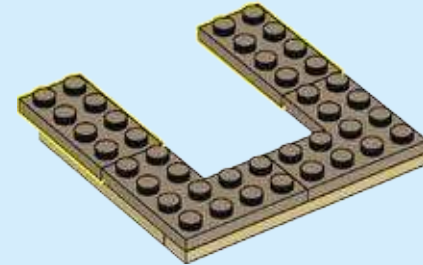

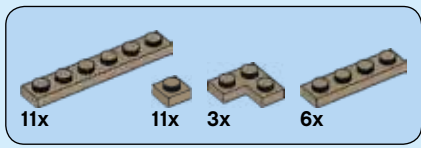





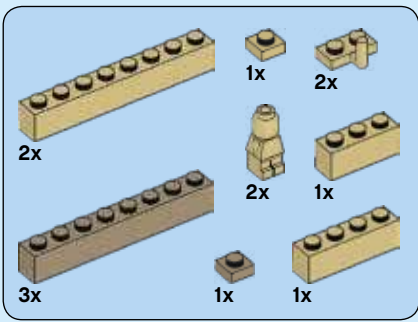

62

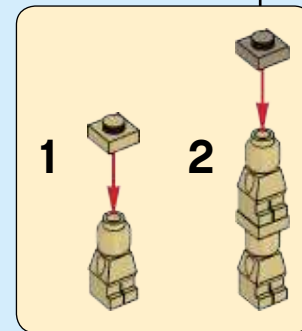
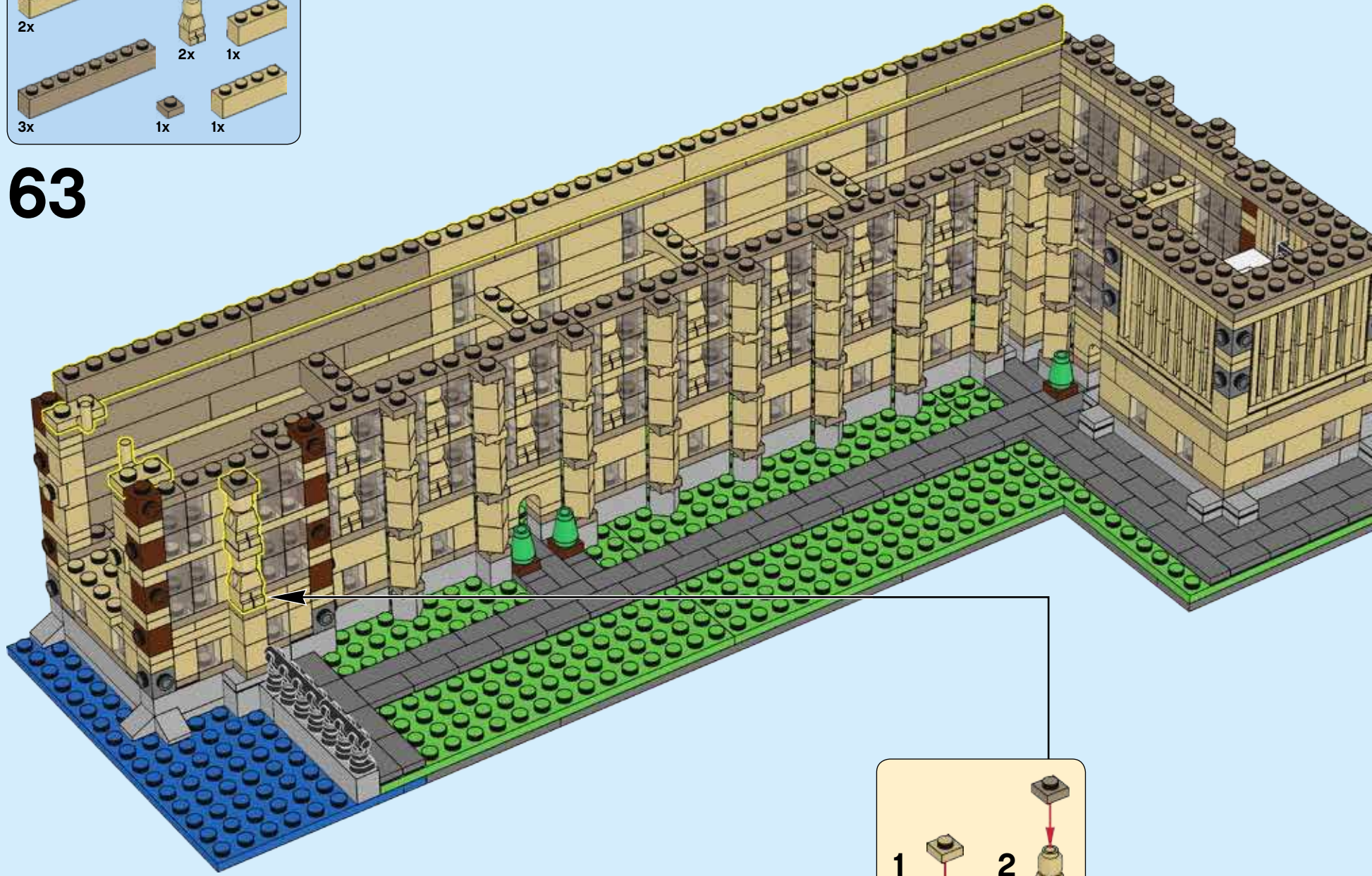



63



 4x	 22x	 36x
 3x	 1x	 1x

64



18x

1



2



2x



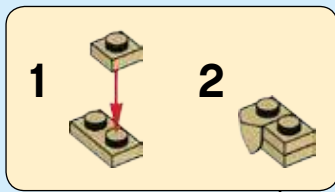
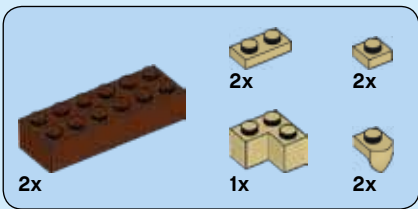

65

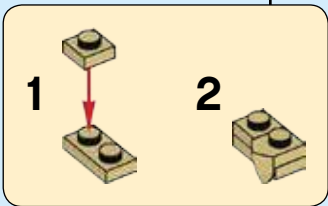
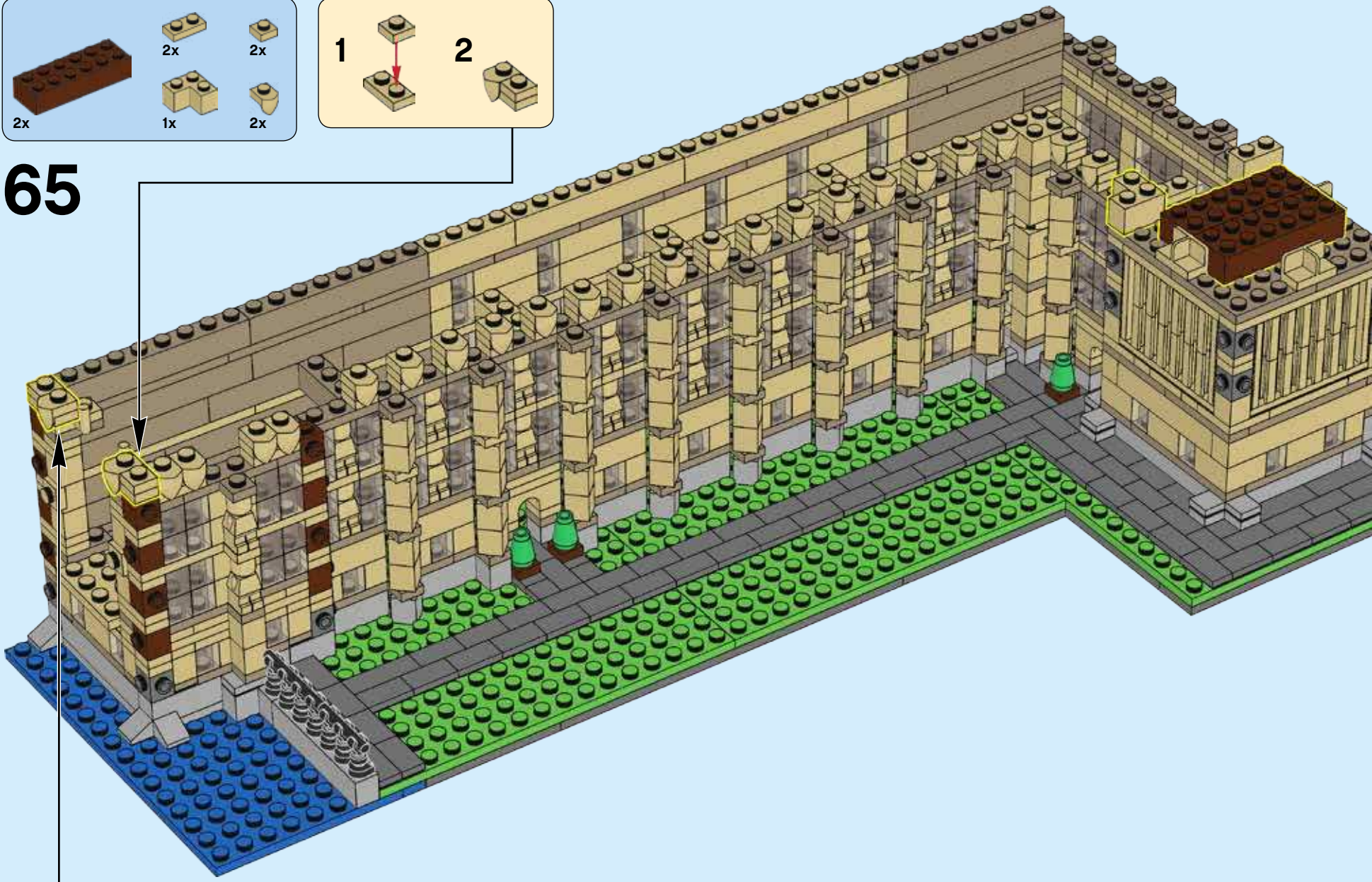



66

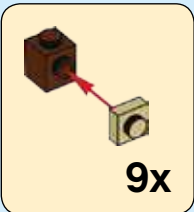
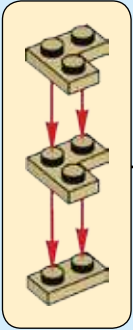

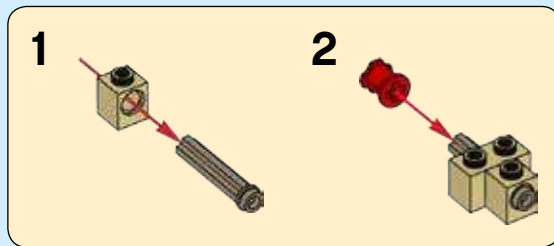
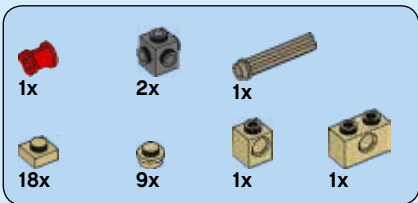

67

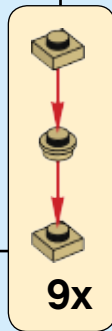
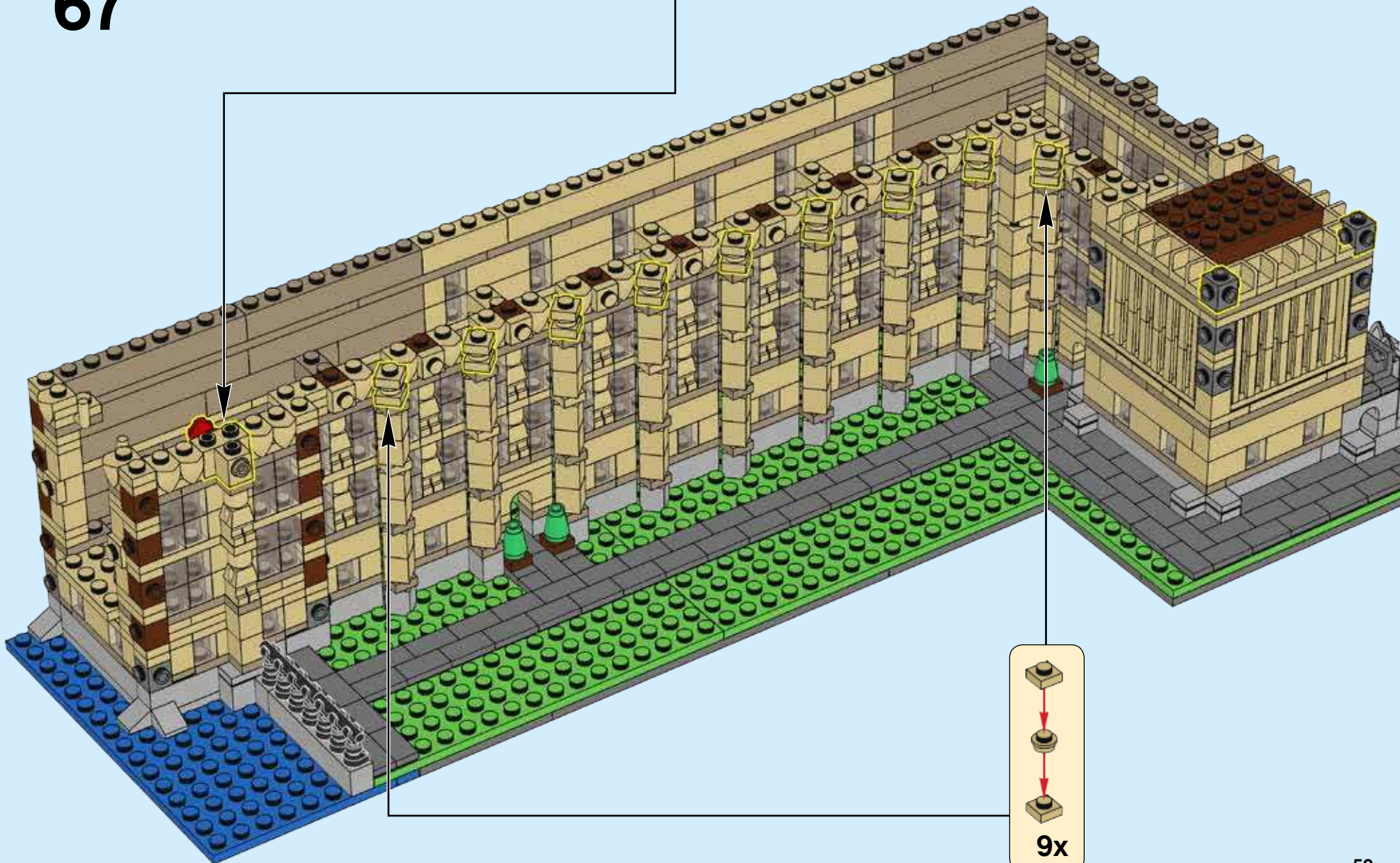

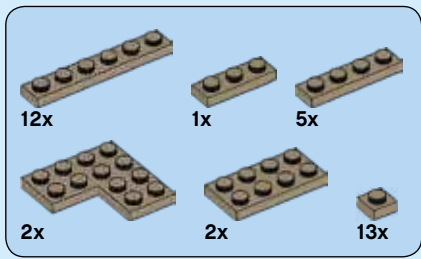

68



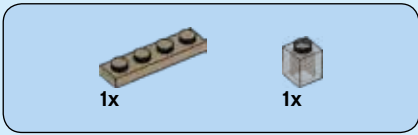

69

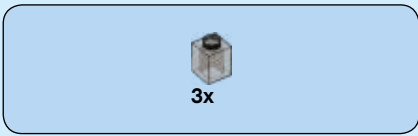
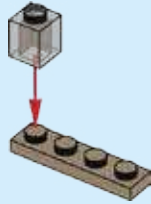

70

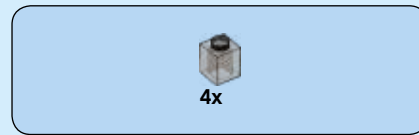

71

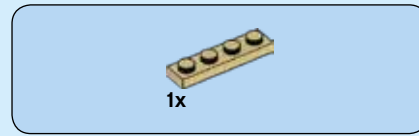

72





8x

73



1x



1x

74



1x



2x

75



4x

76









77







-  The lantern near the top was added so Queen Victoria could see when members of parliament were working into the night.
-  Die Laterne nahe der Turmspitze wurde angebracht, damit Königin Victoria immer sehen konnte, wenn Mitglieder des Parlaments bis in die Nacht hinein arbeiteten.
-  La lanterne proche du sommet fut ajoutée afin que la Reine Victoria puisse voir lorsque les membres du parlement travaillaient la nuit.
-  El faro superior se agregó para que la reina Victoria pudiera saber si los miembros del parlamento estaban trabajando durante la noche.
-  A lanterna no topo foi acrescentada para que a Rainha Victoria pudesse ver quando os membros do parlamento trabalhavam à noite.
-  A csúcs közelében elhelyezett lámpást azért szerelték fel, hogy Viktória királynő láthassa, ha a parlament éjjel is ülészik.



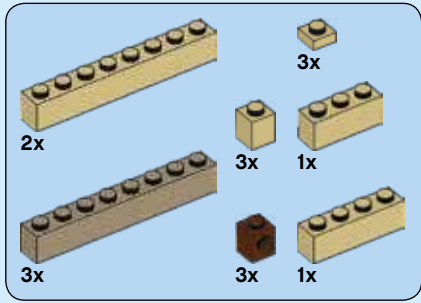
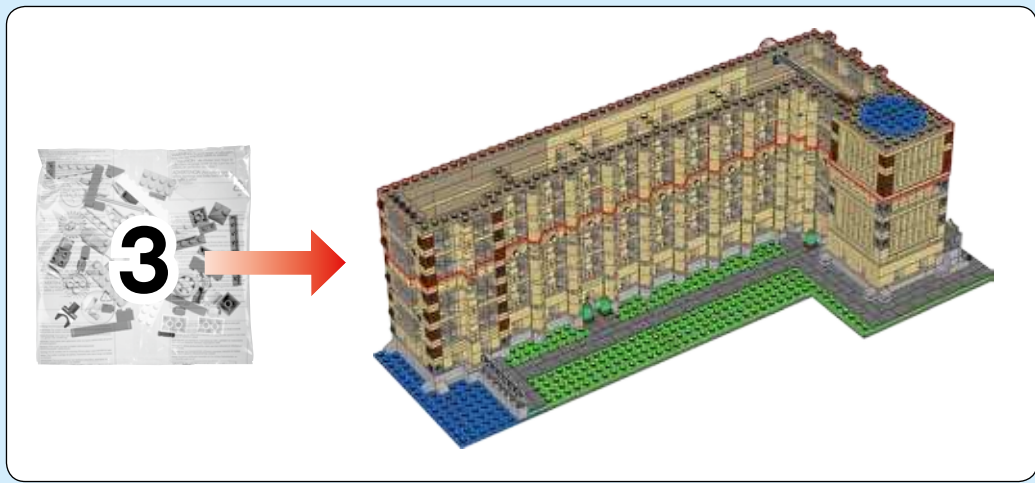

78

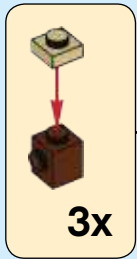

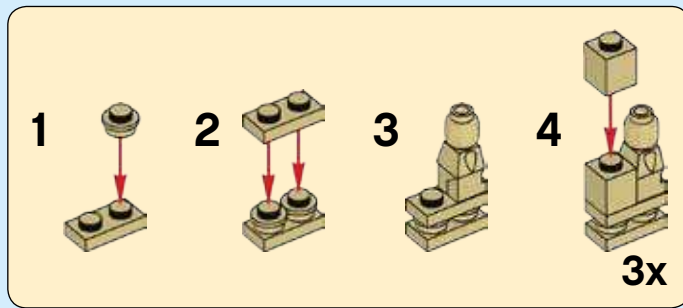
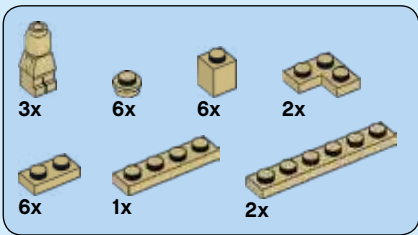

79



1x 30x

80

10x



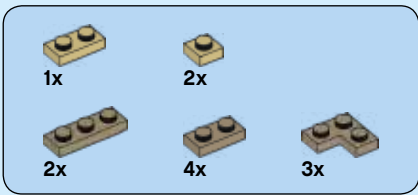

81

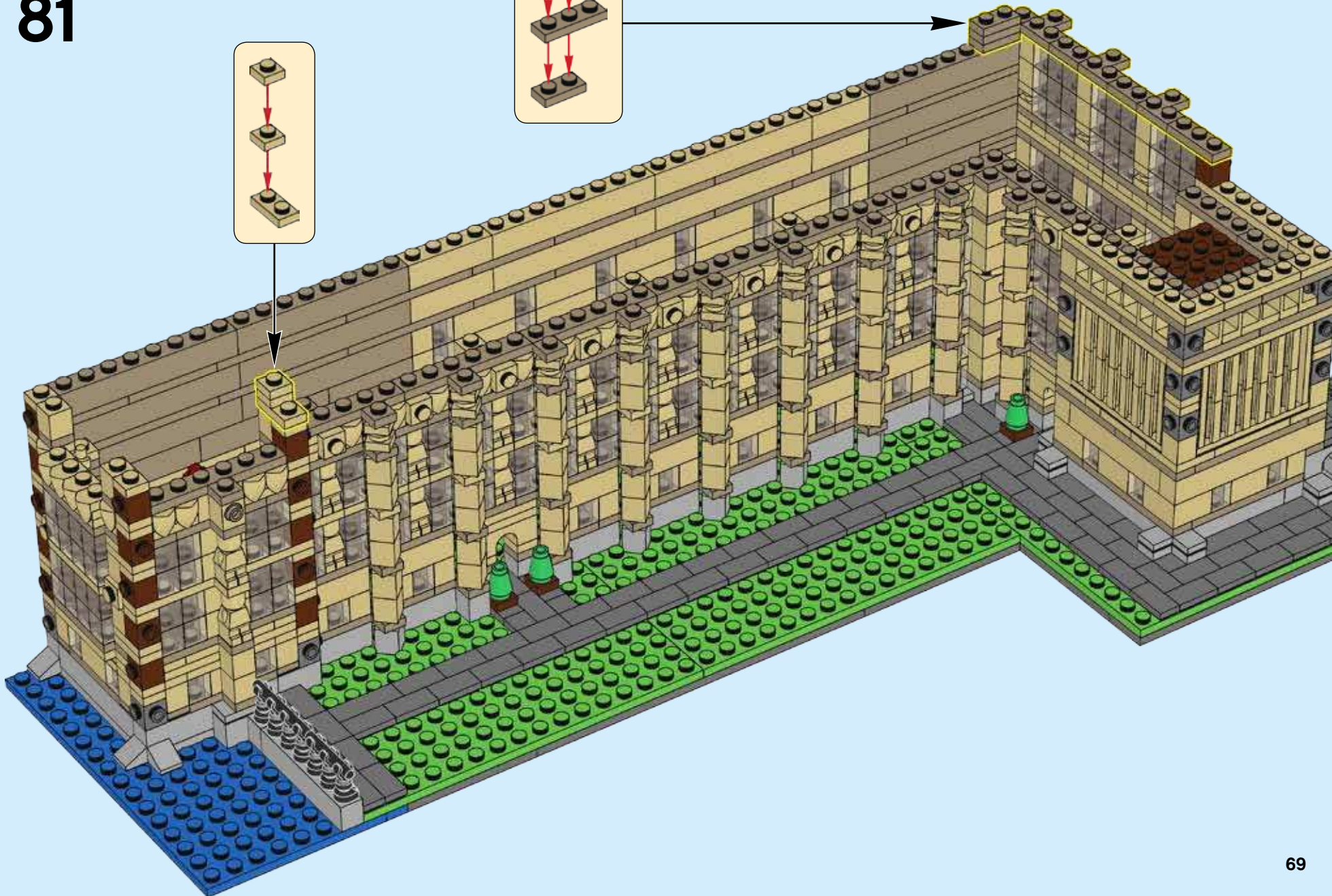
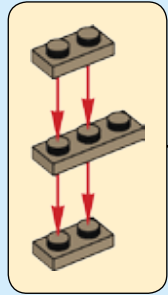
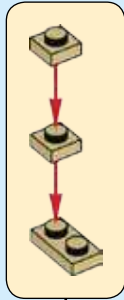

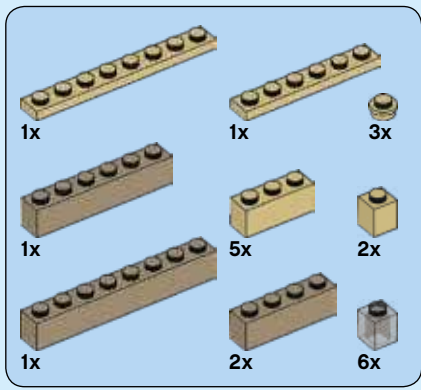

82





83

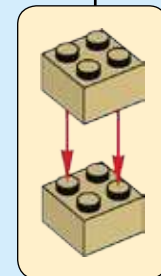
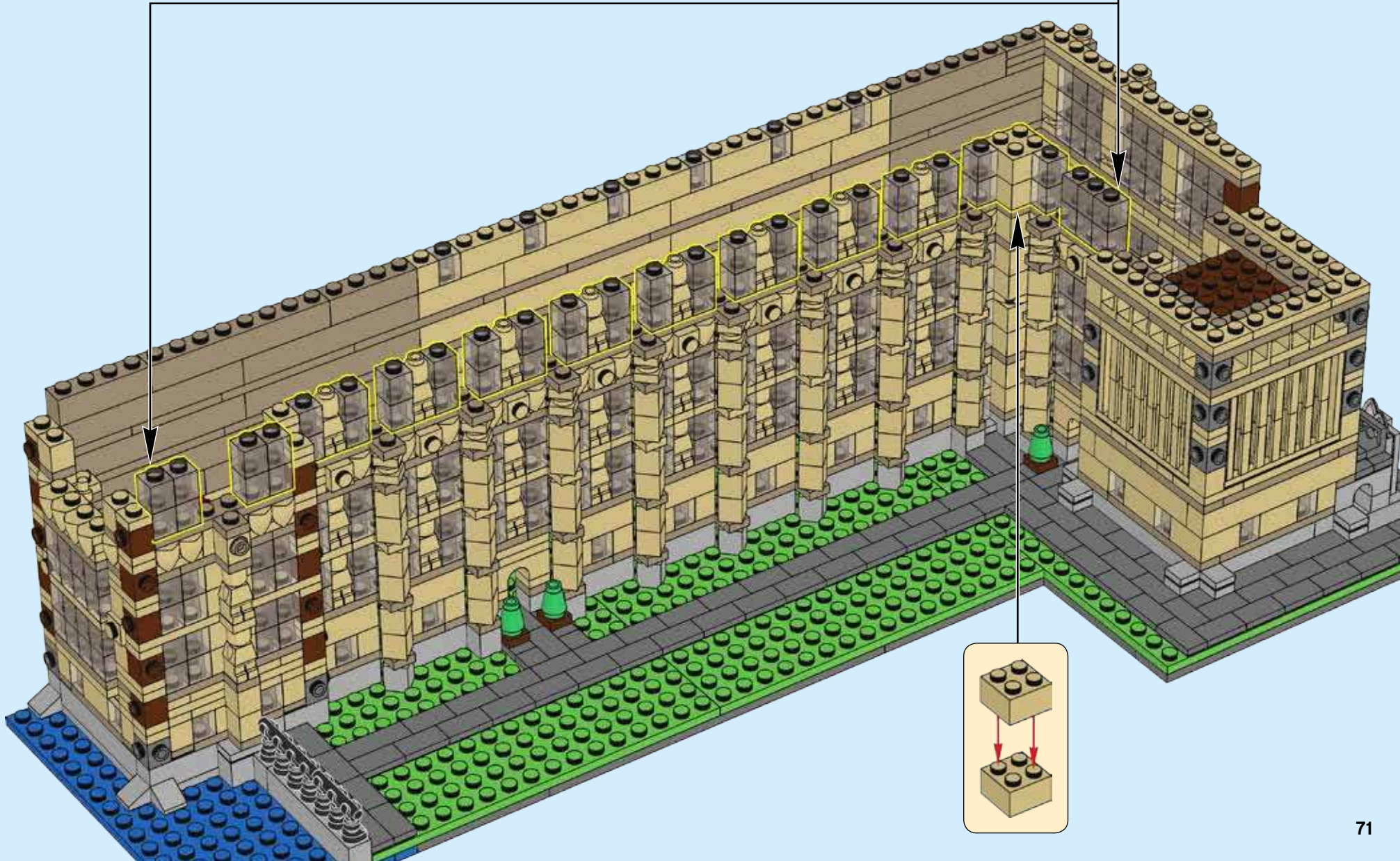

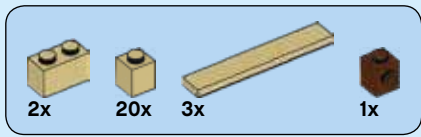

84

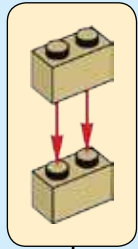
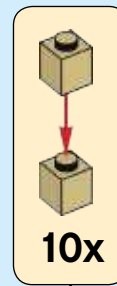

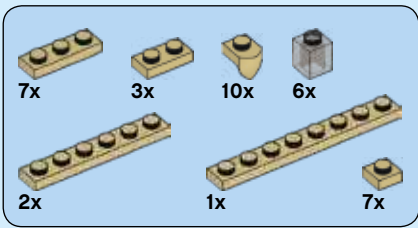

85

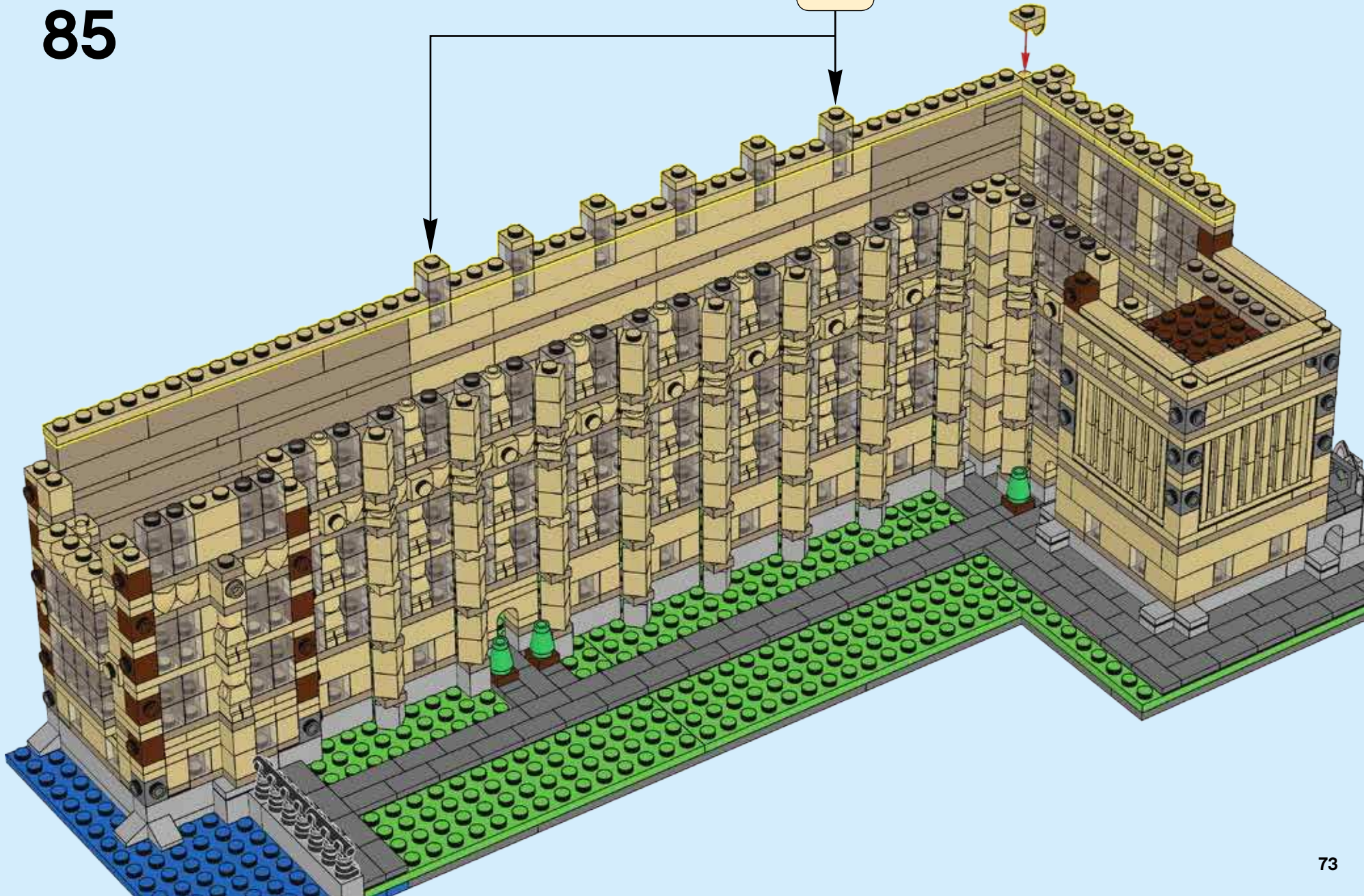

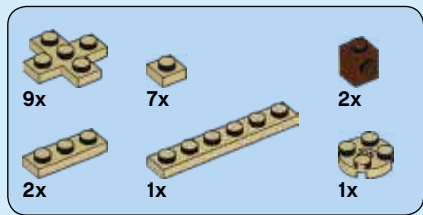

86



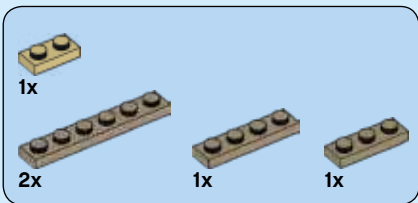

87





88

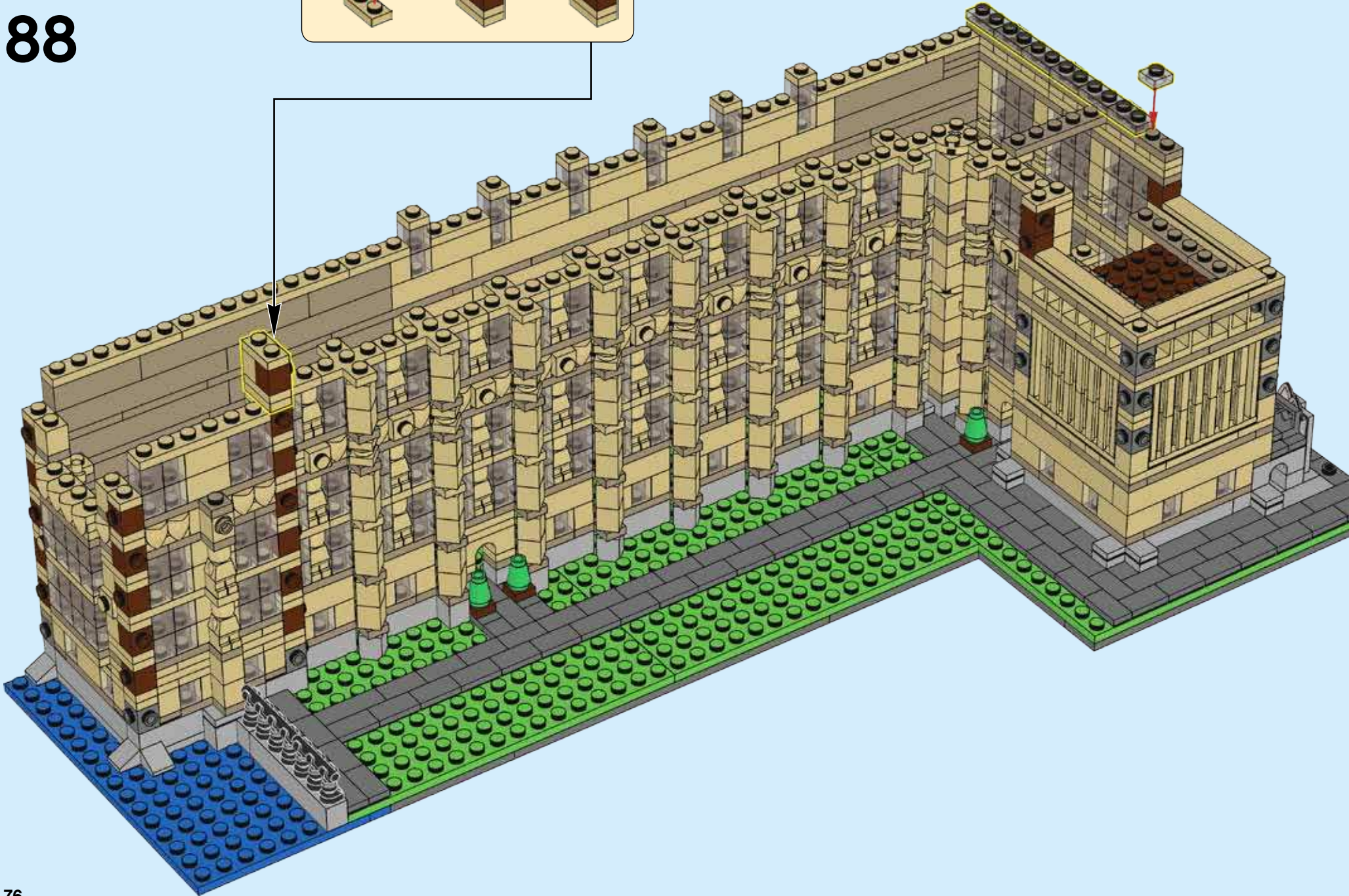

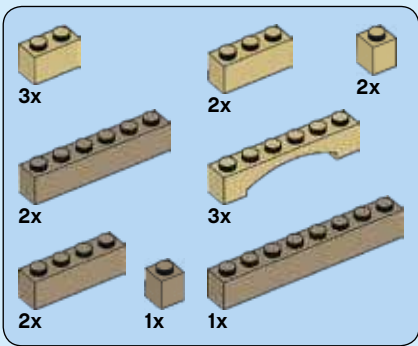

89





3x



10x

90



3x 4x 3x

91



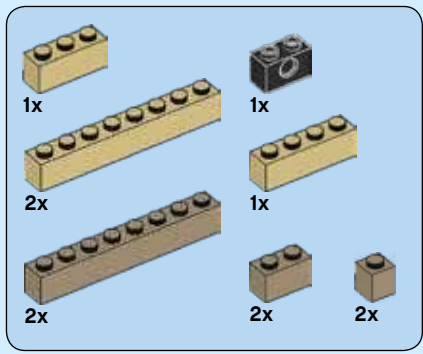





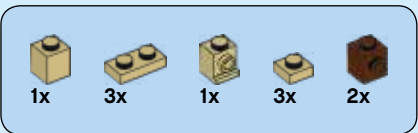

92

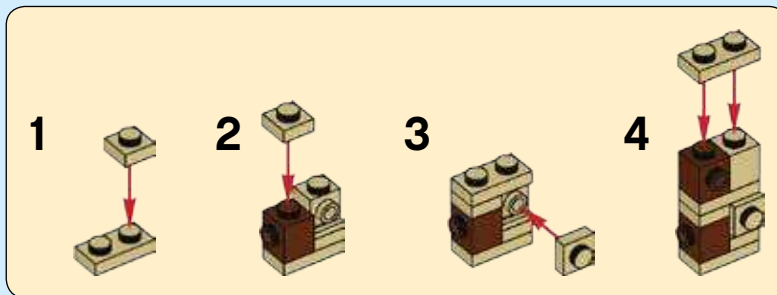



93



-  1x
-  3x
-  1x
-  3x
-  2x

94

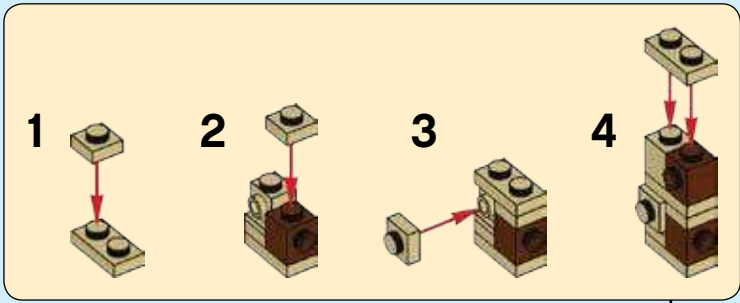

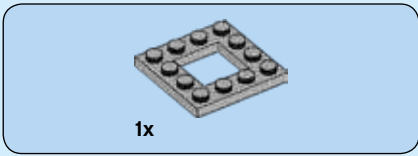

95

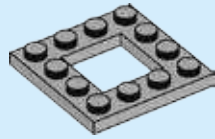

96

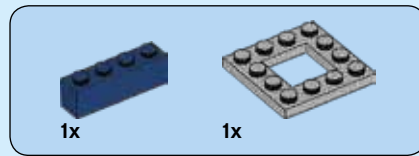

97

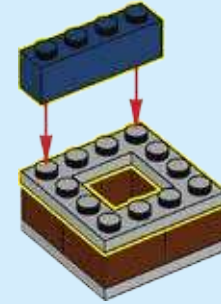

98

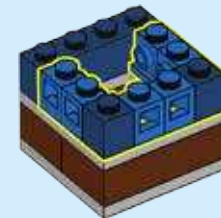

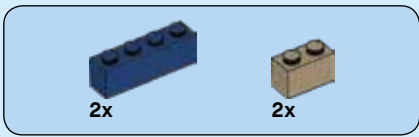

99

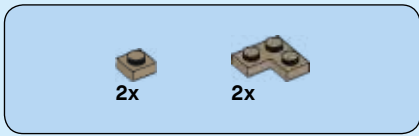
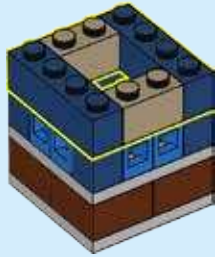

100

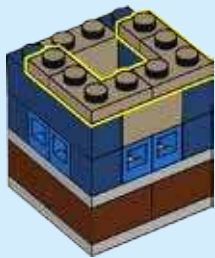

101

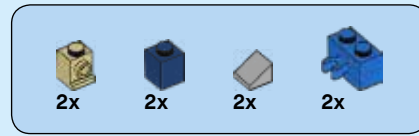
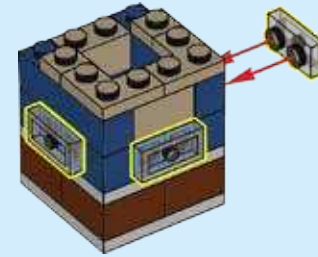

102

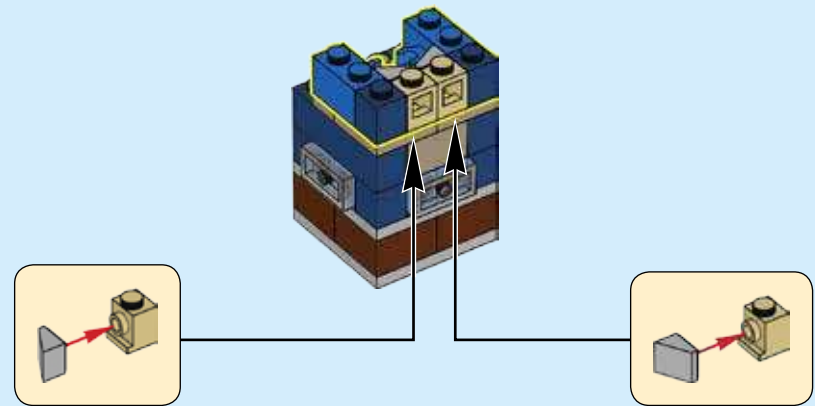

103



2x
8x
50x

25x

104



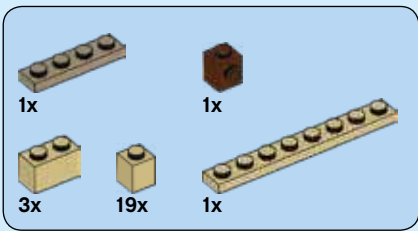

105

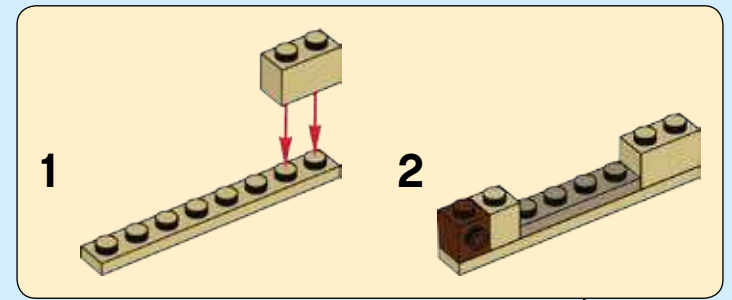
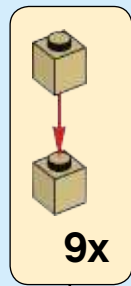

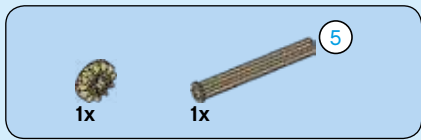

106

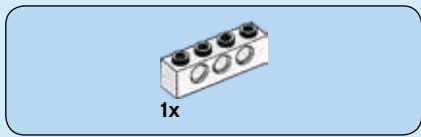
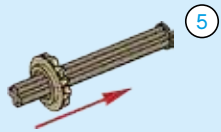

107

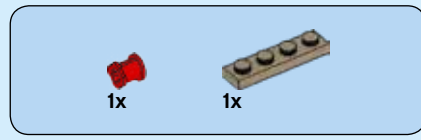
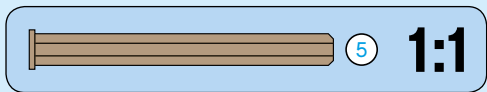
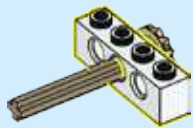

108

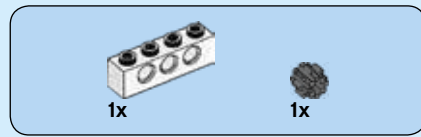
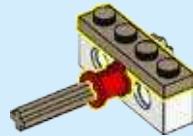

109

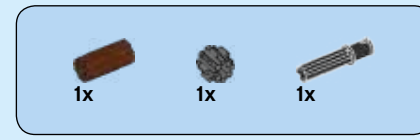
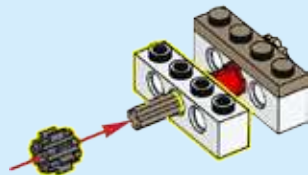

110

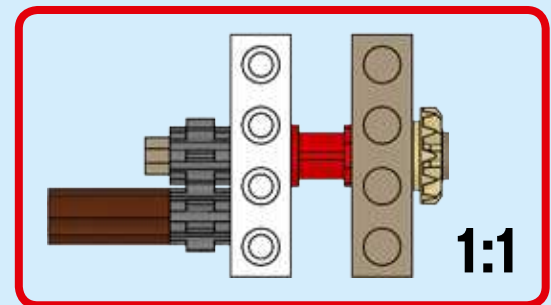
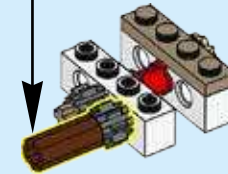
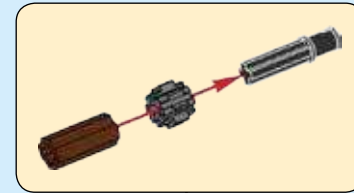

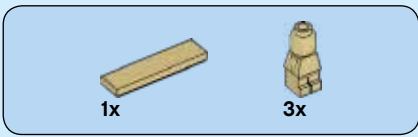

111

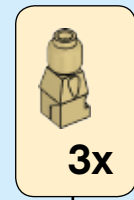

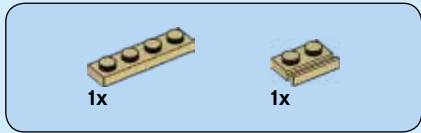
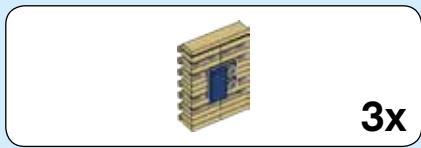

112

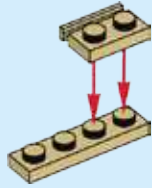

113

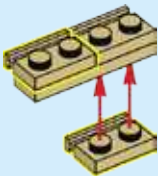

114

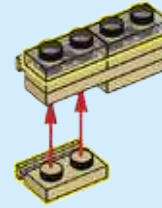

115

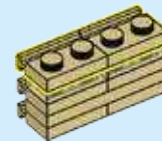



116

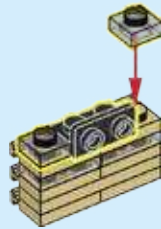

117

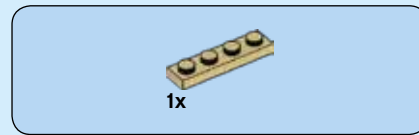
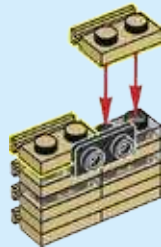

118

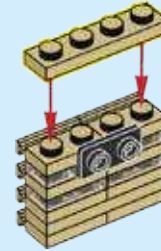

119

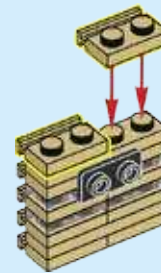



1x



2x

120



2x

121



1x



2x

122

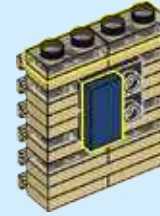

2x



1x

123

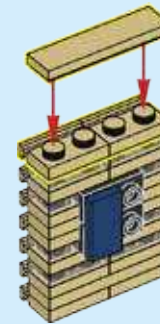

3x

124



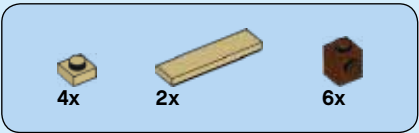

125

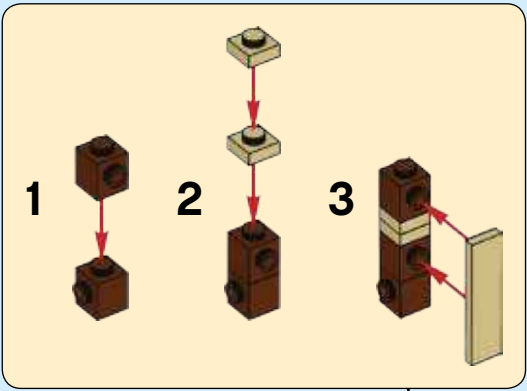
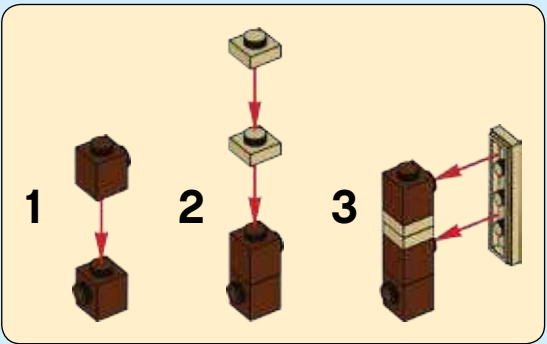

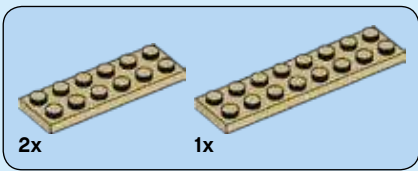

126



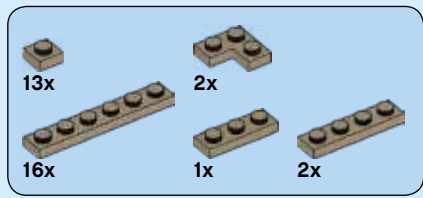

127



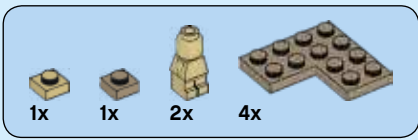

128

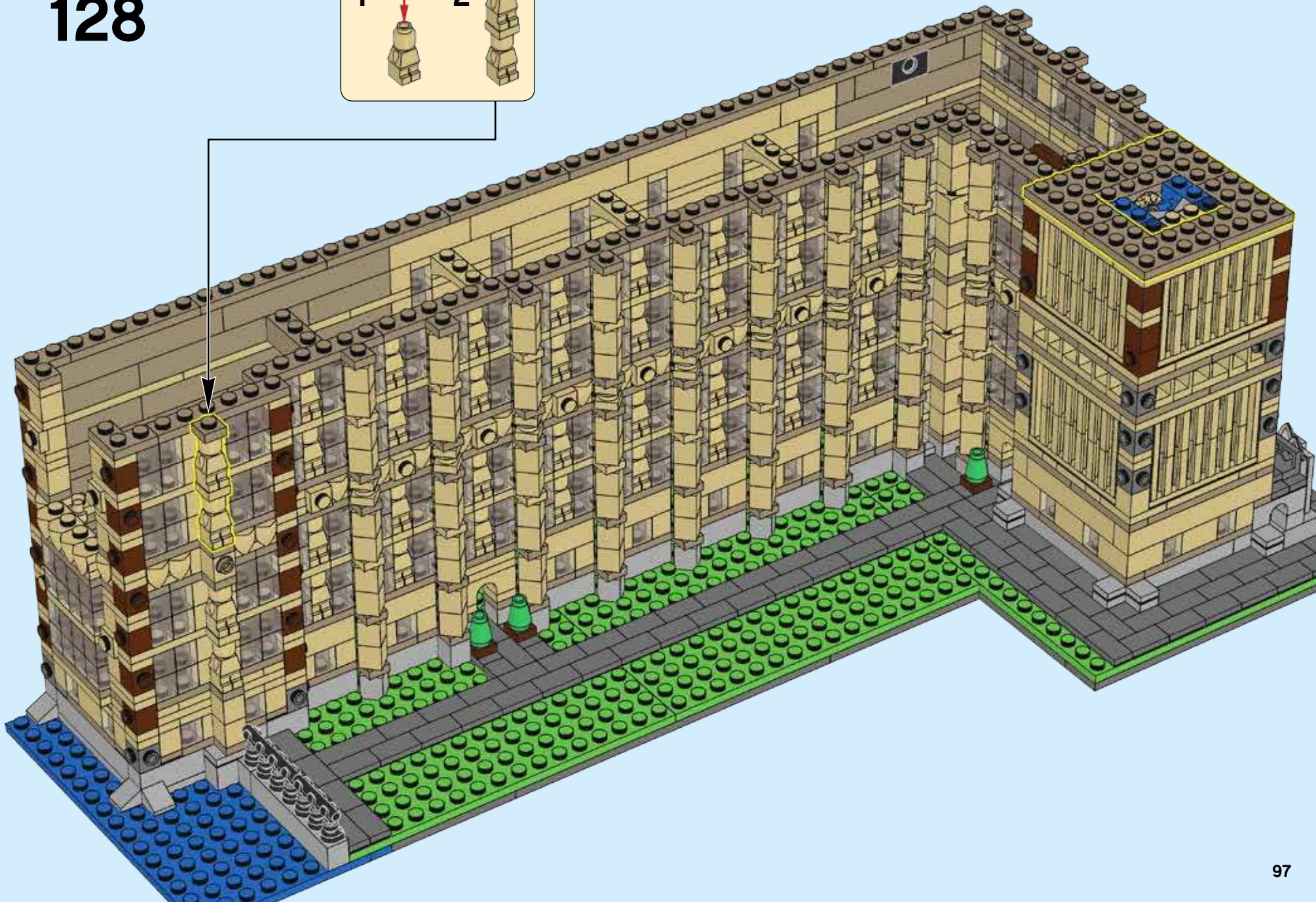
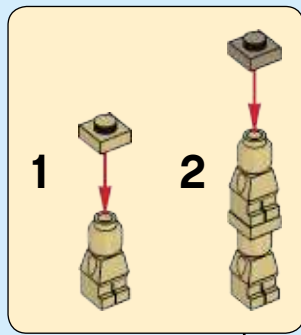

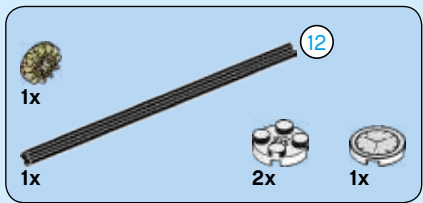

129

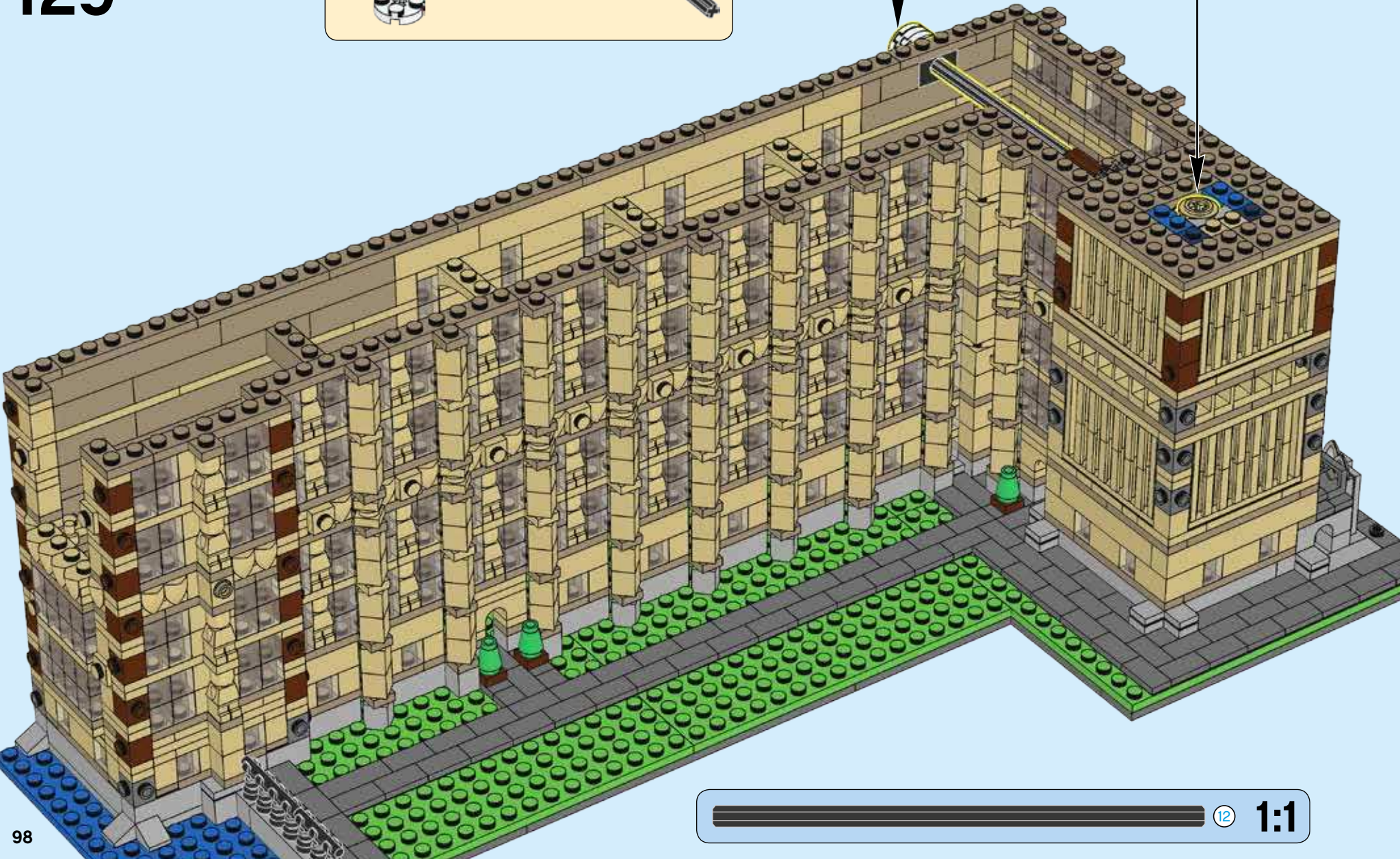
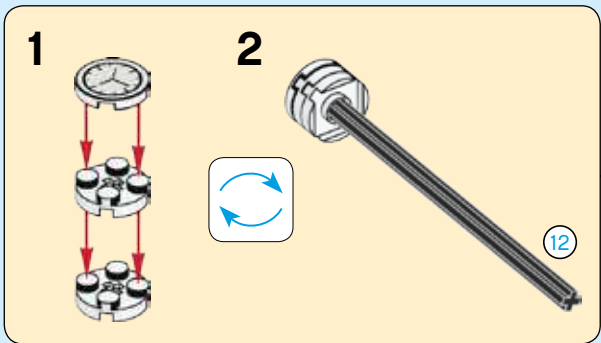

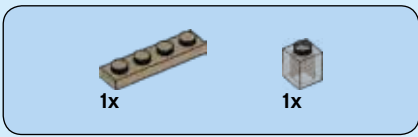

130

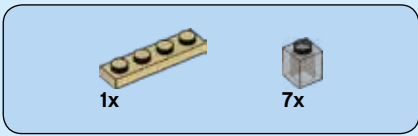
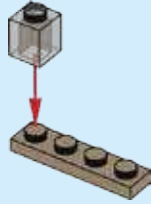

131

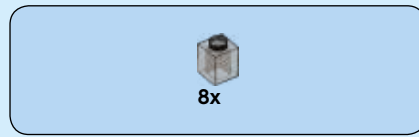
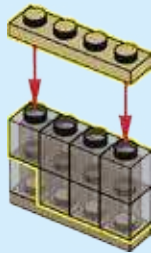

132

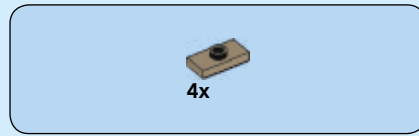

133



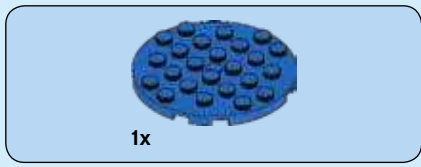

134

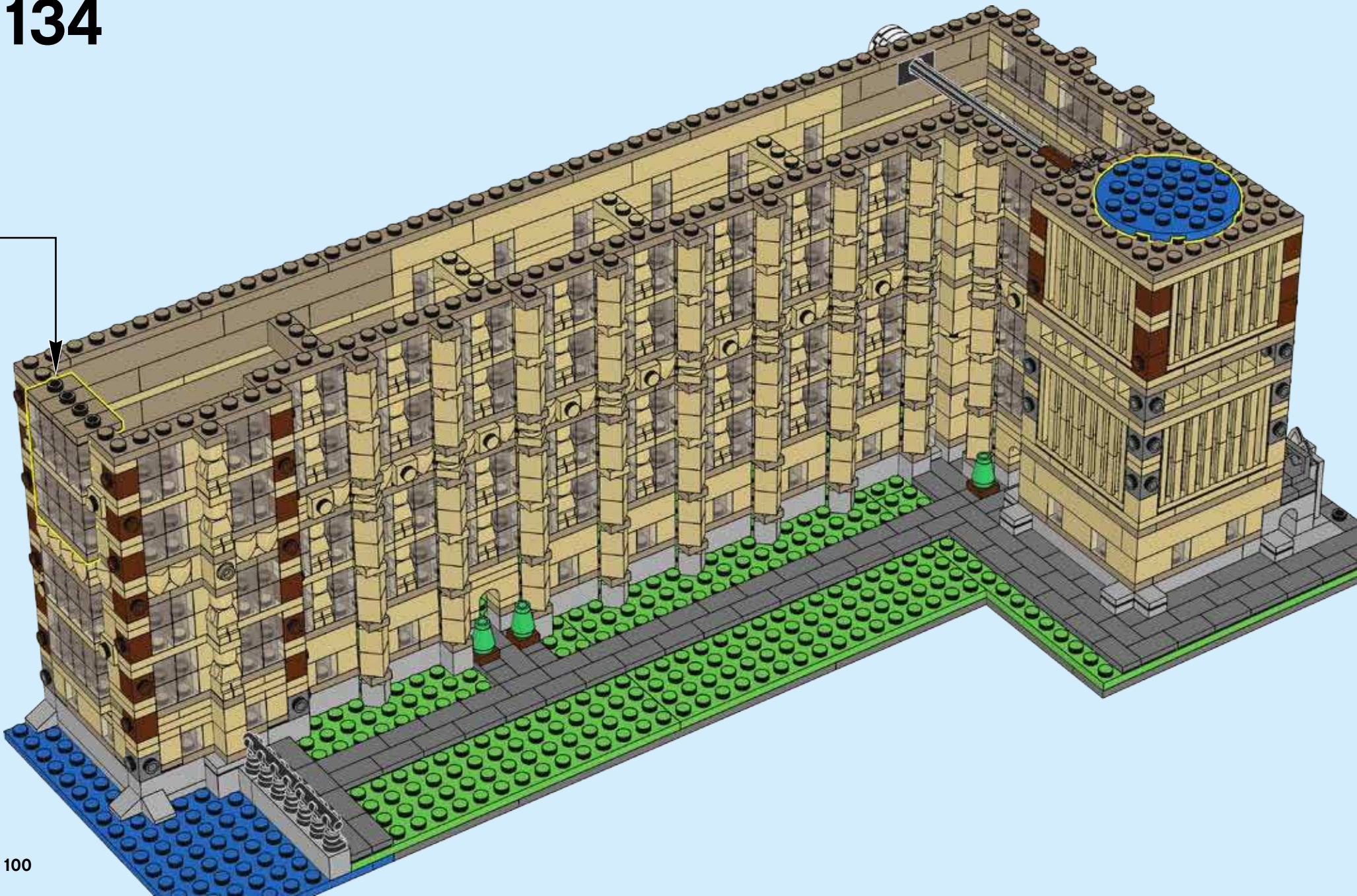

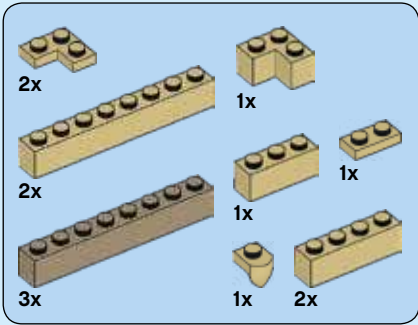
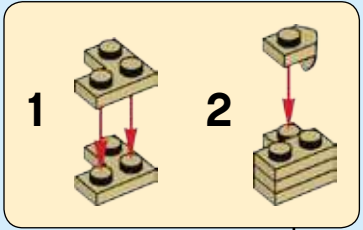
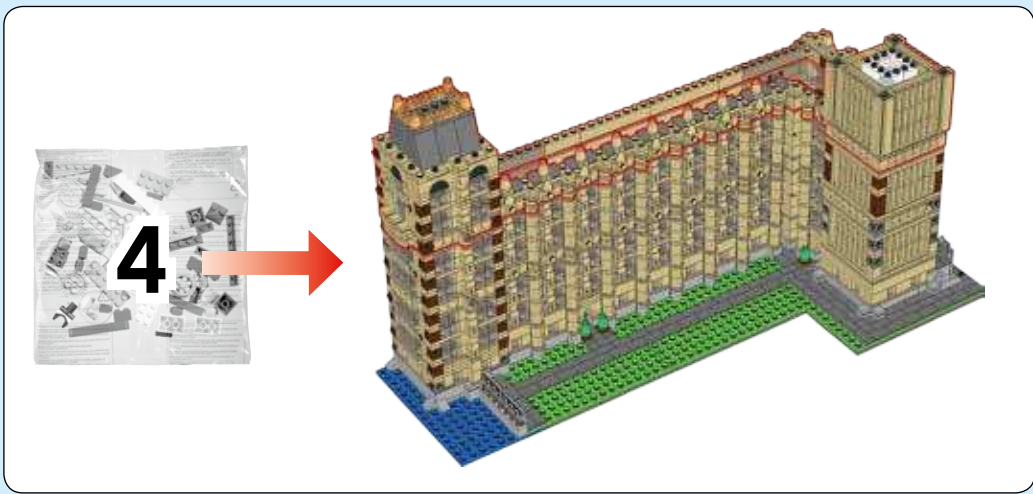

135



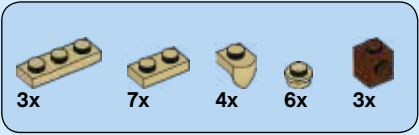

136

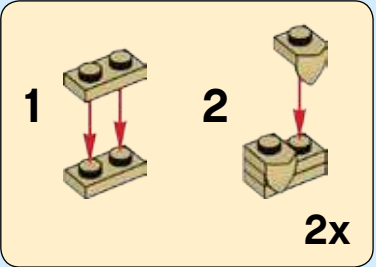
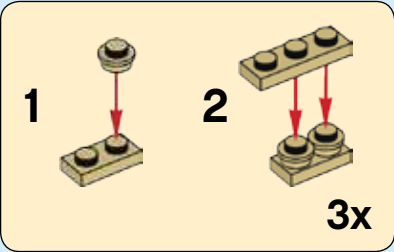

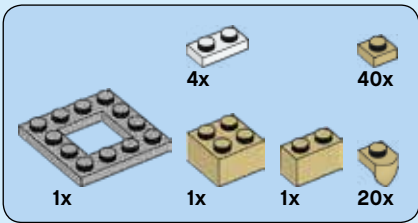

137

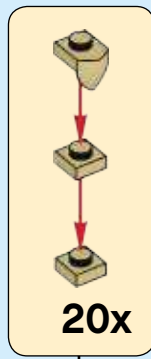

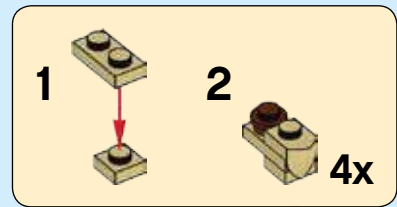
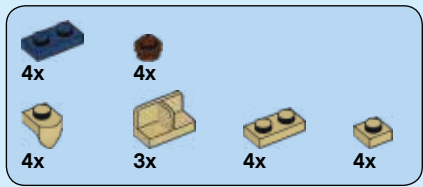

138



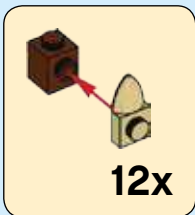
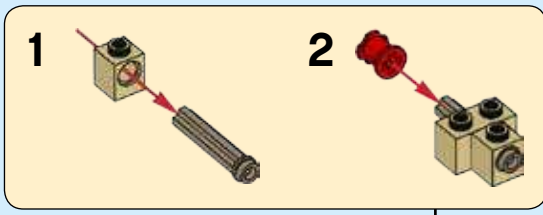

139



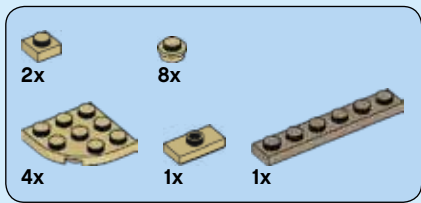

140

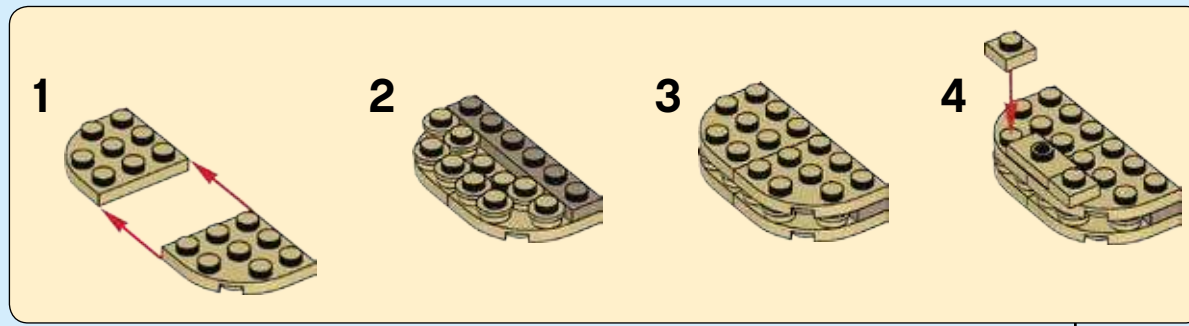

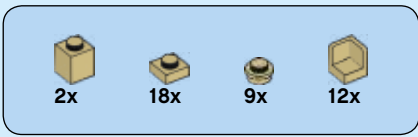

141

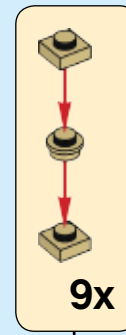

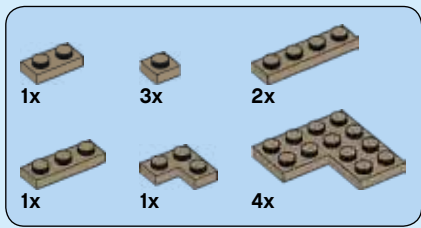

142



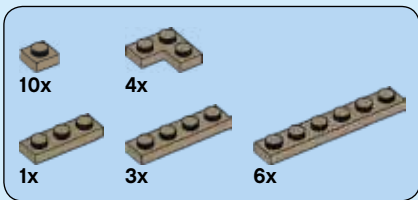

143



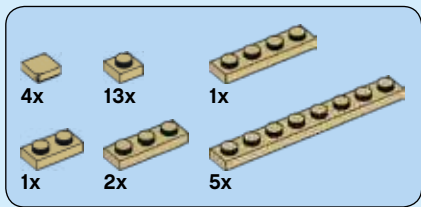

144



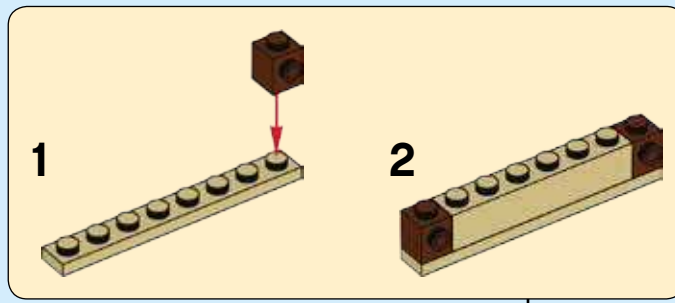
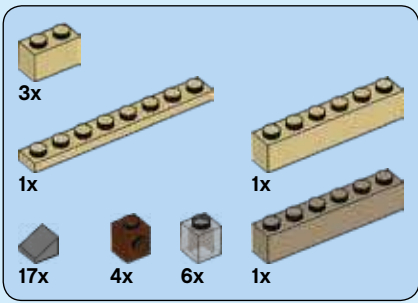

145



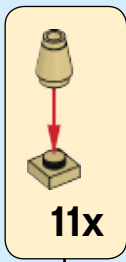
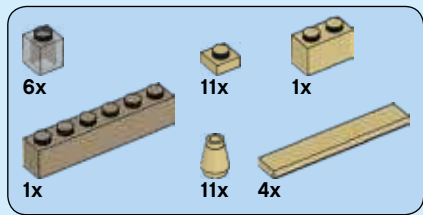

146



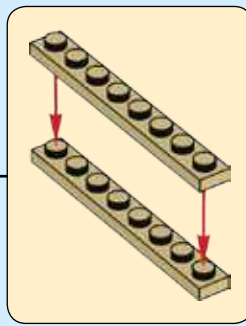
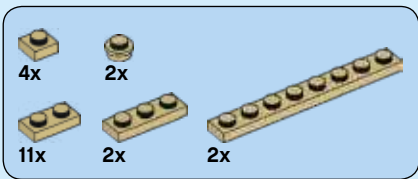

147

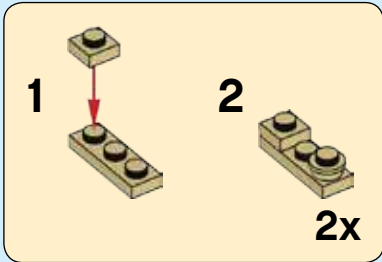

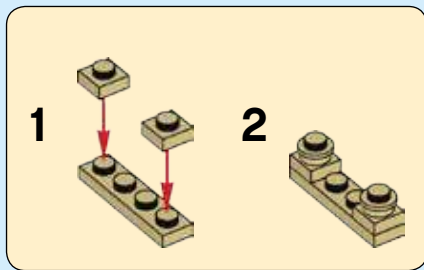
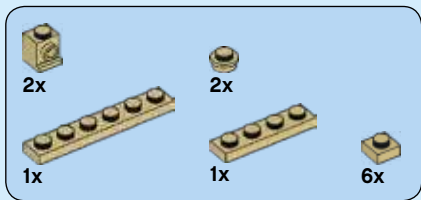

148

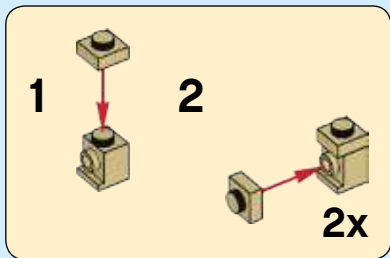

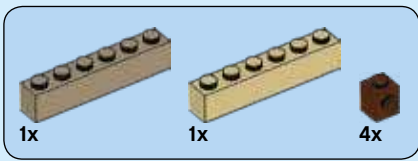

149



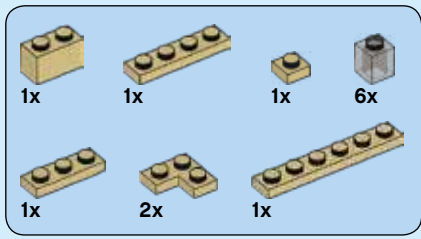

150



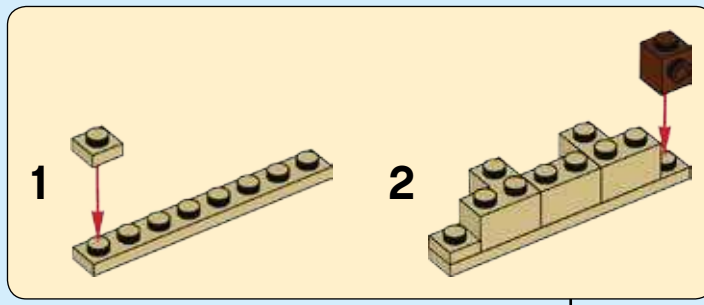
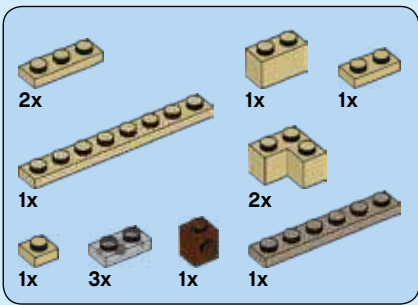

151

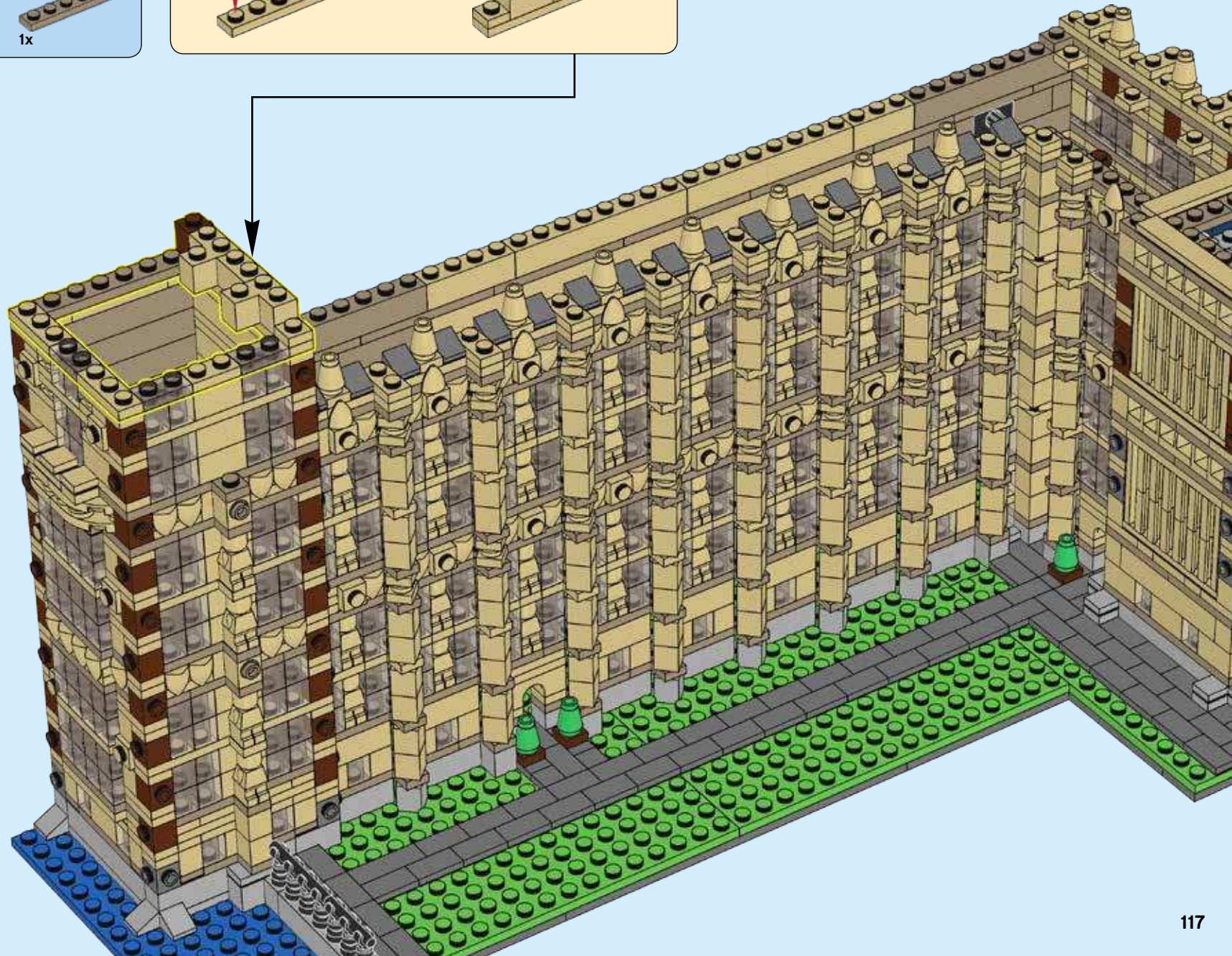

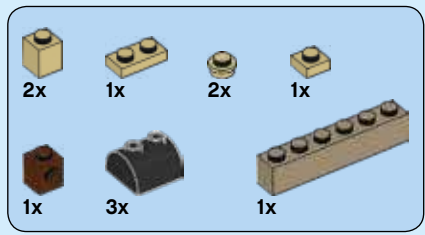

152



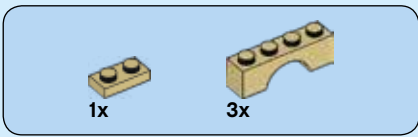

153

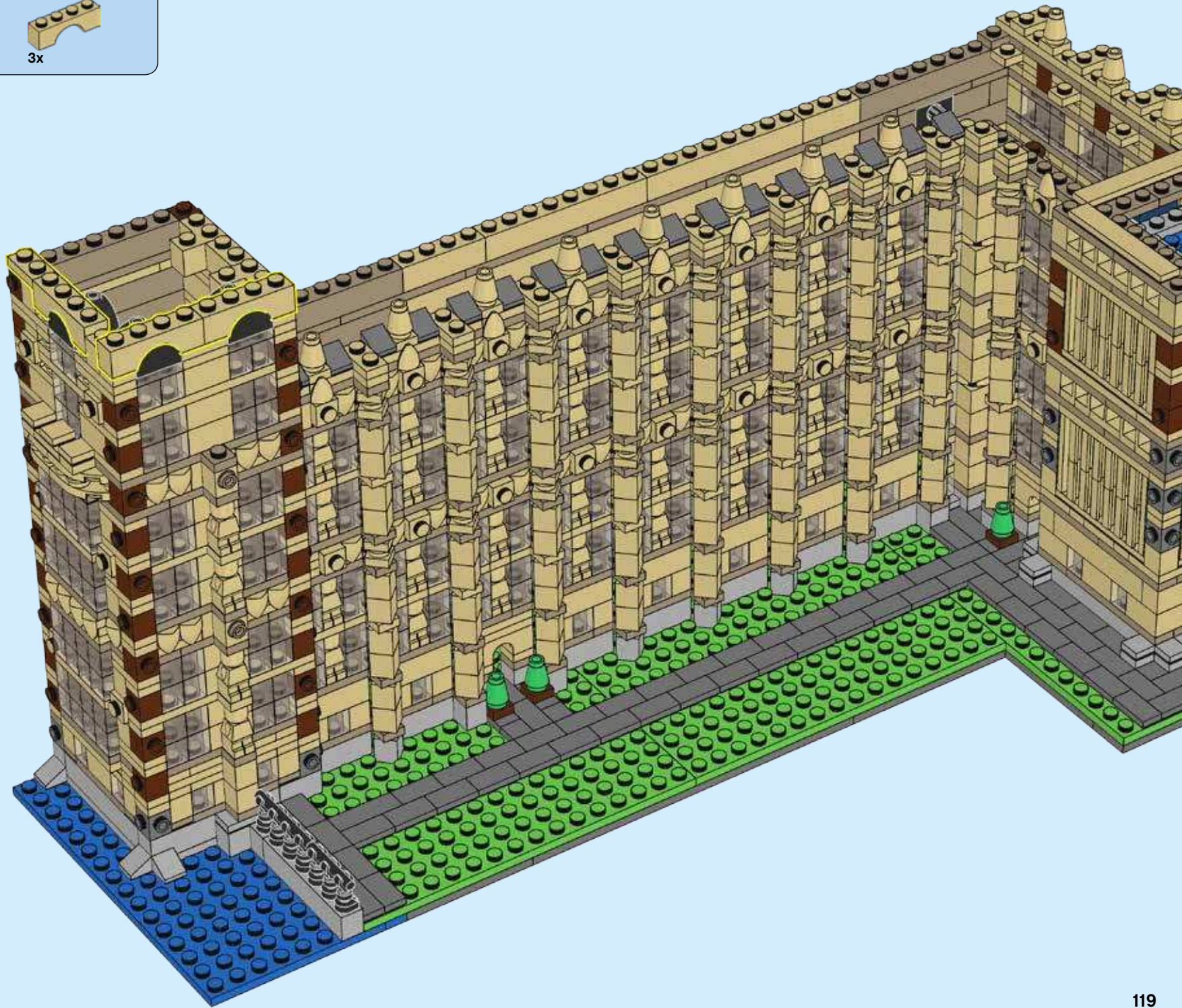

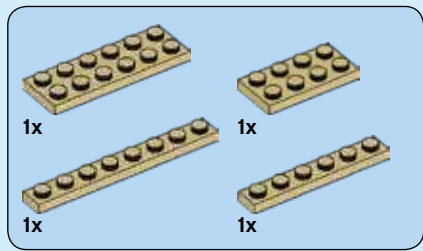

154

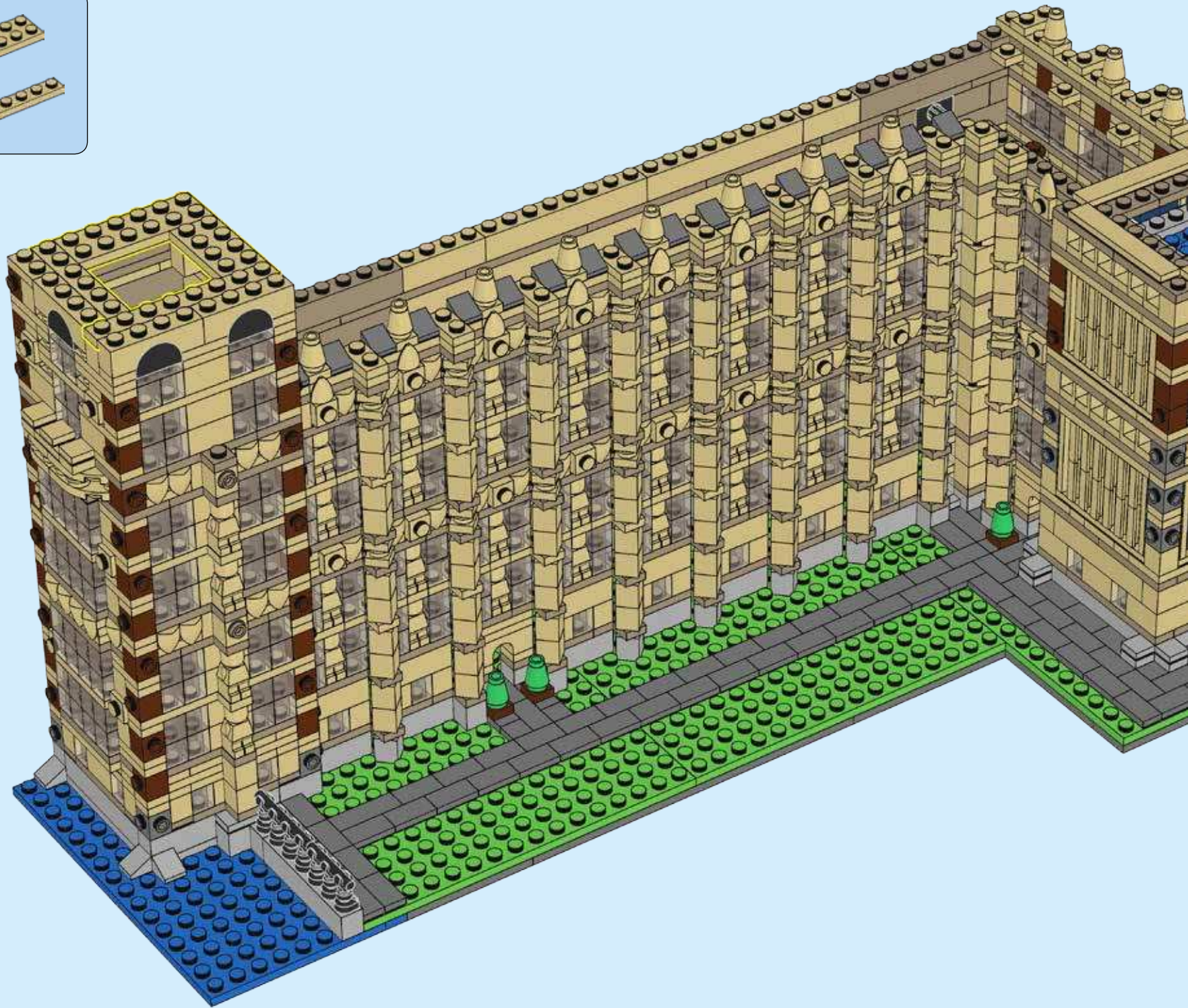

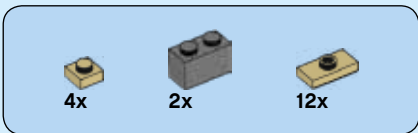

155

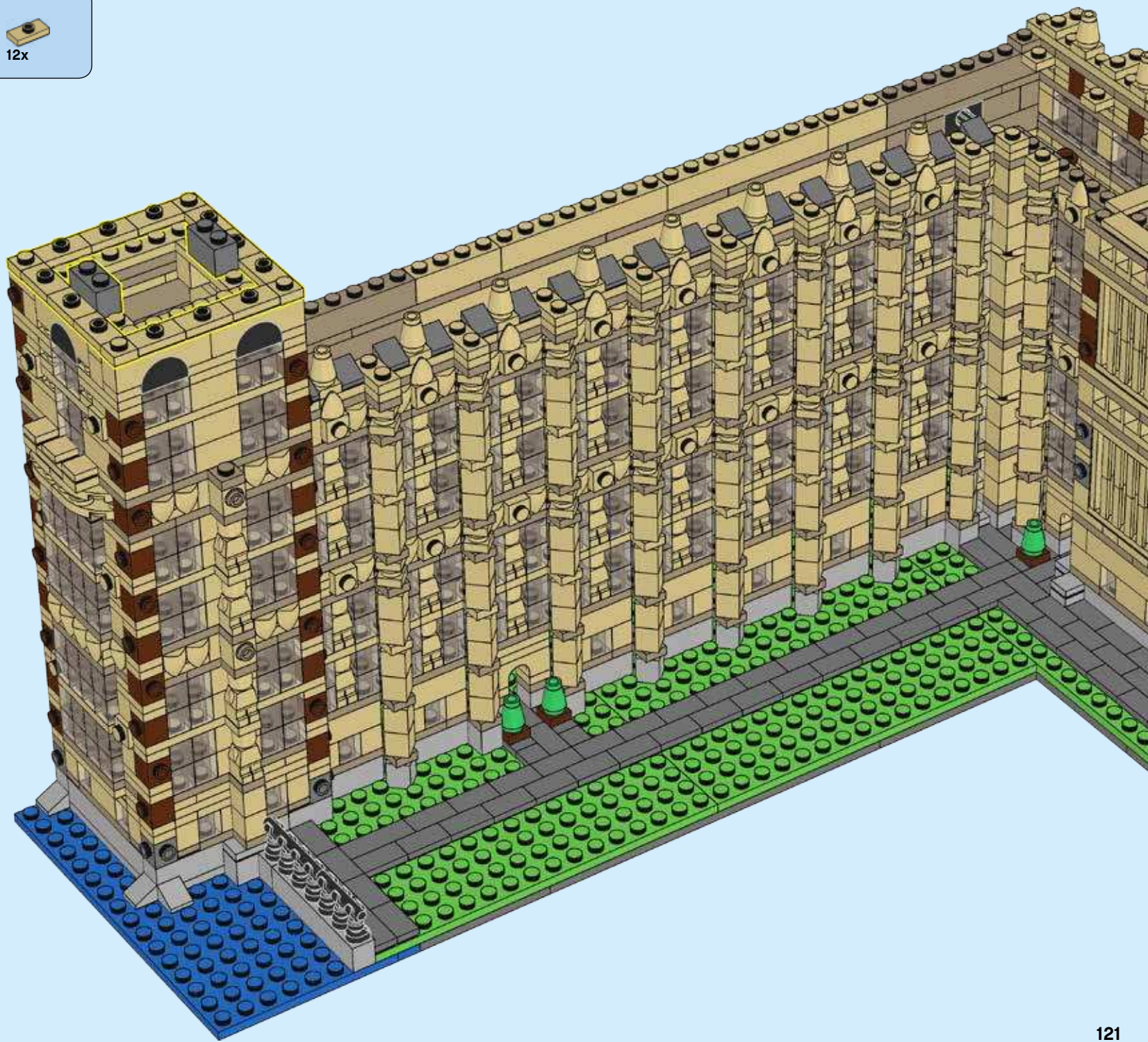

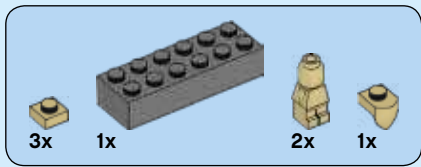

156

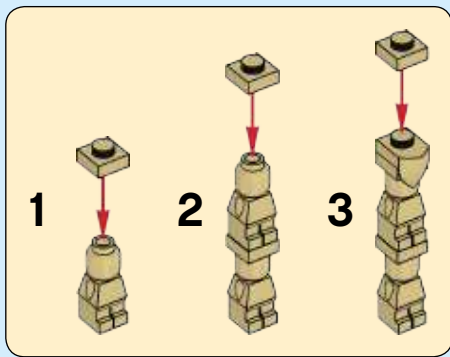

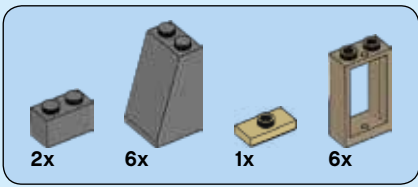

157



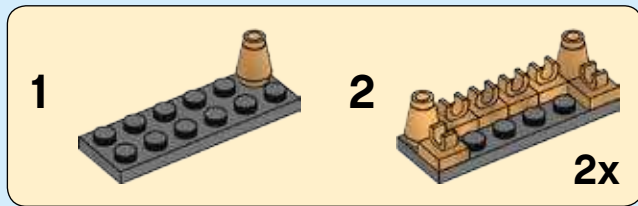
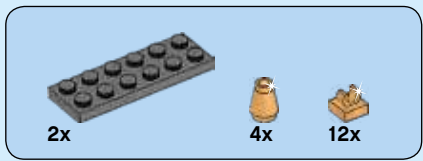

158



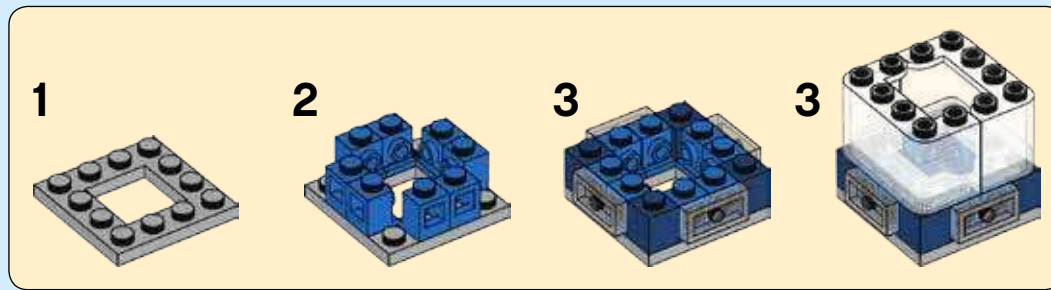
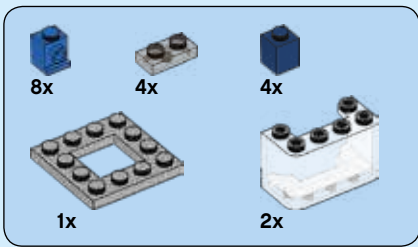

159



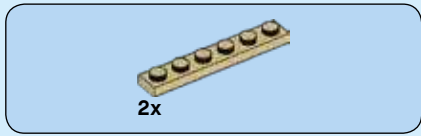

160

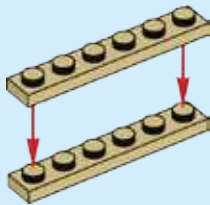

161

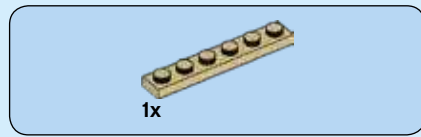
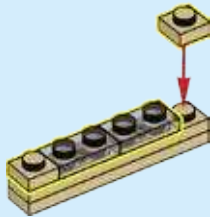

162

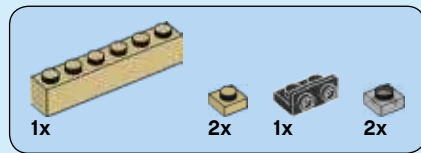
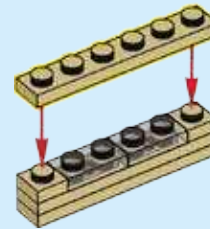

163

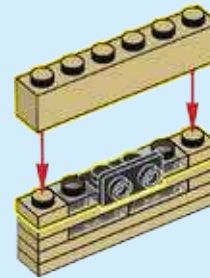

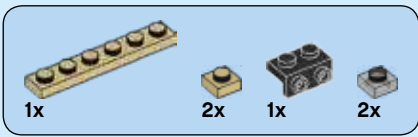

164

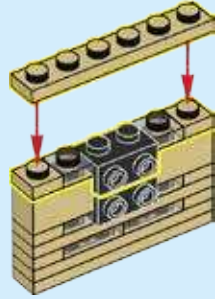

165

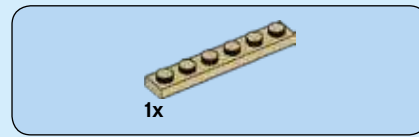
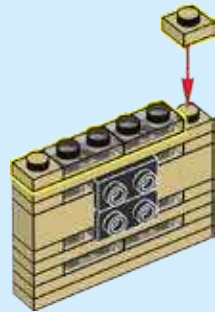

166

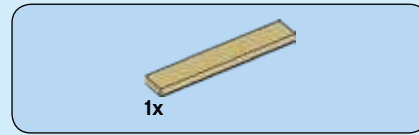
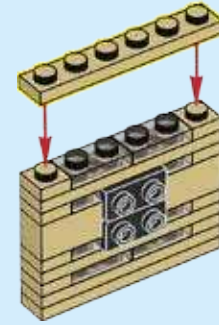

167

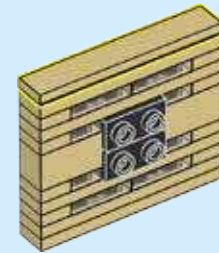

168



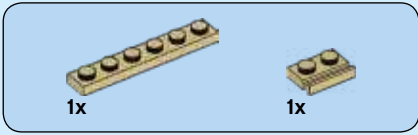

169

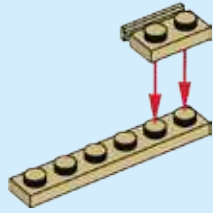

170

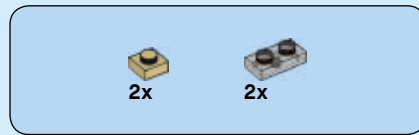
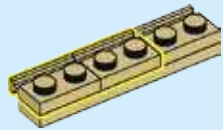

171

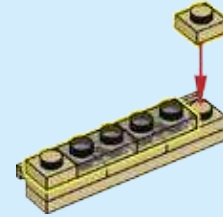

172

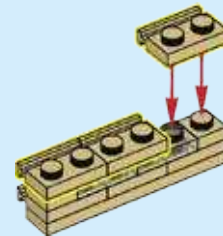



173

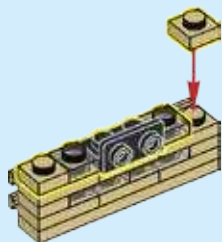

174

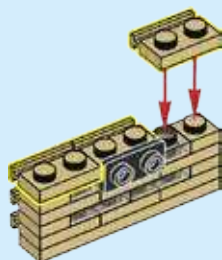

175

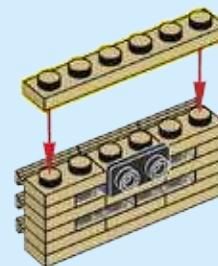

176

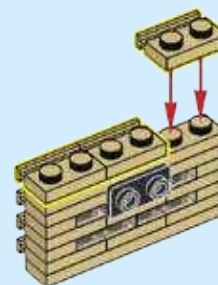

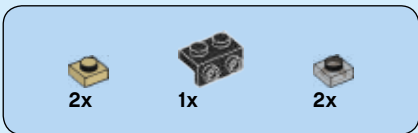

177

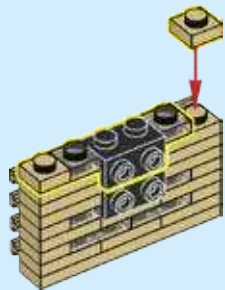

178

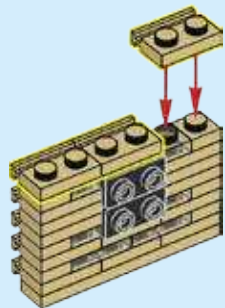

179

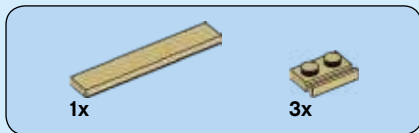
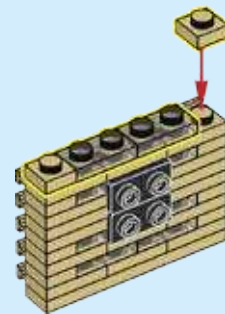

180

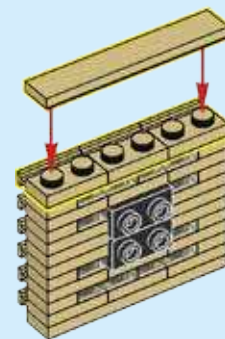

3x

181

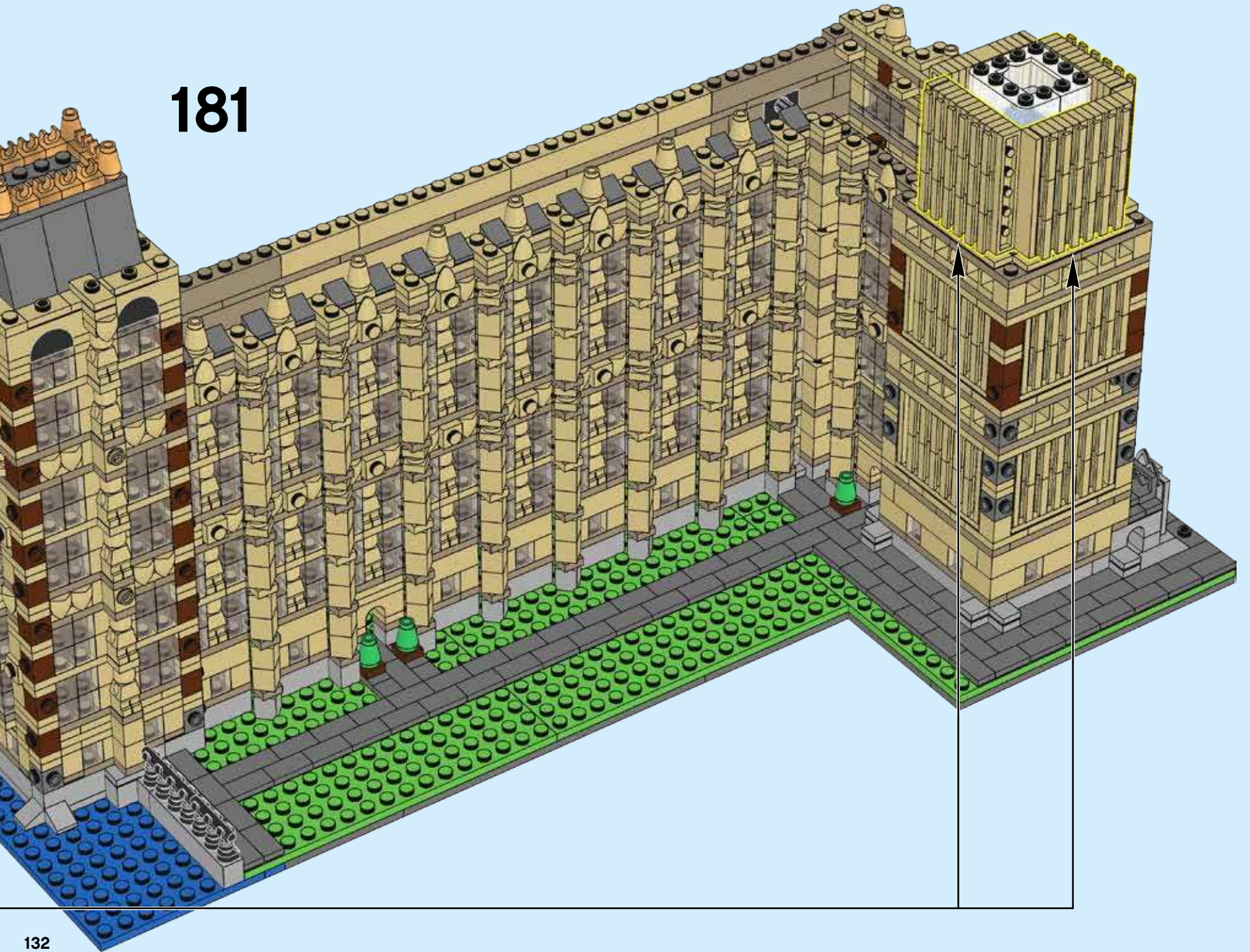

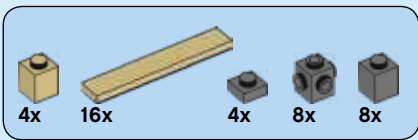

182

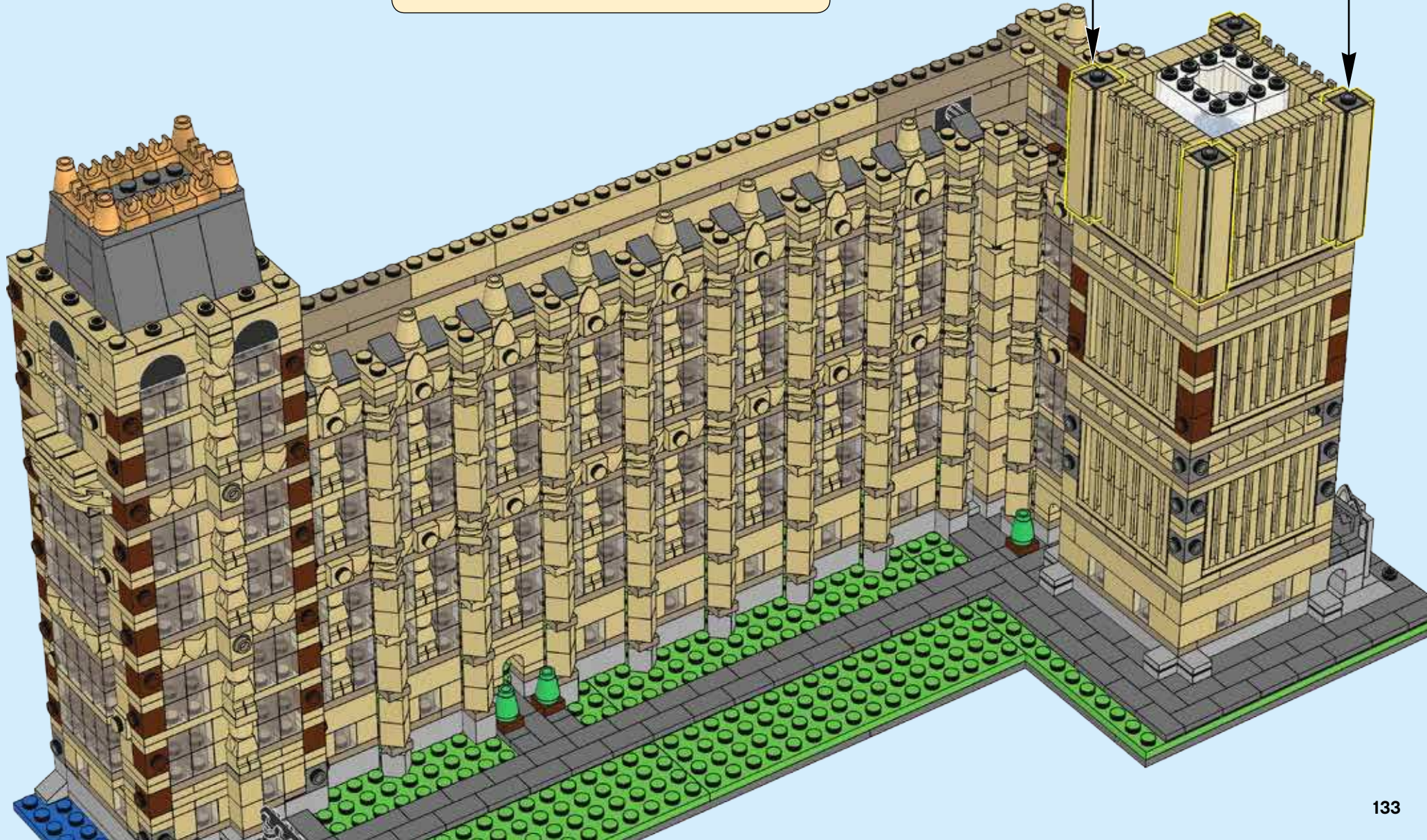
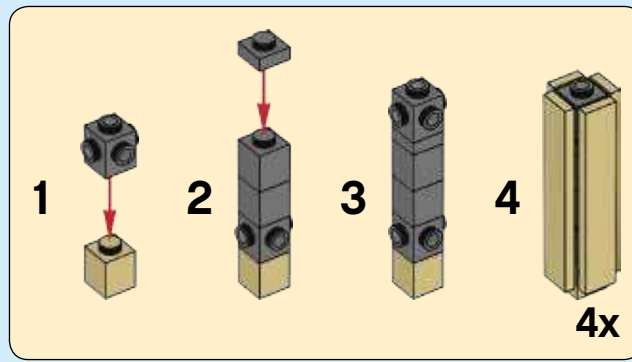

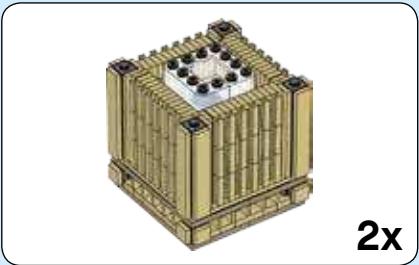
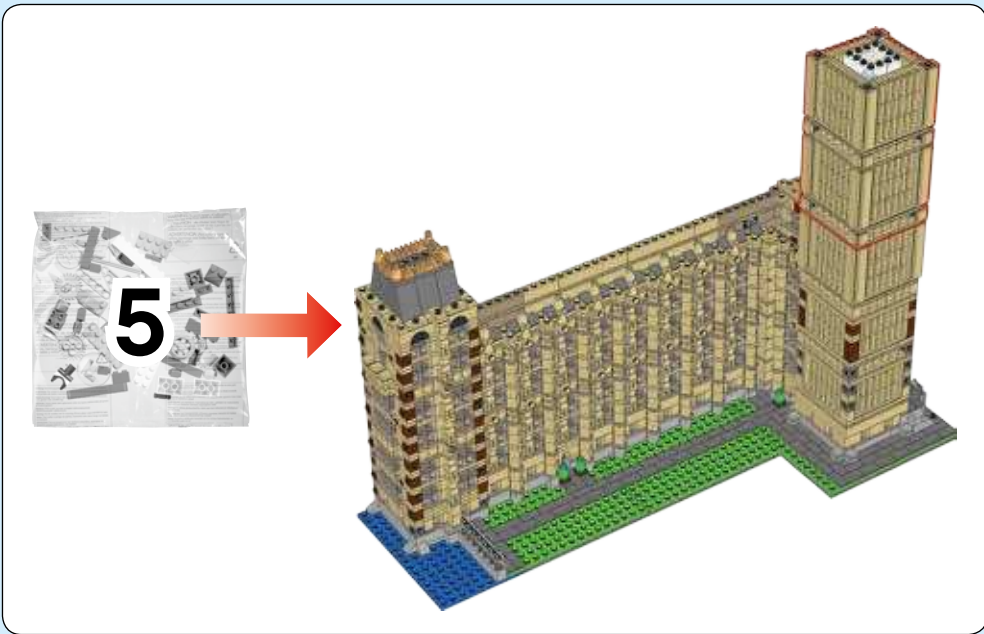

183

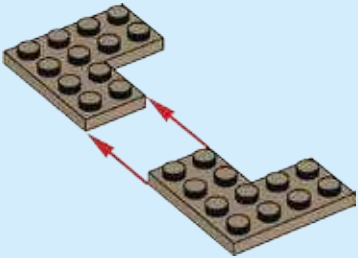

184

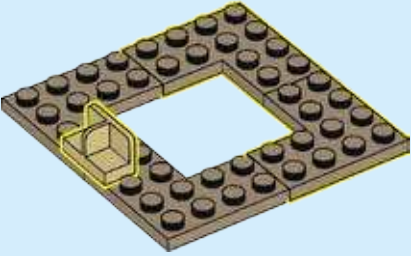

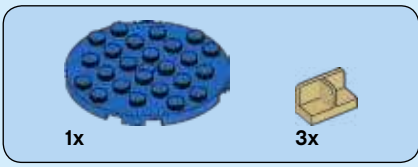

185

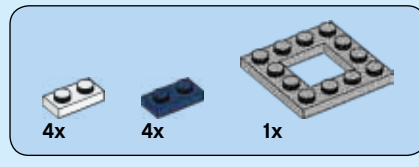
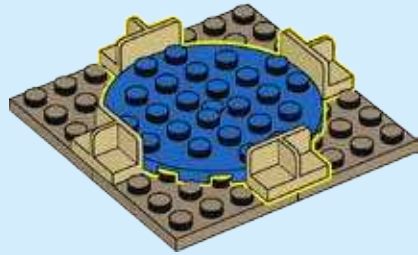

186

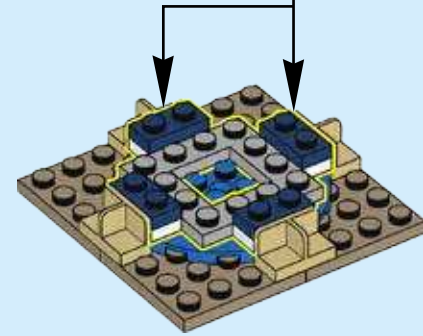
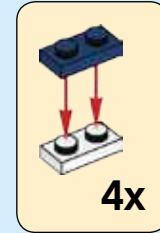



4x



16x

187

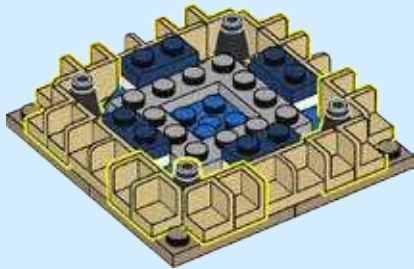

8x



4x

188

1



2



4x

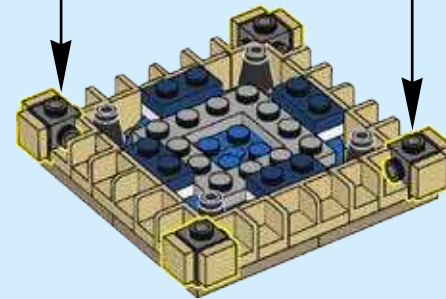



189

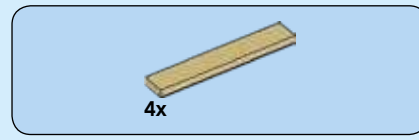
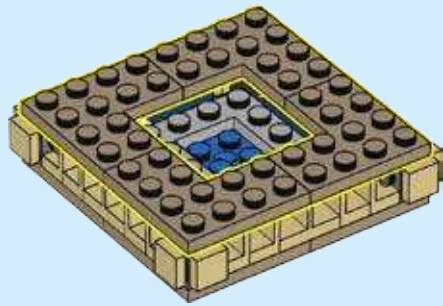

190

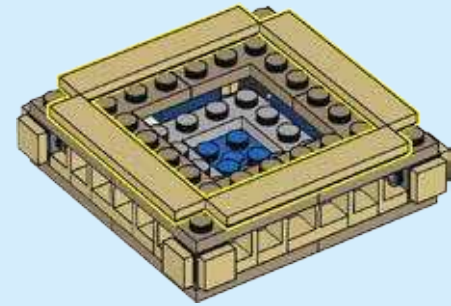

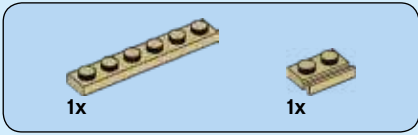

193

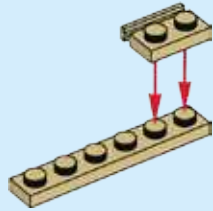

194

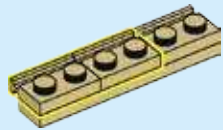

195

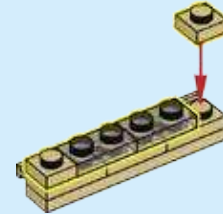

196

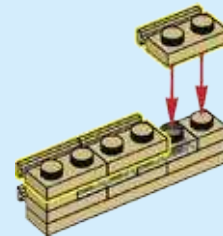



197

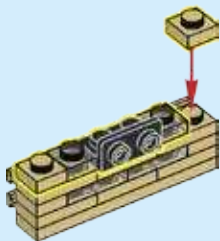

198

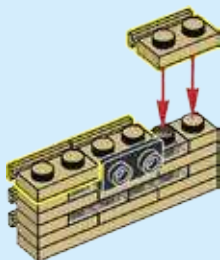

199

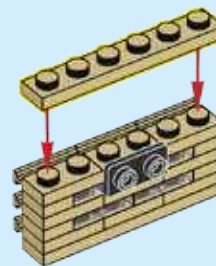

200

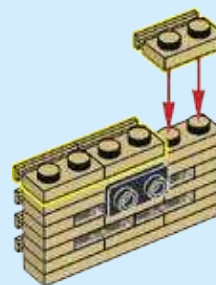

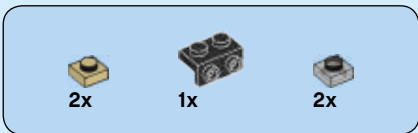

201

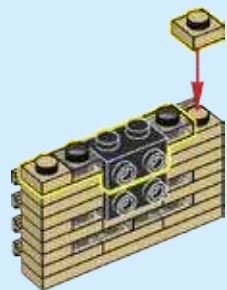

202

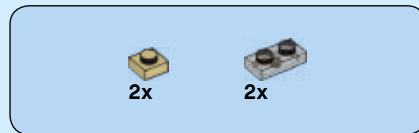
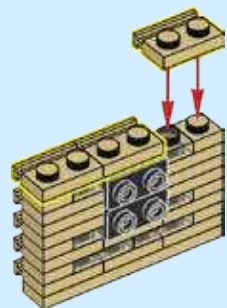

203

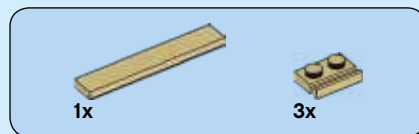
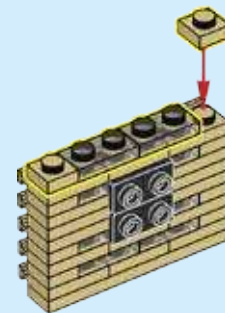

204

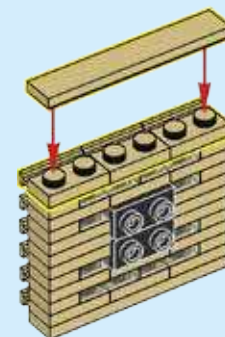

4x

205

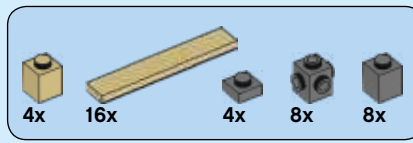
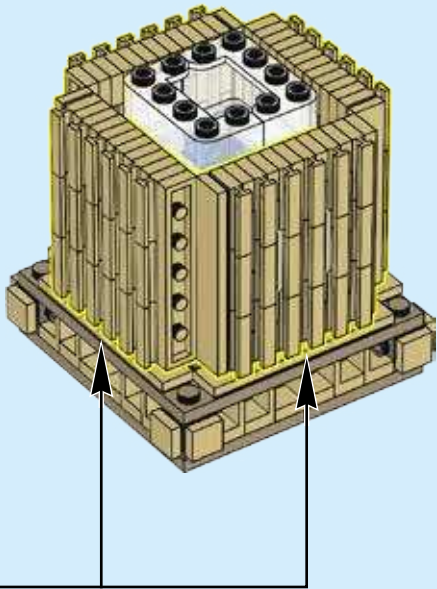

206

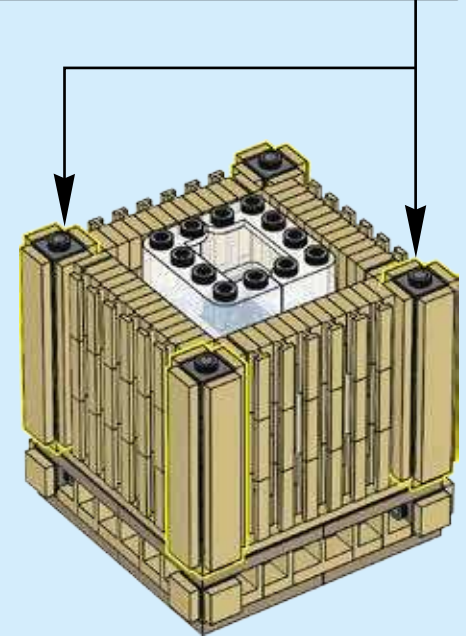
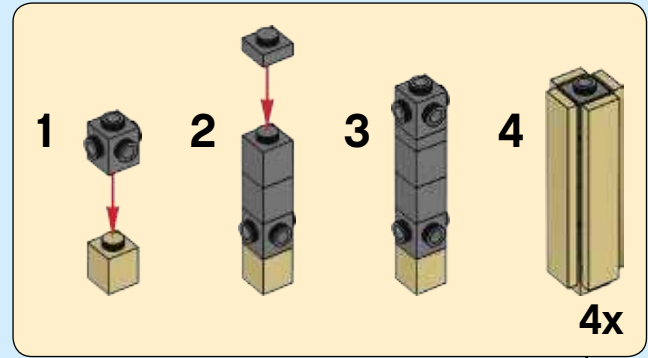

2x

207

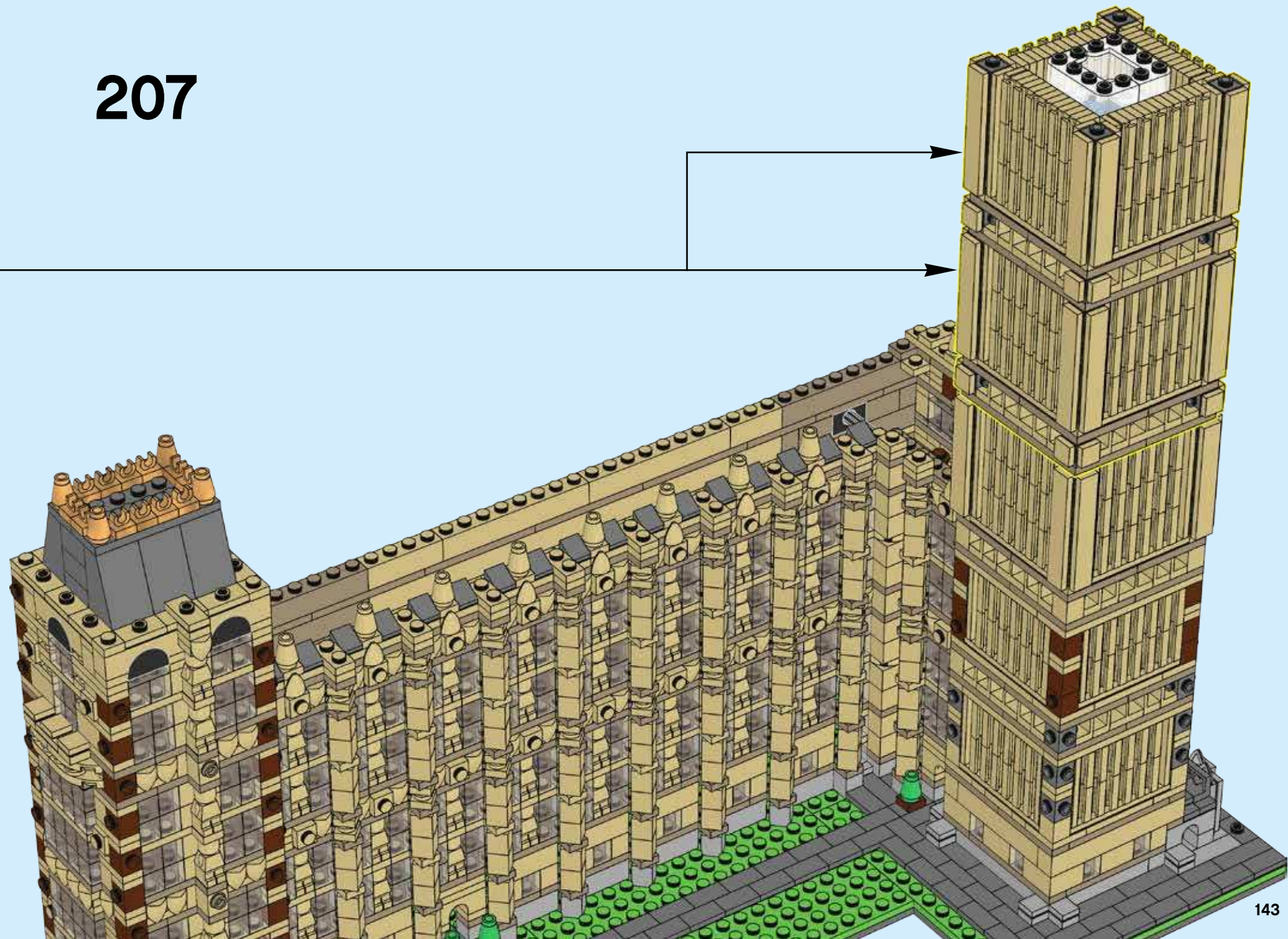

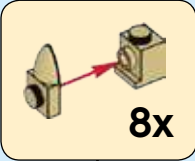
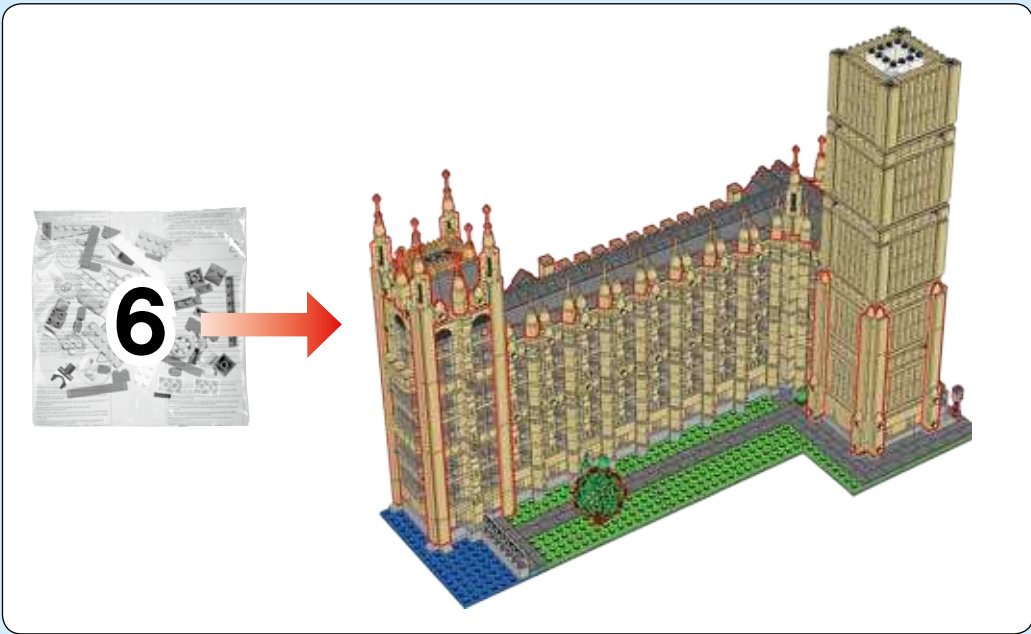

208

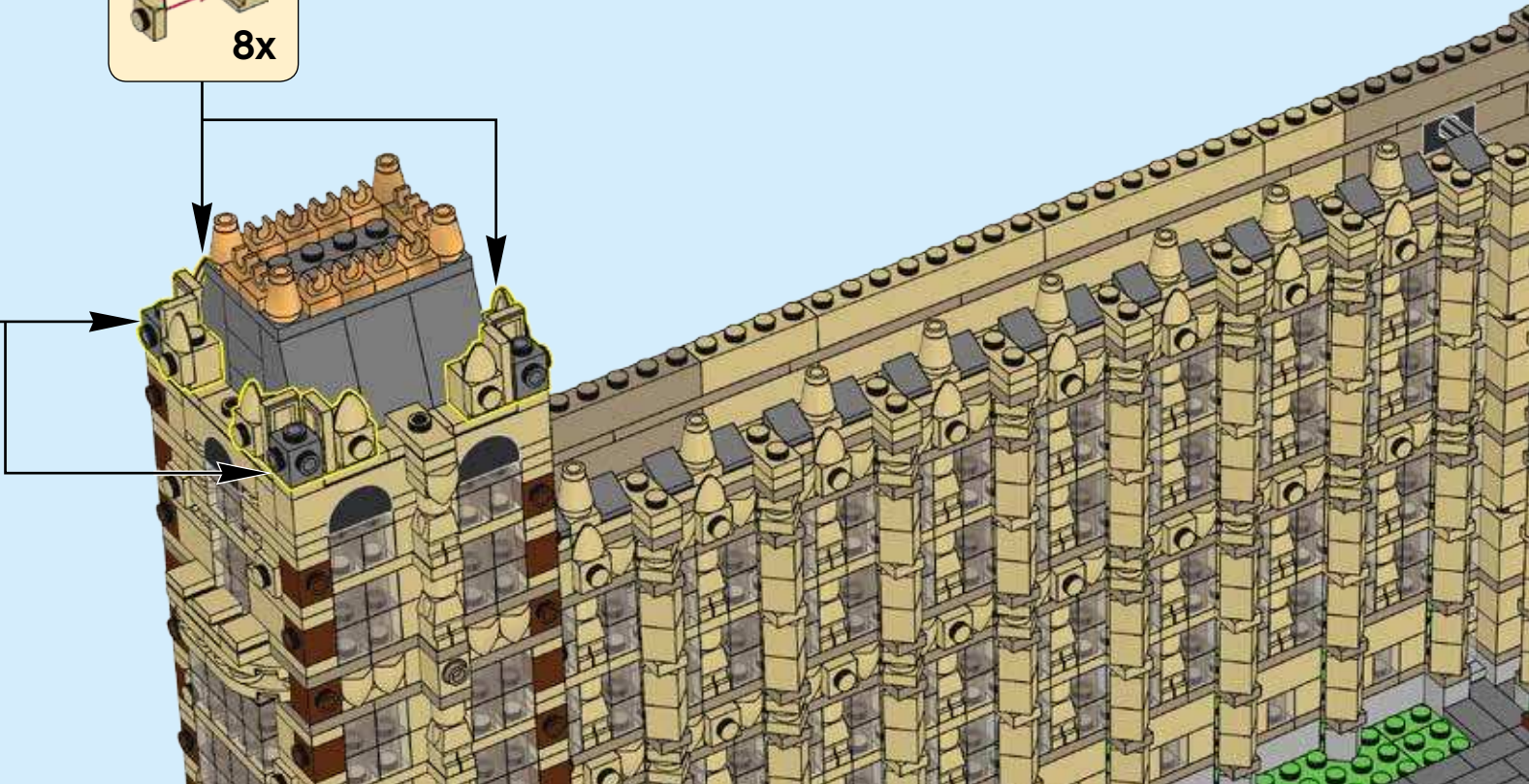
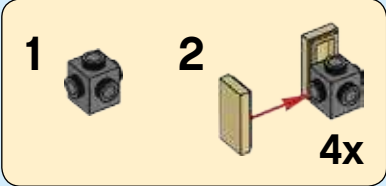

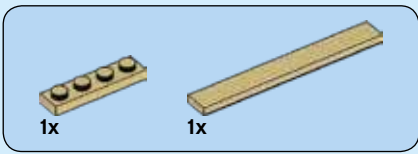

209

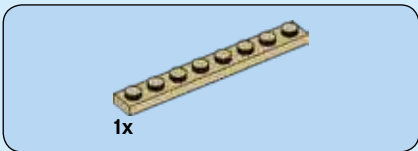
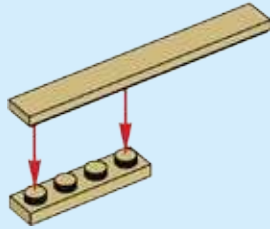

210

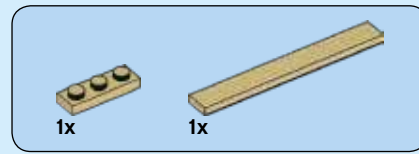
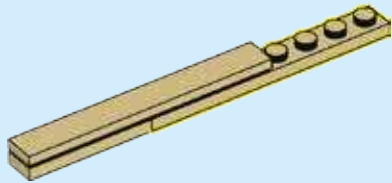

211

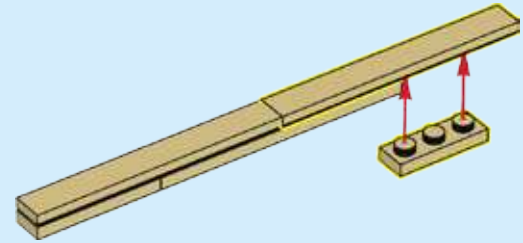

212

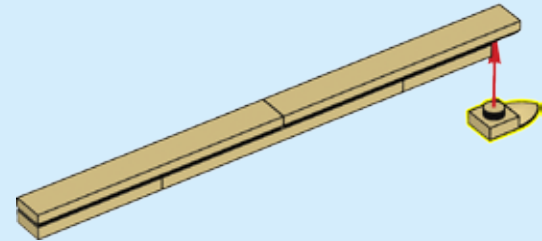

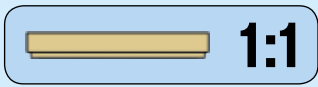
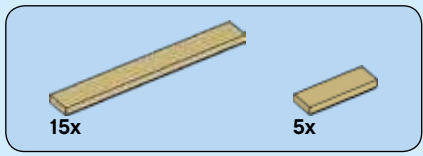

213



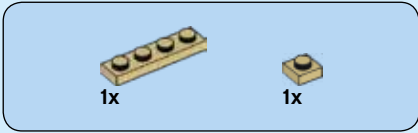

214

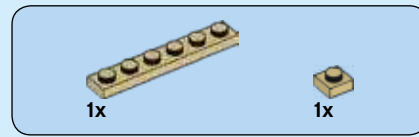
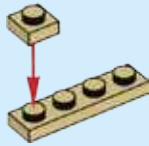

215

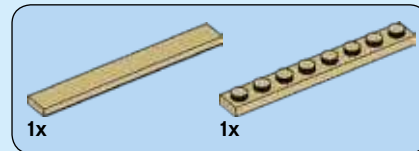
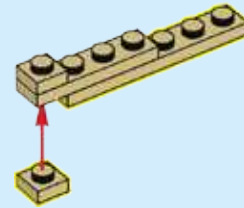

216

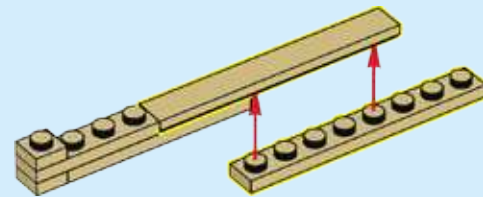

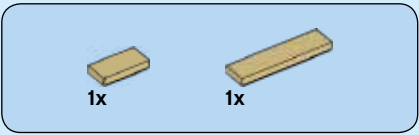

217

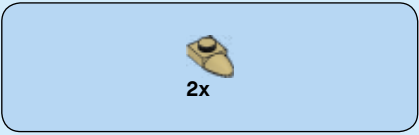
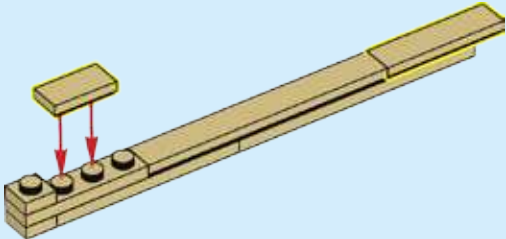

218

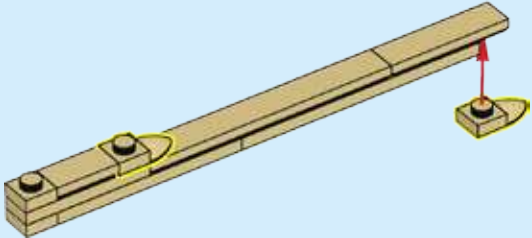

4x

219

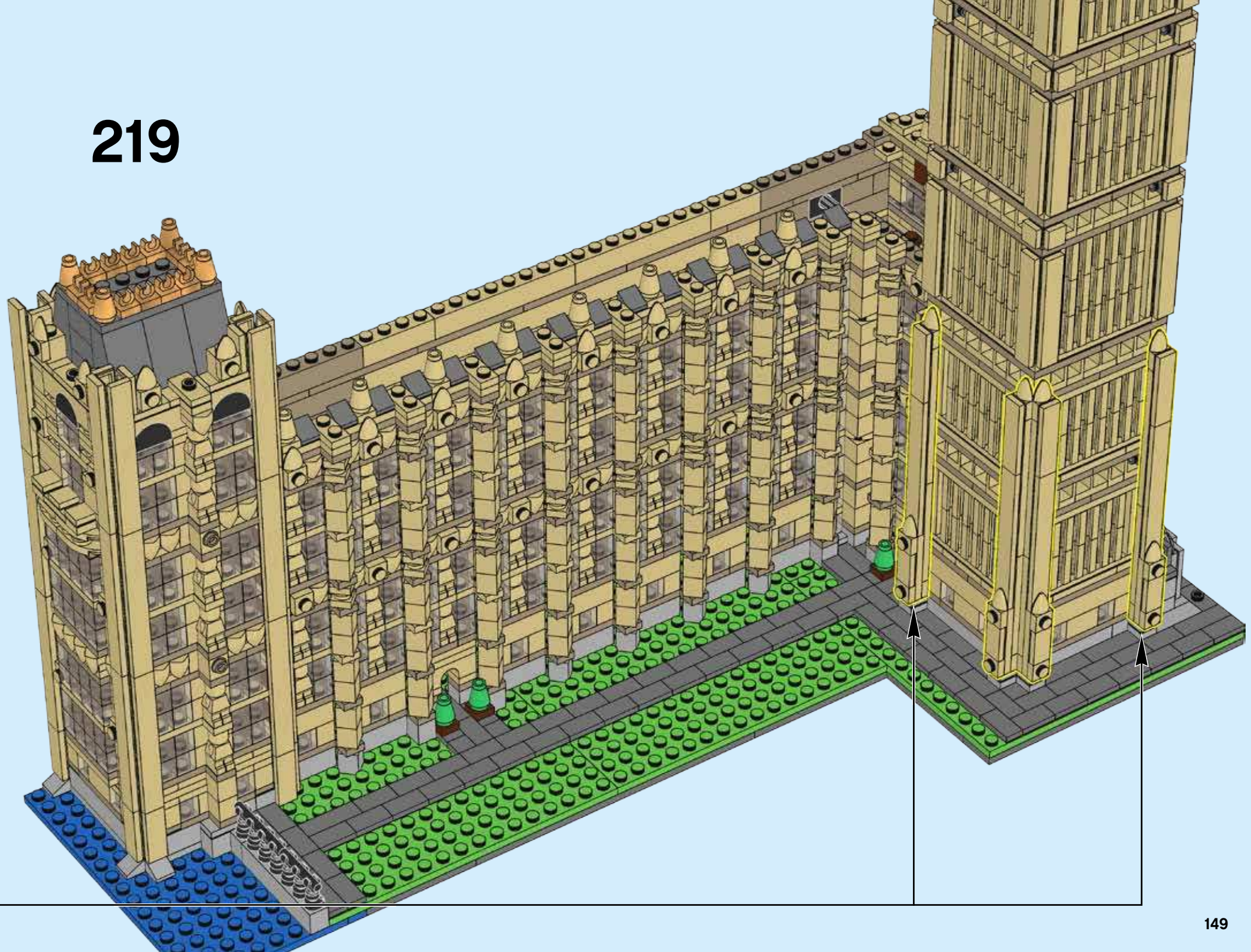

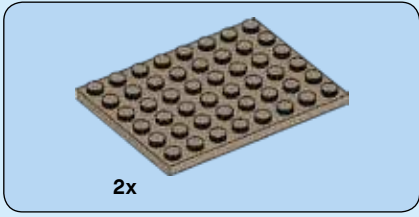
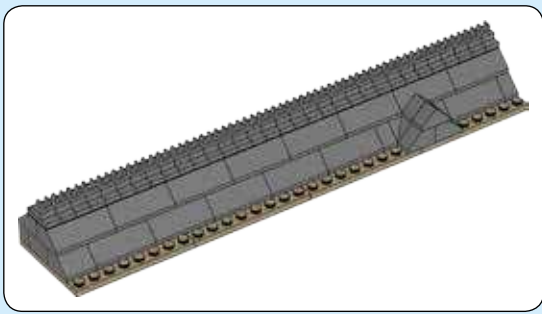

220

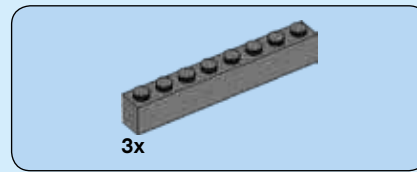
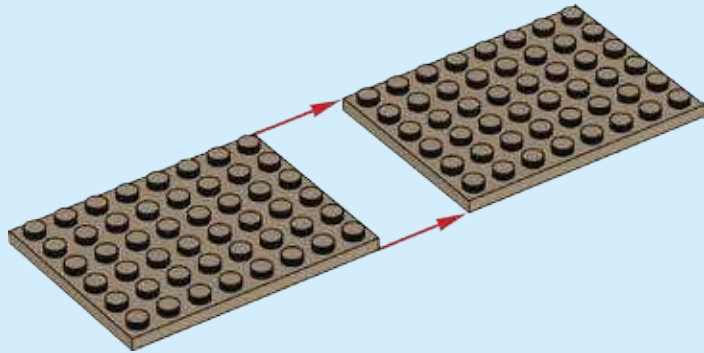

221

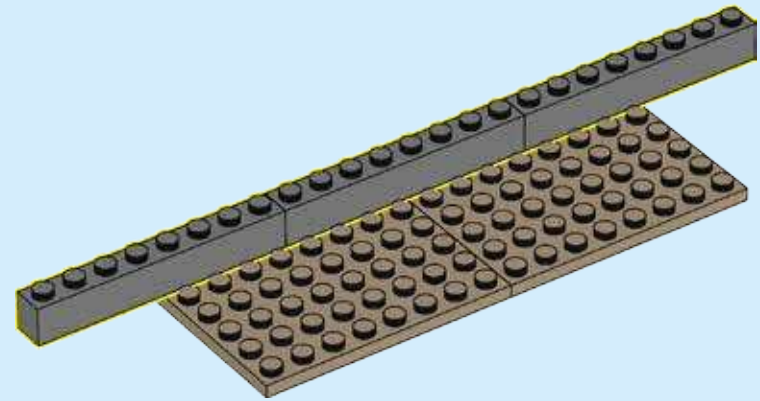

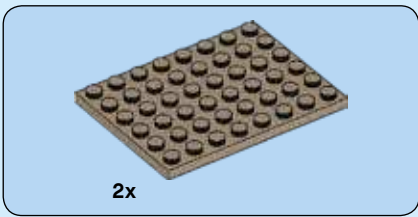

222

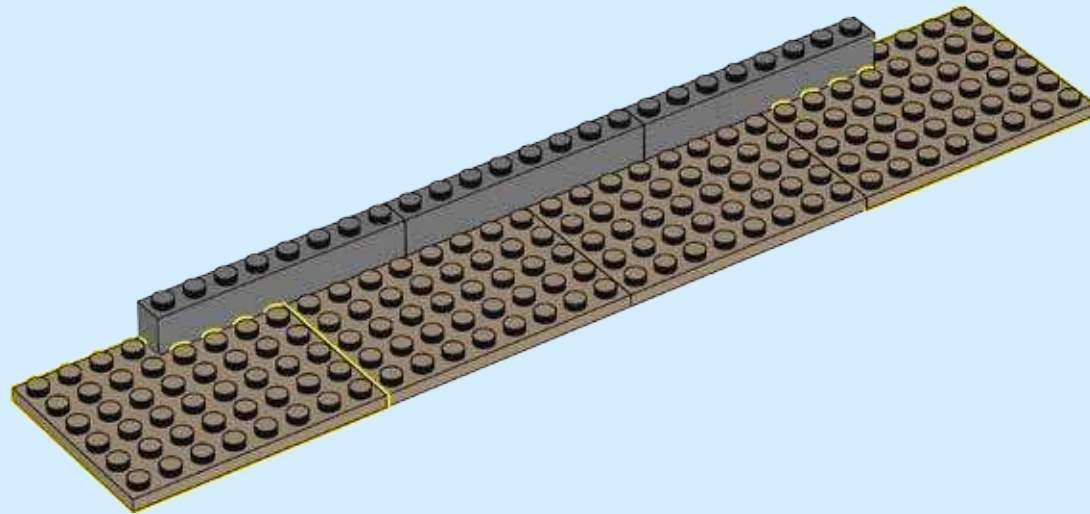

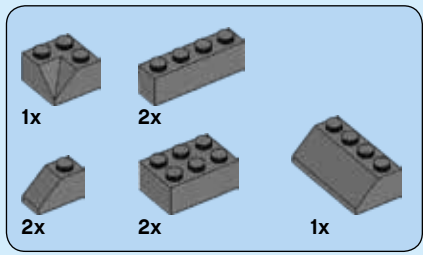

223

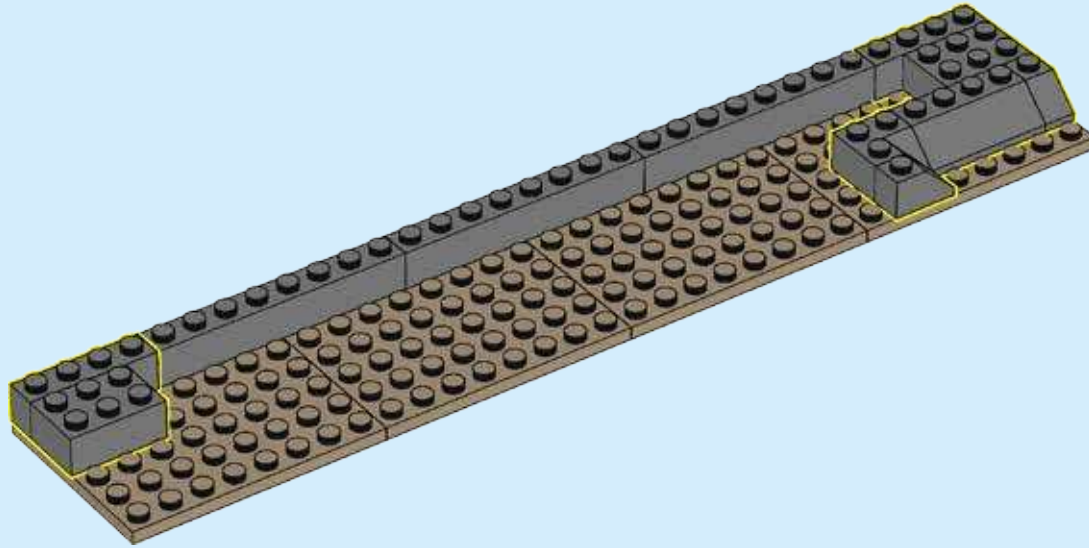

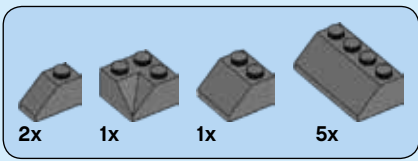

224

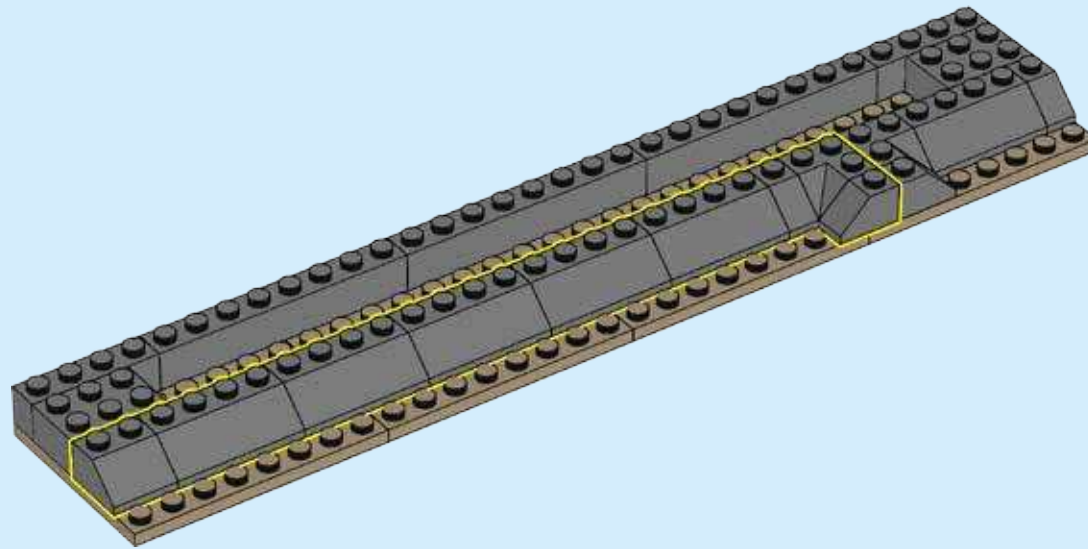

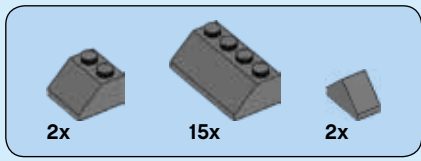

225

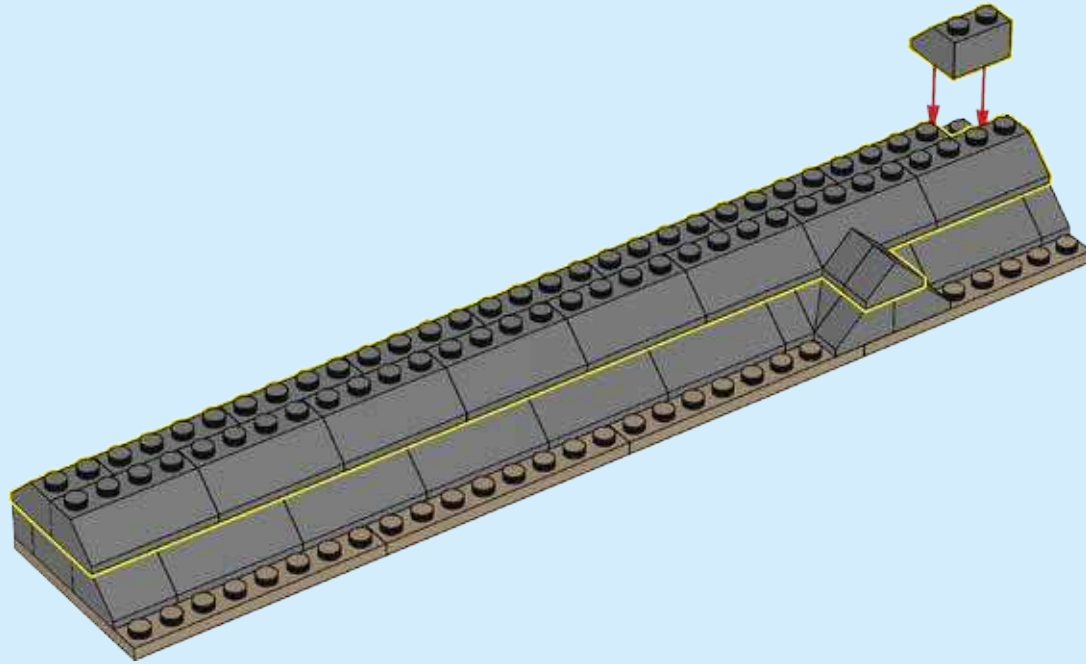



32x

226

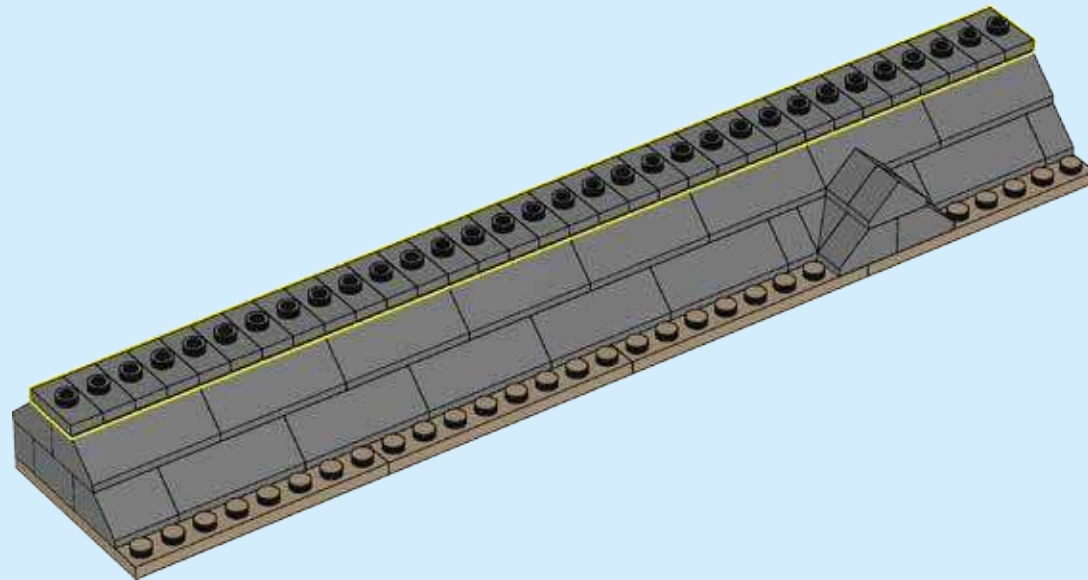



32x

227

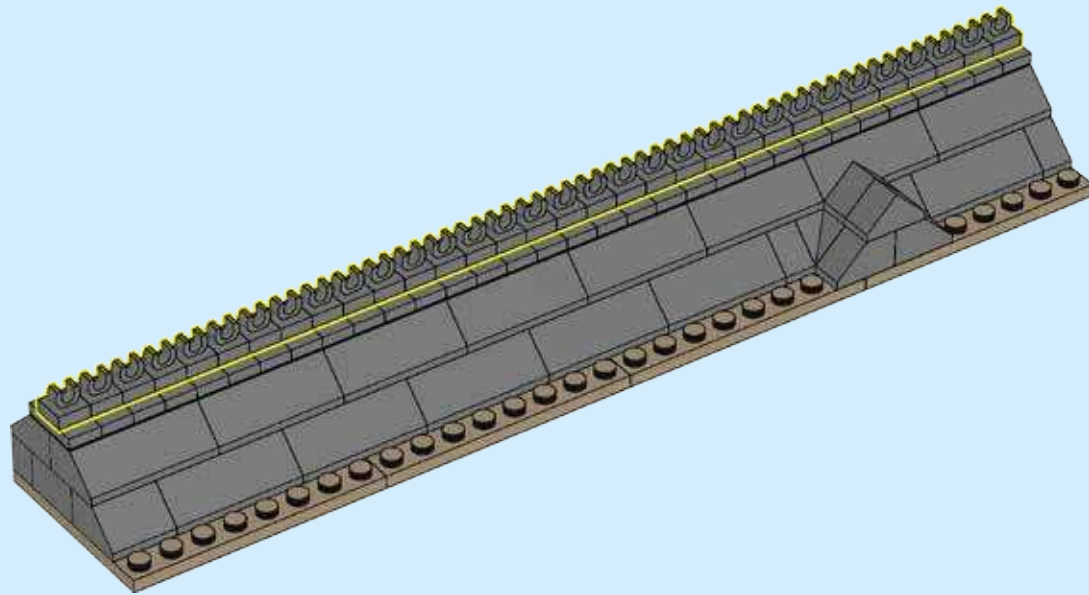

228

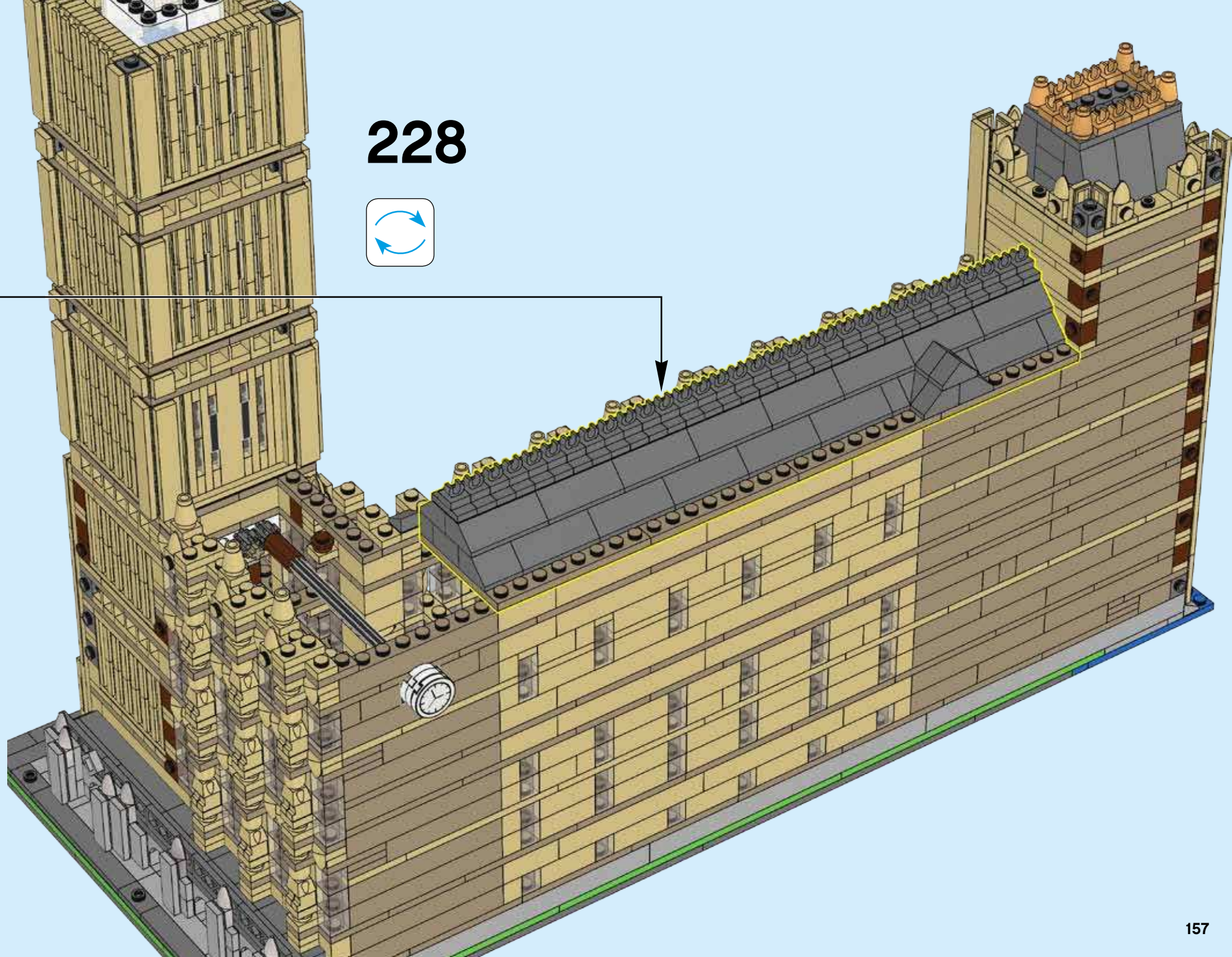
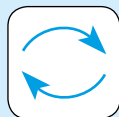

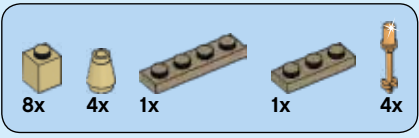

229

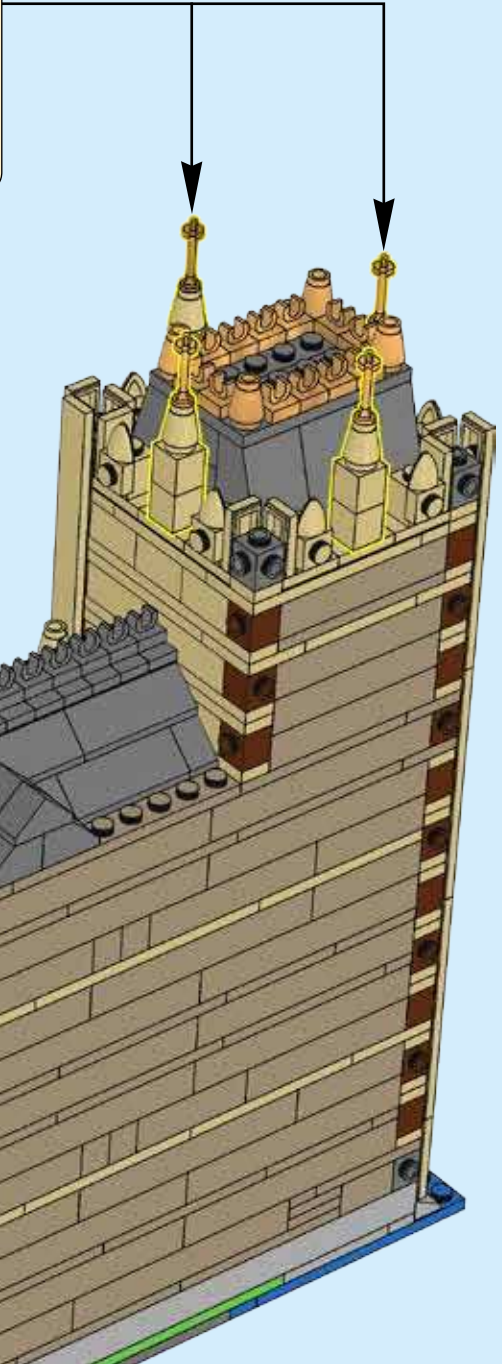
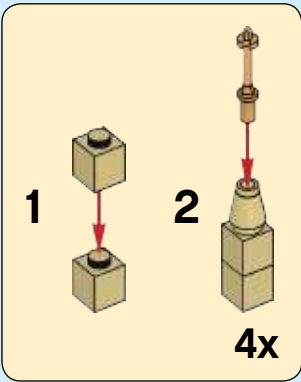

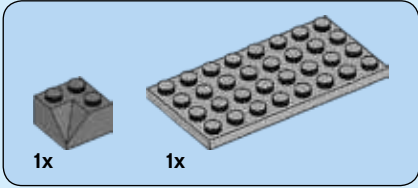
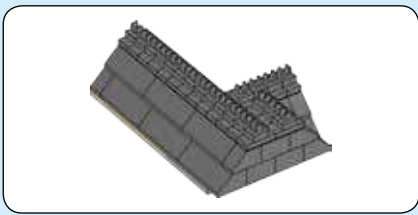

230

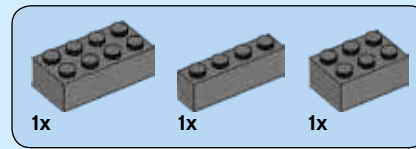
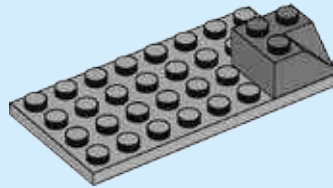

231

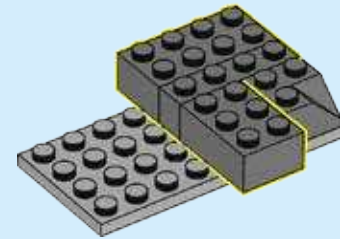

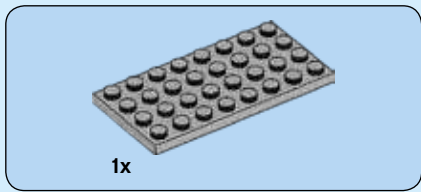

232

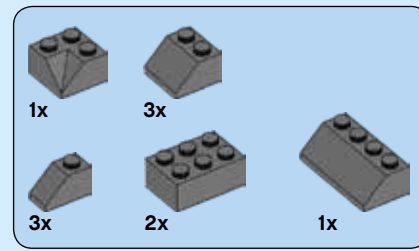
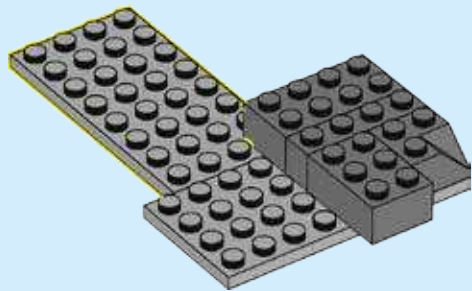

233

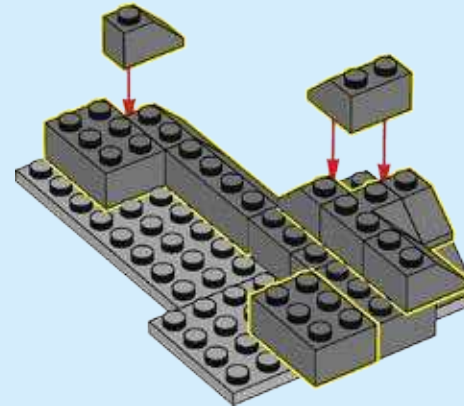



20x

236

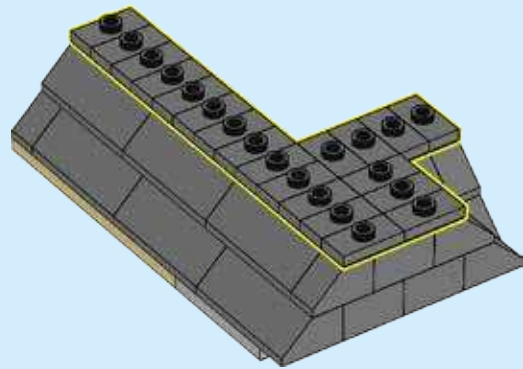

20x

237

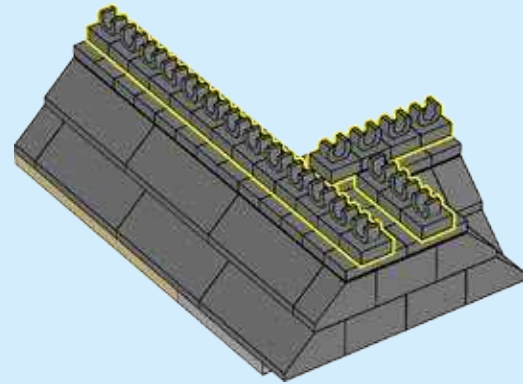

238

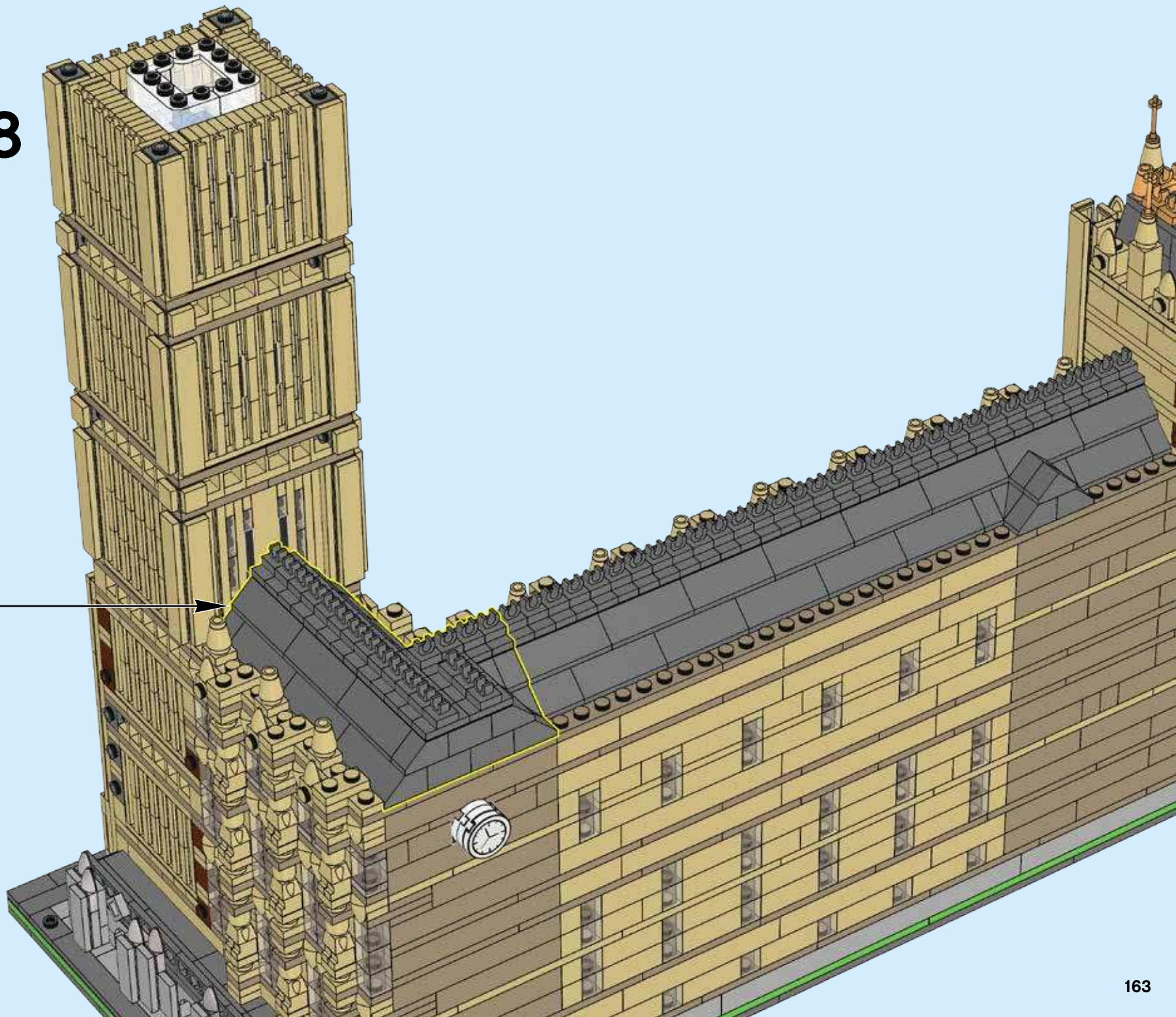

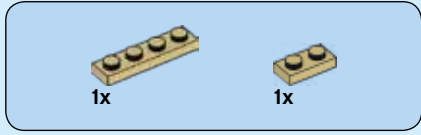
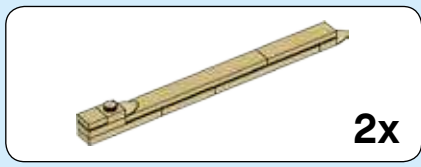

239

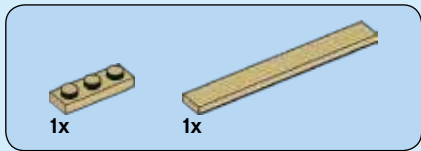
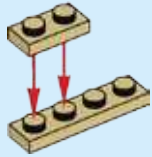

240

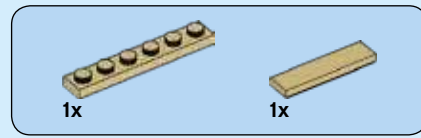
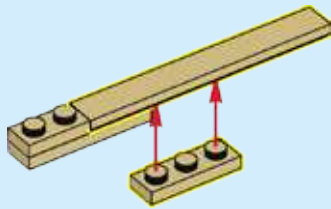

241

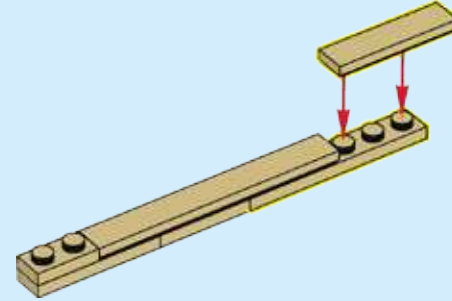

242

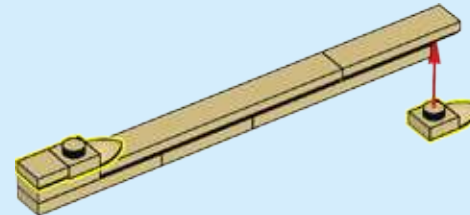

2x

243

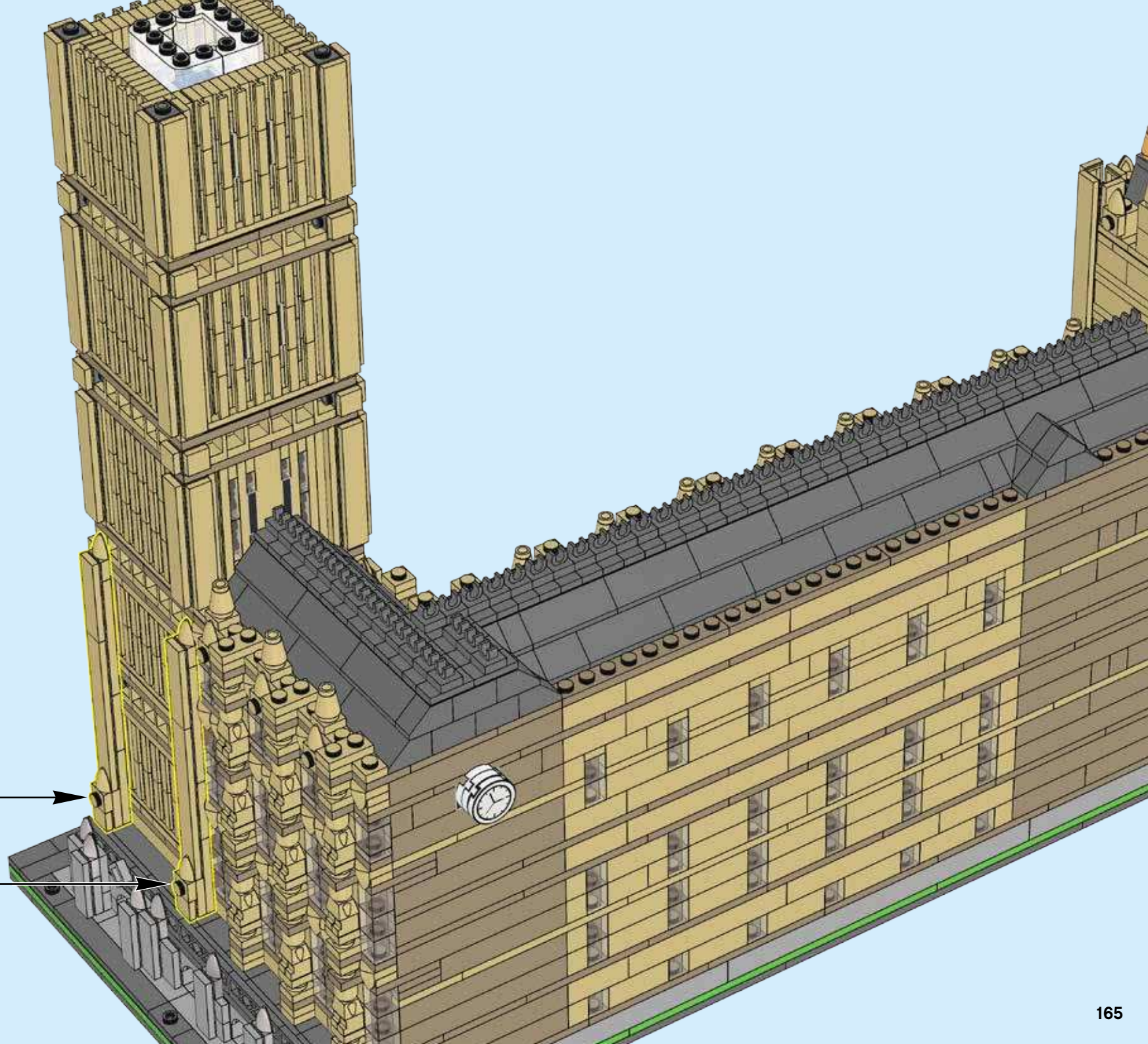

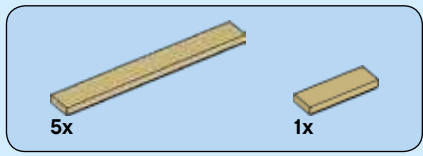

244

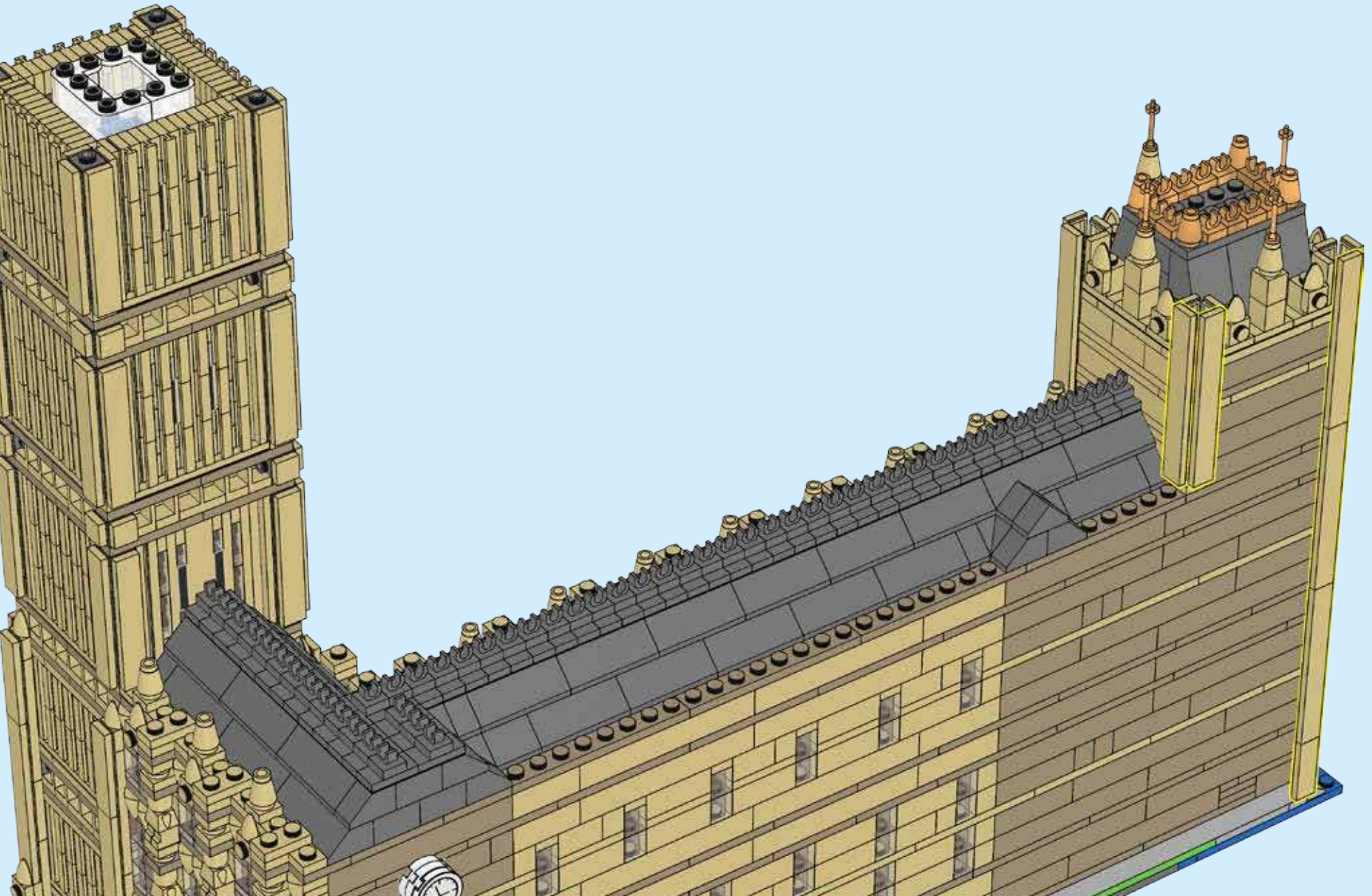

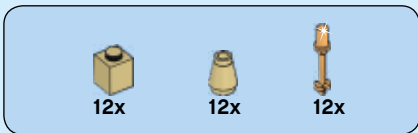

245

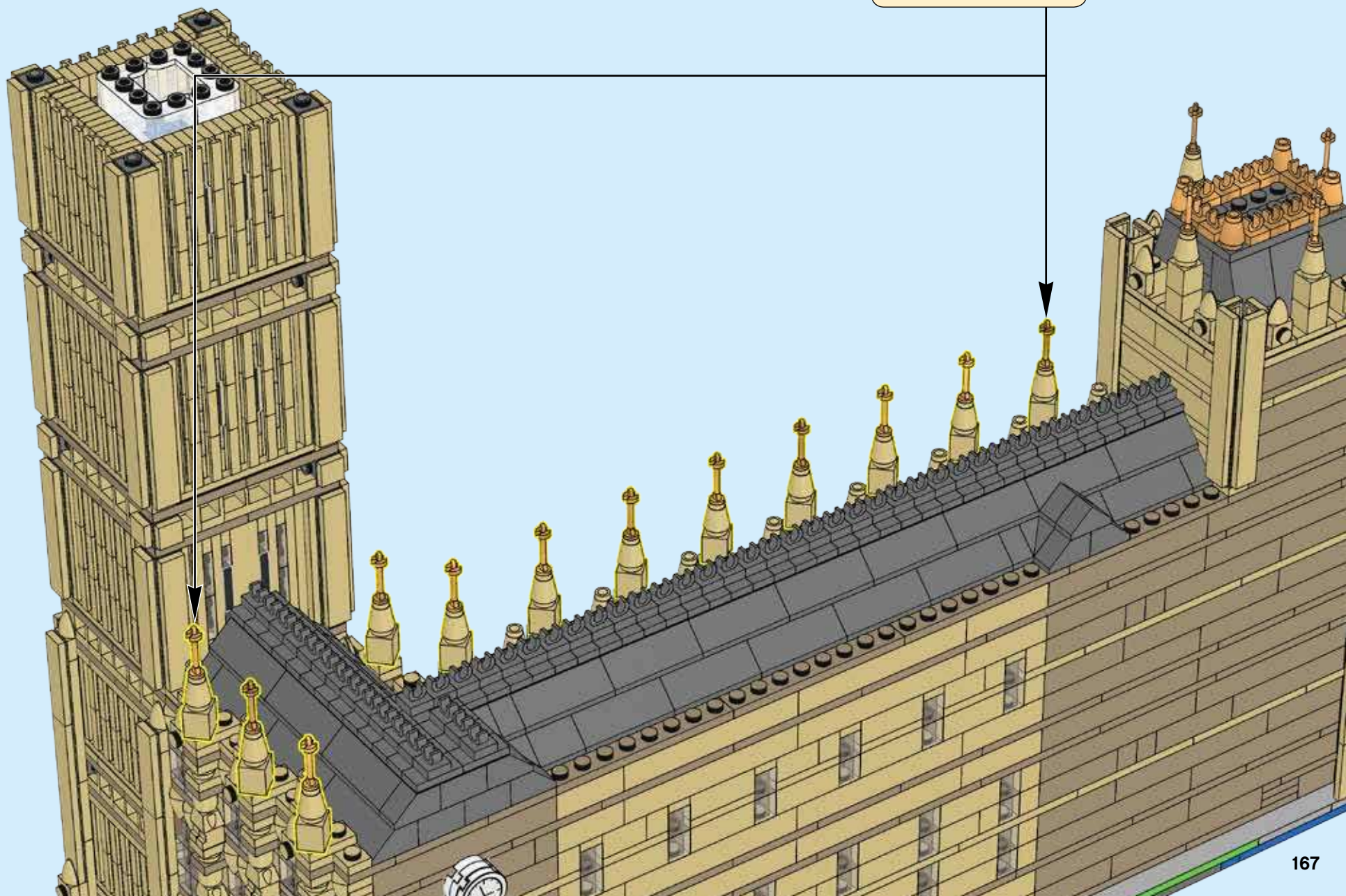
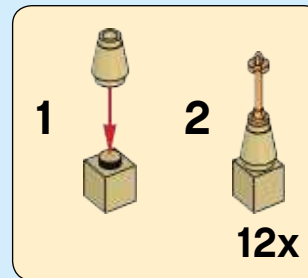

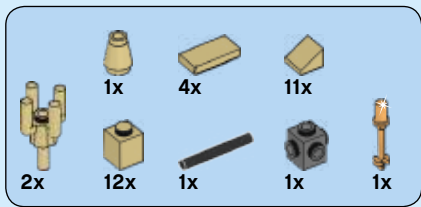

246

1

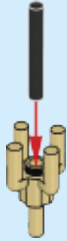

2



3



4



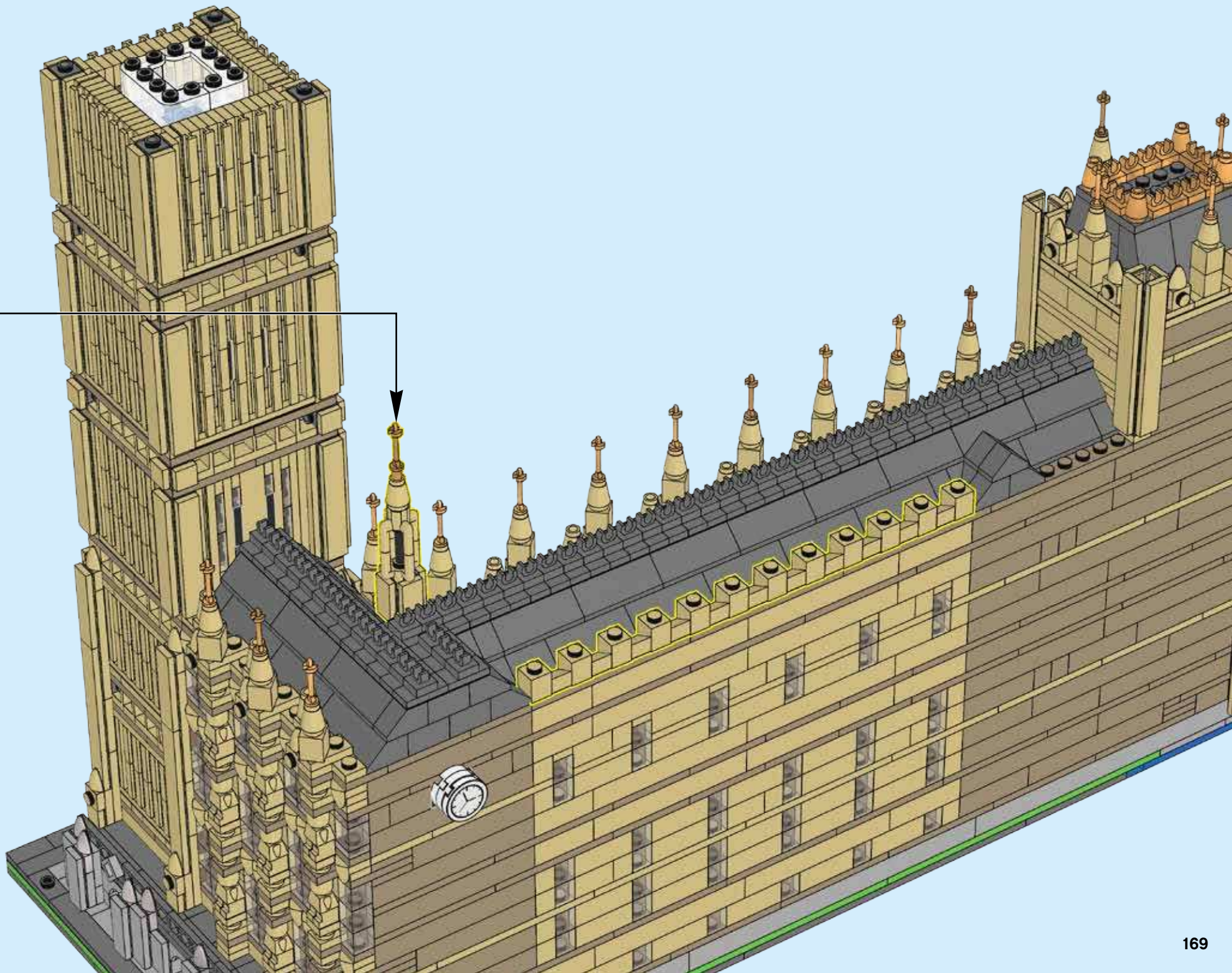

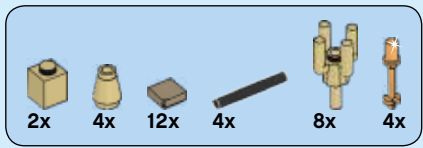

247

1



2



3



4x

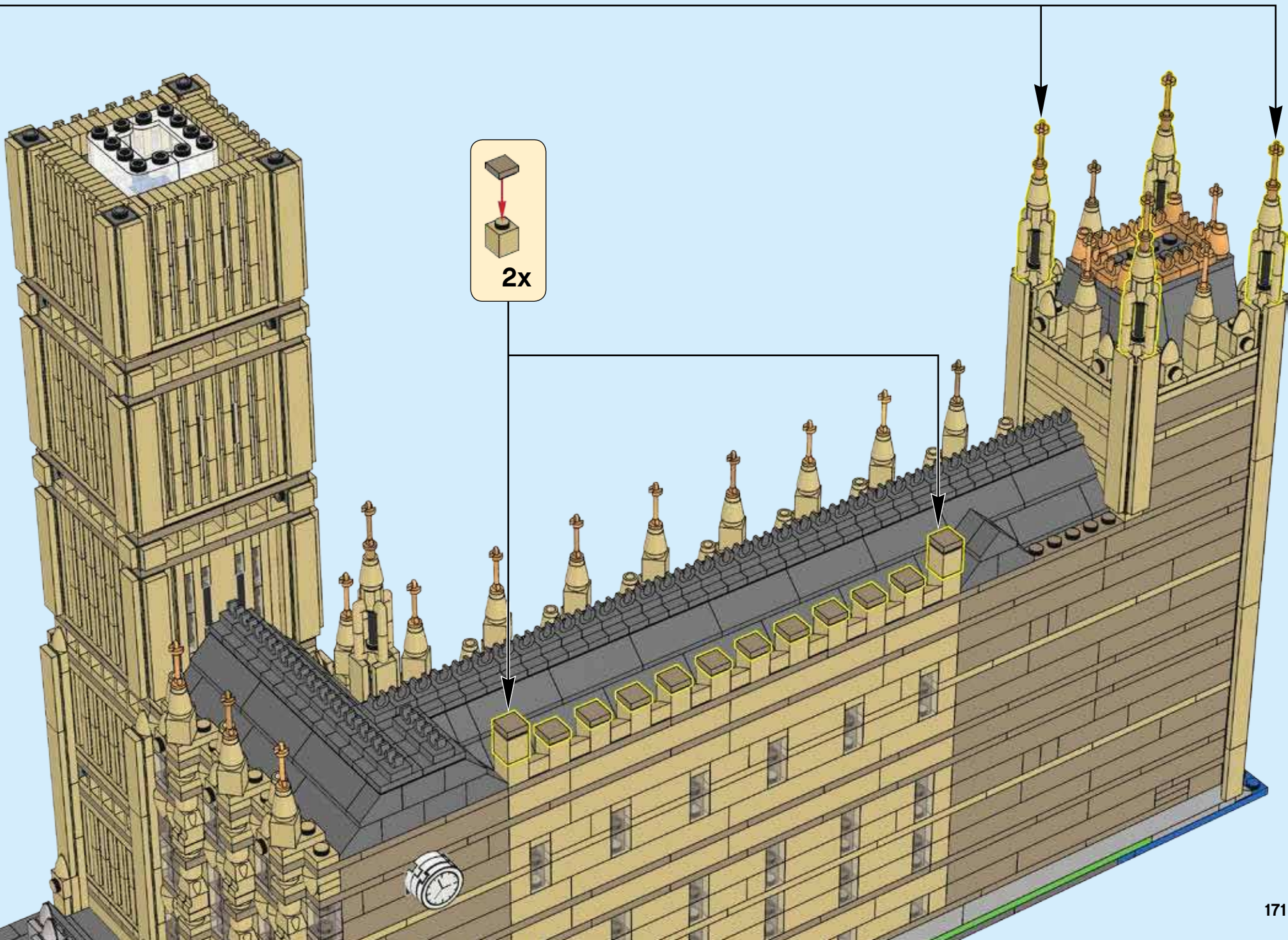

2x



248

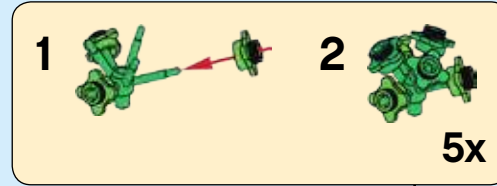

1



2







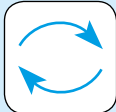
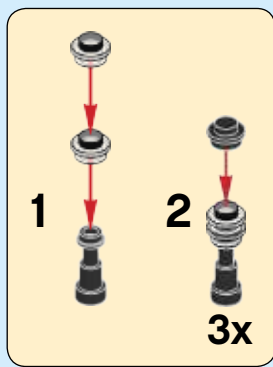

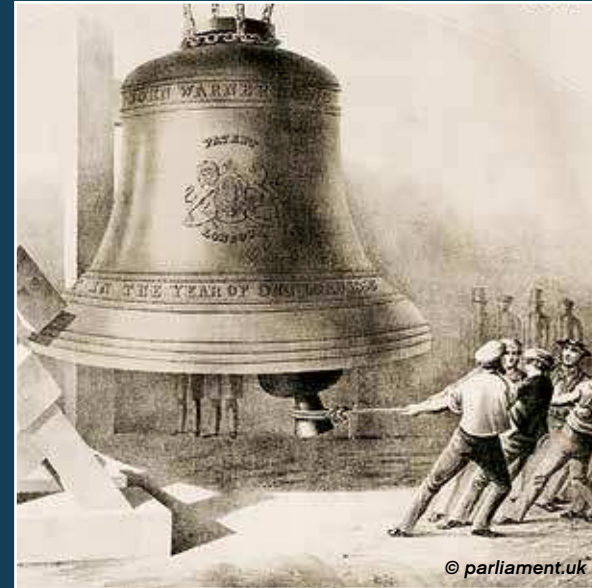
3







-  The first cast of Big Ben cracked and was recast. The second bell also cracked, but was repaired and is still in use today.
-  Der erste Guss von Big Ben bekam Risse und wurde somit erneut gegossen. Die zweite Glocke erlitt ebenfalls einen Riss, doch sie wurde repariert und ist noch heute in Gebrauch.
-  Le premier moule de Big Ben se fendit et fut reconstruit. La deuxième cloche se fissa également, mais fut réparée et est toujours utilisée aujourd'hui.
-  Cuando se fundió por primera vez, la campana conocida como Big Ben se agrietó y fue preciso volver a fundirla. La segunda campana también se agrietó, pero fue reparada y aún se encuentra en uso en la actualidad.
-  O primeiro molde do Big Ben rachou e teve de voltar a ser fundido. O segundo também rachou, mas foi reparado e continua atualmente em uso.
-  A Big Ben első öntésekor megrepedt, ezért újra kellett önteni. A második harang is megrepedt, de azt kijavították és a mai napig használatban van.





+



4x

32

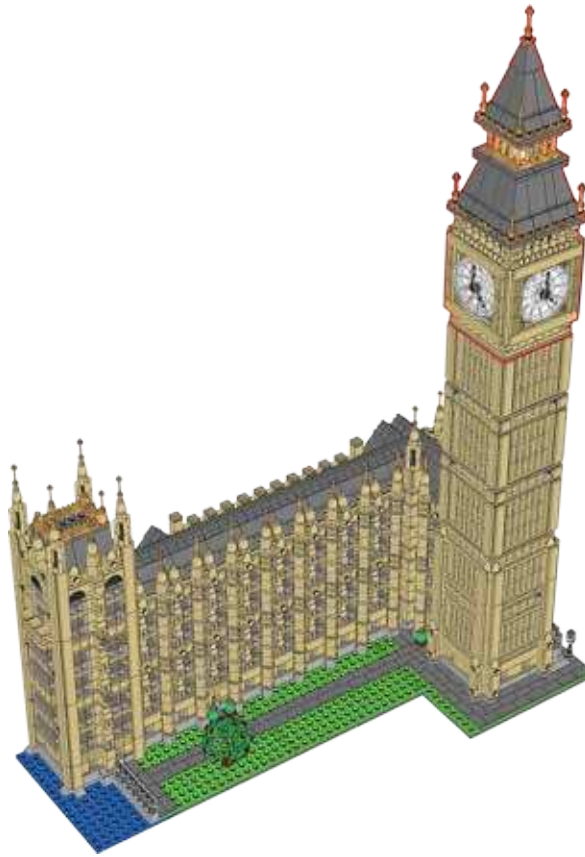

1x

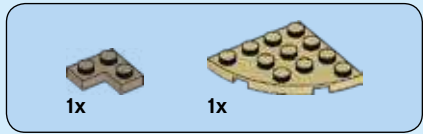

1x

1x

249

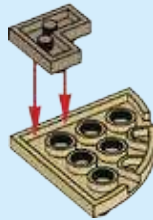

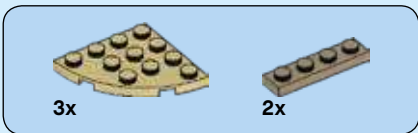

250

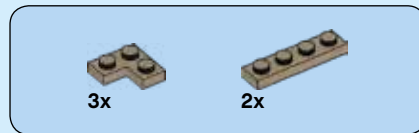
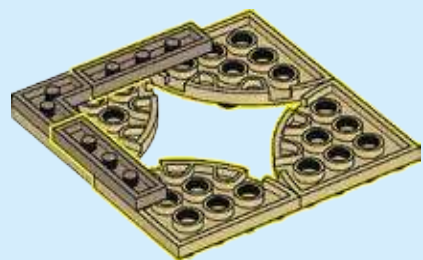

251

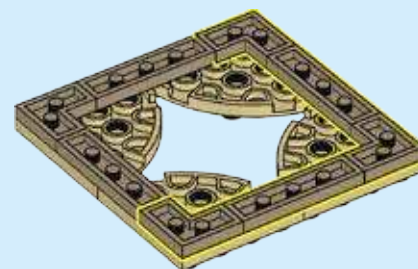

4x

8x

4x

252

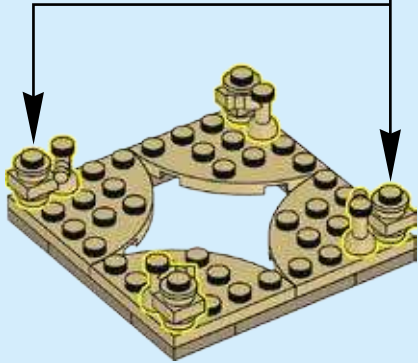
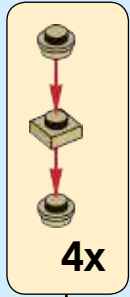
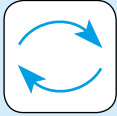

4x

20x

253

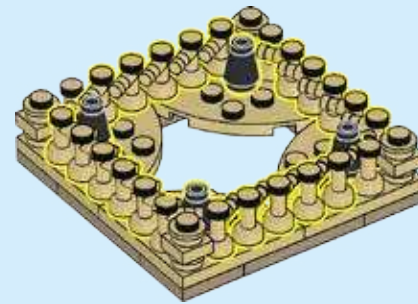

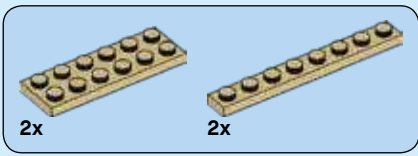

254

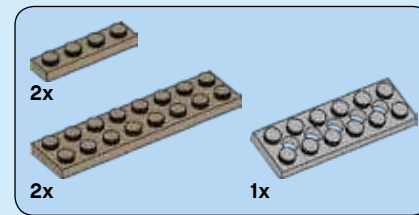
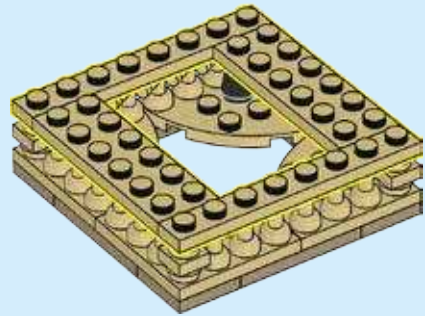

255

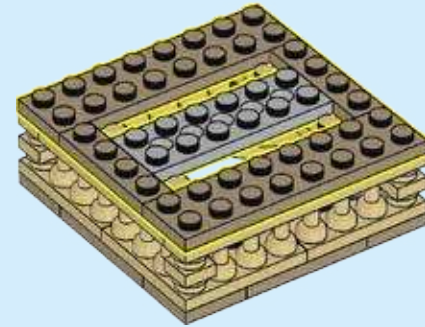

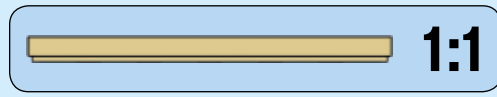
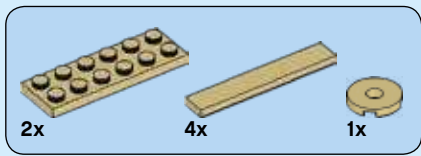

256

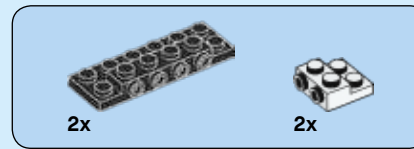
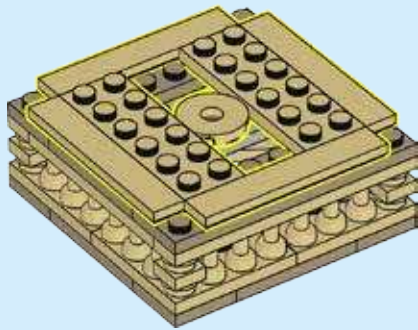

257

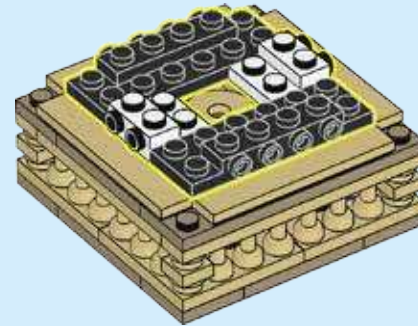

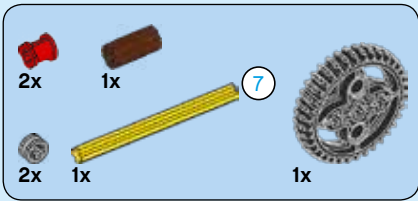

258

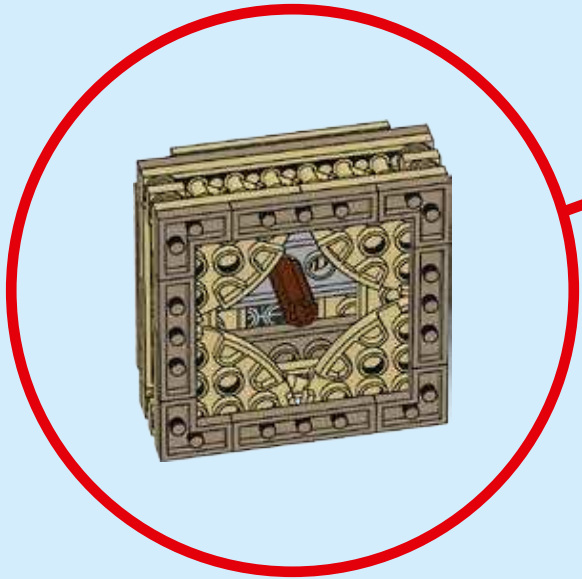
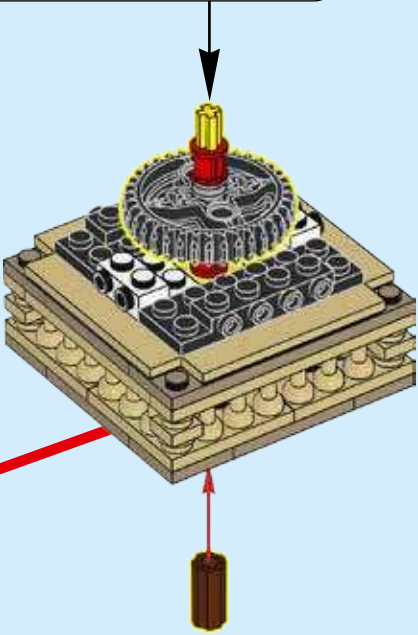
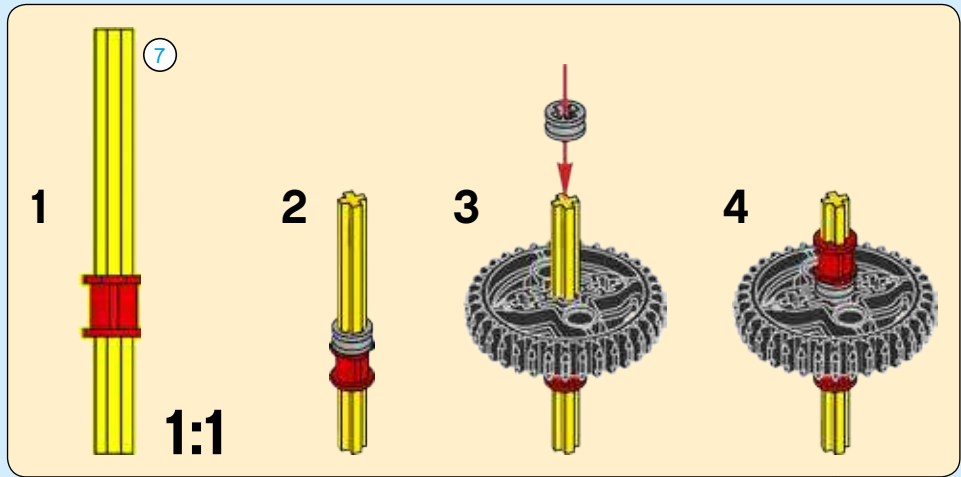



4x

259

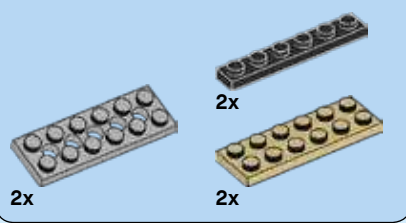
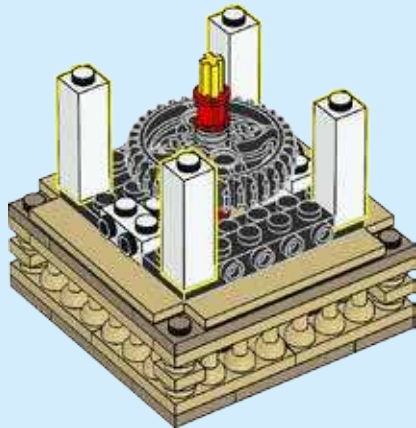

260

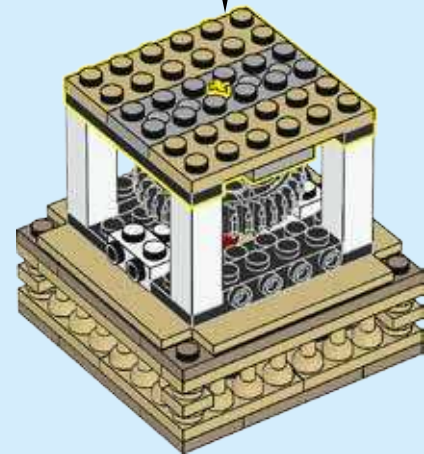
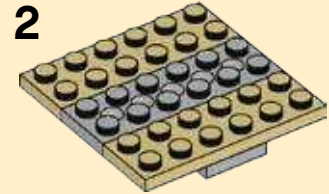
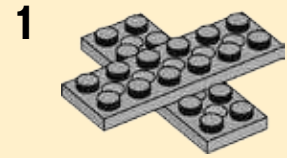



4x



4x

261

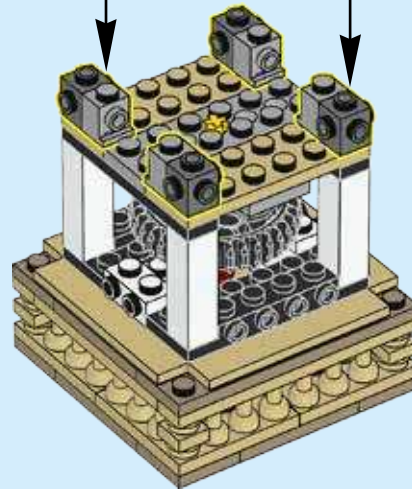
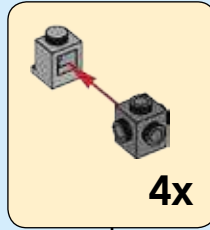

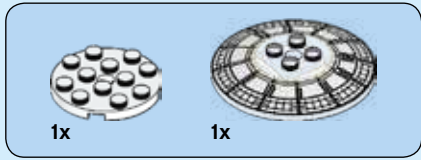
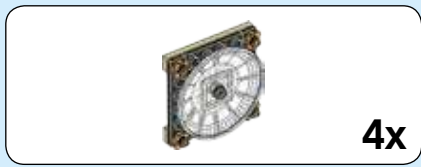

262

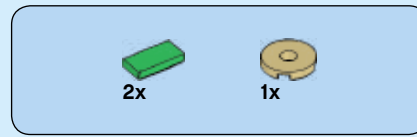
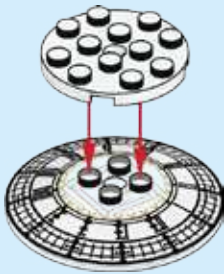

263

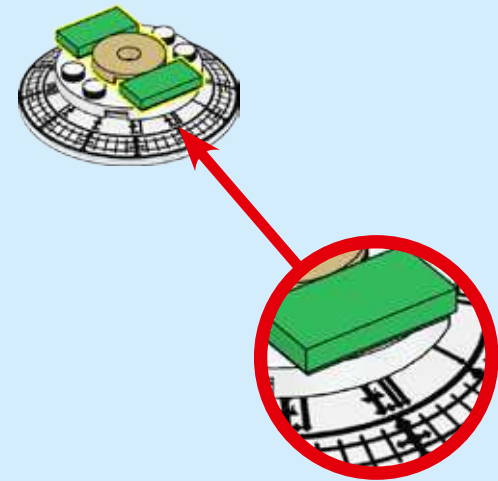



264

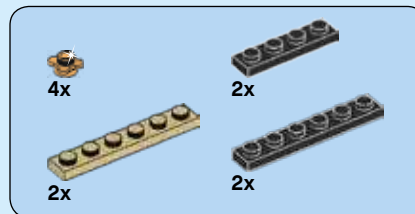
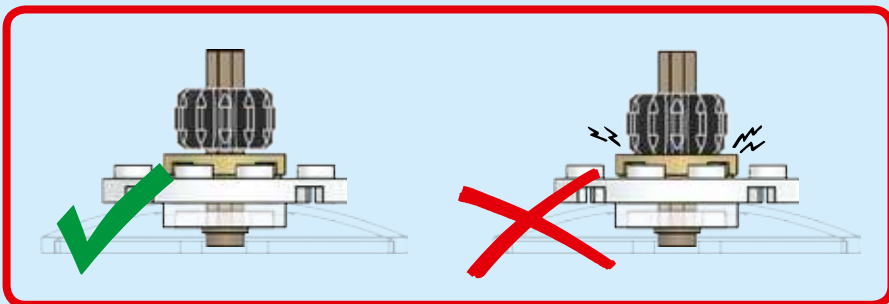
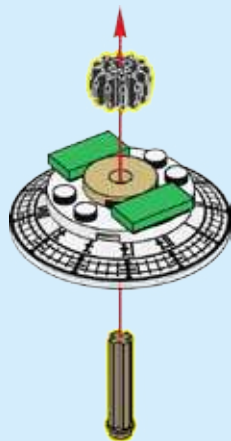

265

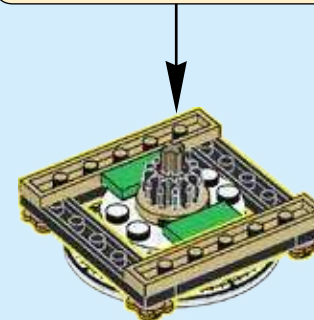
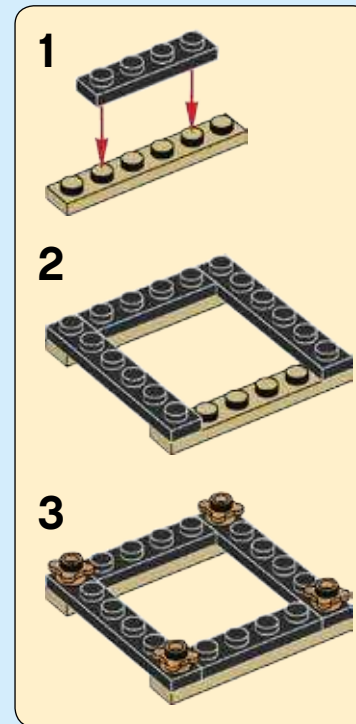

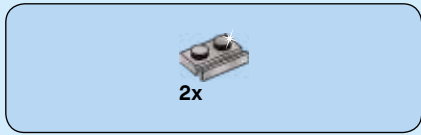

266

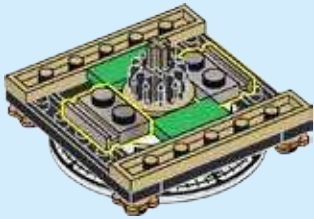

4x

267

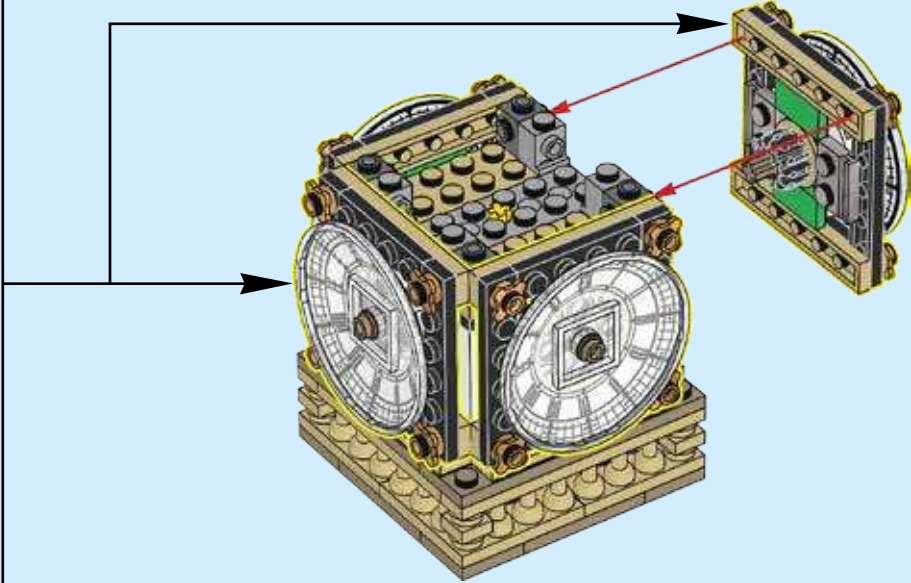

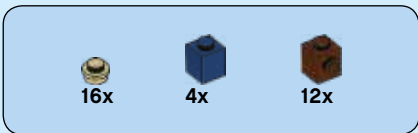

268

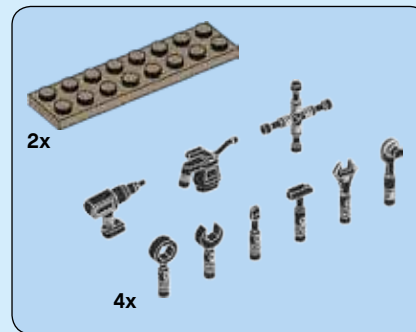
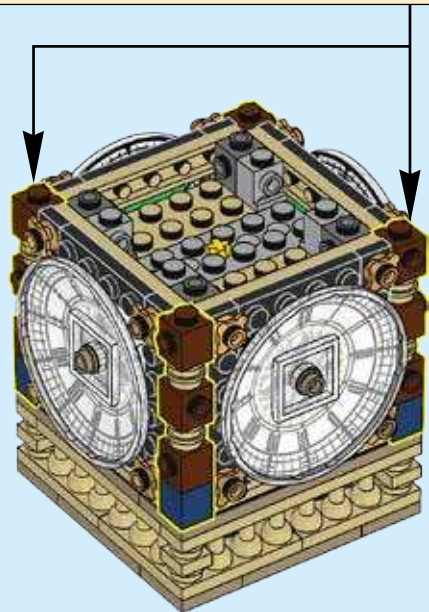
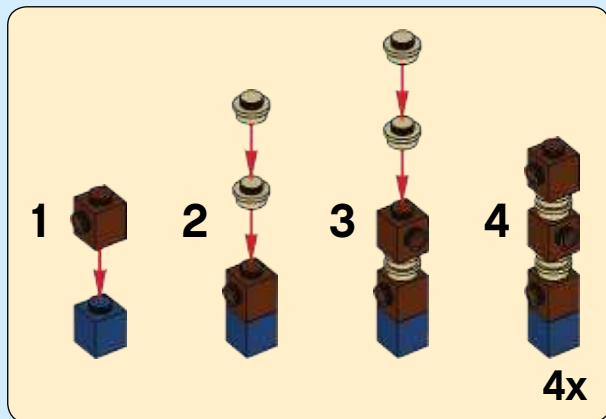

269

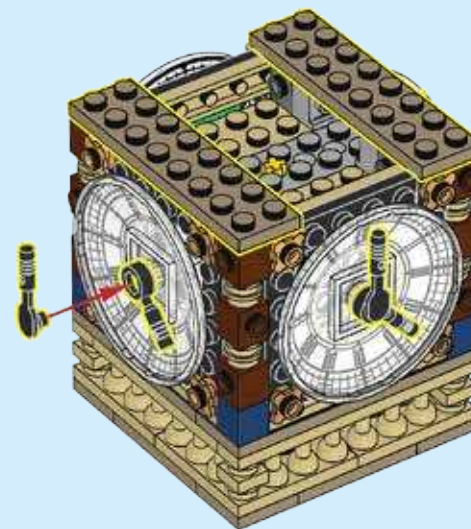

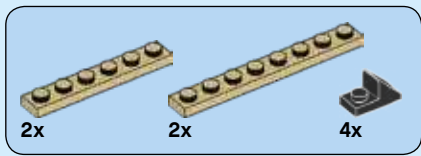

270

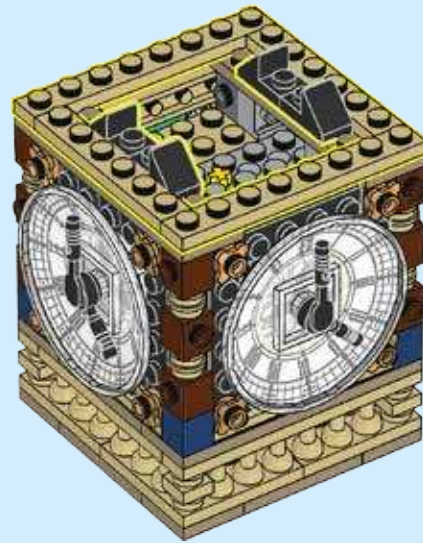

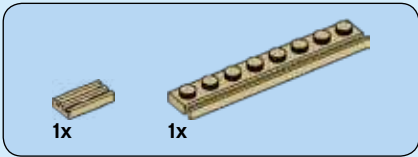
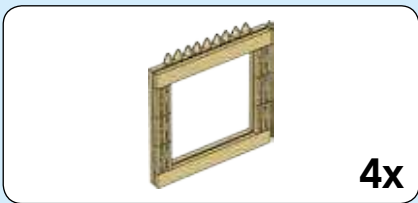

271

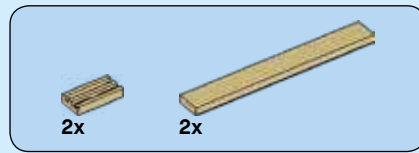
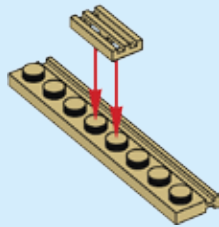

272

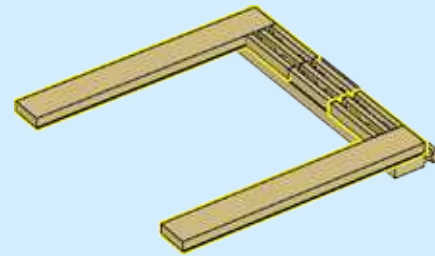

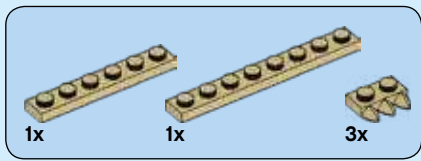

273

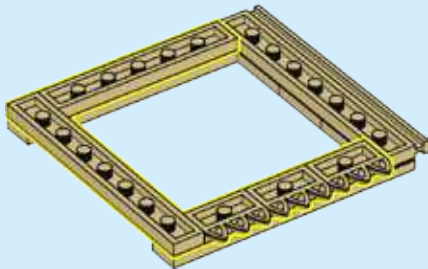
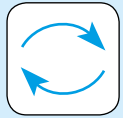

274

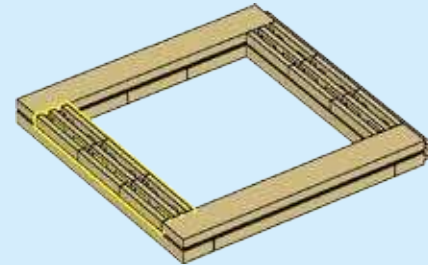
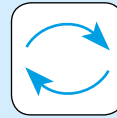

4x

275

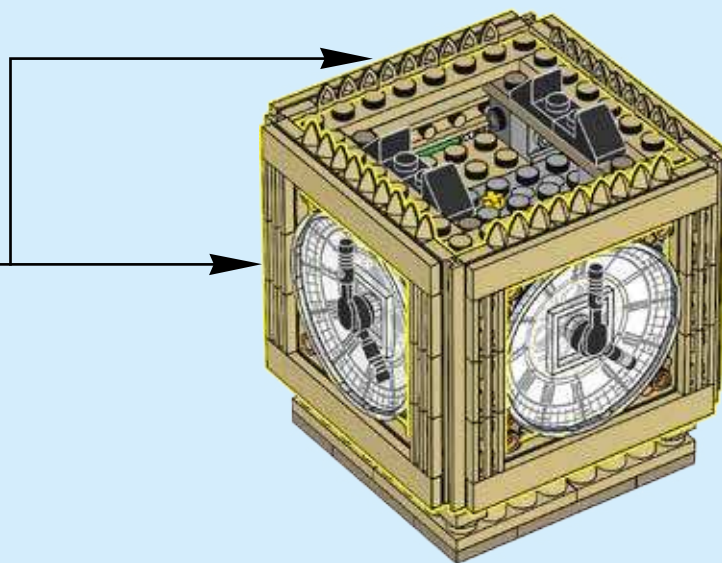

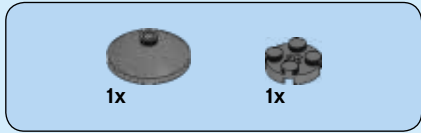

276

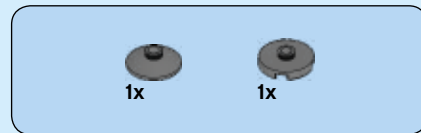
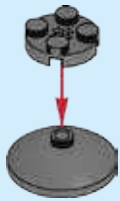

277



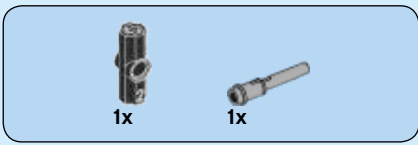

278

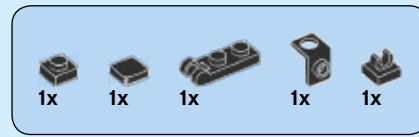
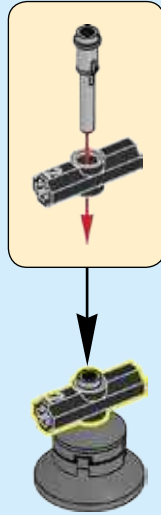

279

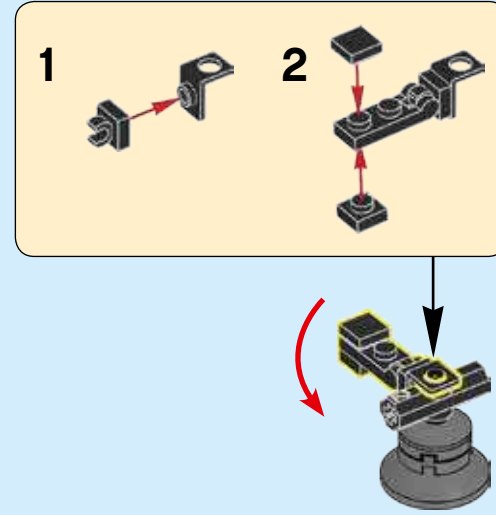

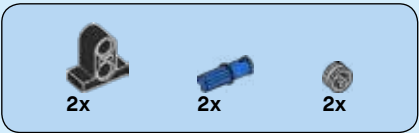

280

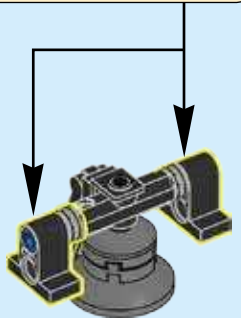
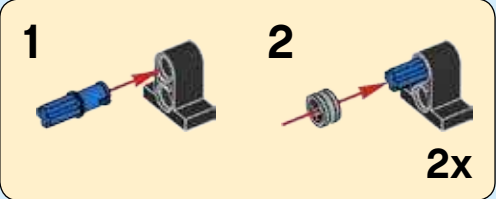

281

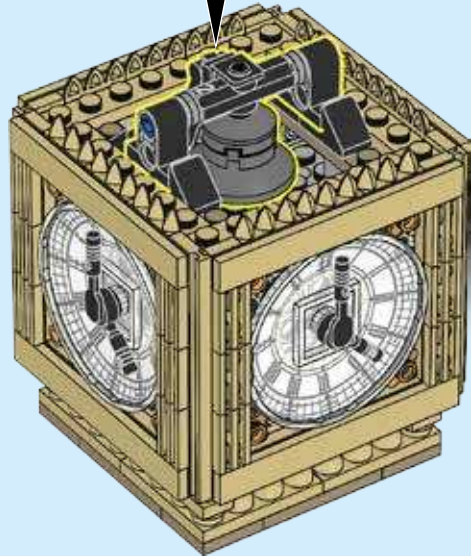

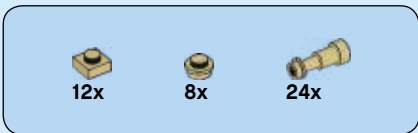

282

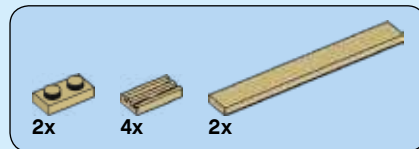
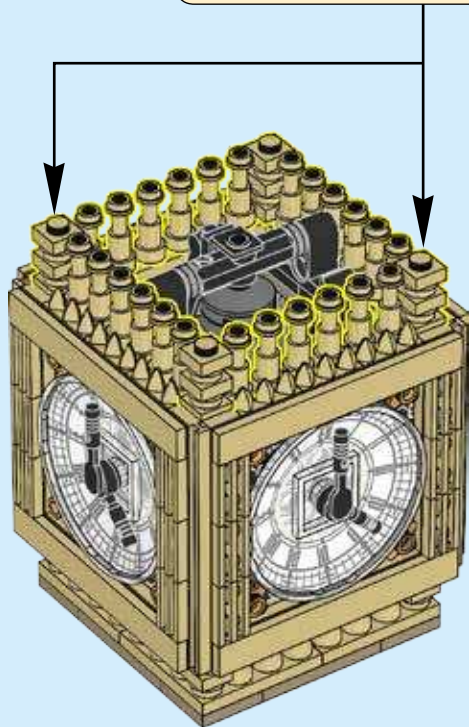
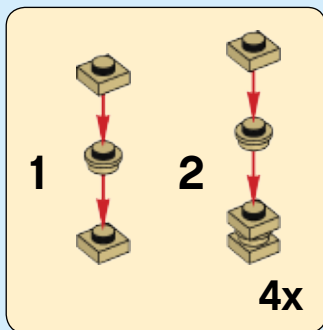

283

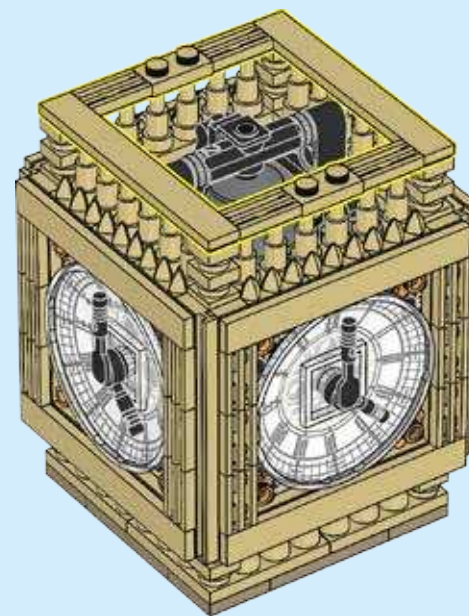

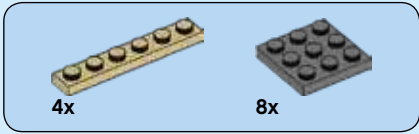
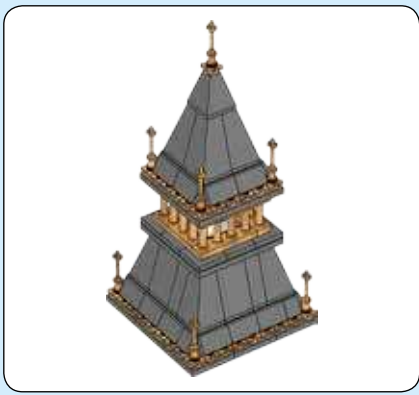

284

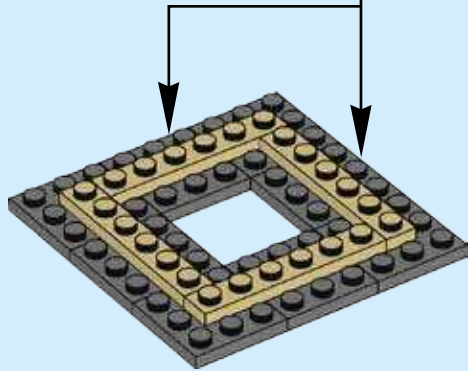
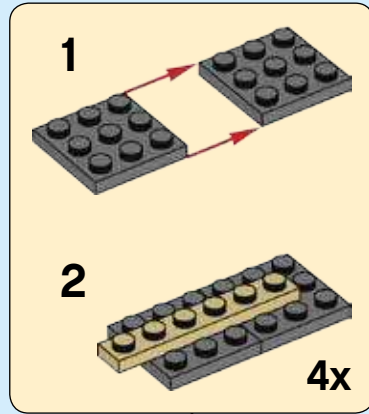

285





286

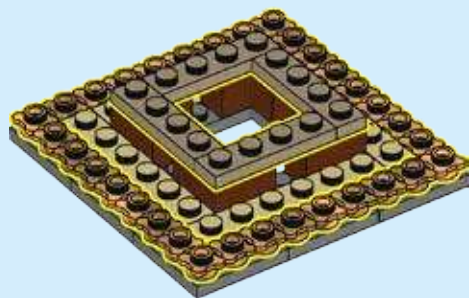

287

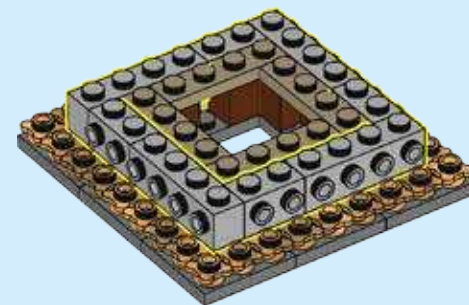

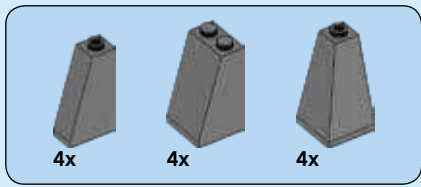

288

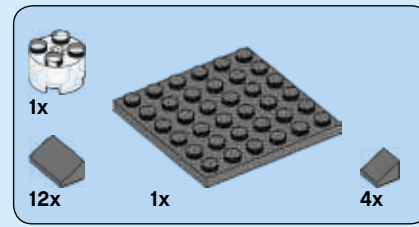
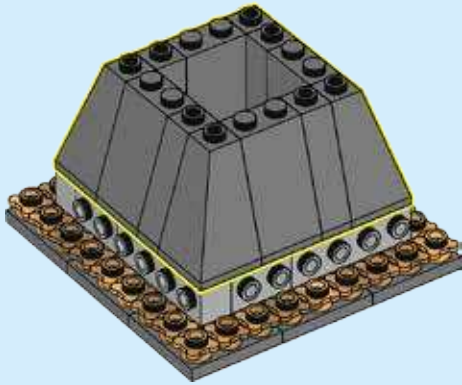

289

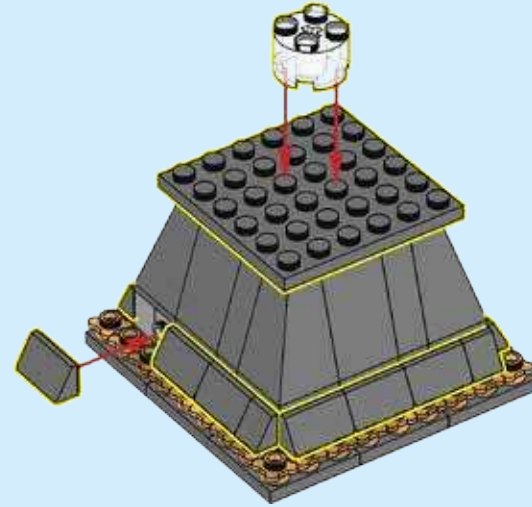

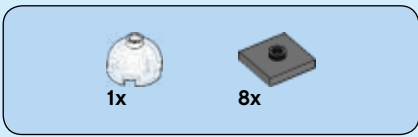

290

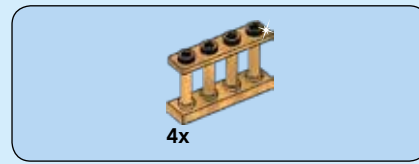
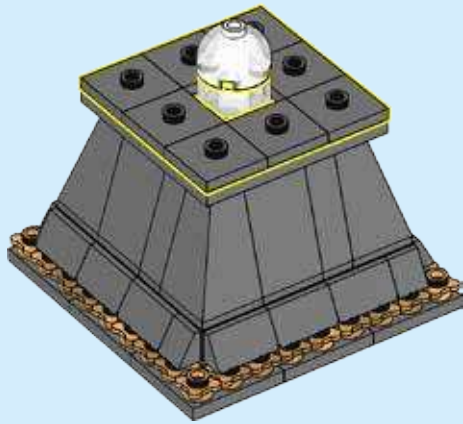

291

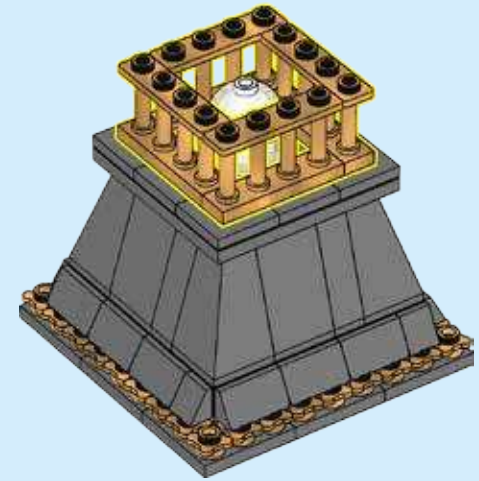



16x

292

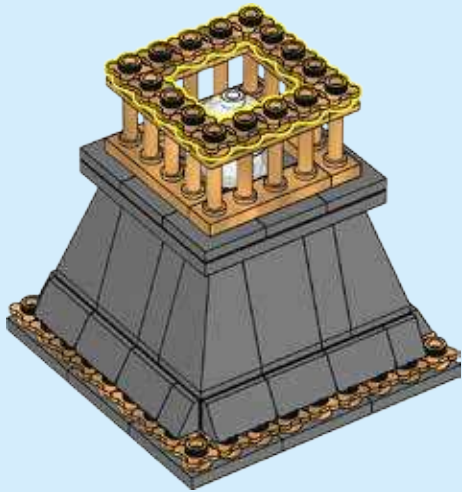

1x

293

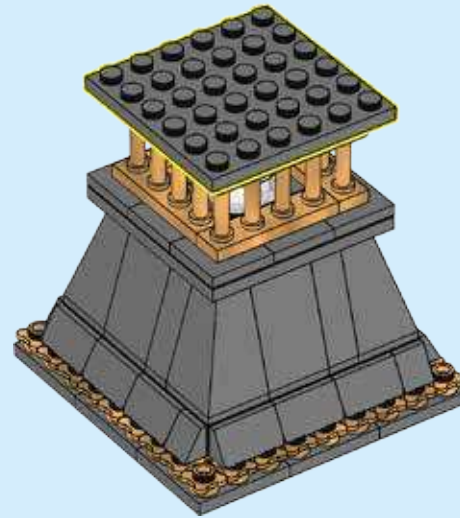

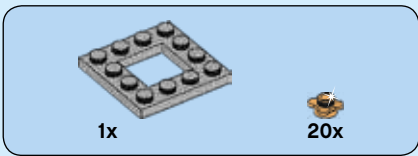

294

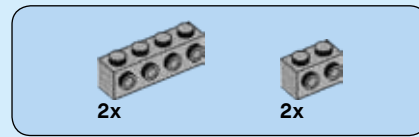
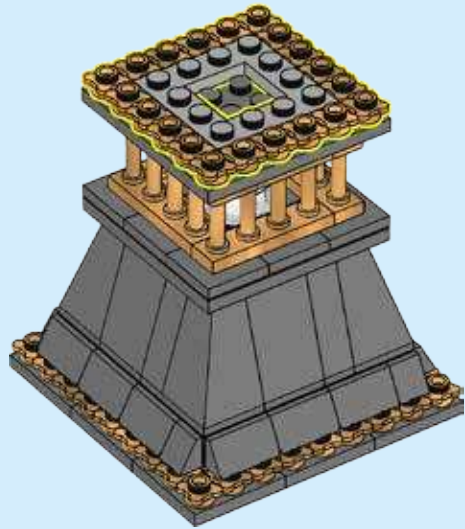

295

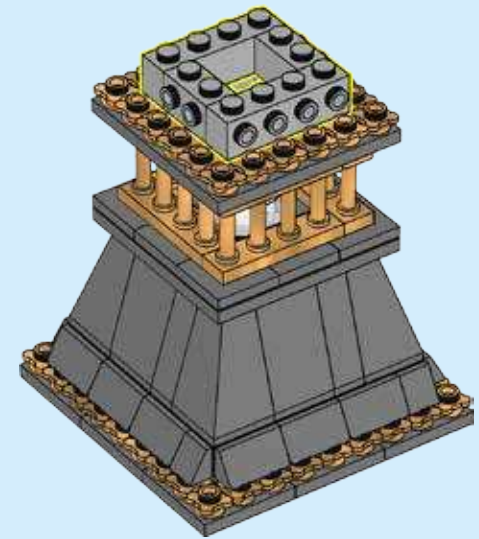

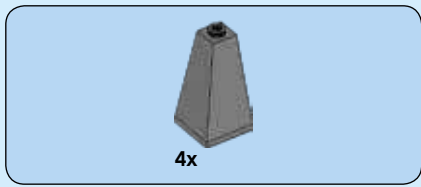

296

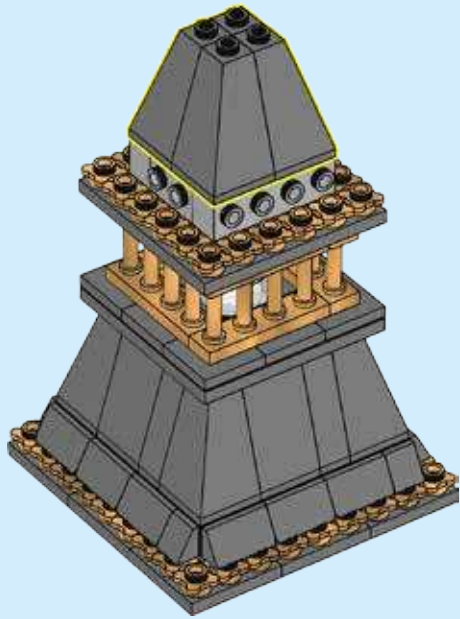

297

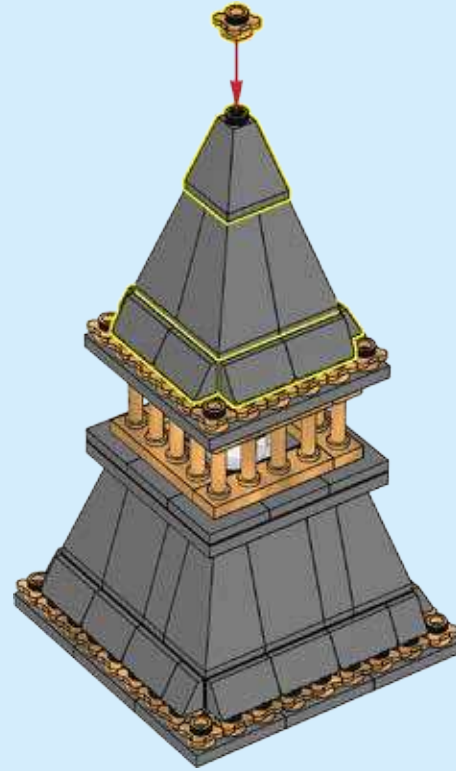

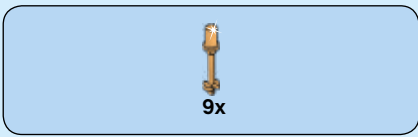

298

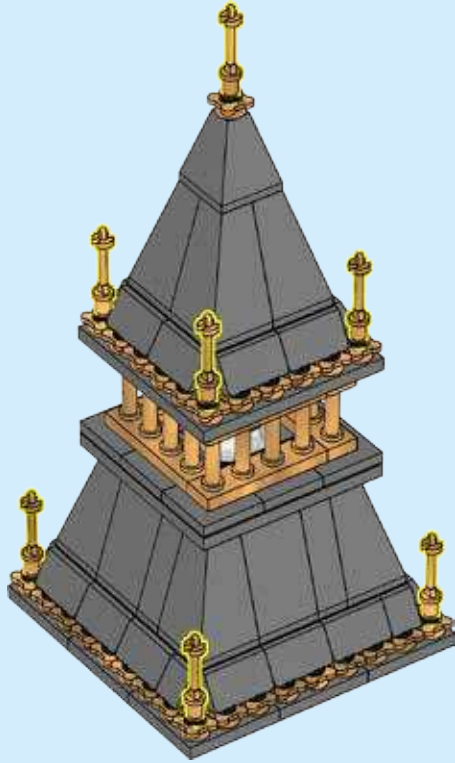

299

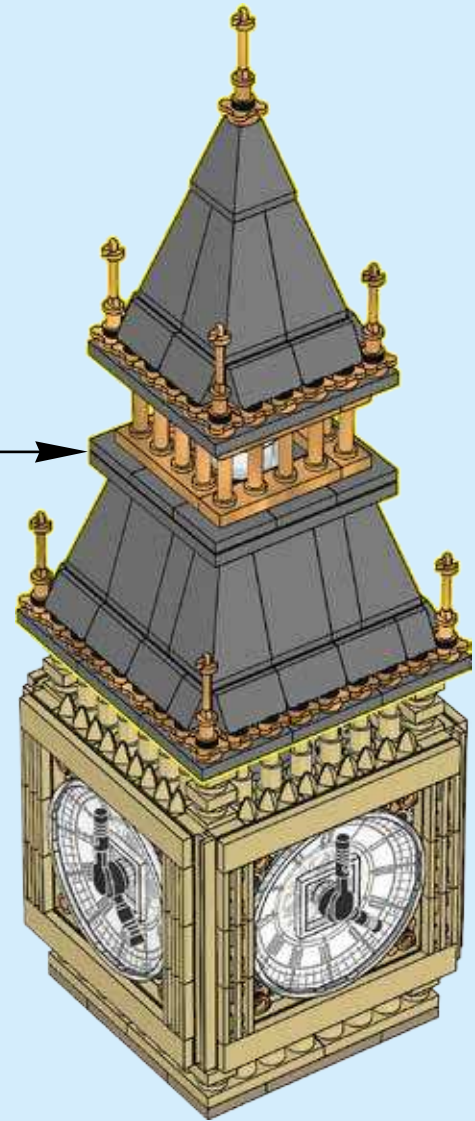

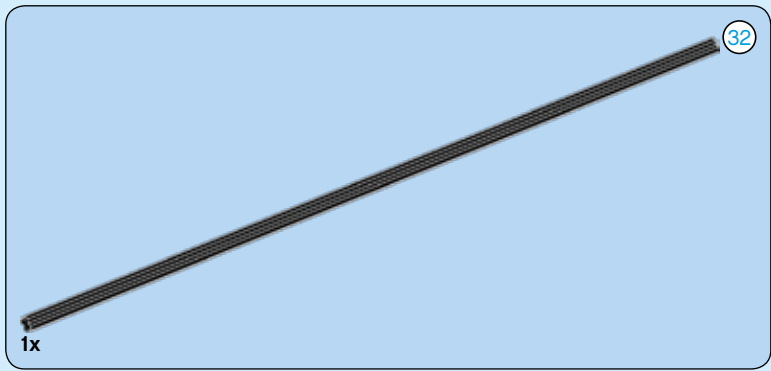

300

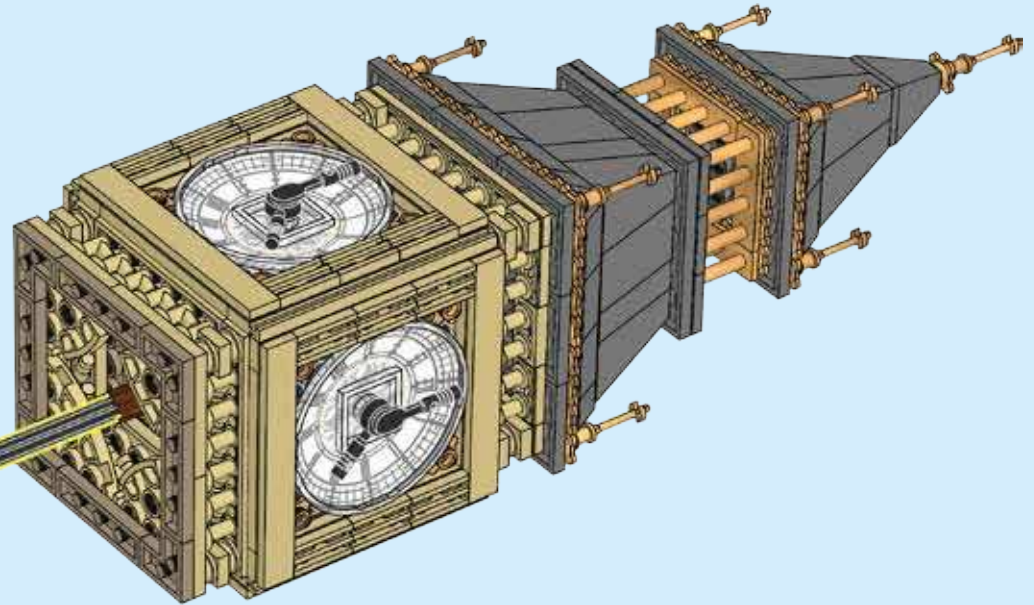
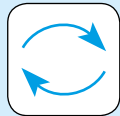

32

301

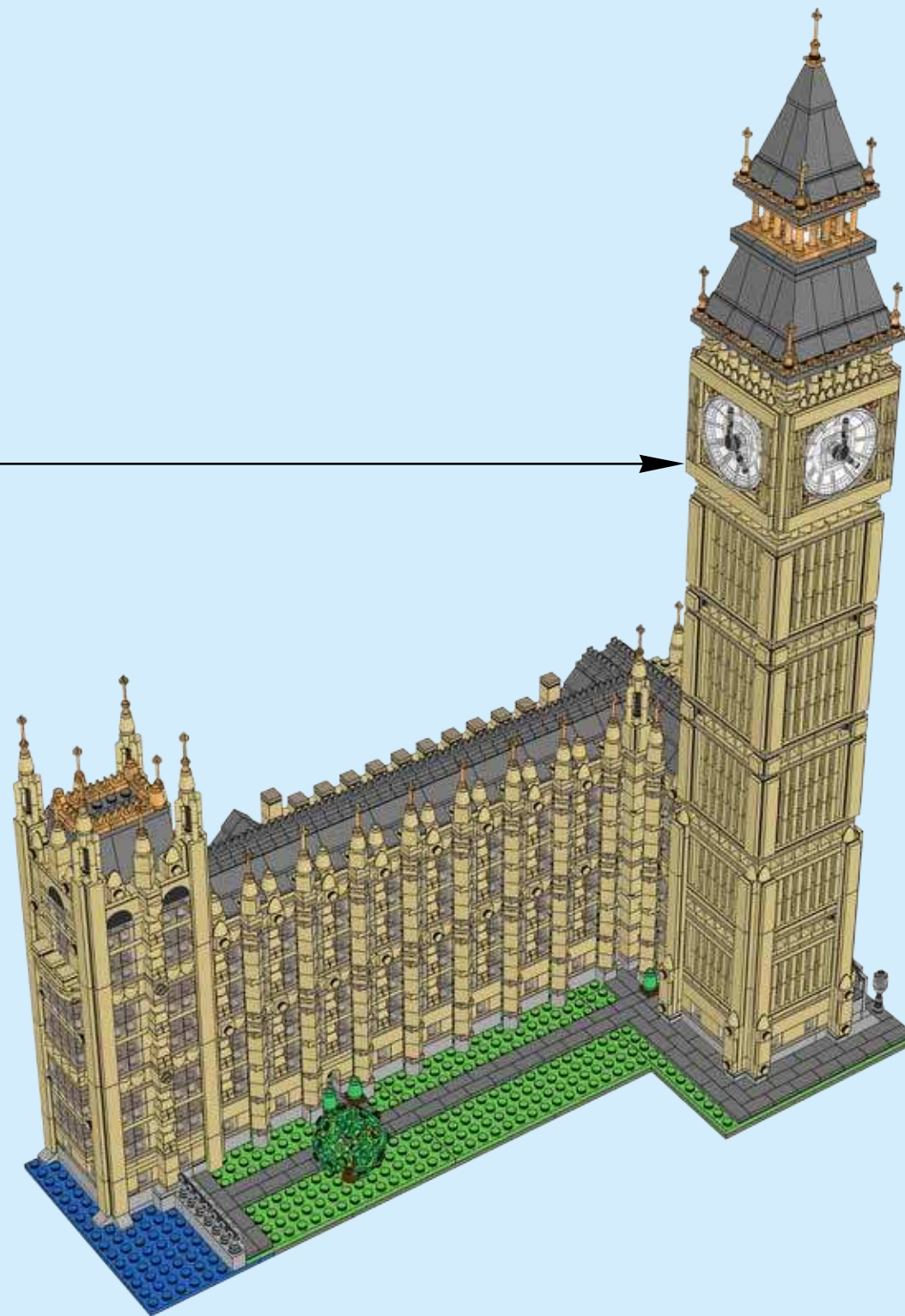

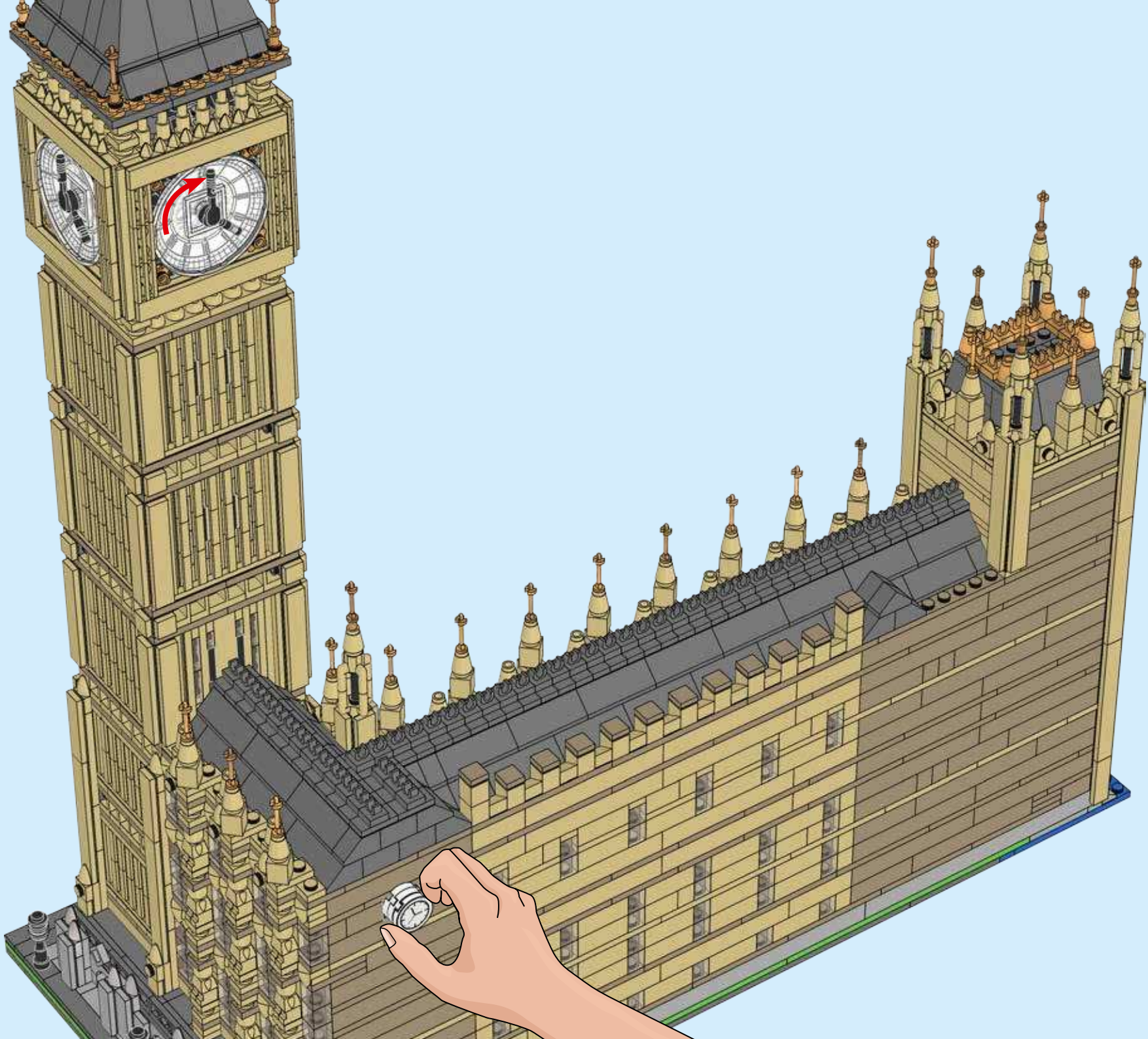

4x 6055541
 2x 403201
 1x 6052201
 12x 302301
 5x 6070327
 4x 6058329
 2x 6046979
 2x 370101
 4x 4515347
 88x 4161734
 32x 4529237
 47x 4585486
 24x 6151066
 16x 4118793
 2x 4179771
 11x 4516055
 374x 4159553

205x 4113915
 61x 4612603
 22x 4125253
 2x 4565452
 78x 6143058
 10x 6143062
 33x 4224793
 2x 6029889
 2x 4140562
 5x 6115248
 28x 4109995
 28x 4124456
 18x 6092587
 2x 4205107
 14x 6153157
 16x 4114026
 84x 4113917
 2x 4655257

24x 6060850
 12x 6046907
 276x 4160483
 13x 4114306
 15x 4114077
 6x 4124455
 18x 6061575
 2x 4618651
 6x 6131896
 32x 4121921
 41x 4162465
 21x 4550324
 30x 4113233
 7x 4113916
 3x 4550323
 4x 4543858

3x 4114309
 67x 4124067
 4x 4112982
 82x 4157277
 6x 4618876
 4x 4570516
 9x 4113993
 38x 4544139
 34x 4114324
 13x 4159774
 4x 4161443
 1x 4113988
 1x 6130009

7

36x 407023
 2x 4206482
 2x 6127744
 2x 302323

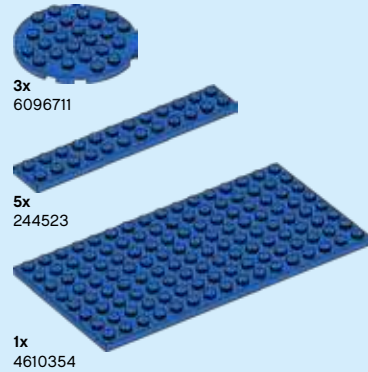

3x 6096711
 5x 244523
 1x 4610354

3x 4529239
 15x 6138691
 8x 306928
 5x 6097232
 15x 4619599

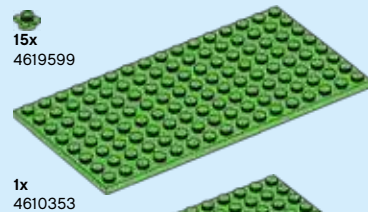

1x 4610353

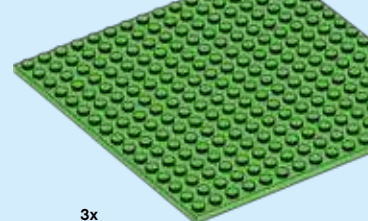

3x 4611777

3x 4538456
 7x 6038453
 16x 4529236
 3x 614126
 1x 4107783
 1x 6066102
 1x 307026
 1x 302426
 1x 6020192
 4x 4177431
 4x 6069000
 2x 4144024
 1x 370026
 18x 6016172

18x 6020193
 6x 6093525
 3x 4200023
 1x 6089119
 1x 4515368
 1x 6116604
 8x 371026
 1x 4255563
 10x 366626
 2x 4653049
 4x 6030875

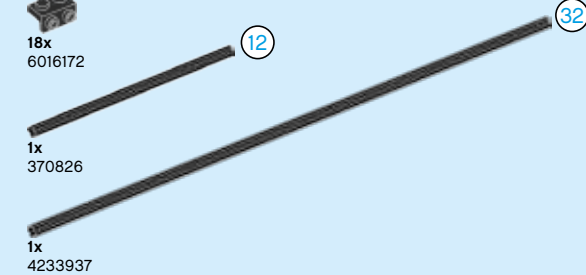

12

32

- 6x 3005740
- 1x 6093059
- 1x 4143346
- 4x 4167842
- 6x 4620810
- 4x 6153247
- 77x 6030982
- 380x 6102359
- 102x 6001197
- 22x 4255413
- 3x 4528488
- 12x 4528981
- 4x 4264569

Customer Service
Kundenservice
Service Consommateurs
Servicio Al Consumidor
LEGO.com/service or dial
00800 5346 5555 : 
1-800-422-5346 : 

- 17x 6055172
- 79x 4549436
- 4x 6001824
- 1x 6005897
- 17x 4528604
- 4x 4521914
- 4x 6092591
- 18x 6151557
- 23x 4550168
- 6x 6031821
- 20x 6132768
- 51x 4626904
- 9x 6001822
- 4x 4267874

- 1x 6055631
- 78x 6015424
- 10x 4247151
- 28x 6151537
- 26x 6024124
- 4x 4246957
- 4x 4251796
- 4x 4216581
- 2x 6062600
- 82x 6062574
- 13x 4221744
- 2x 4531751
- 8x 4211200
- 2x 4211201
- 2x 4216615

5

- 4x 4211573
- 5x 4211476
- 5x 4521921
- 9x 4211389
- 6x 4211399
- 5x 4211415
- 15x 6066097
- 2x 4211388
- 4x 4211398
- 2x 4211414
- 6x 6015344
- 2x 4233493
- 2x 4211353
- 3x 4211413
- 7x 4211349
- 3x 4654577
- 1x 4520320
- 4x 4211366

- 1x 4645397
- 10x 4211428
- 10x 4558169
- 6x 4211636
- 2x 4211394
- 4x 4211435
- 2x 4211445
- 6x 4211393
- 4x 4211549
- 9x 4612621
- 3x 4211542
- 1x 4211425
- 2x 4211407
- 4x 4211366

- 2x 6012451
- 24x 4211098
- 12x 4210719
- 21x 4504378
- 52x 6071226
- 7x 4210848
- 53x 4210700
- 2x 4226221
- 20x 4567887
- 1x 4211042
- 1x 4211010
- 1x 6115080
- 70x 4211052
- 4x 4211088
- 65x 6092572
- 4x 4221745
- 11x 4211135
- 8x 6126083

- 8x 6035351
- 10x 6000853
- 1x 4645099
- 7x 4211054
- 5x 4210702
- 1x 4210865
- 8x 4568734
- 5x 4211105
- 3x 4211103
- 5x 4219725
- 29x 4211127
- 8x 6039176
- 2x 4211085
- 1x 4210875

- 9x 4211002
- 3x 4211008
- 3x 4211099
- 1x 4210997
- 2x 4211134
- 6x 4210796
- 30x 6146340
- 4x 4529247
- 3x 6126113
- 85x 6143059
- 12x 6071259
- 4x 6060803
- 7x 4625146
- 8x 6132264
- 1x 4654448

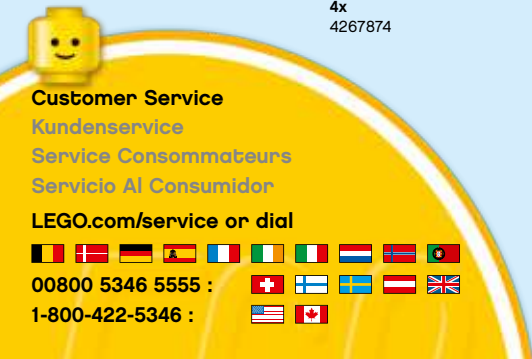



10214

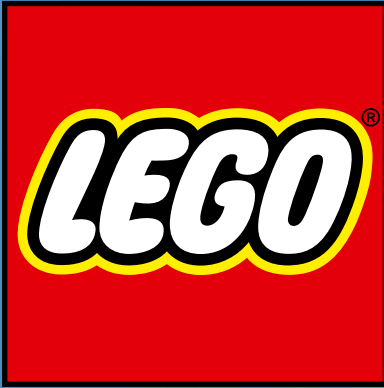

club™

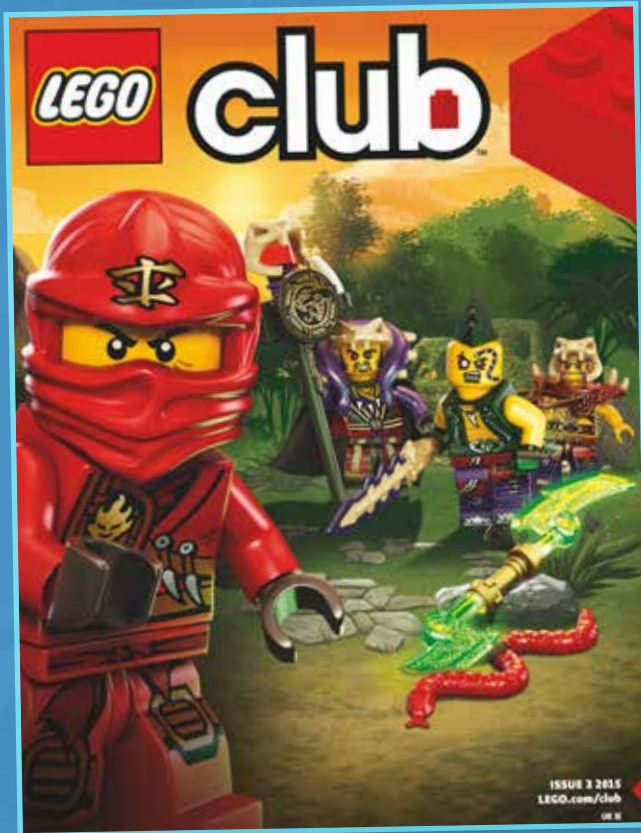

1

2

3





CREATOR



Showcase your awesome builds
with the new Creator app!

Apple and the Apple logo are trademarks of Apple Inc., registered in the U.S. and other countries.
App Store is a service mark of Apple Inc.
Google Play is a trademark of Google Inc.

[LEGO.com/creator](https://www.lego.com/creator)

