

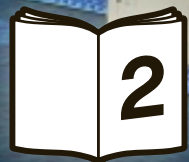

10214





52

1



2

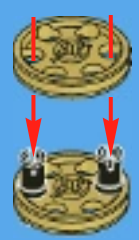

3

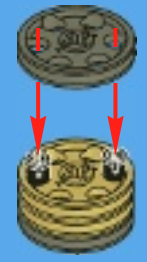

4



5



4x

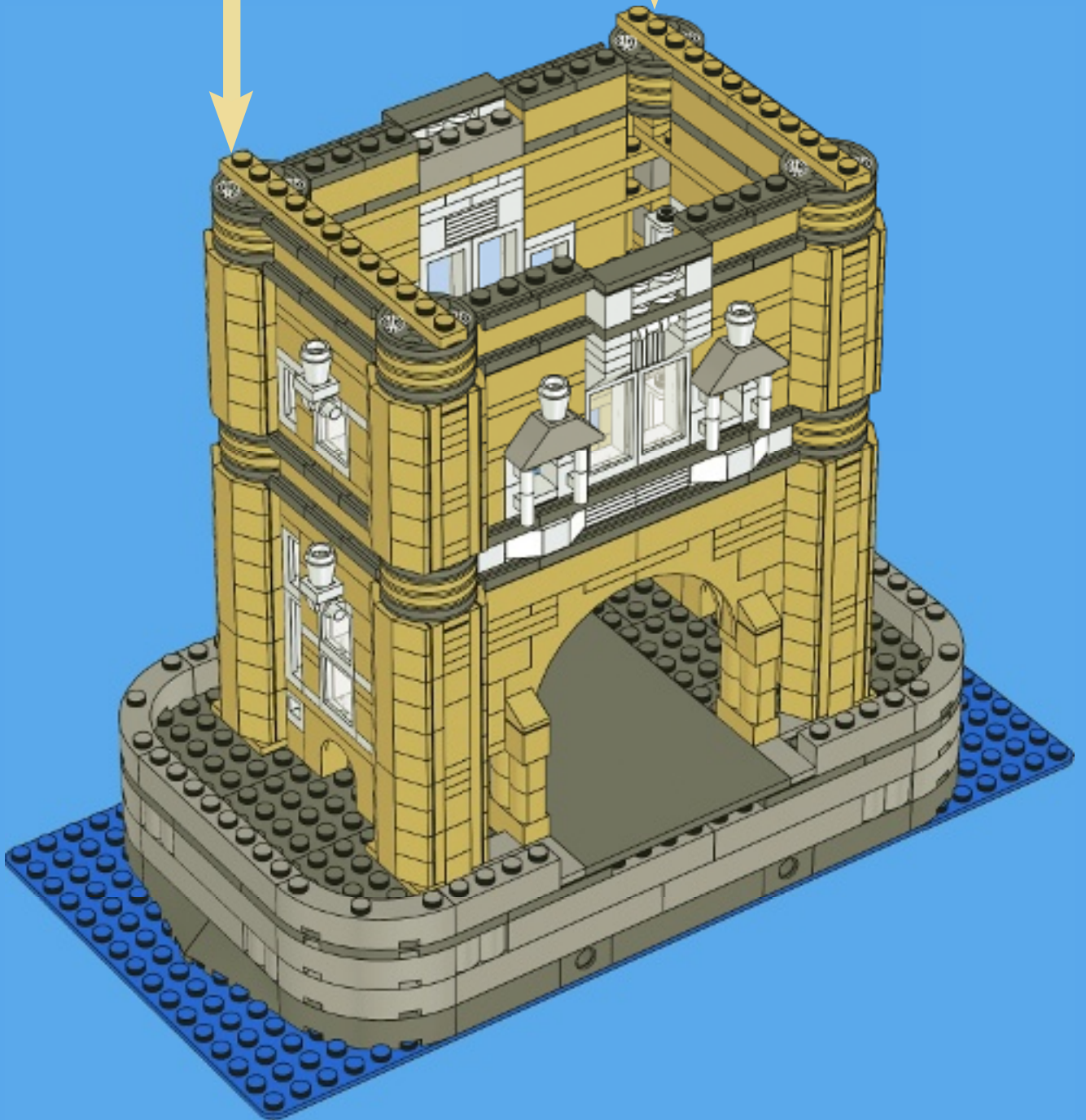



4x



10x



10x

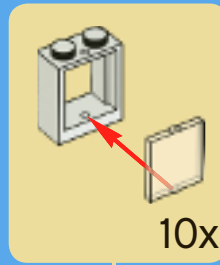

10x

53

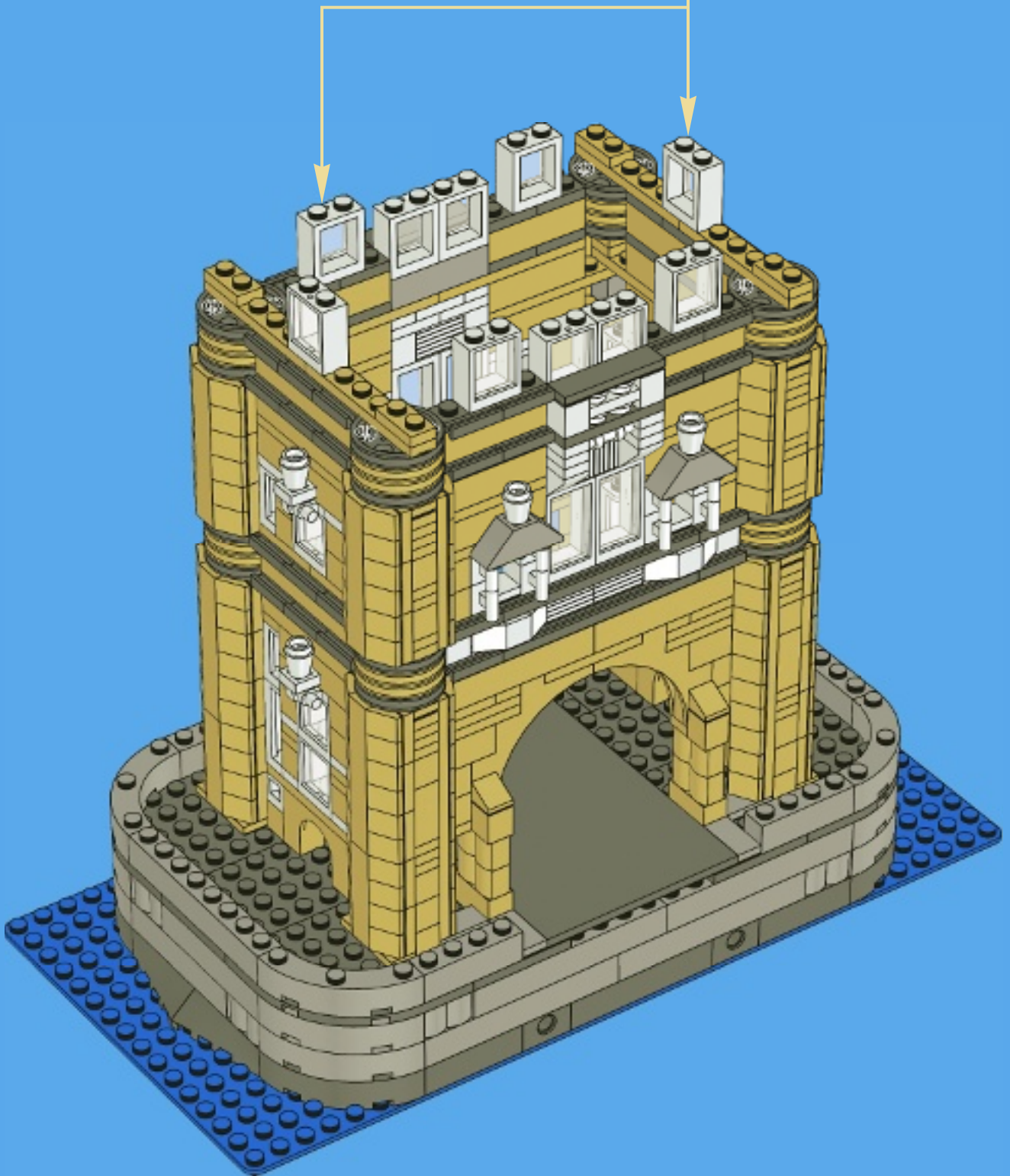



24x



4x



4x

54



12x

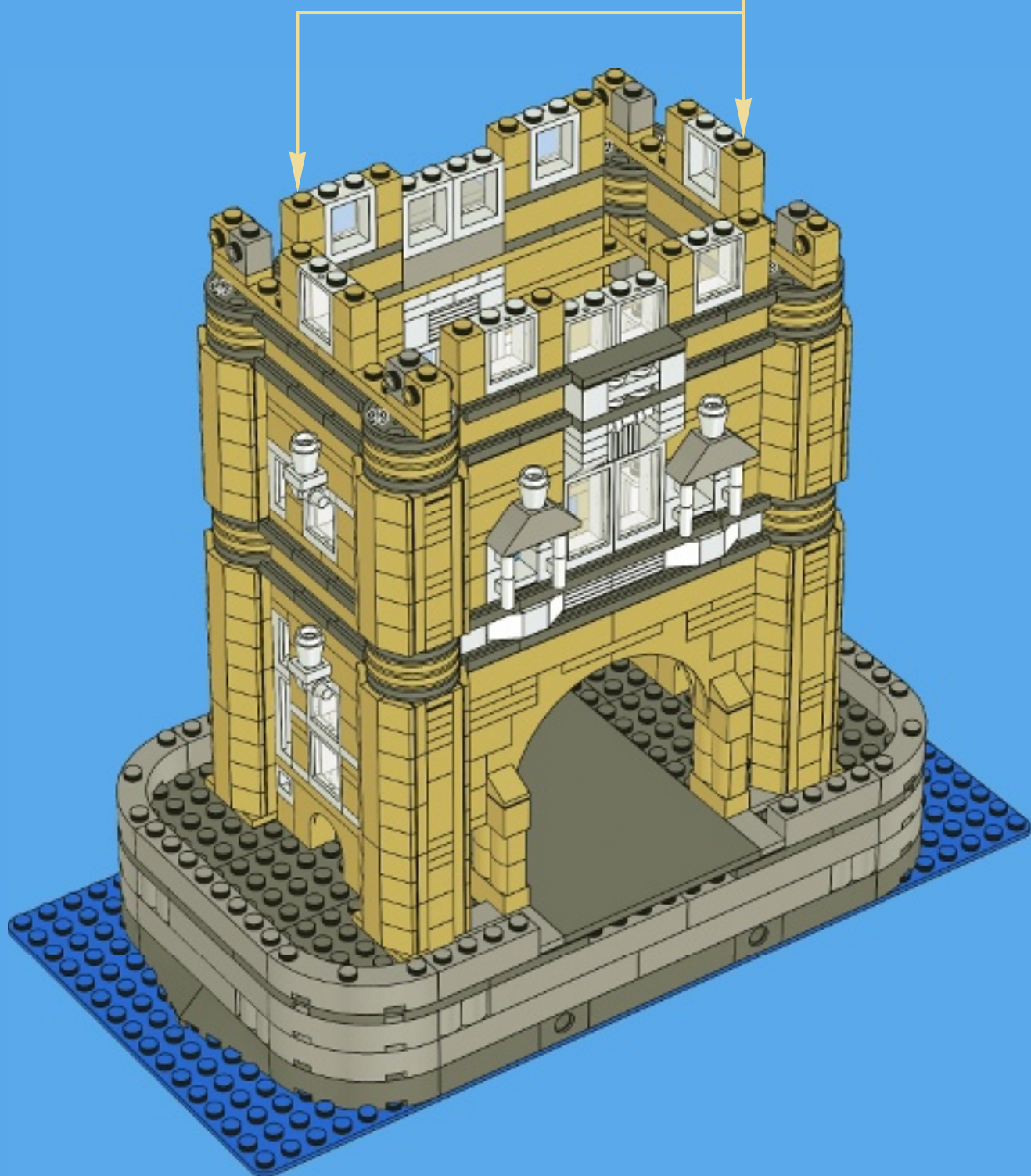



4x



4x

55

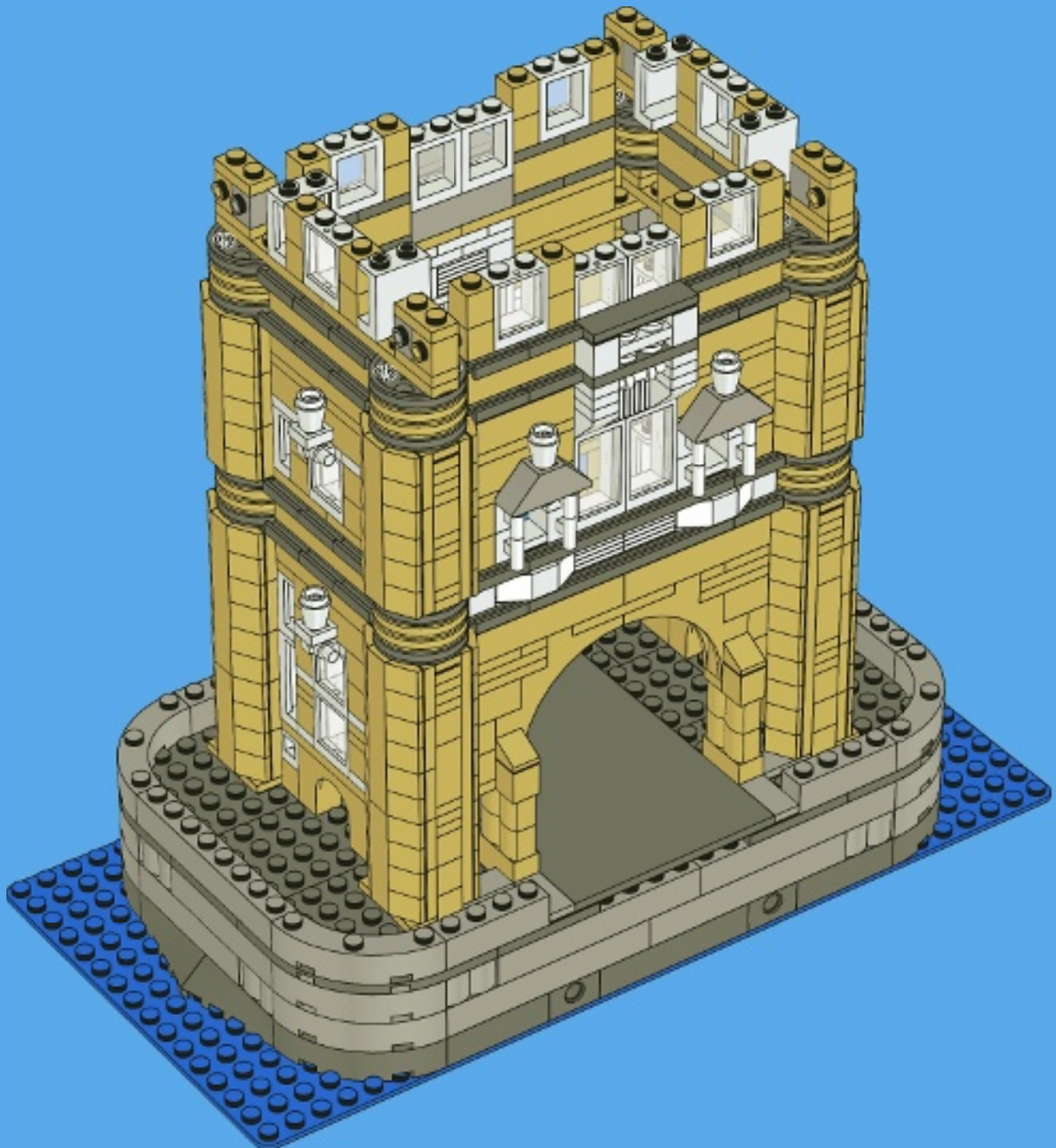

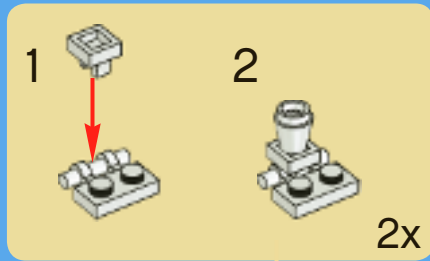

56



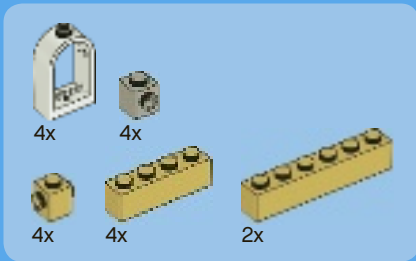

57

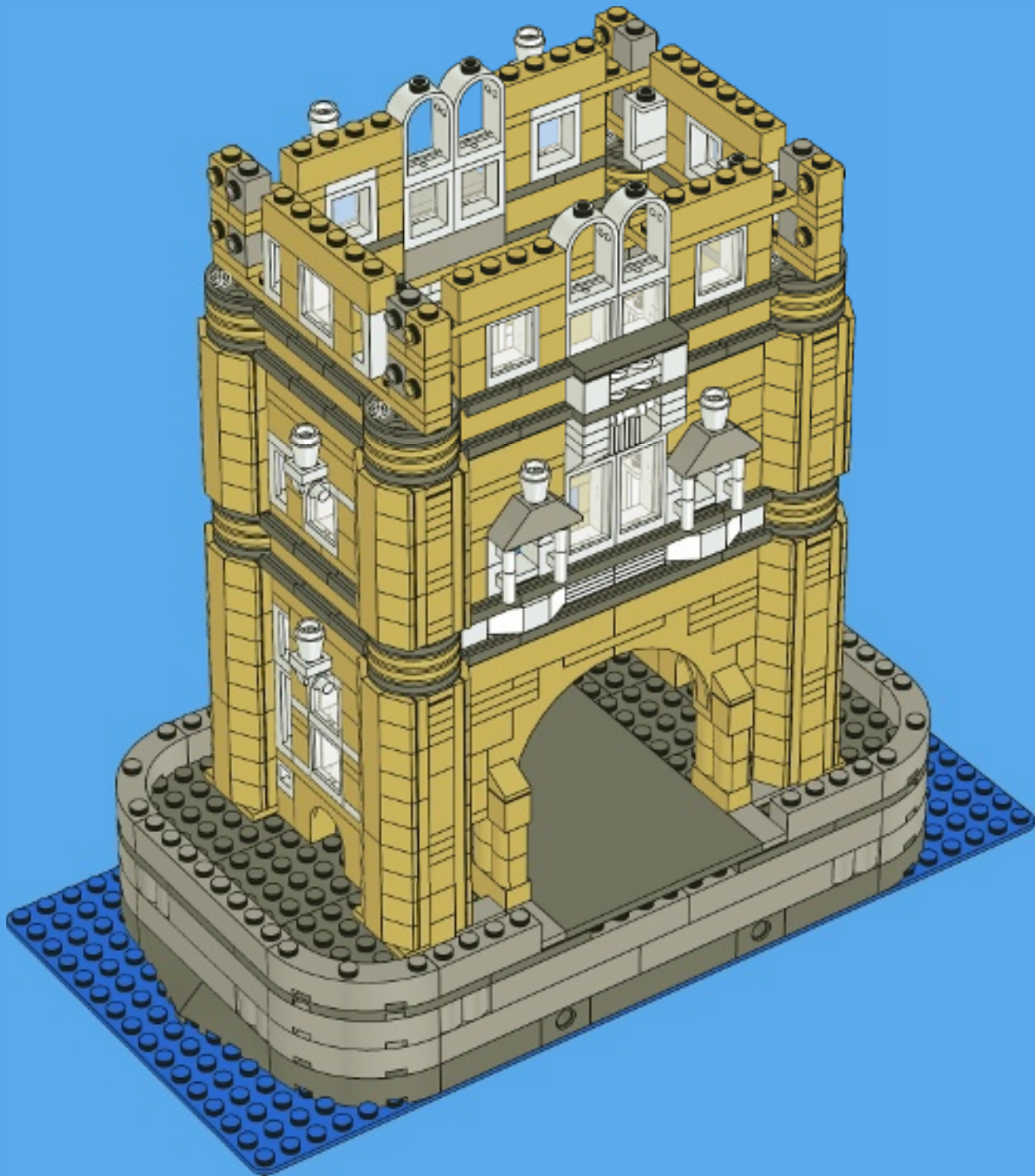



4x



4x

58

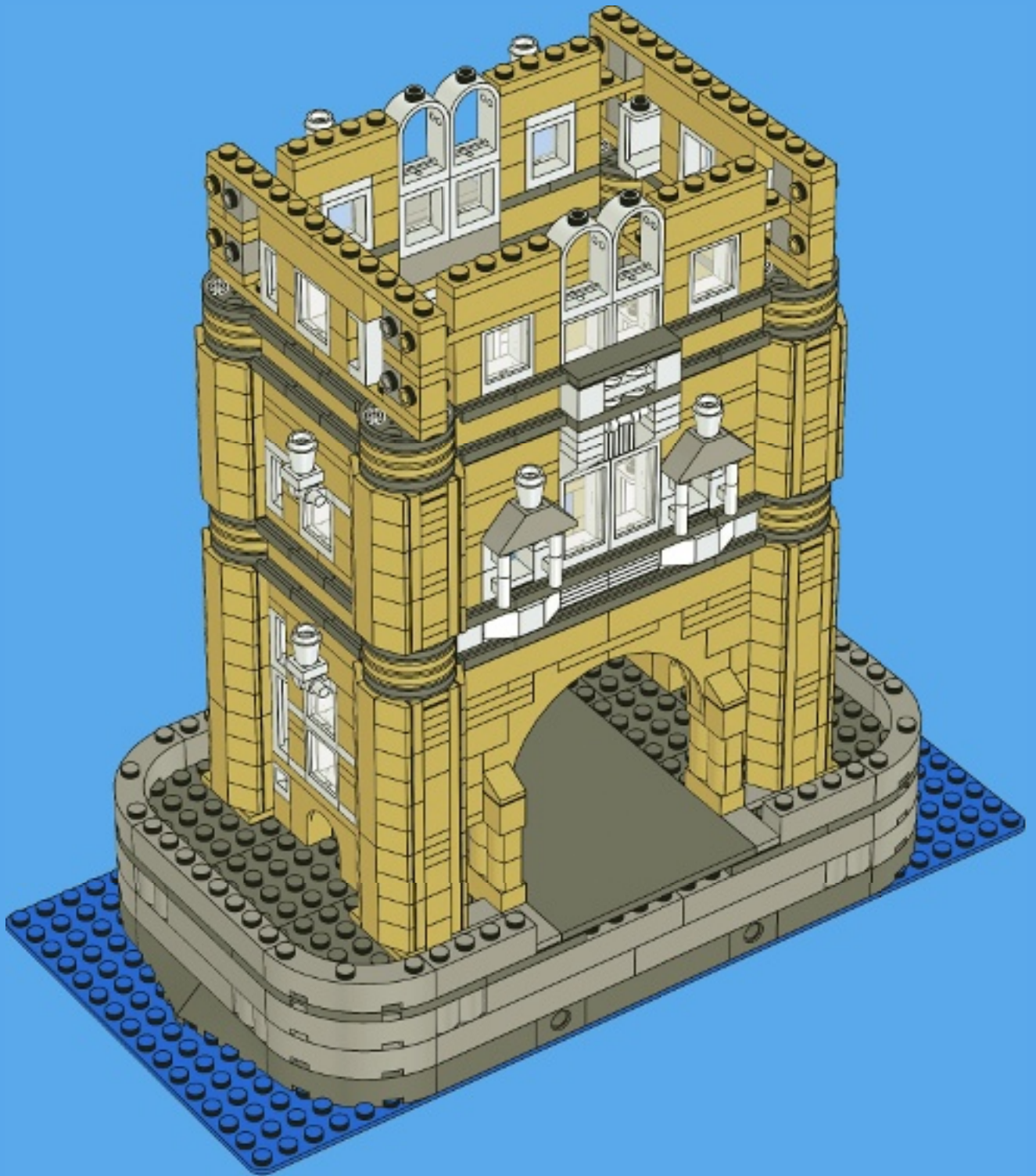



12x



4x



4x



2x

59





4x



18x



4x



4x



4x



1

2



4x

60

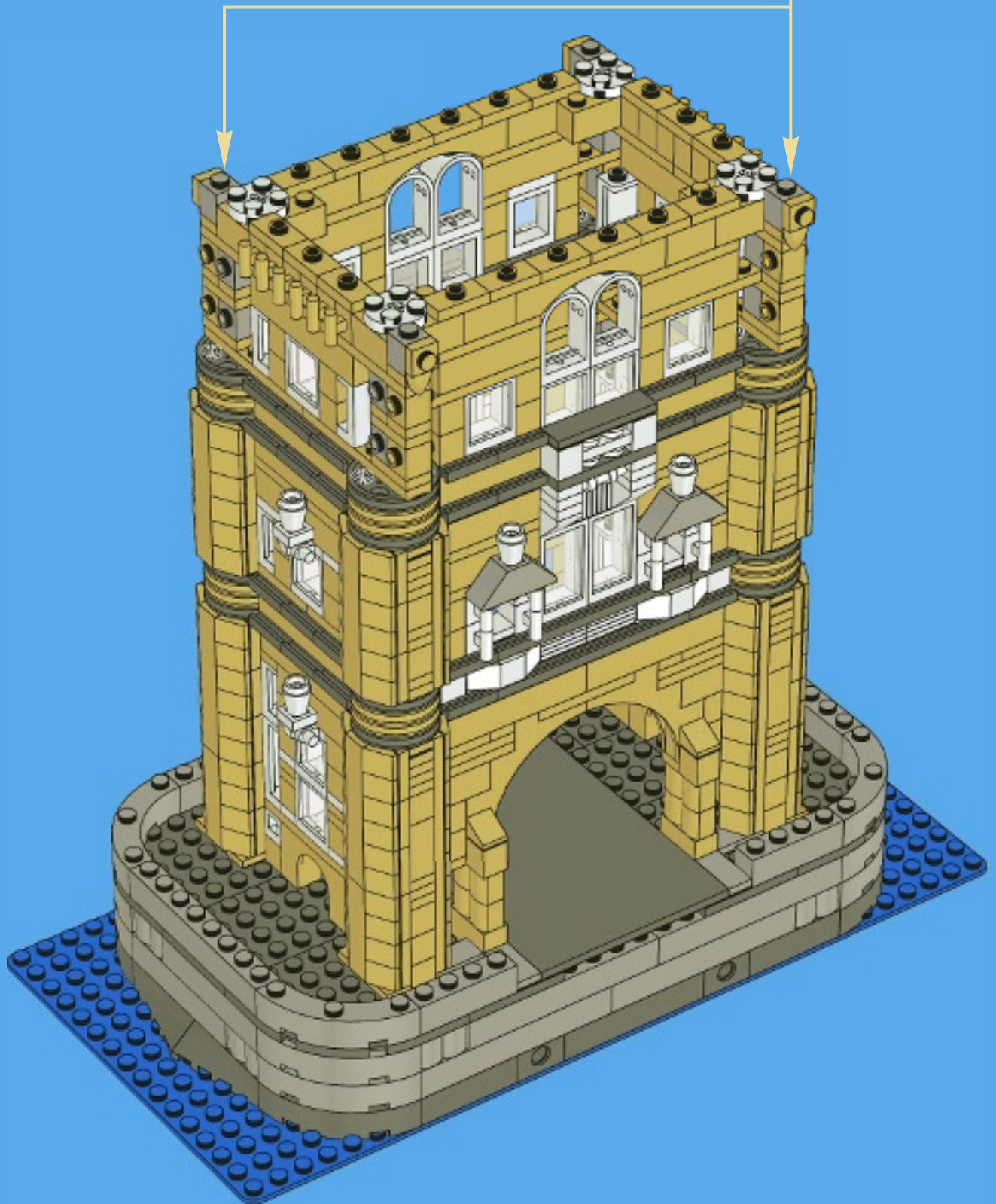



4x



24x

61

1



2

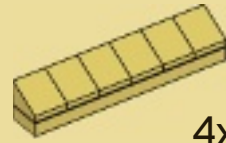

4x



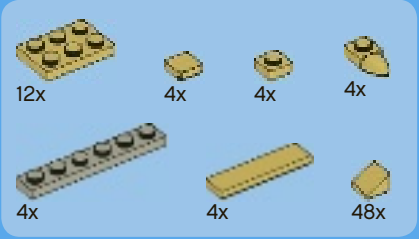

62

1

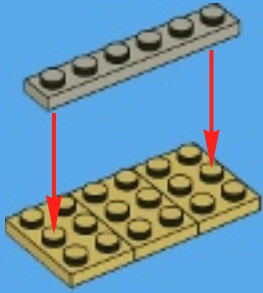

2

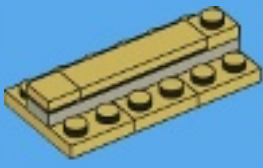

3

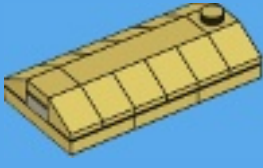

4

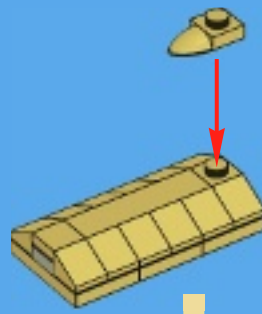

4x

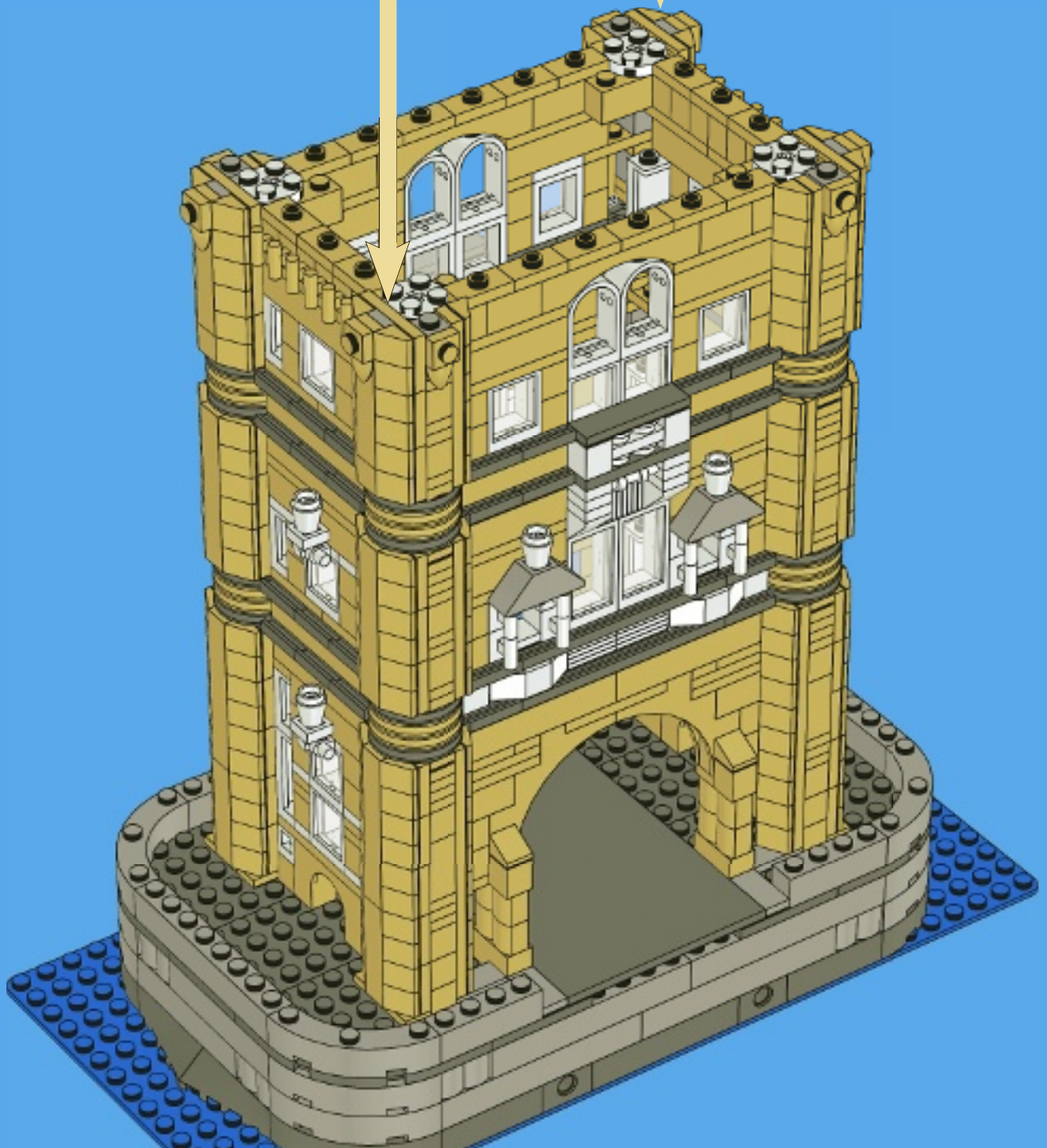

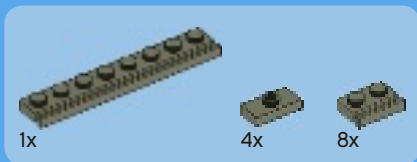

63

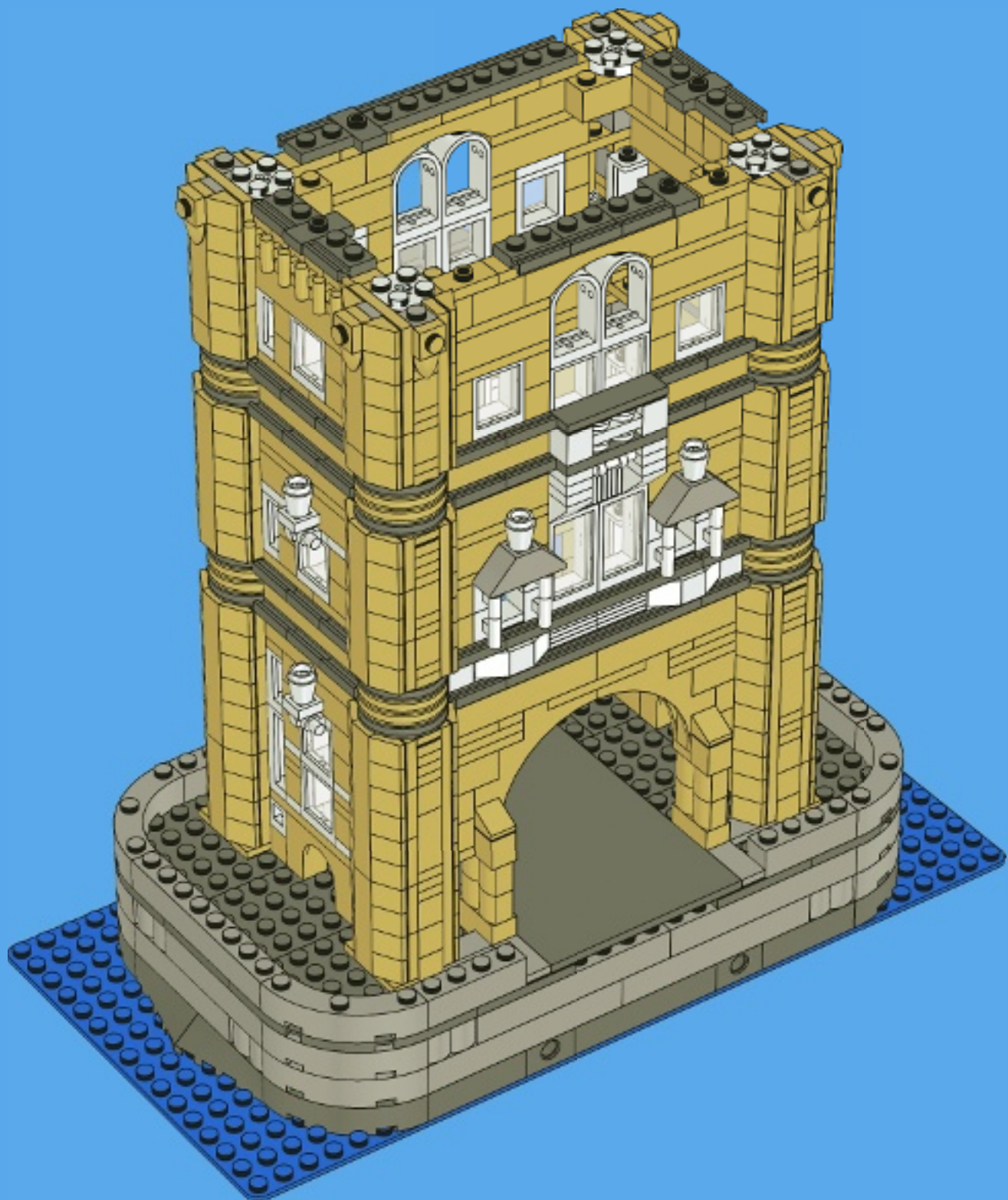



2x



4x

64



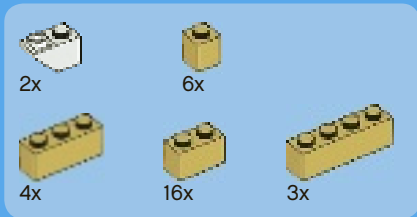

65

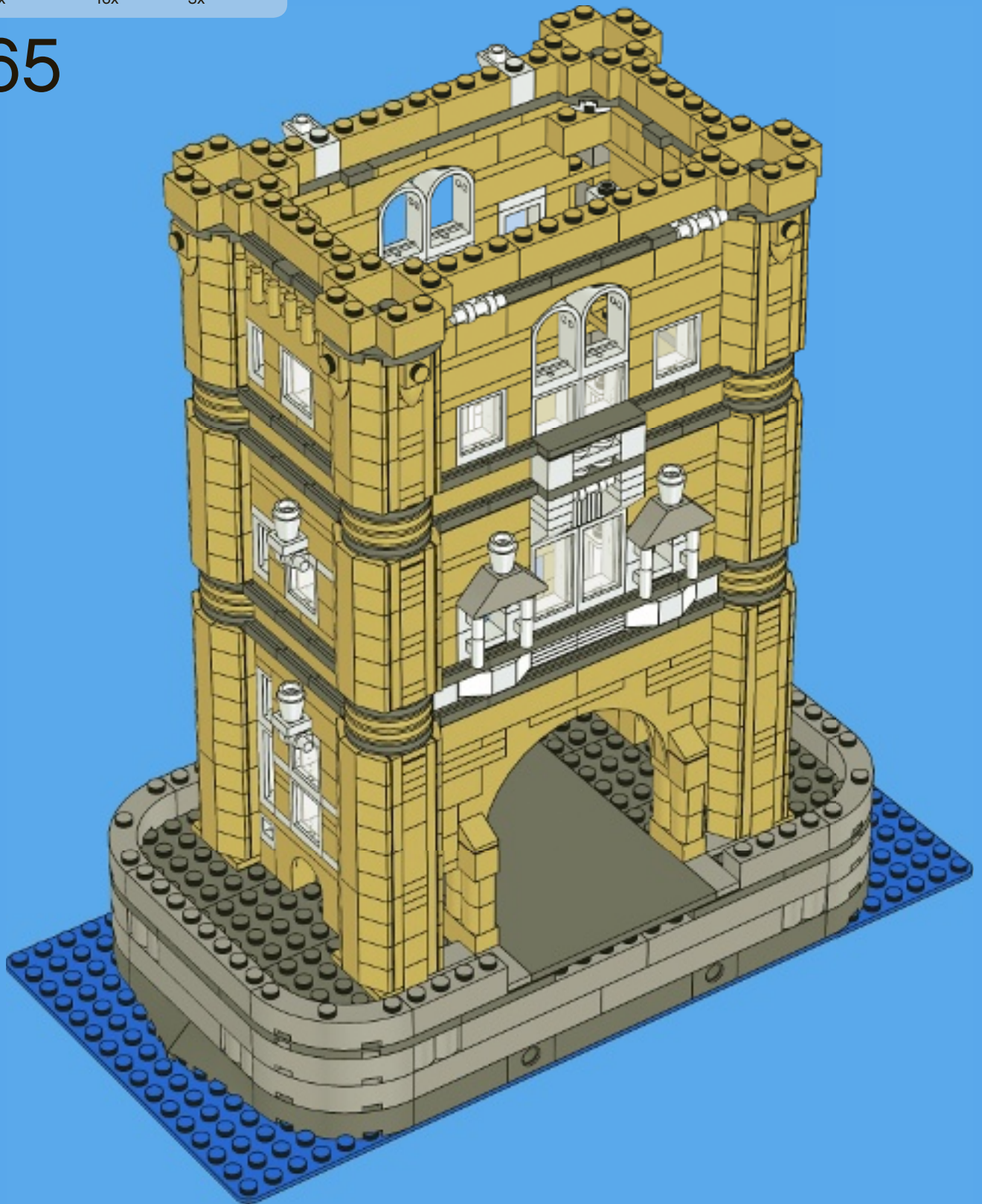

- 4x
- 2x
- 2x
- 4x
- 2x
- 10x

66

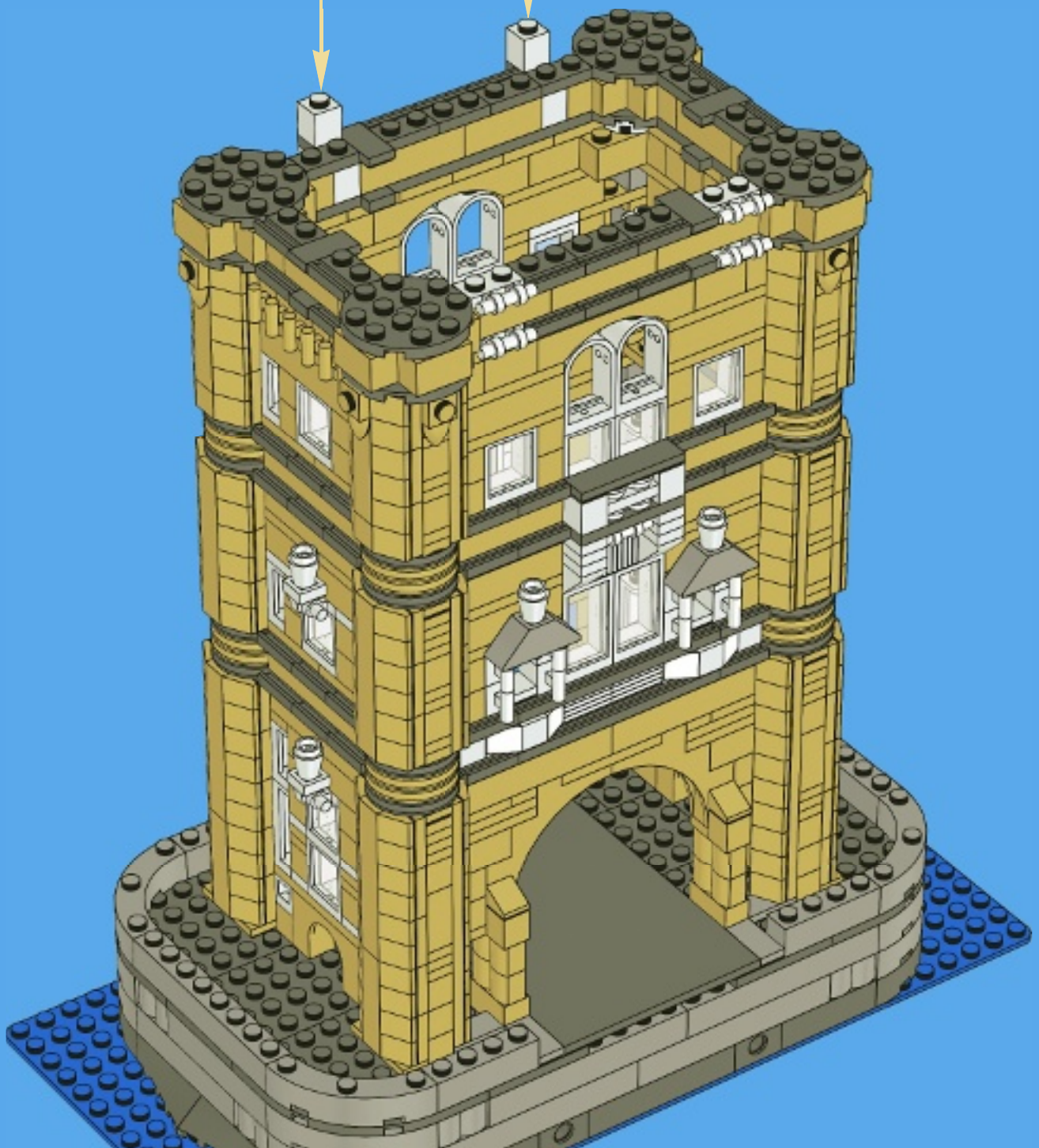
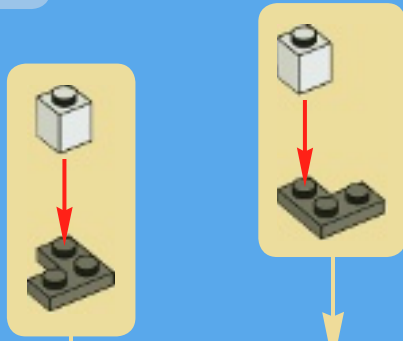

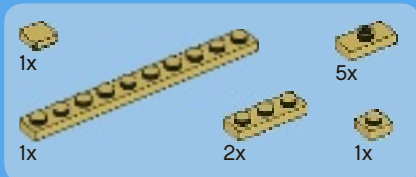

67

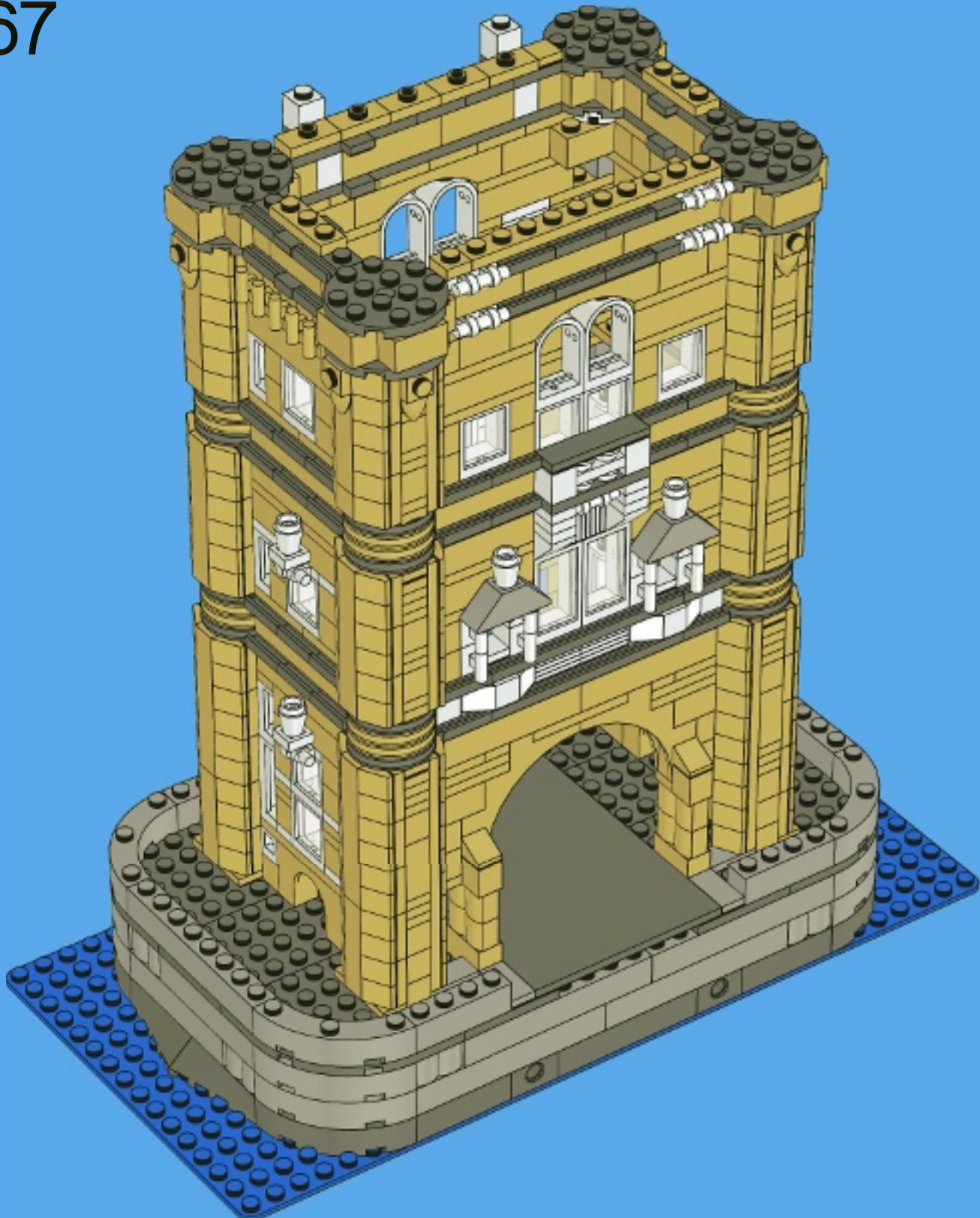



2x



2x



8x



2x

68

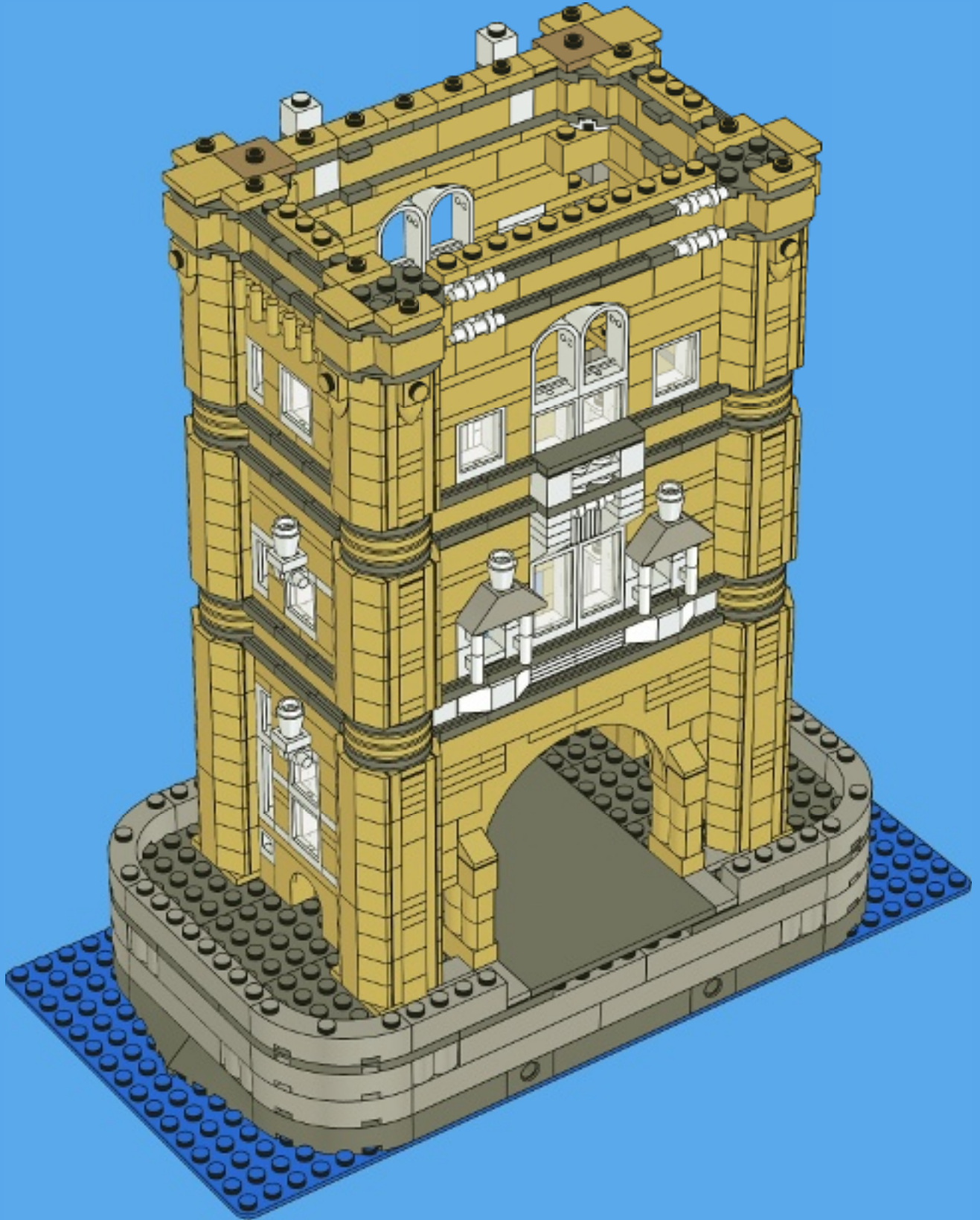

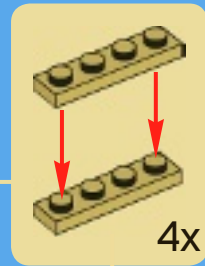
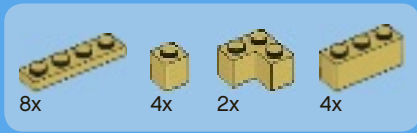

69

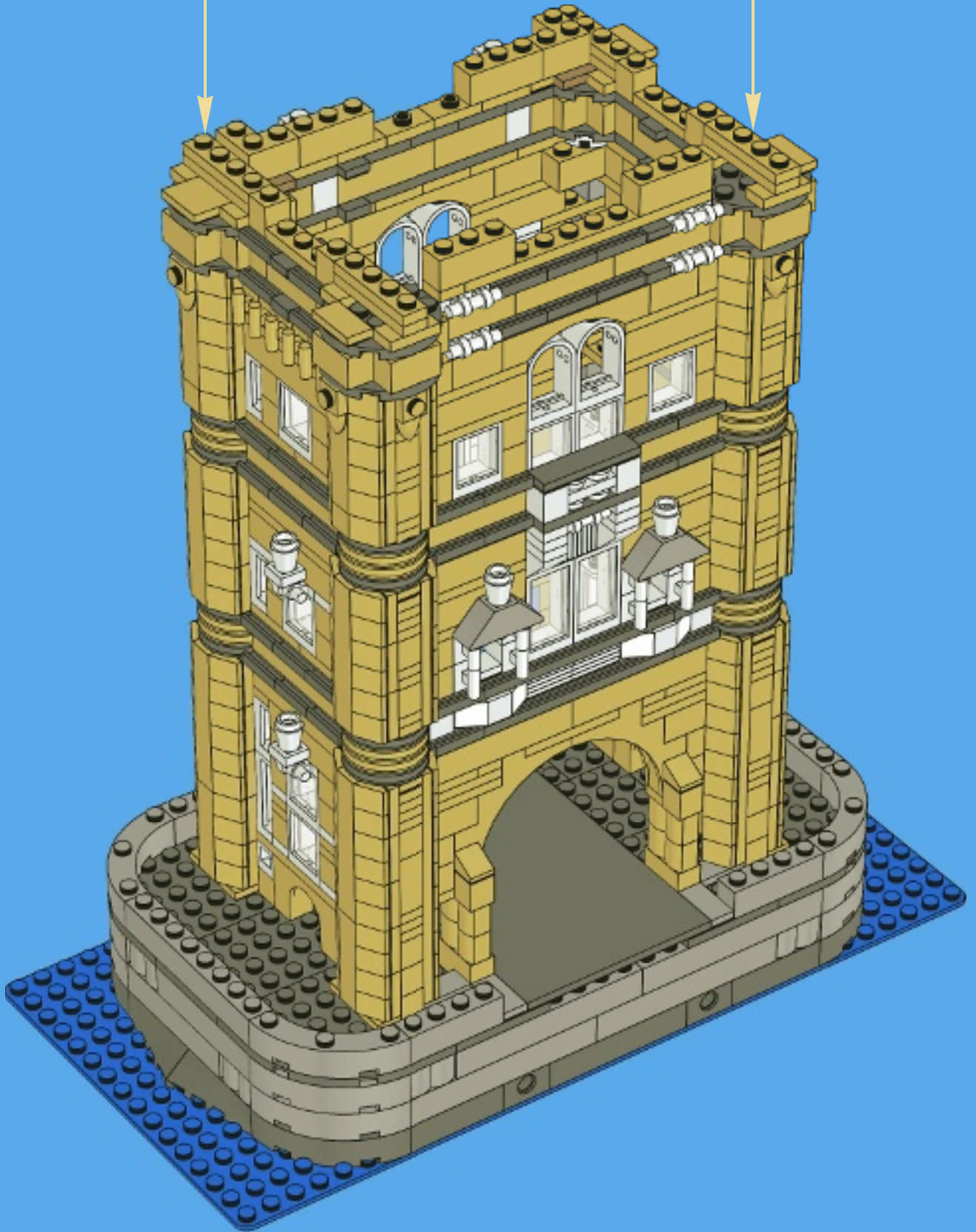

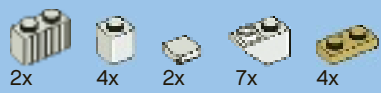

70

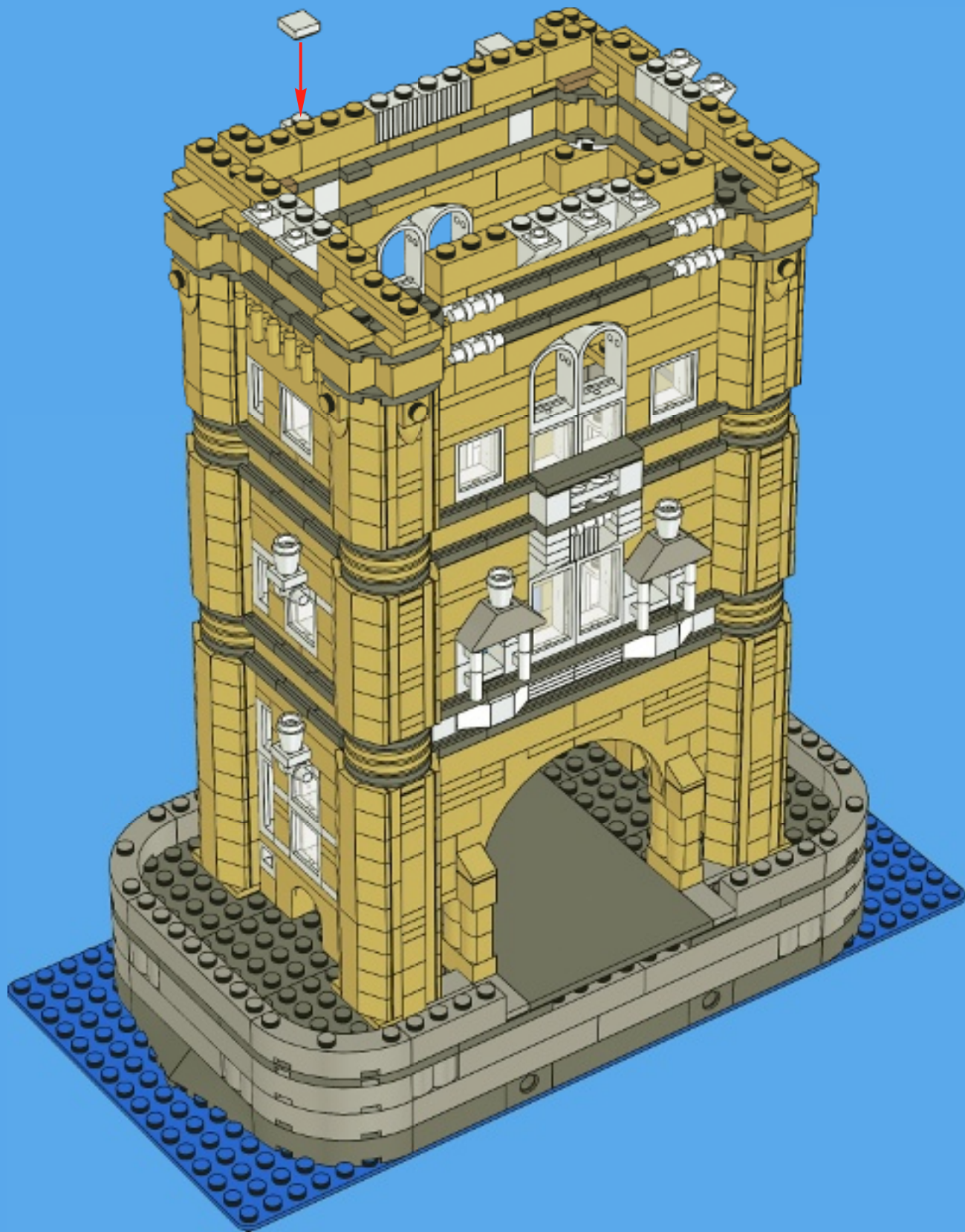

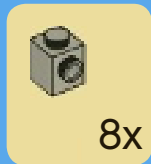
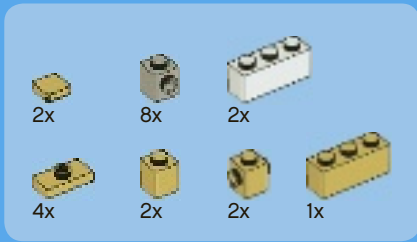

71





2x



8x

72

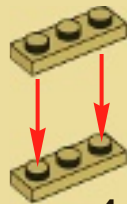

4x

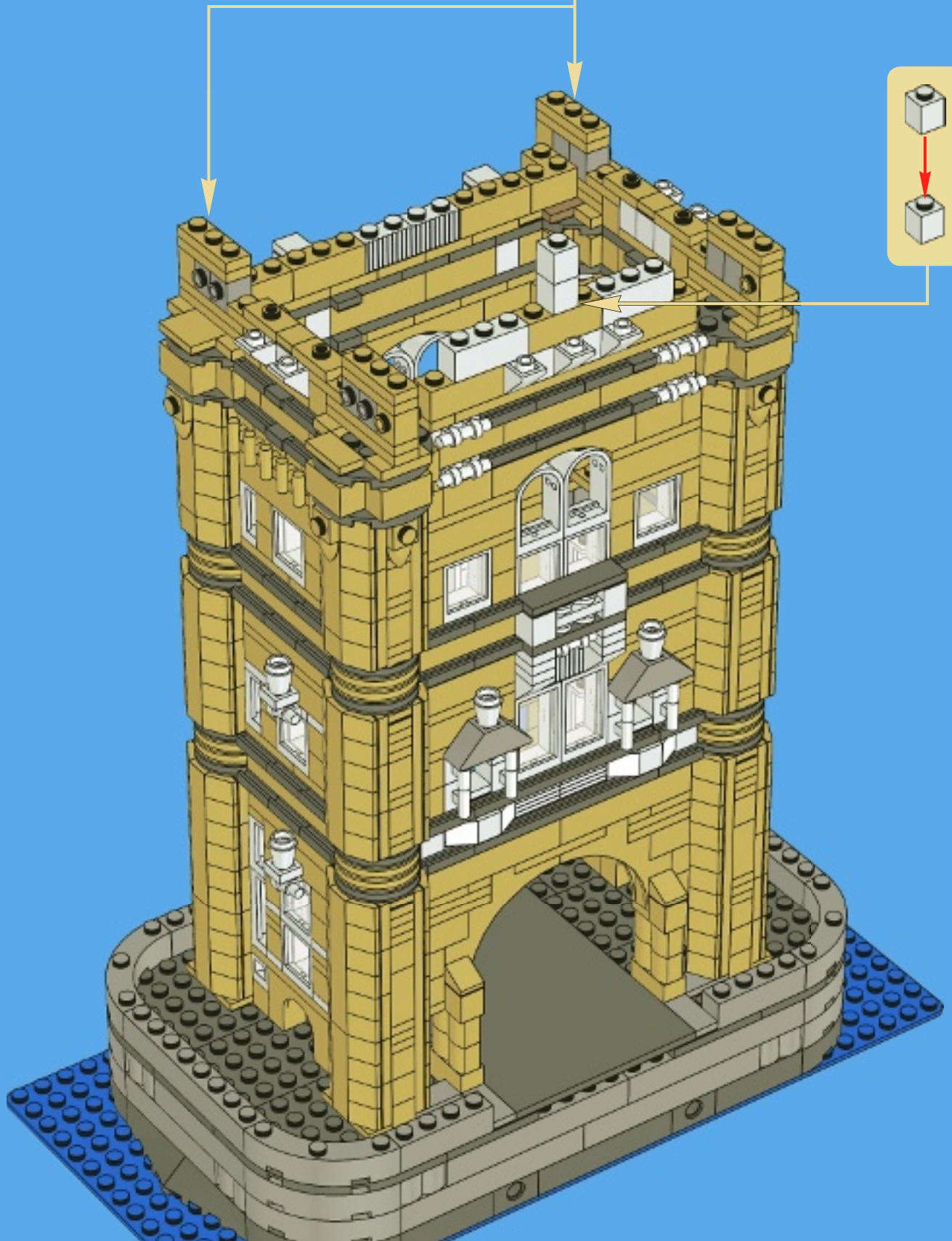

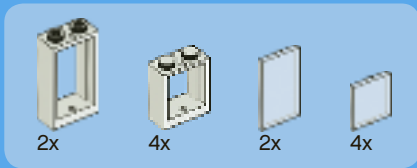

73

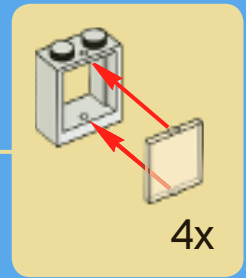
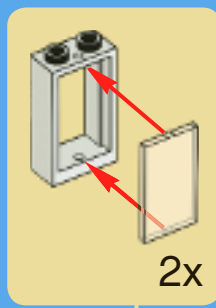



14x



2x



8x

74



4x





75



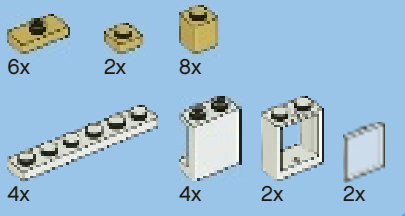

76

1

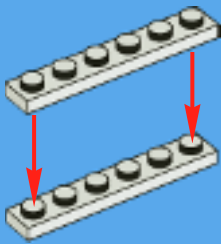

2

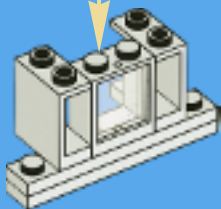
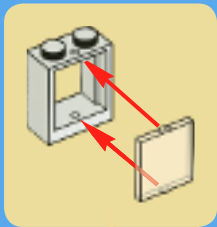

3

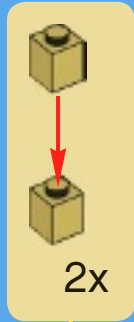

2x

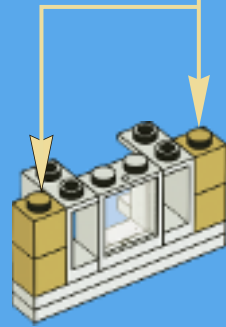

4

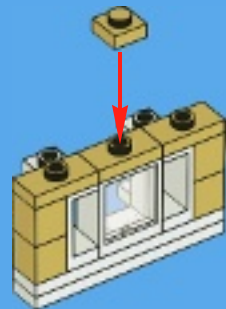

2x

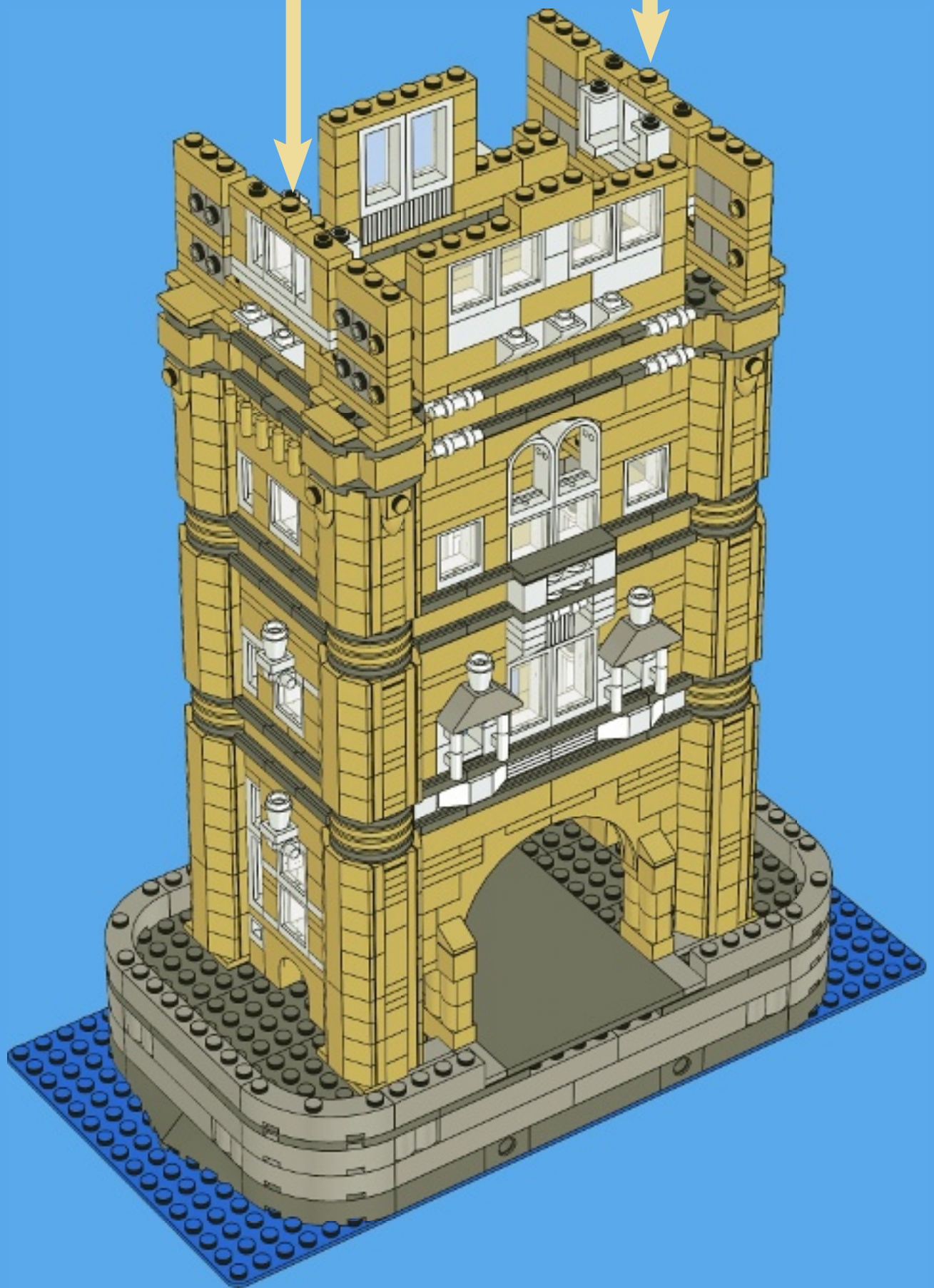

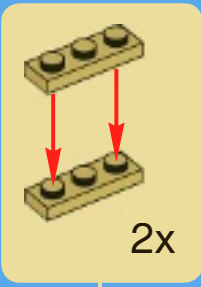
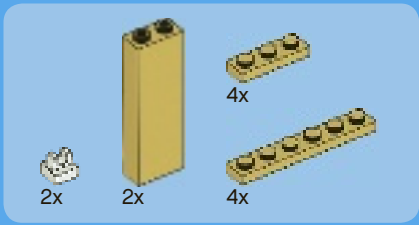

77





2x



2x



8x



4x

78

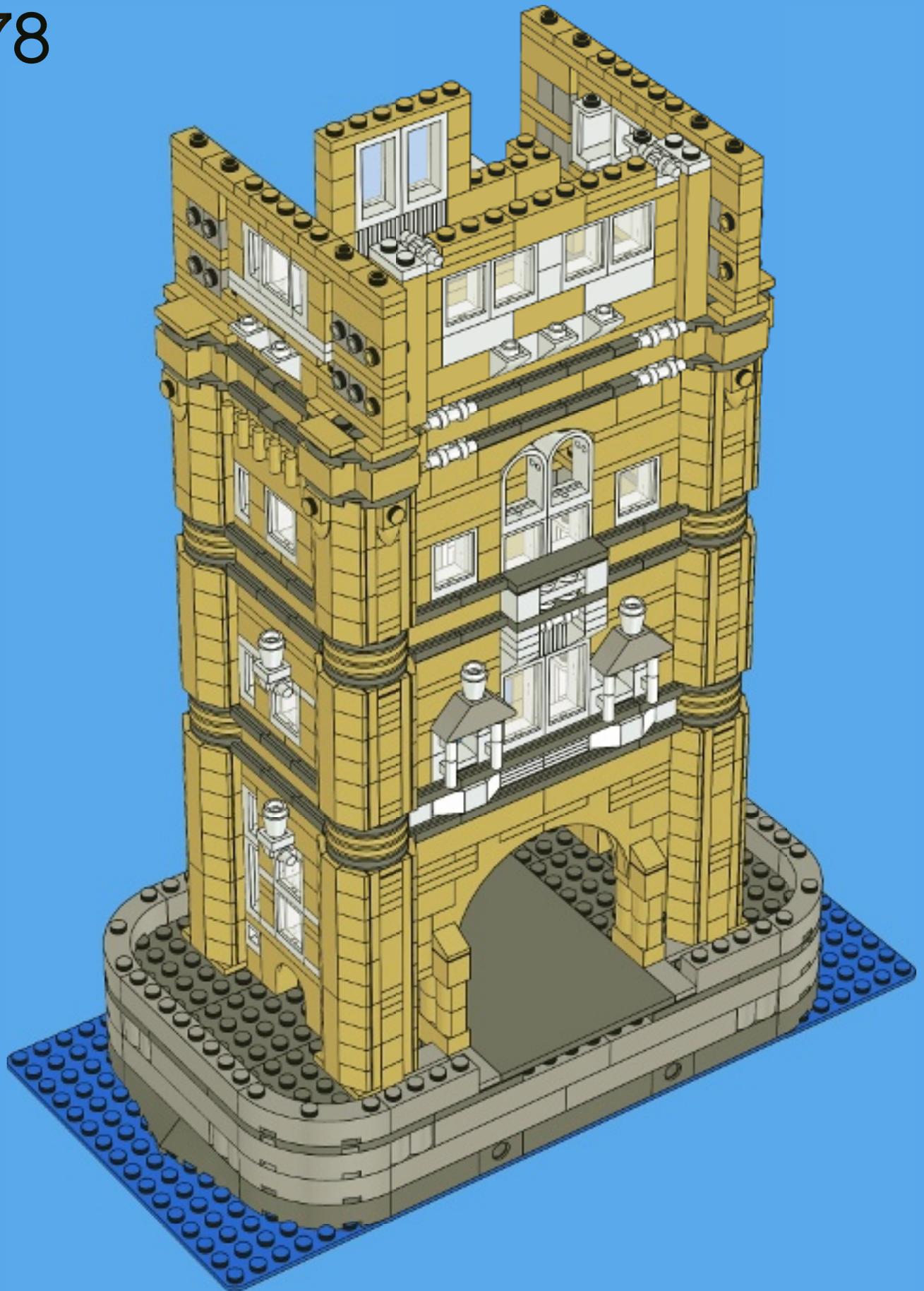



79

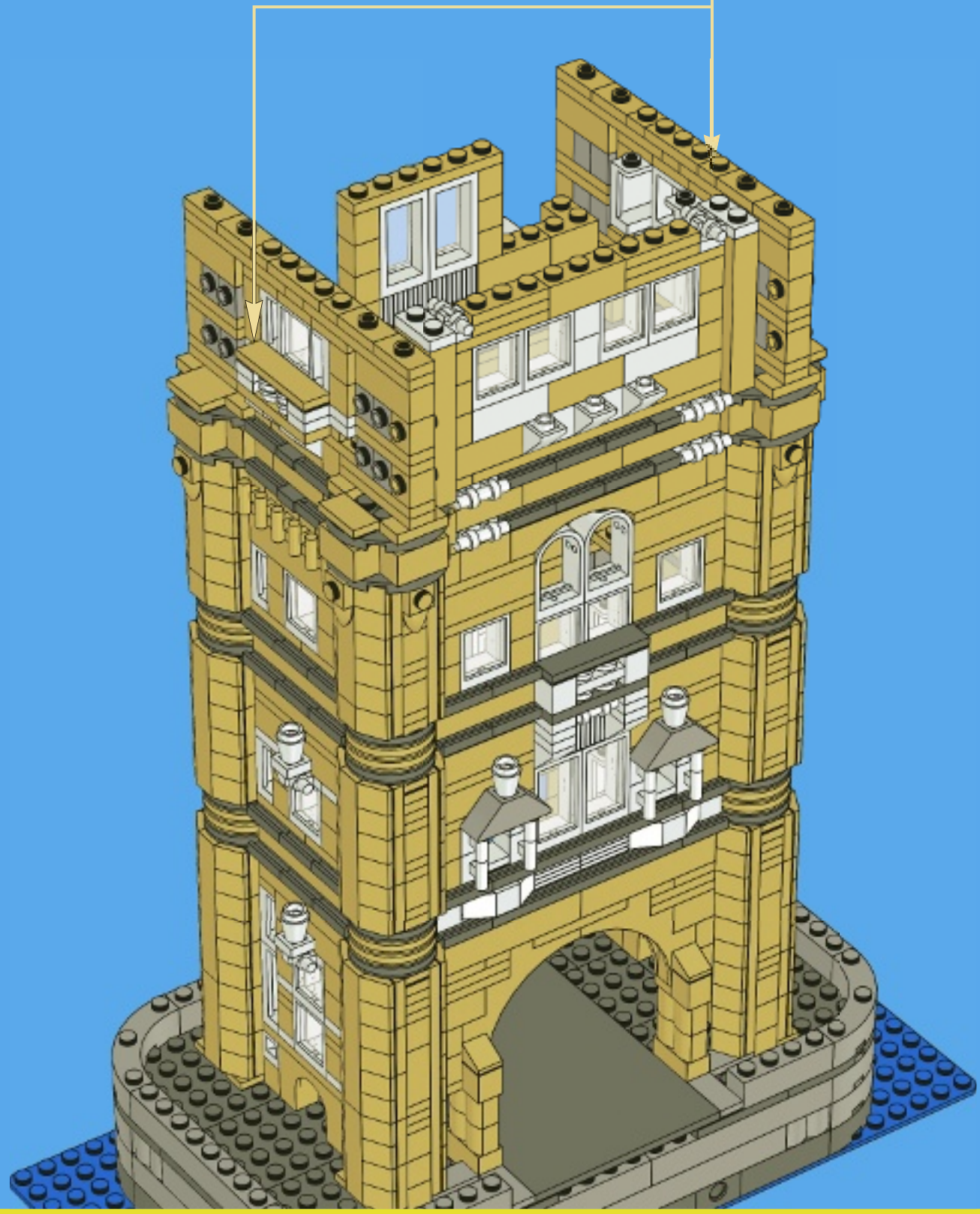
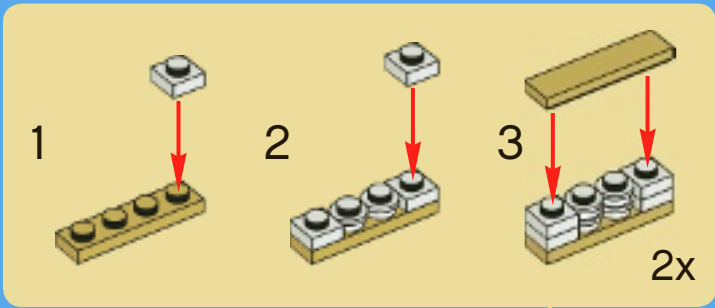

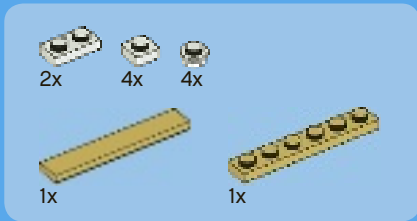

80

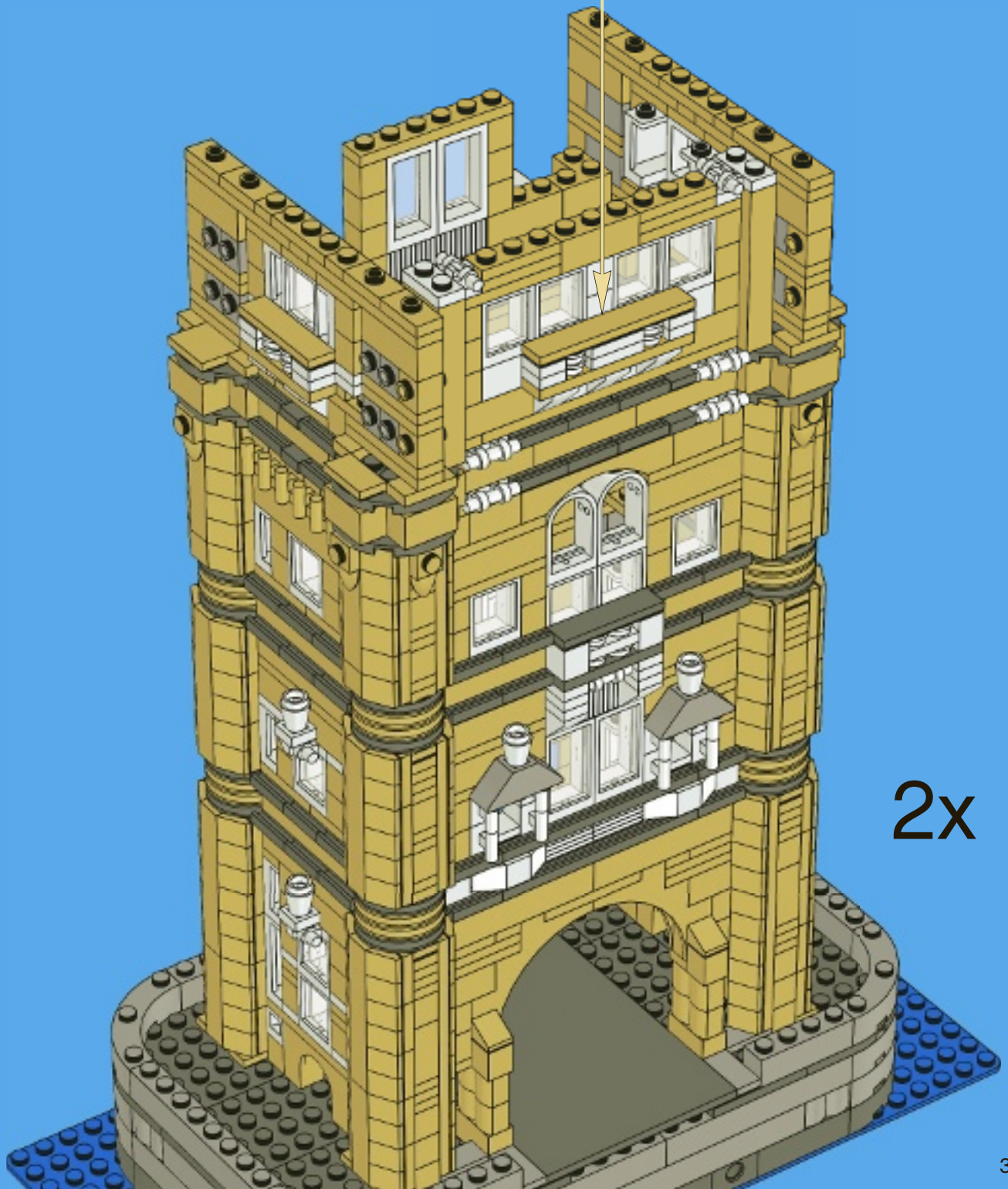
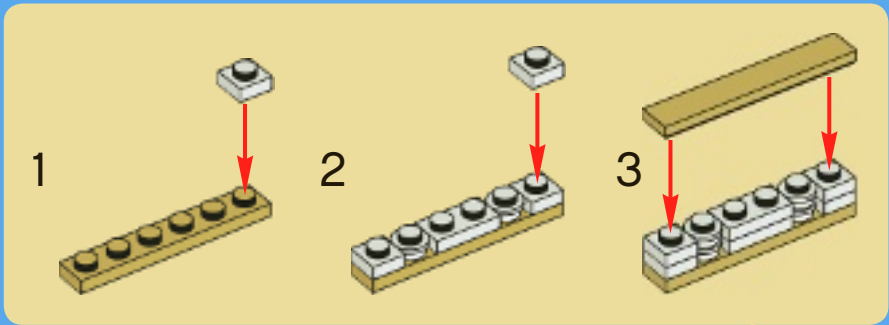

81

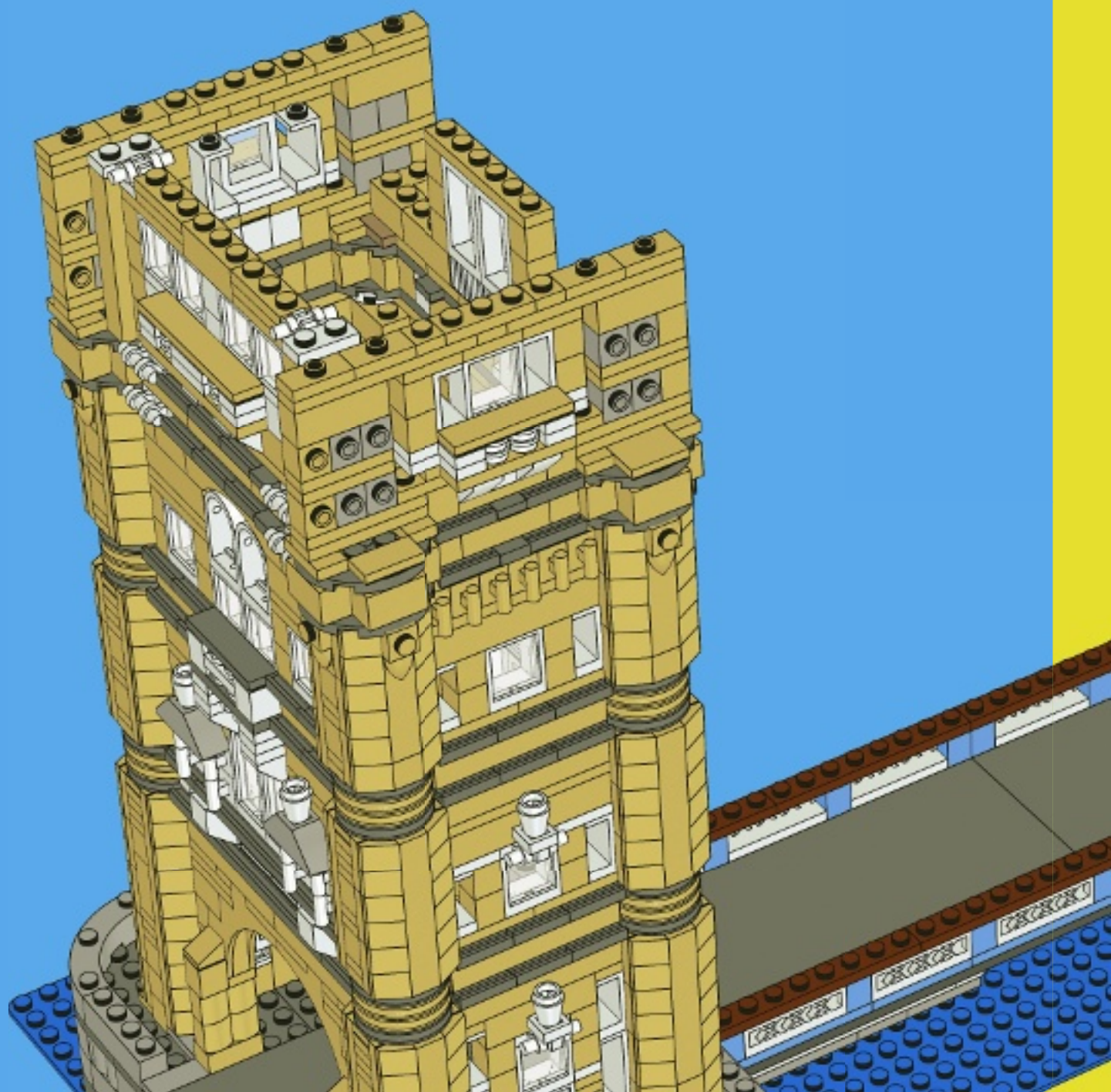

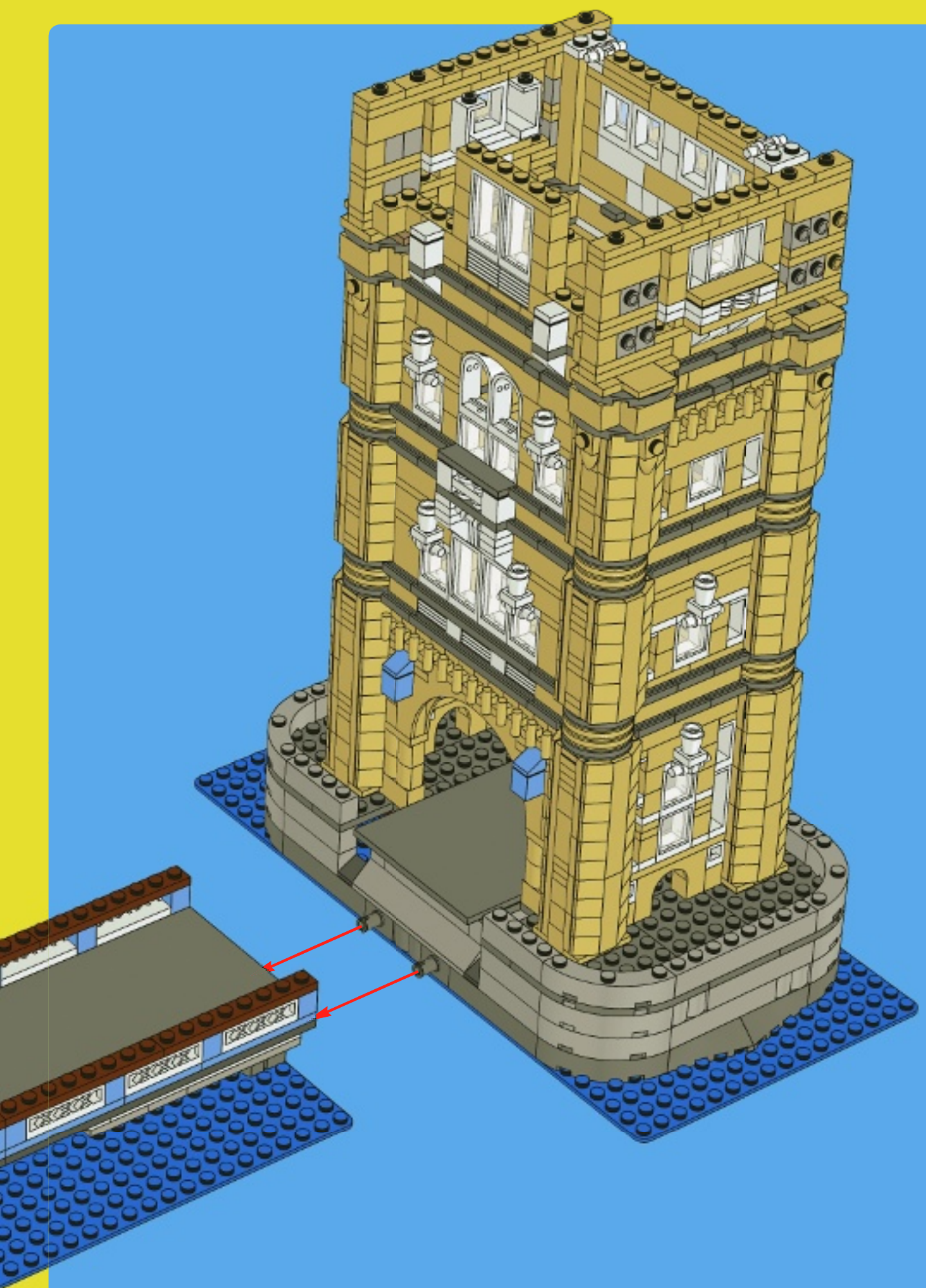

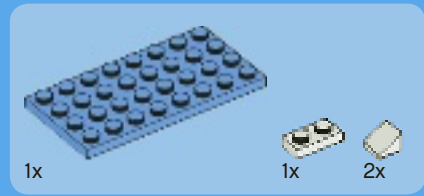
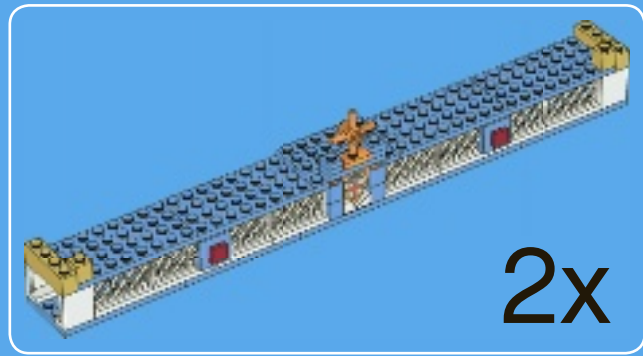

1

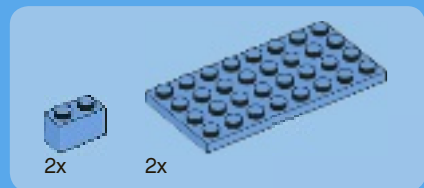

2

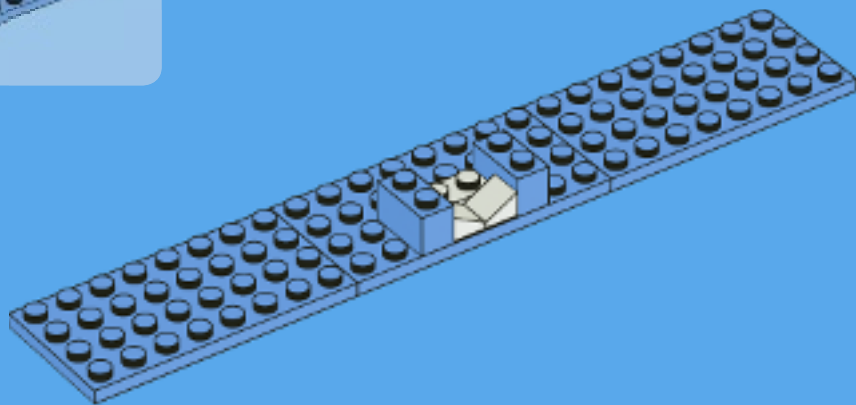

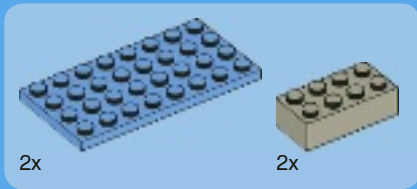

3

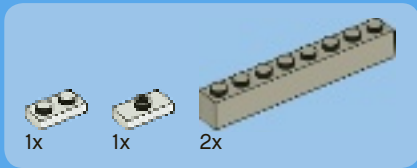
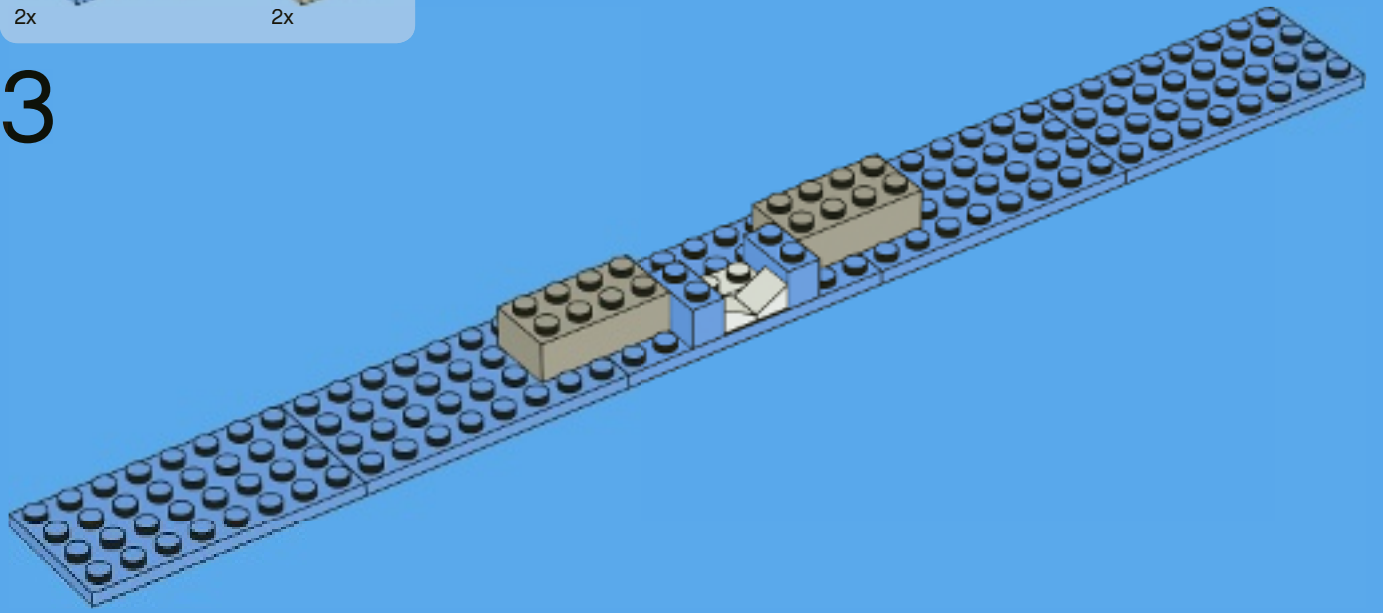

4

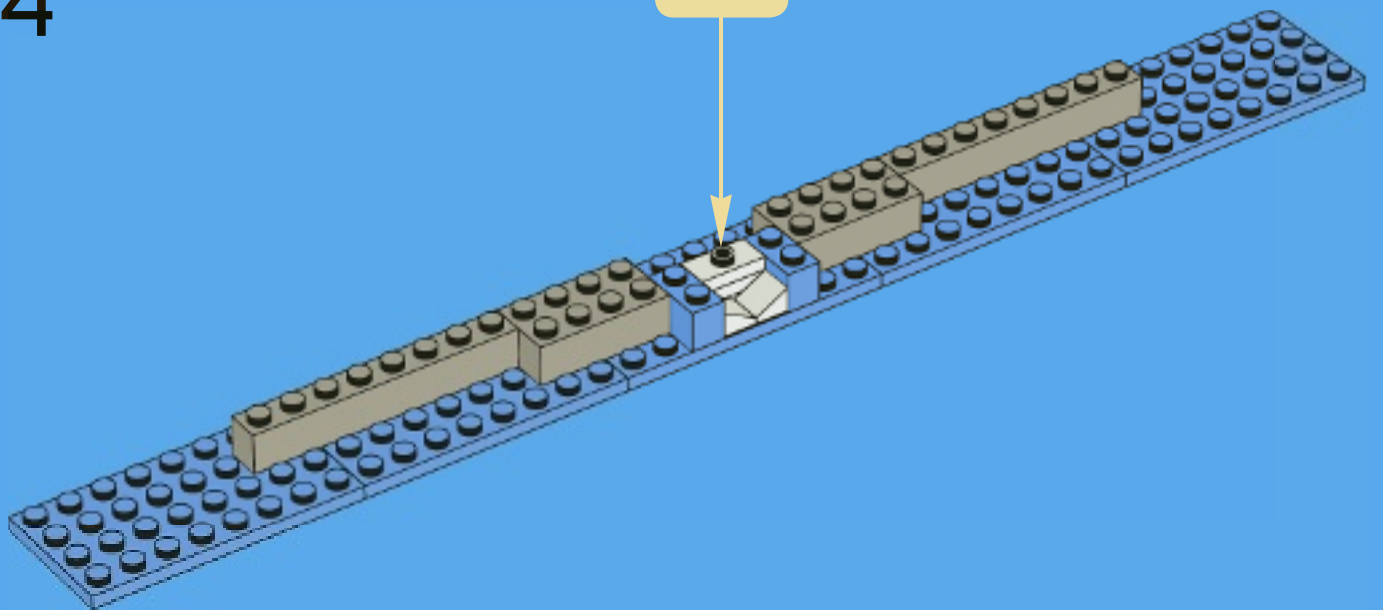
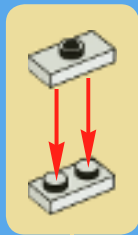

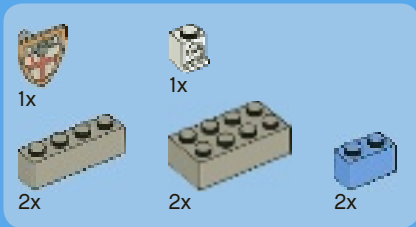

5

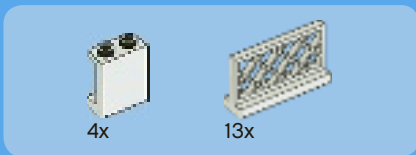
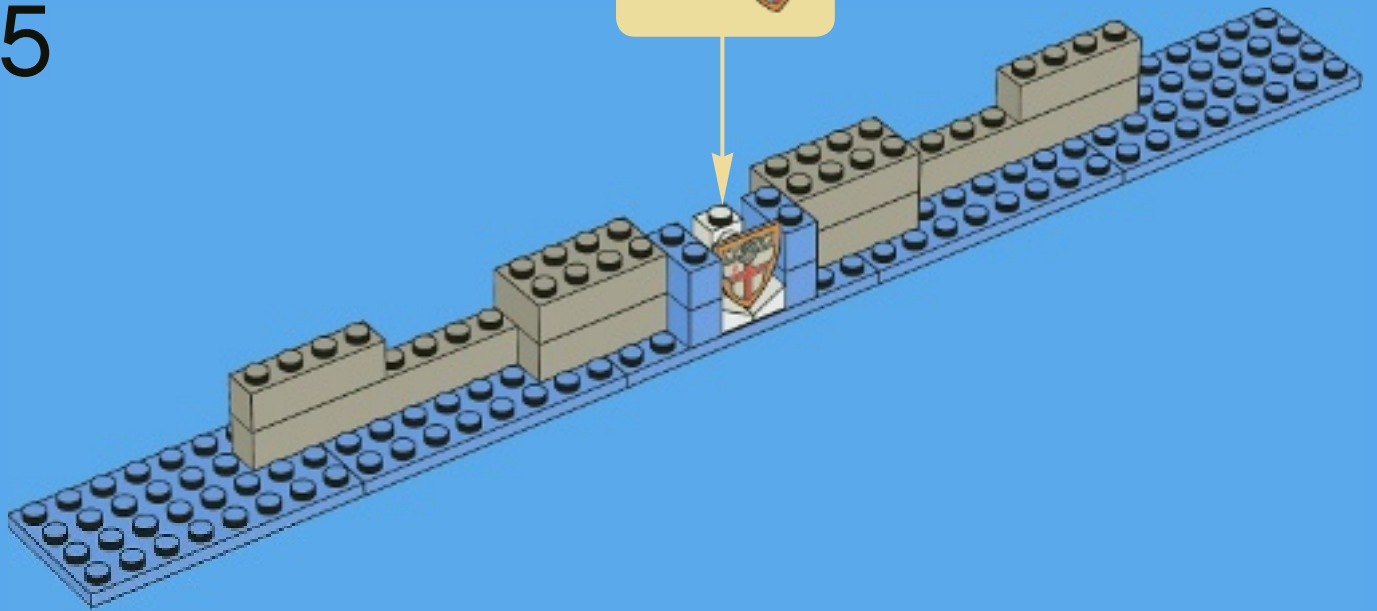
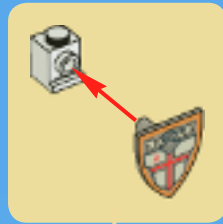

6

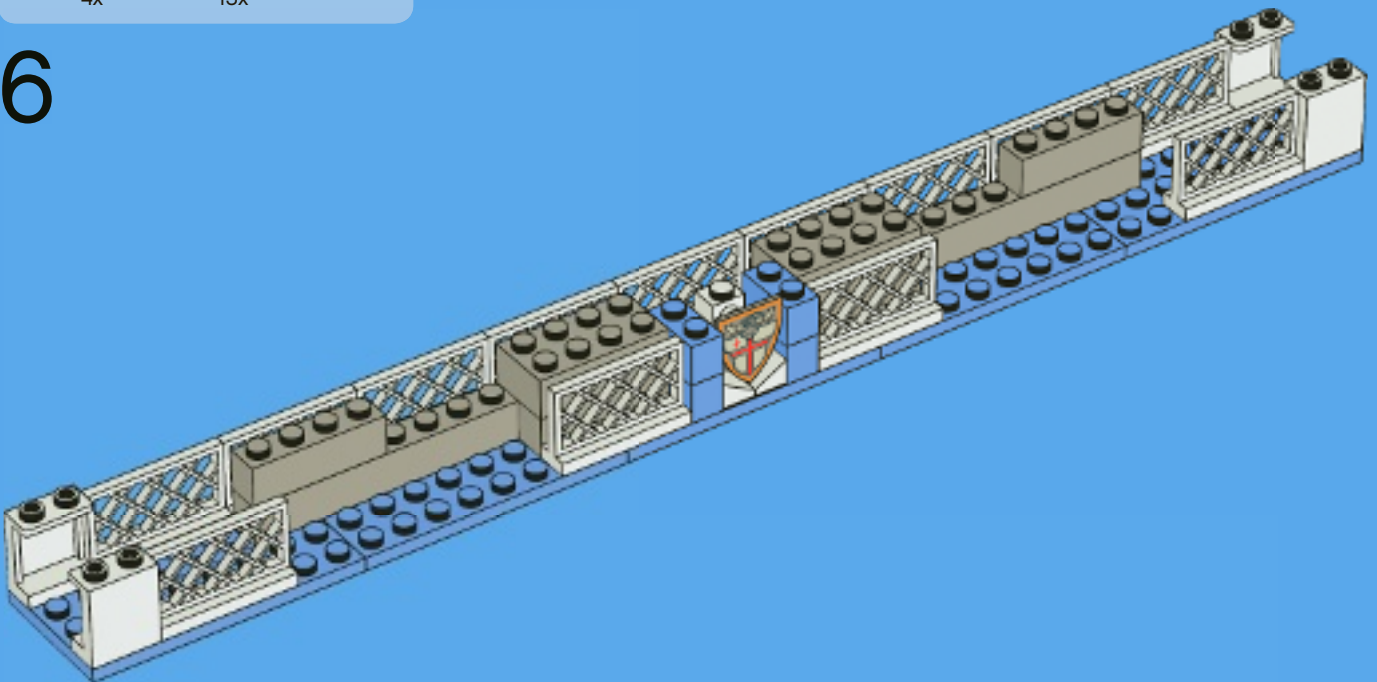

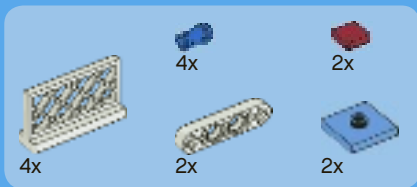

7

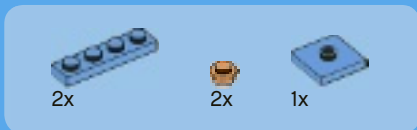
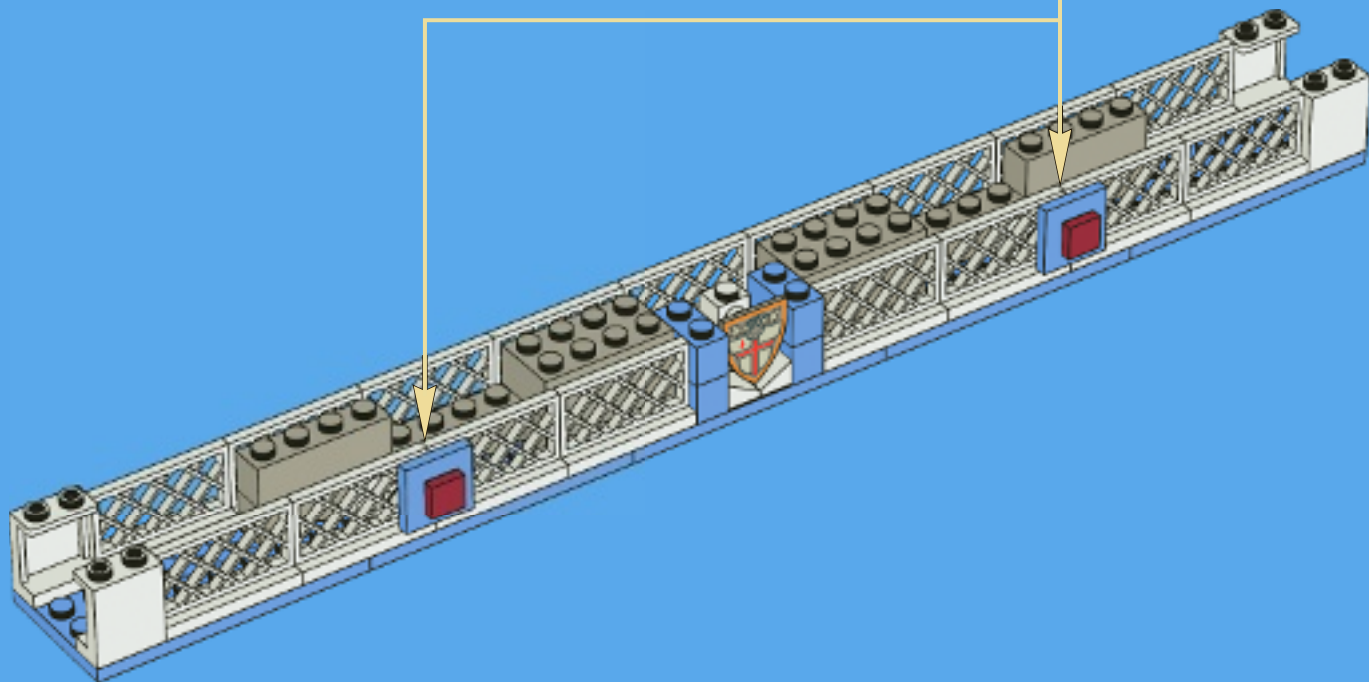
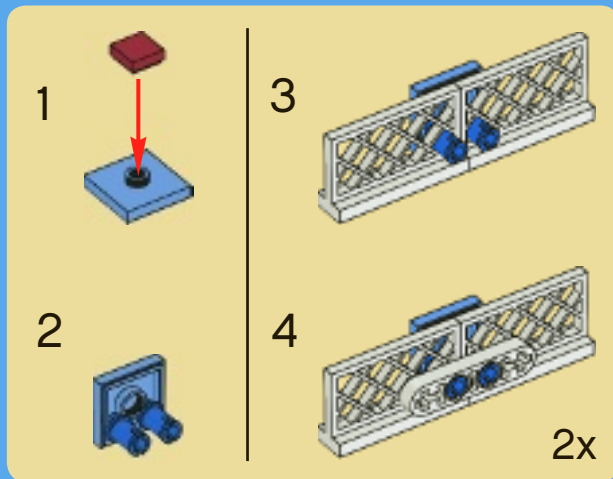

8

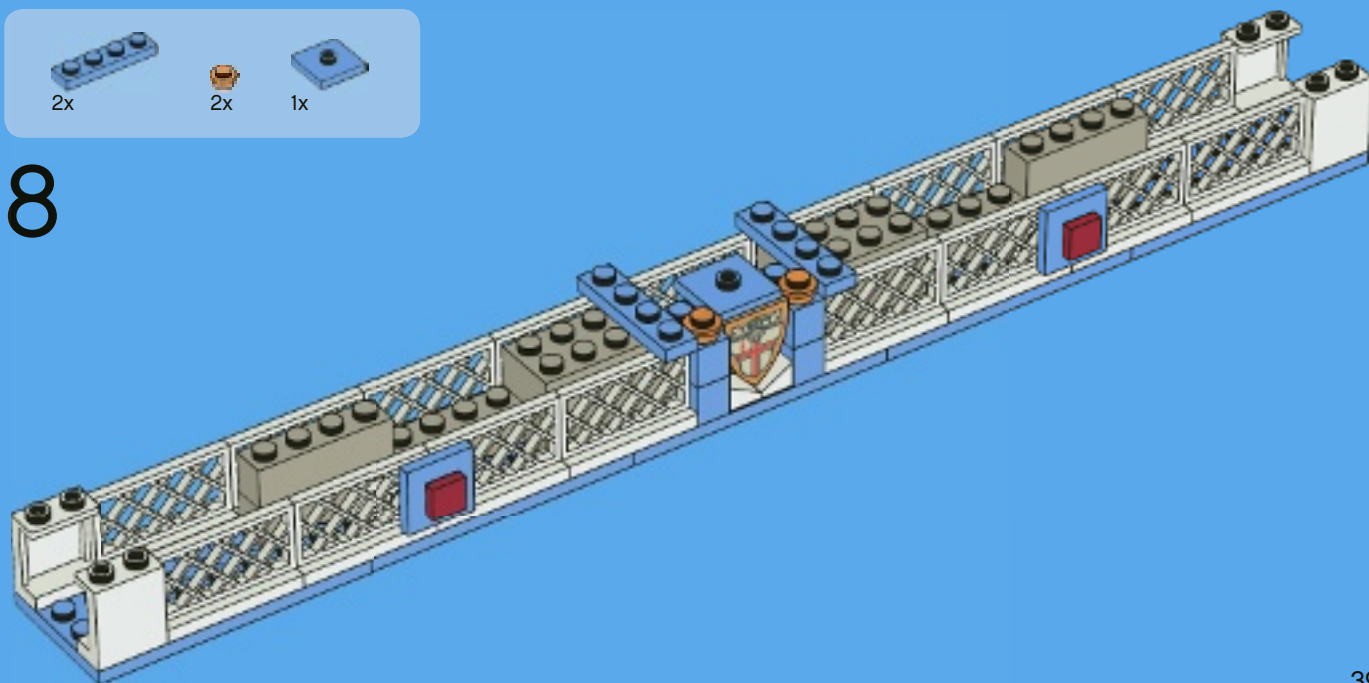

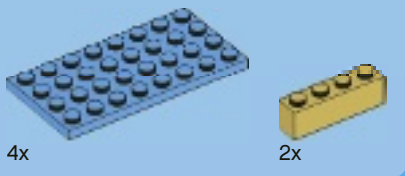

9

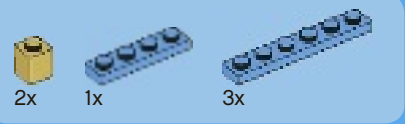
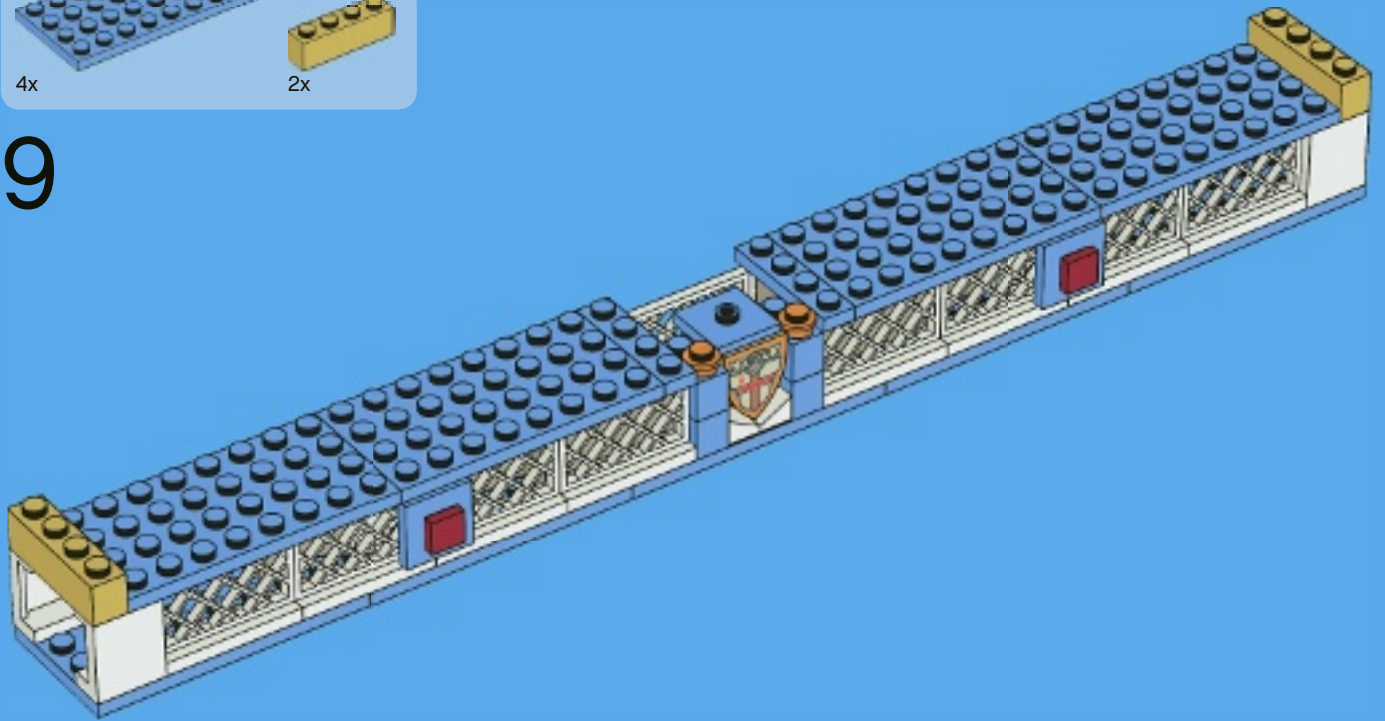

10

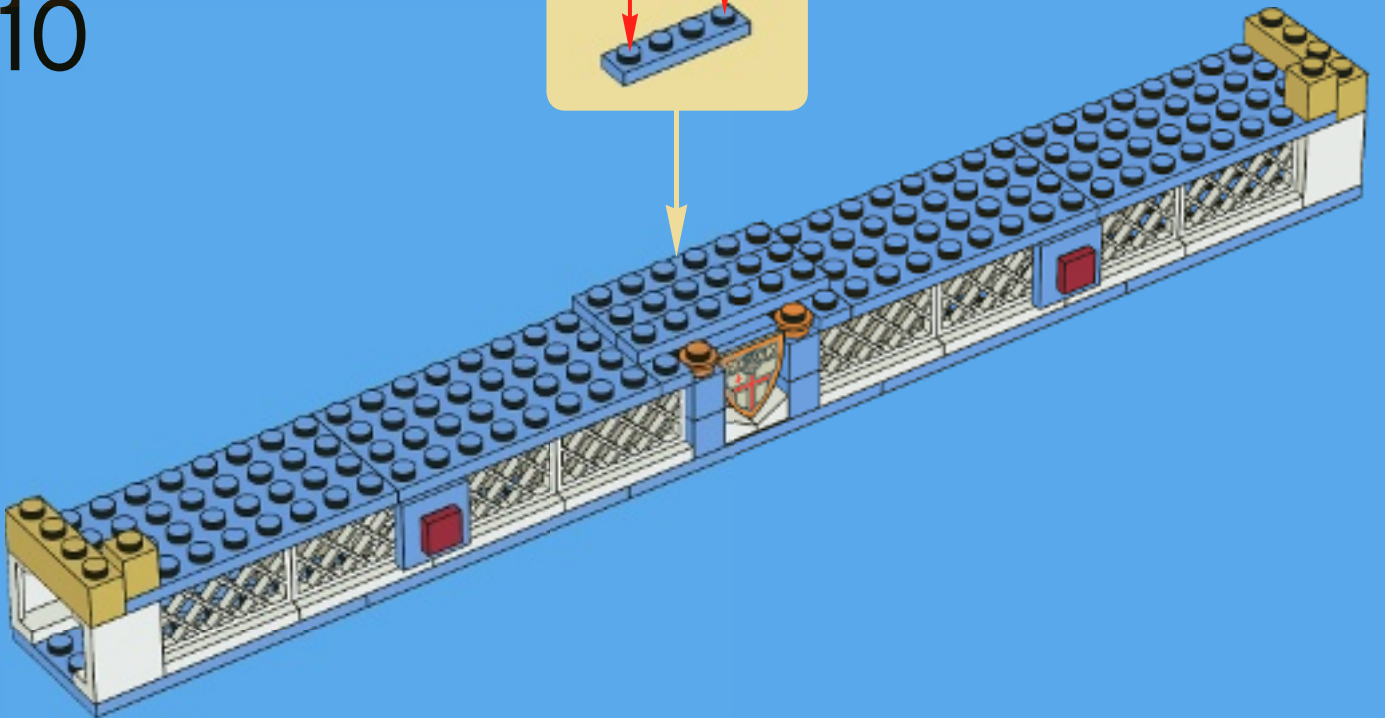
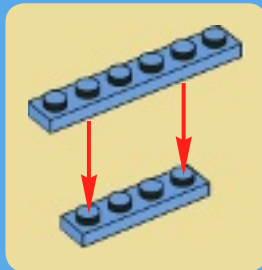



11

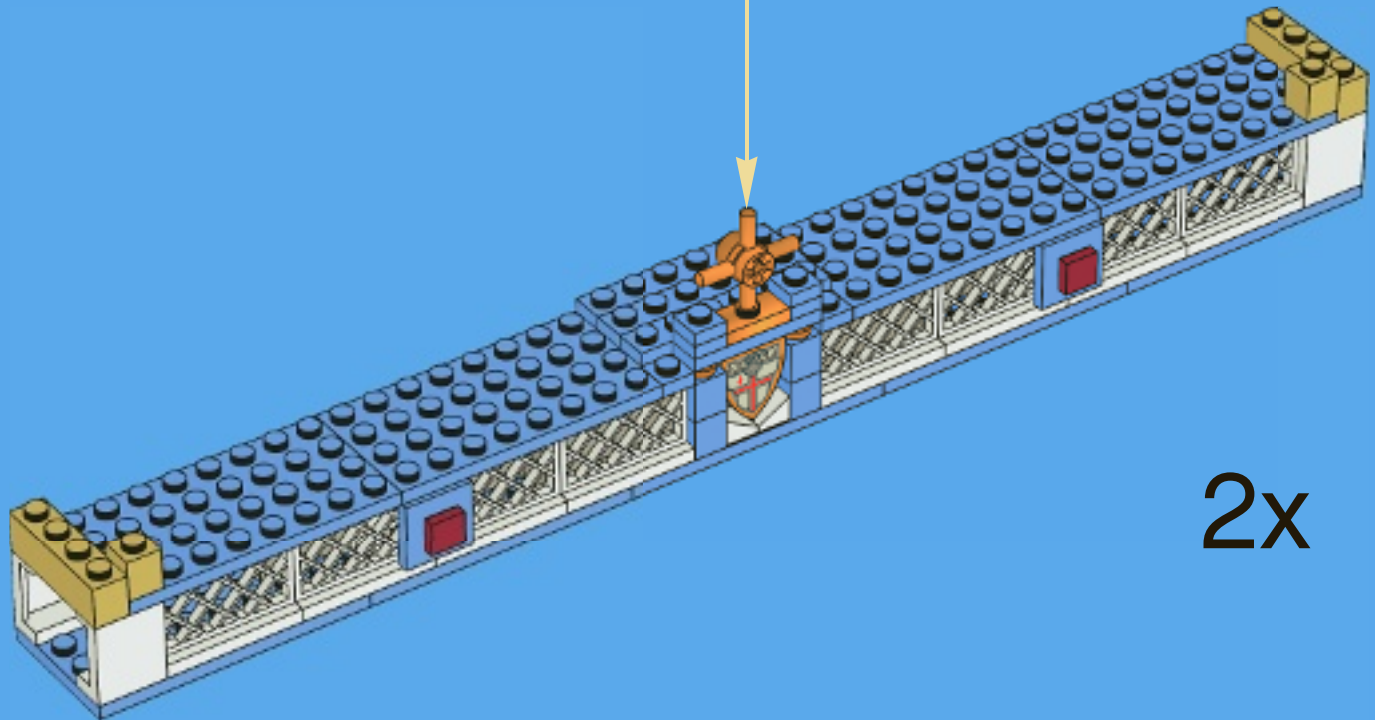
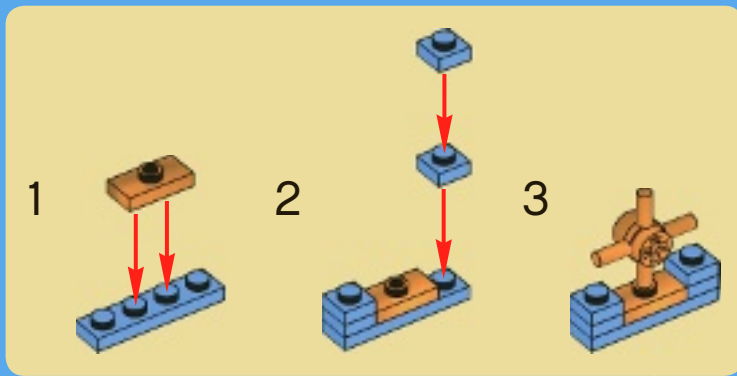

2x

12

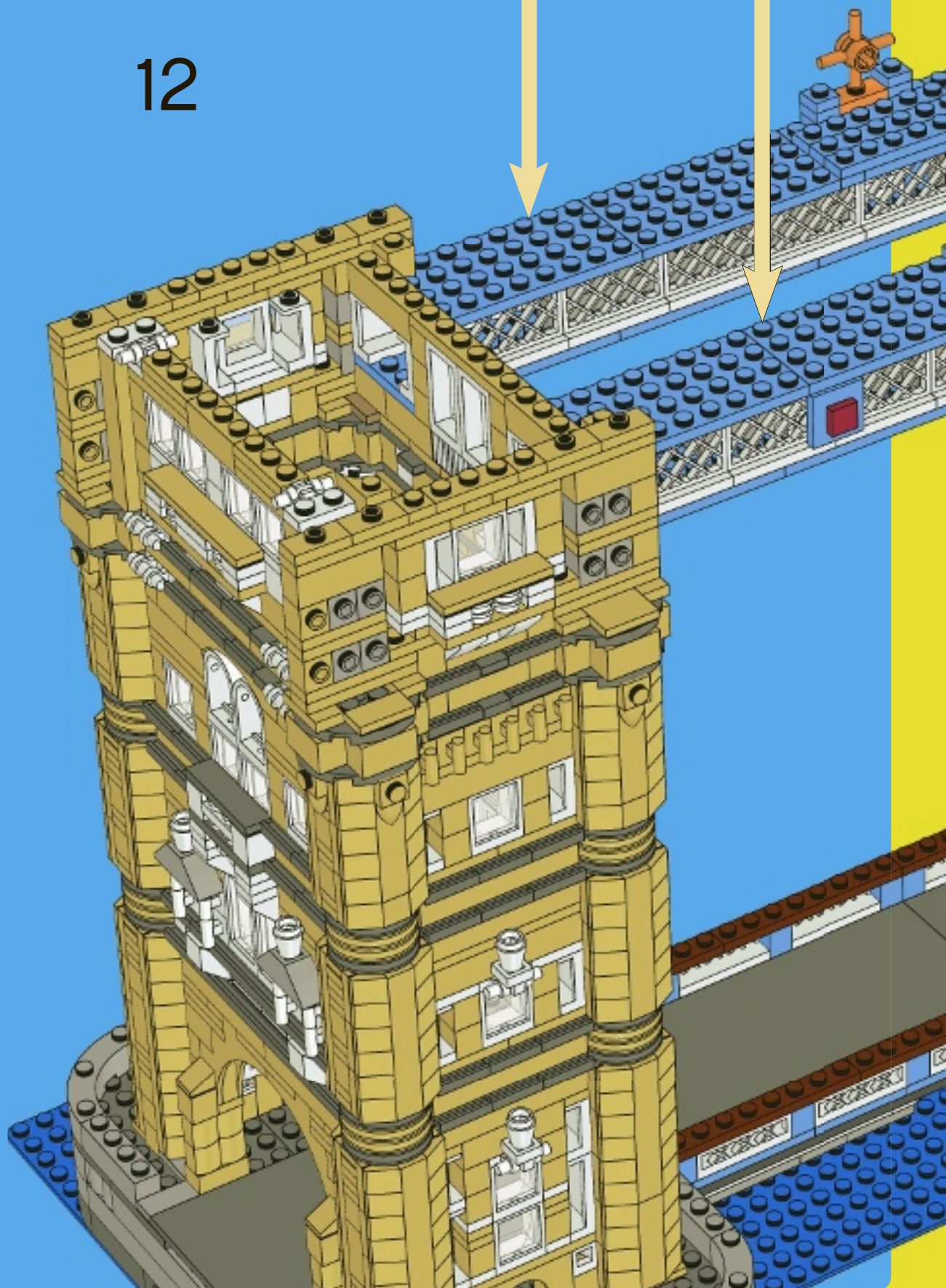

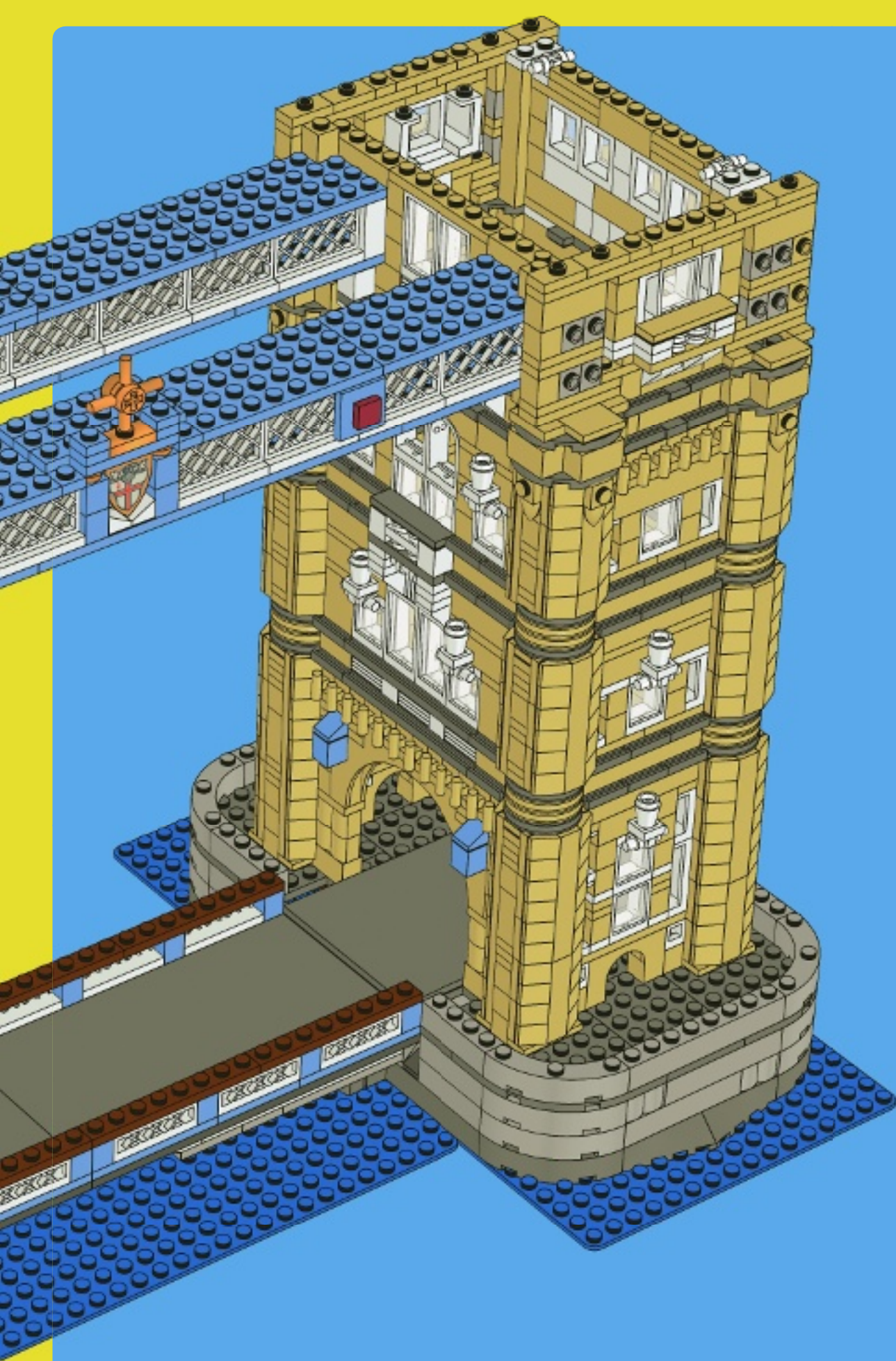



2x



4x

13

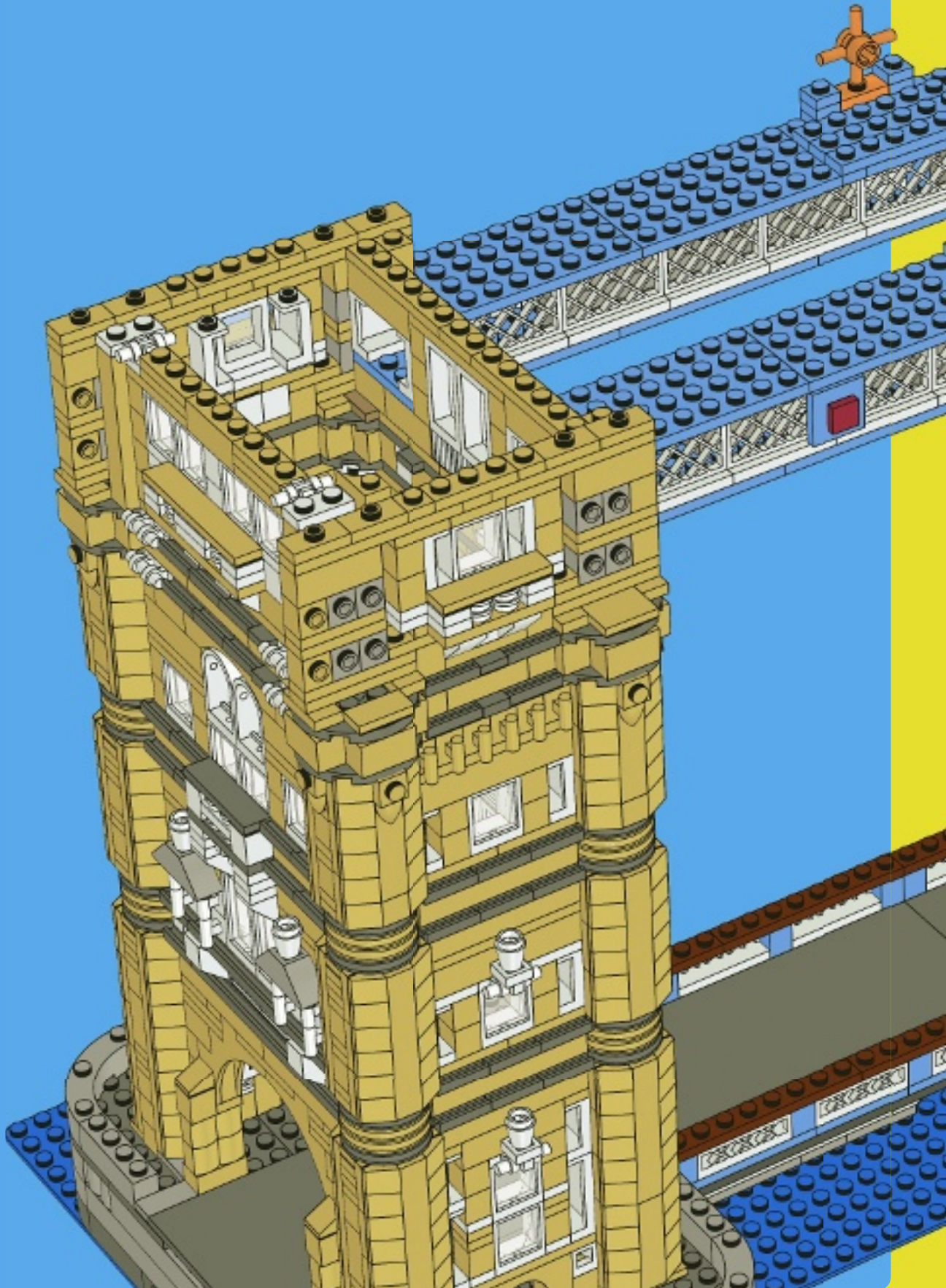

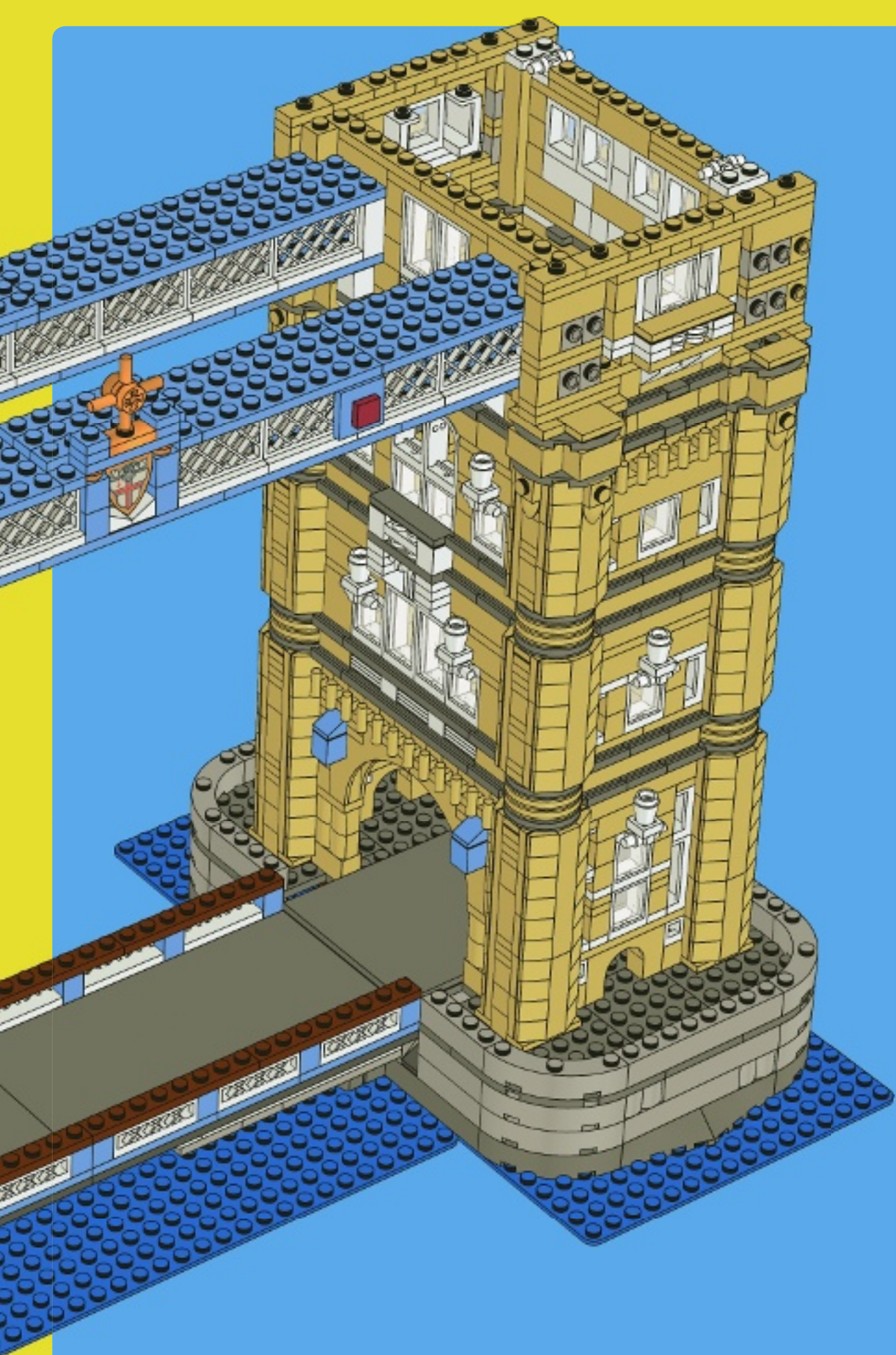



4x



12x

14

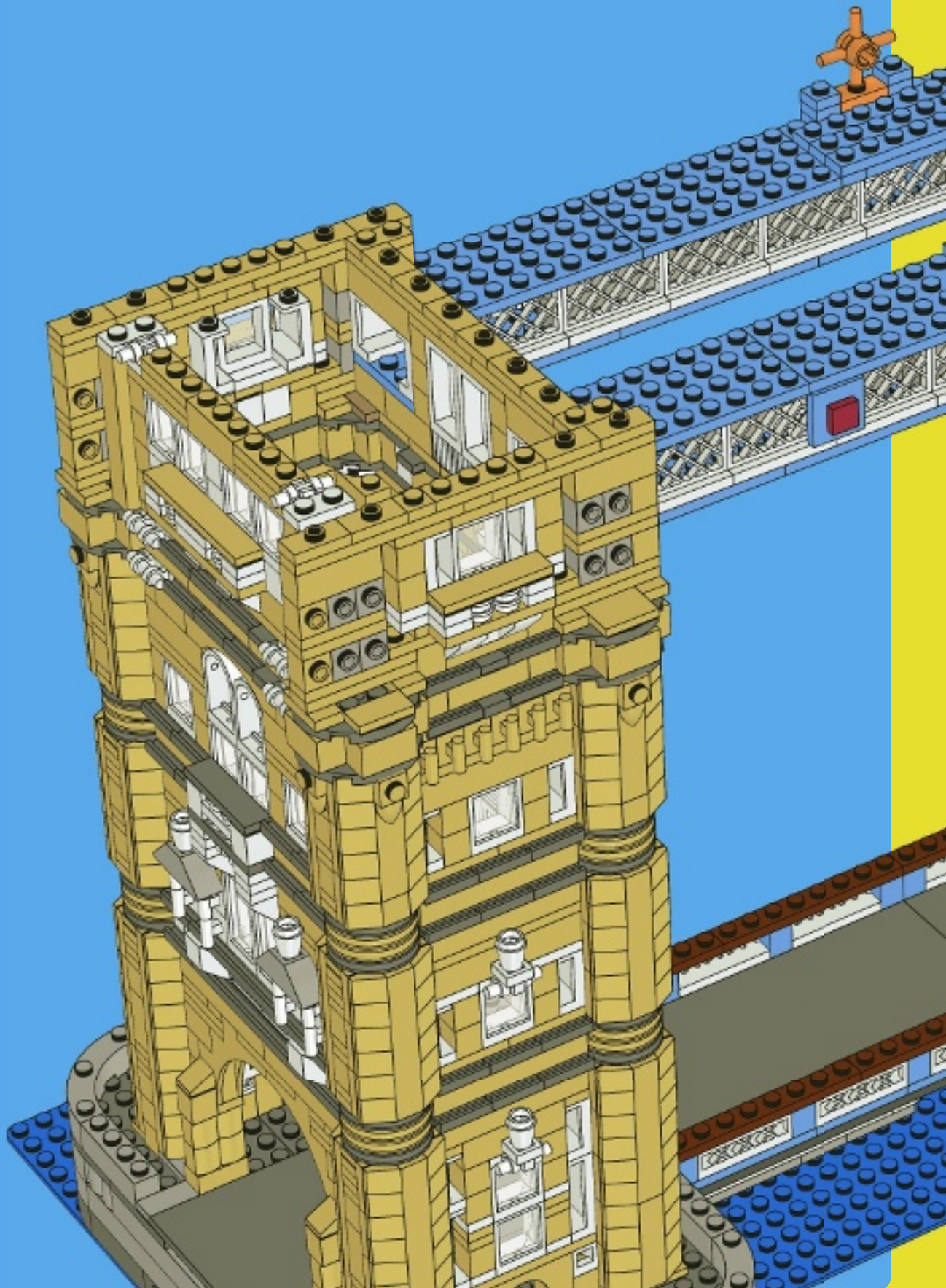

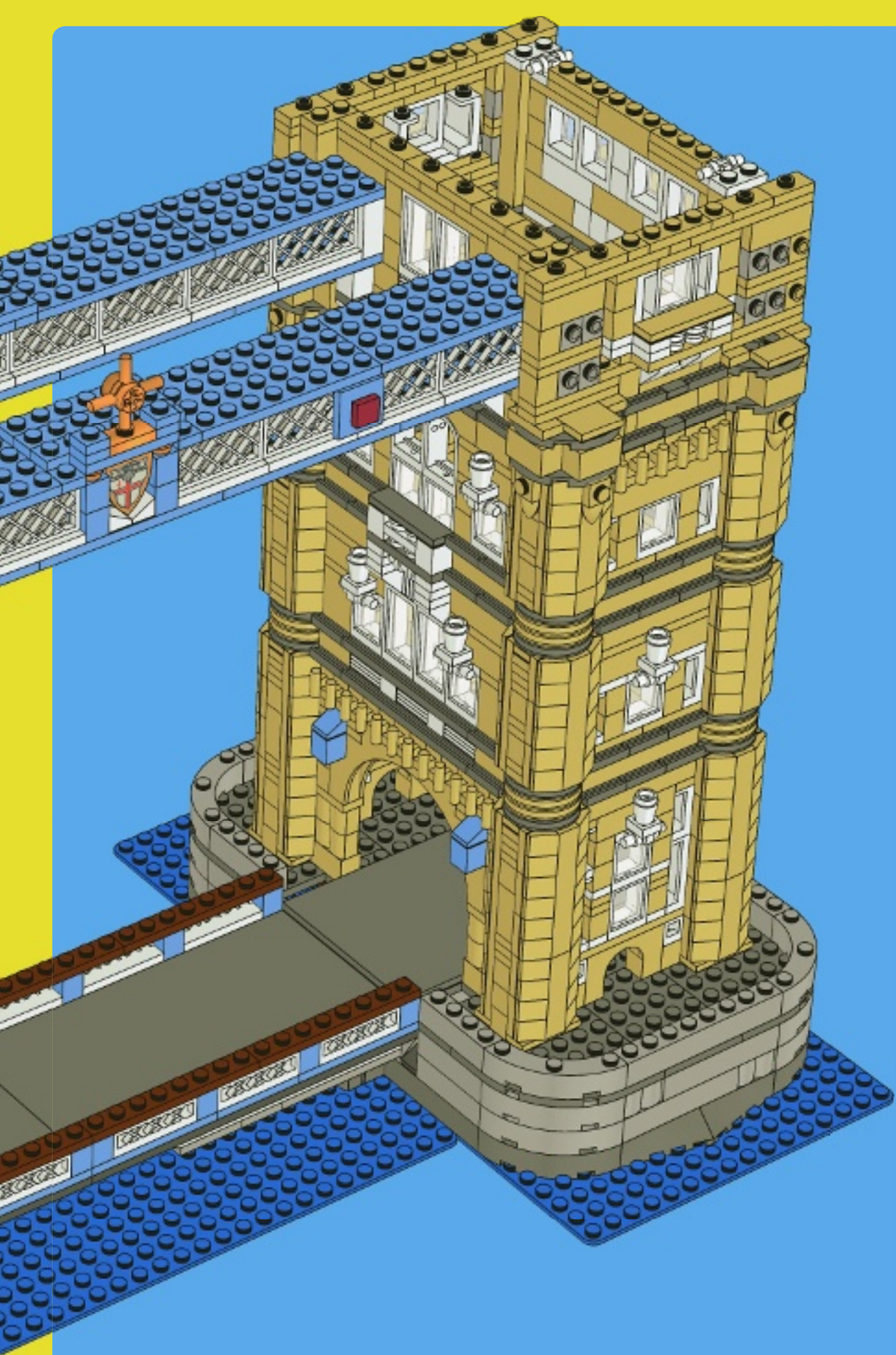

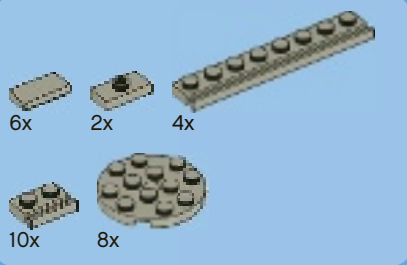

15

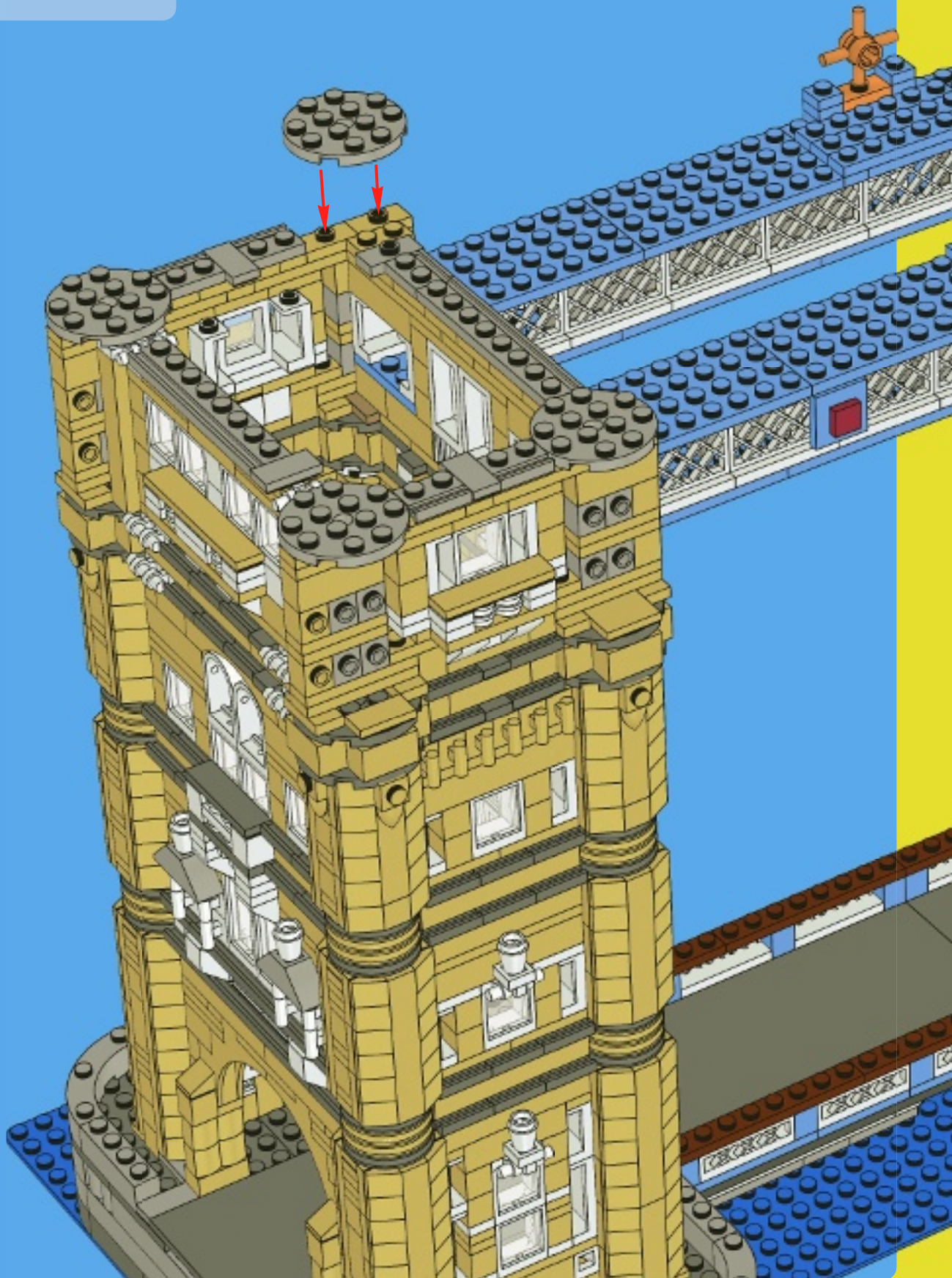

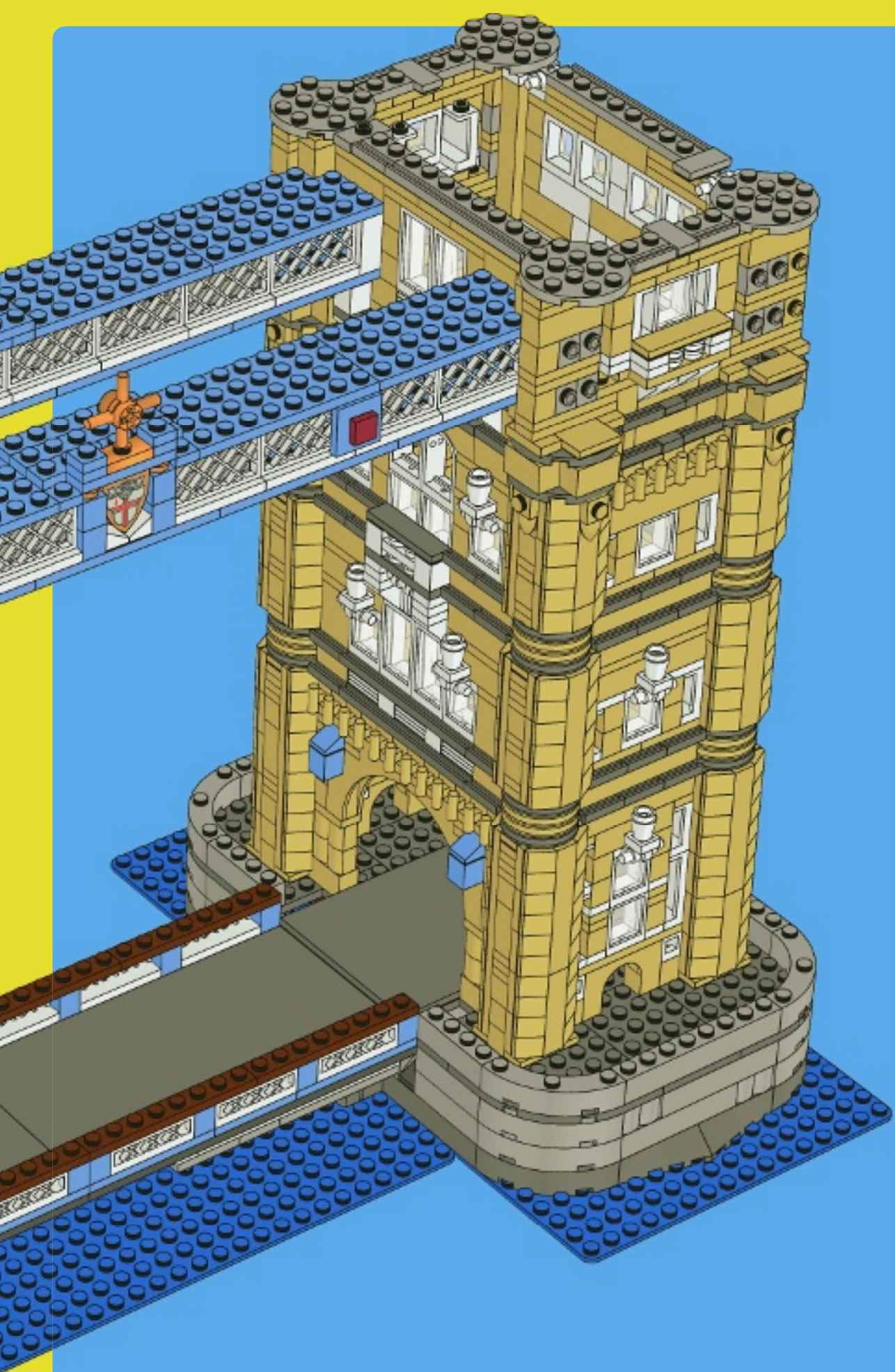



4x



24x

16

1

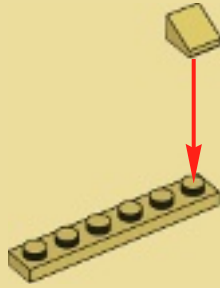

2

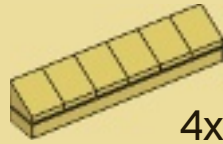

4x

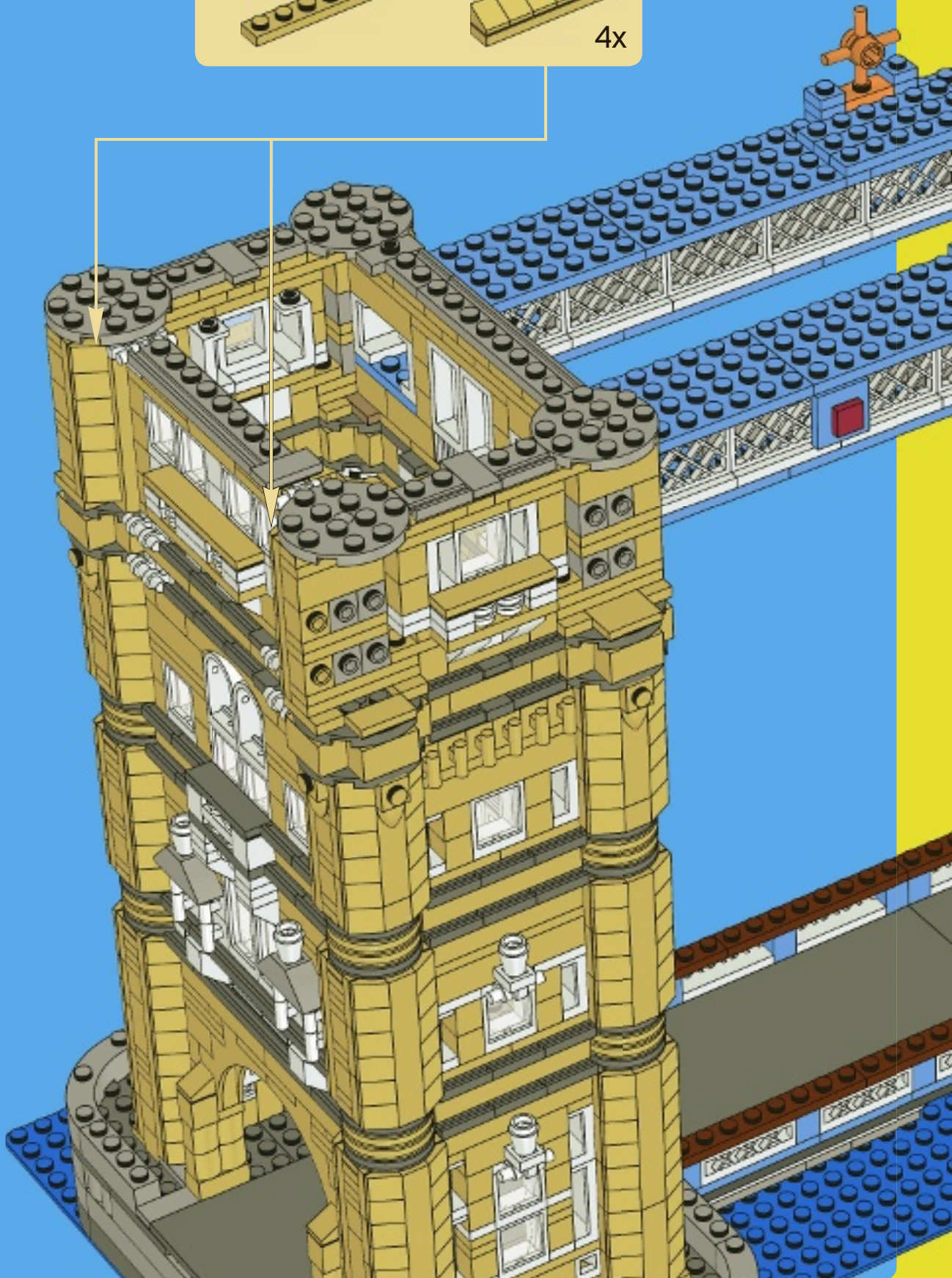

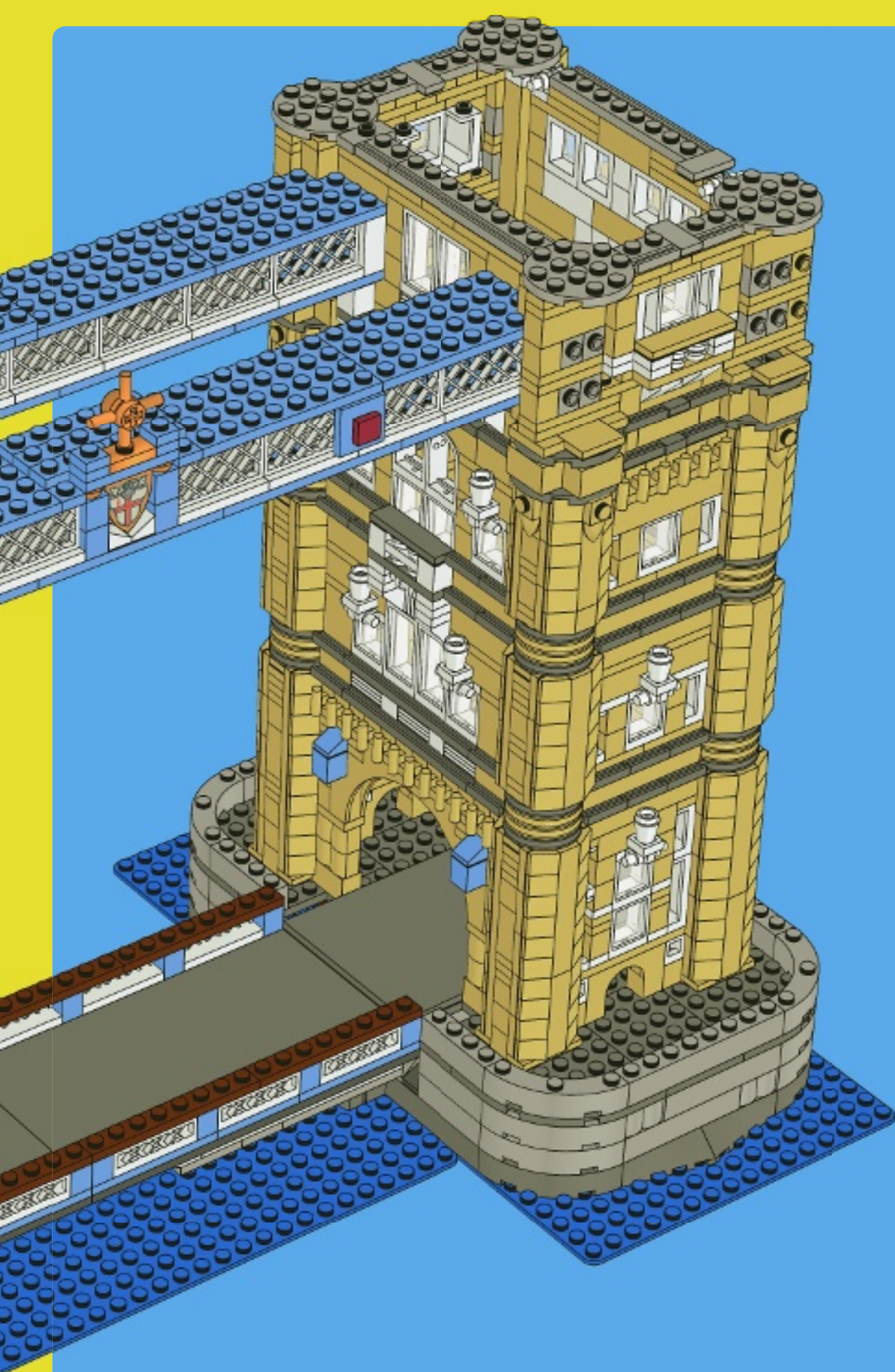

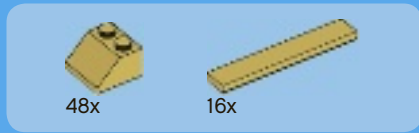



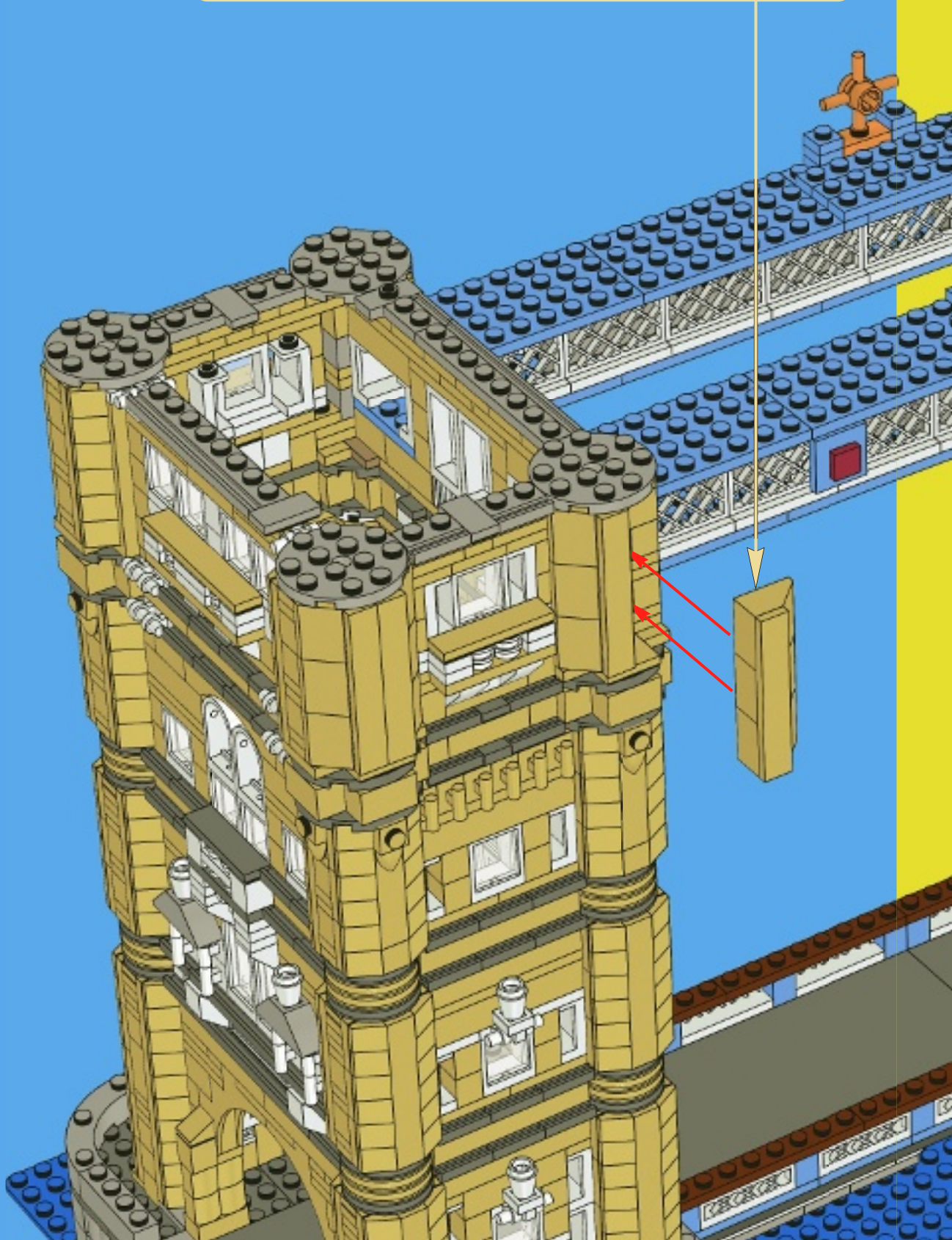
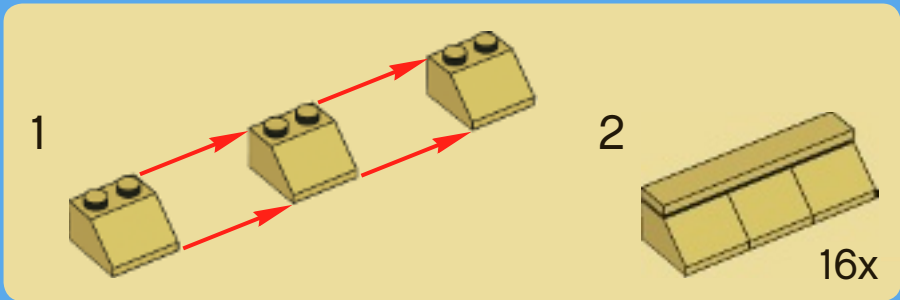

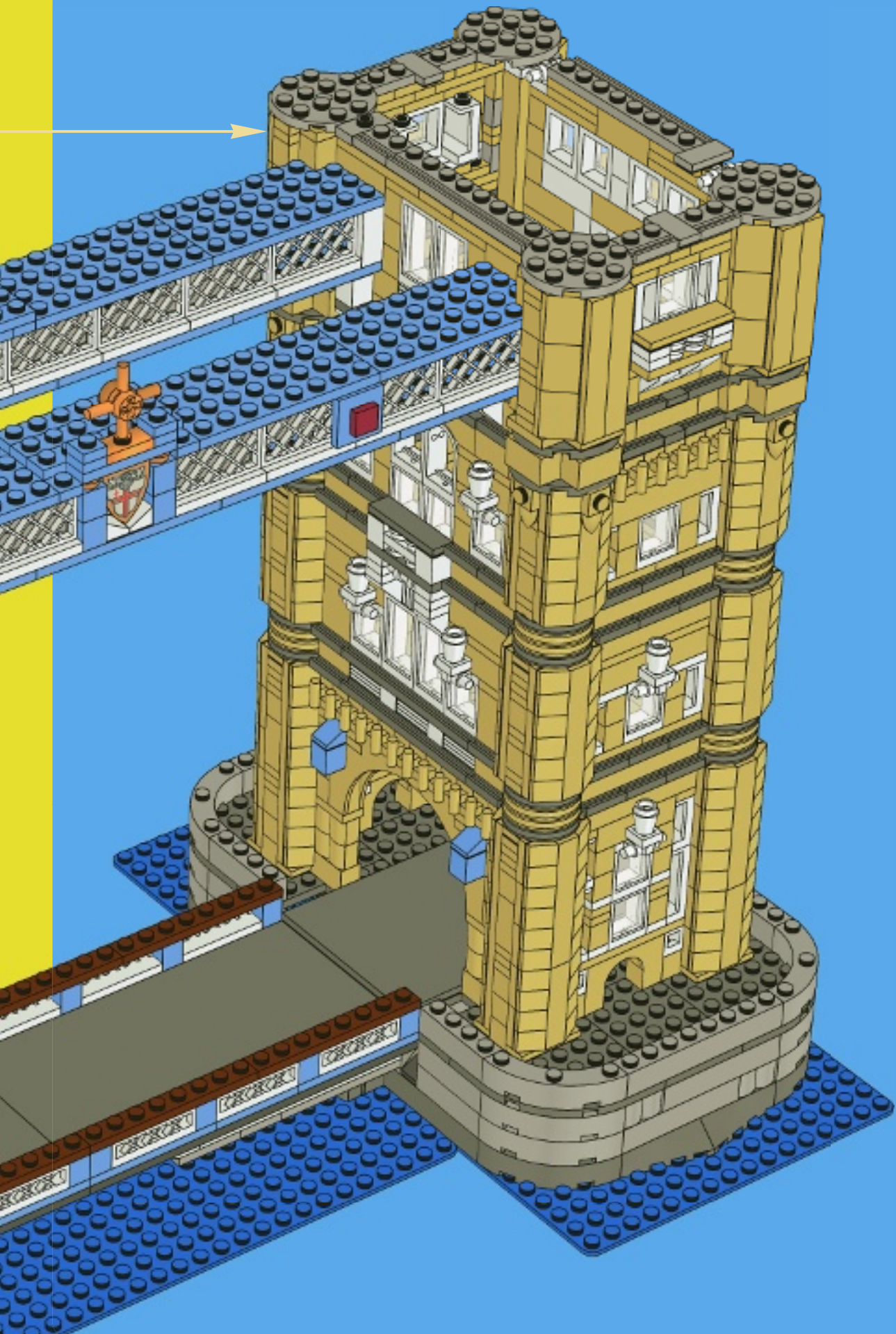

17





- 2x 
- 8x 
- 2x 
- 4x 
- 4x 
- 14x 

18

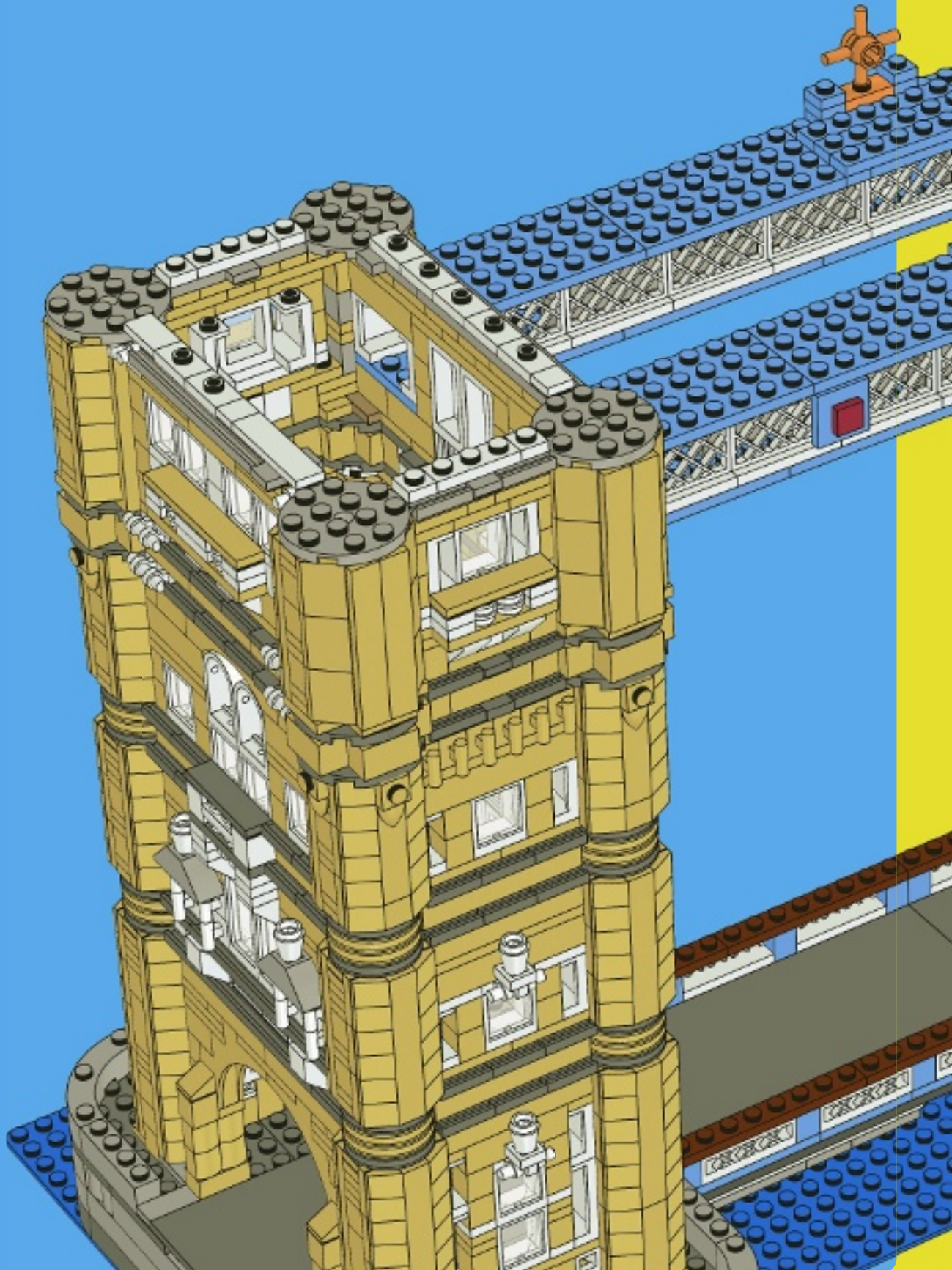

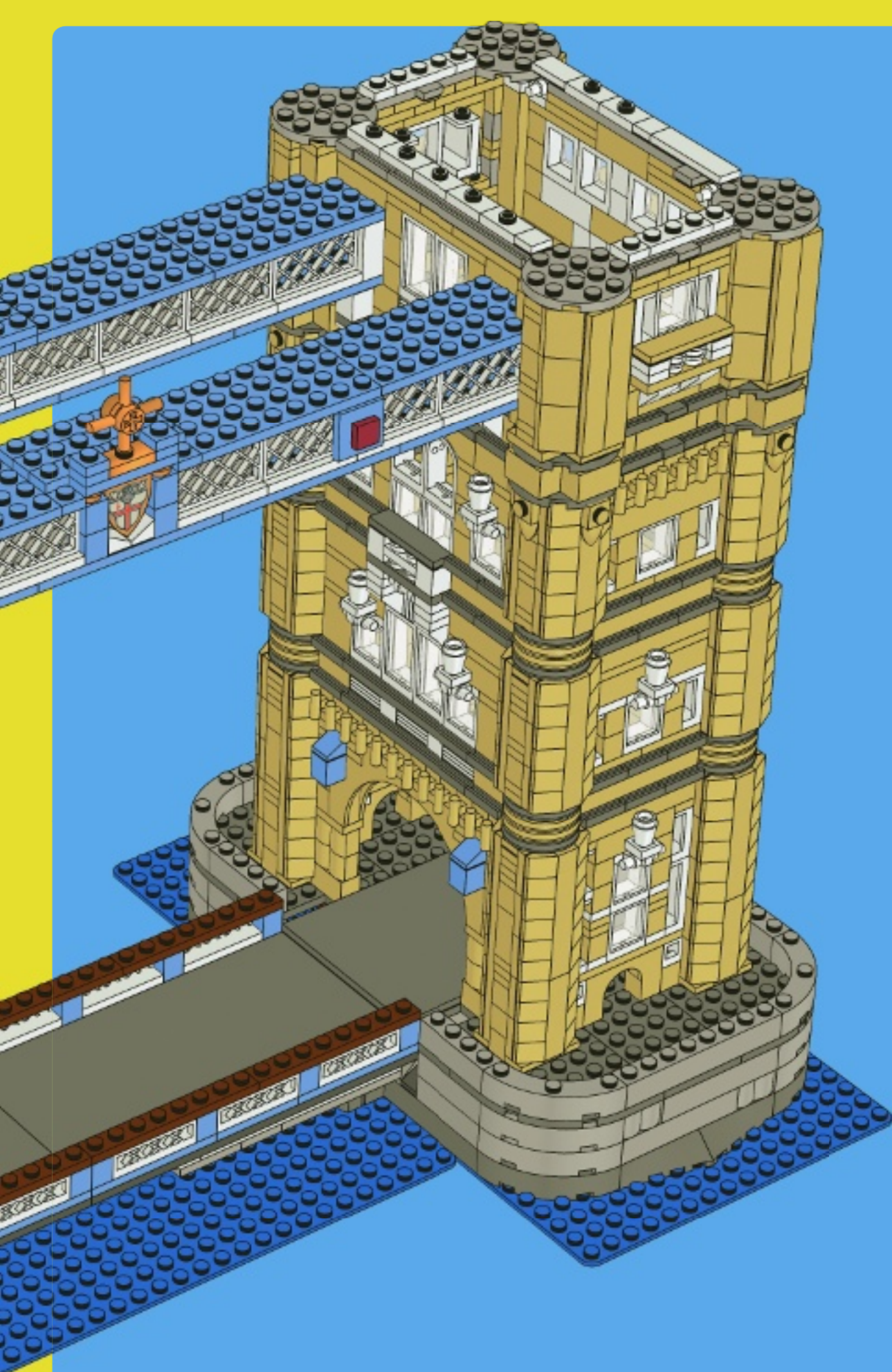



4x



24x



8x

19

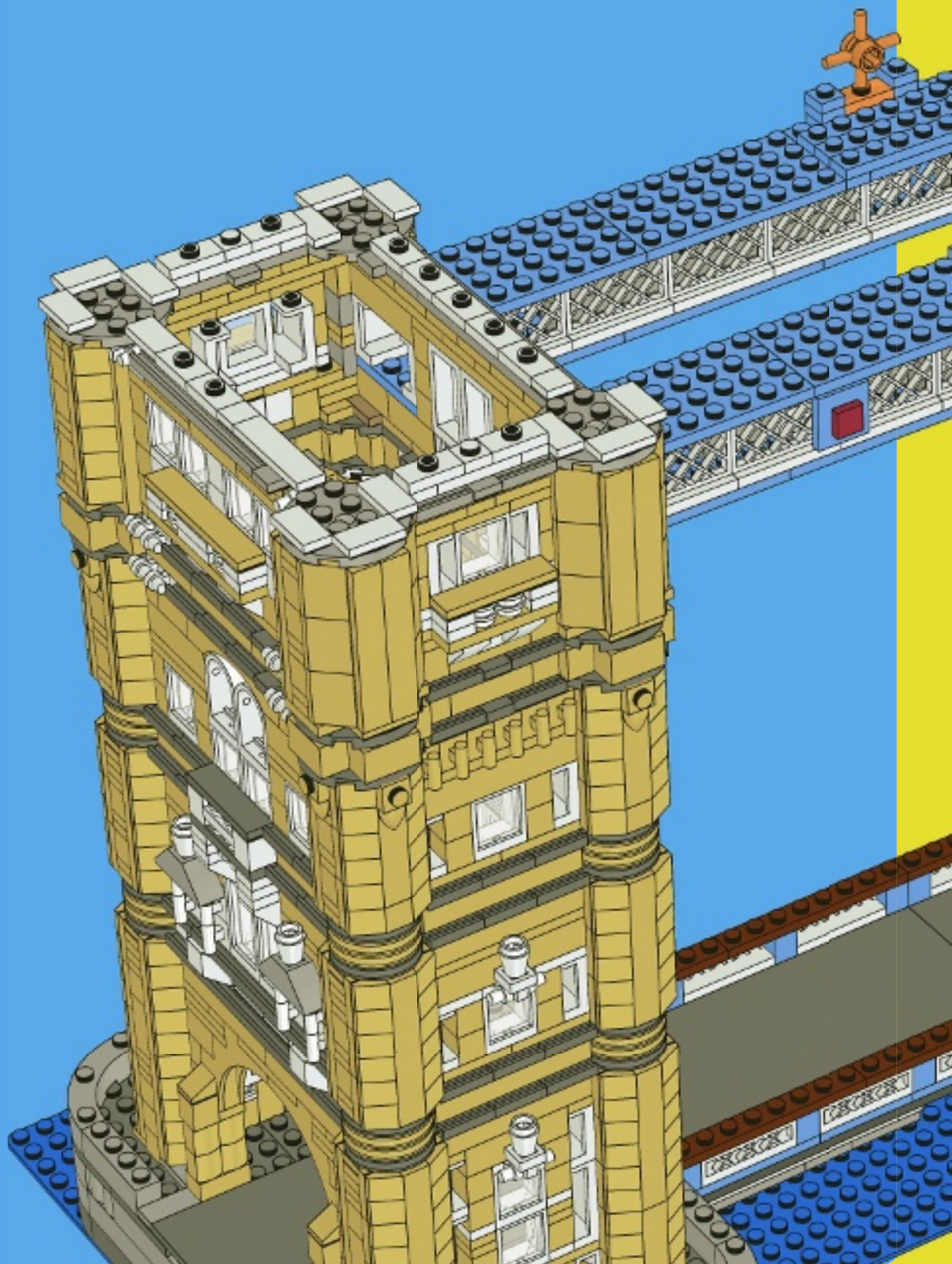

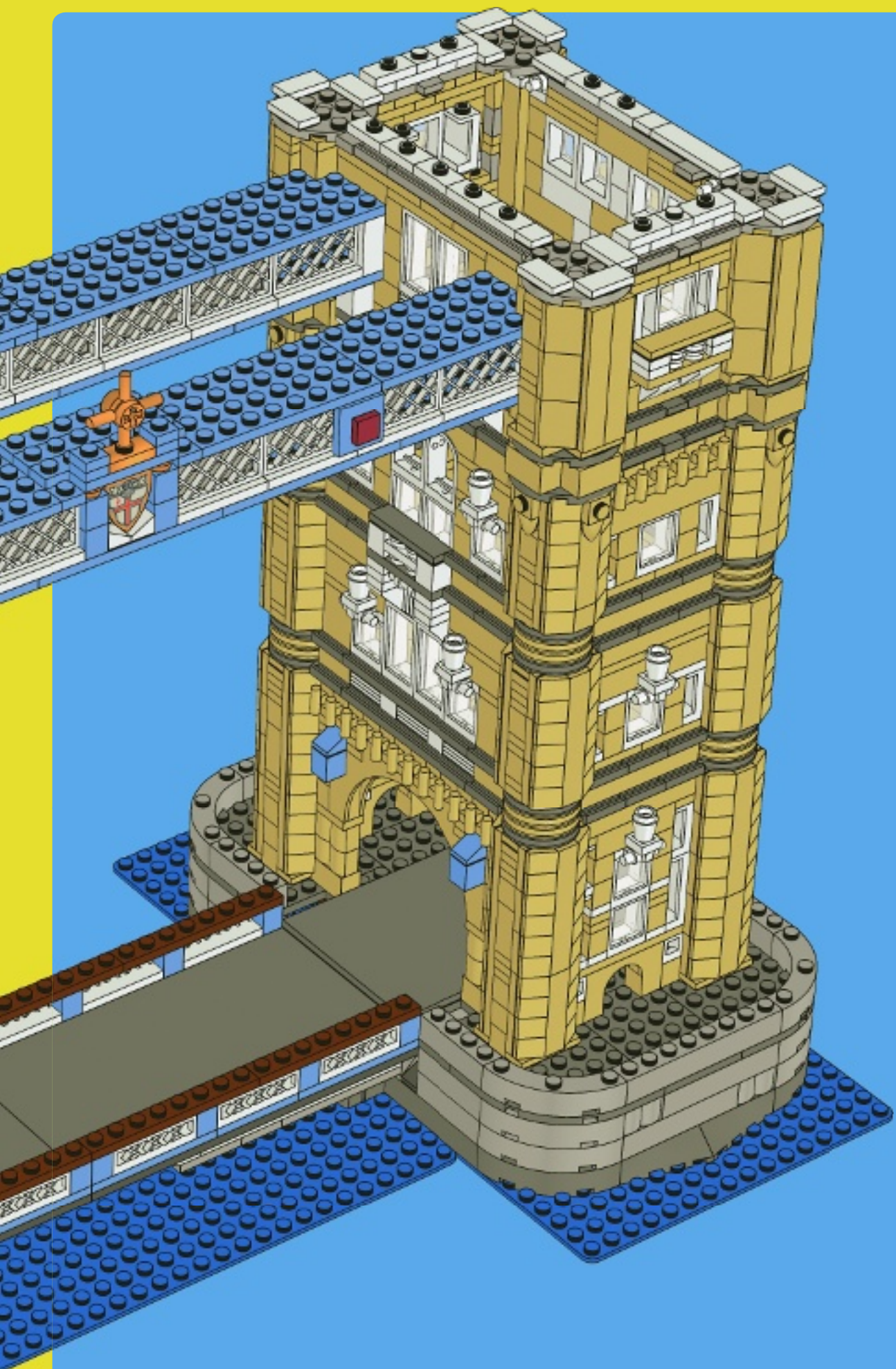



12x

20

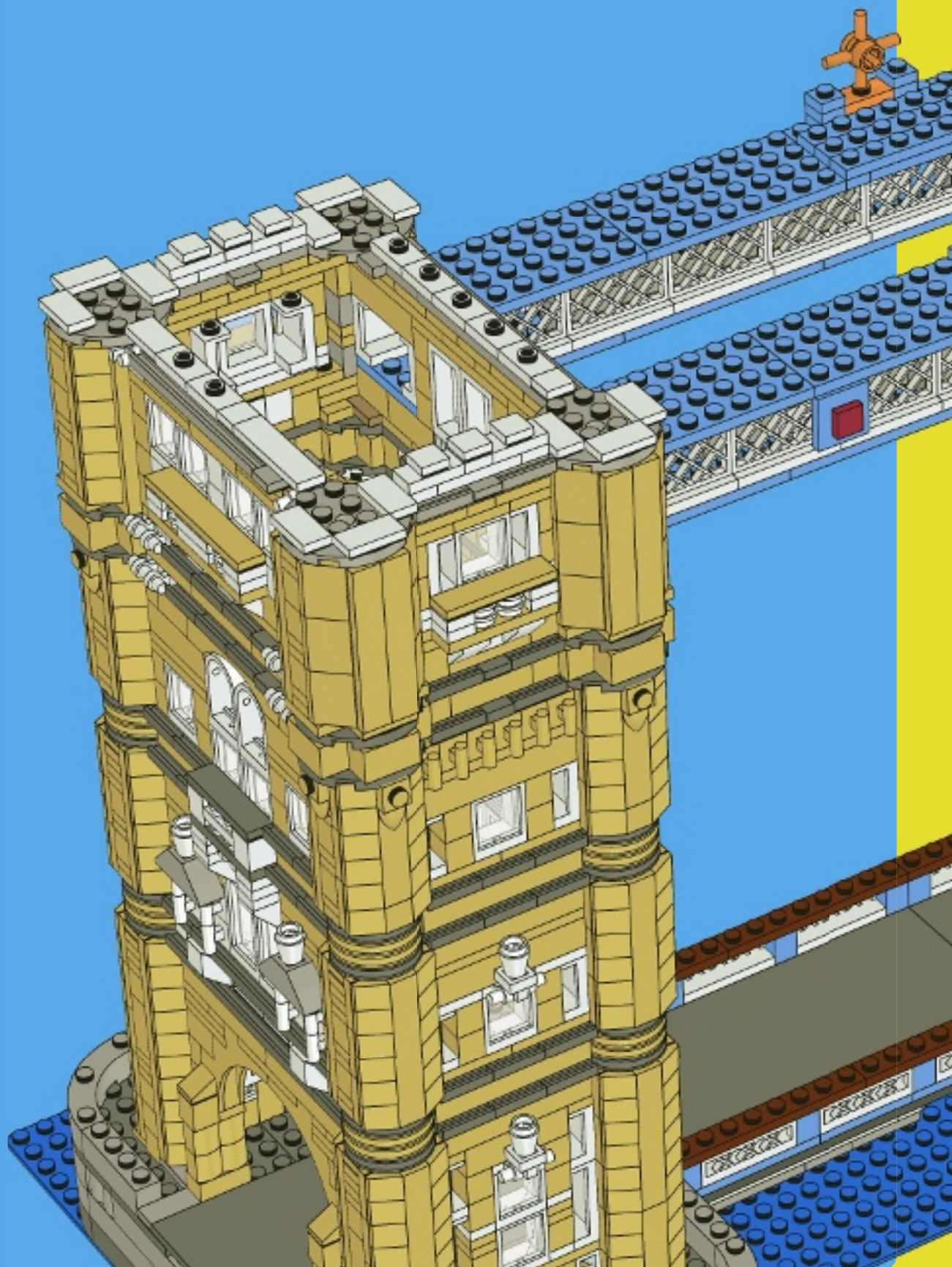

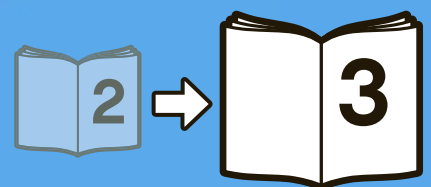
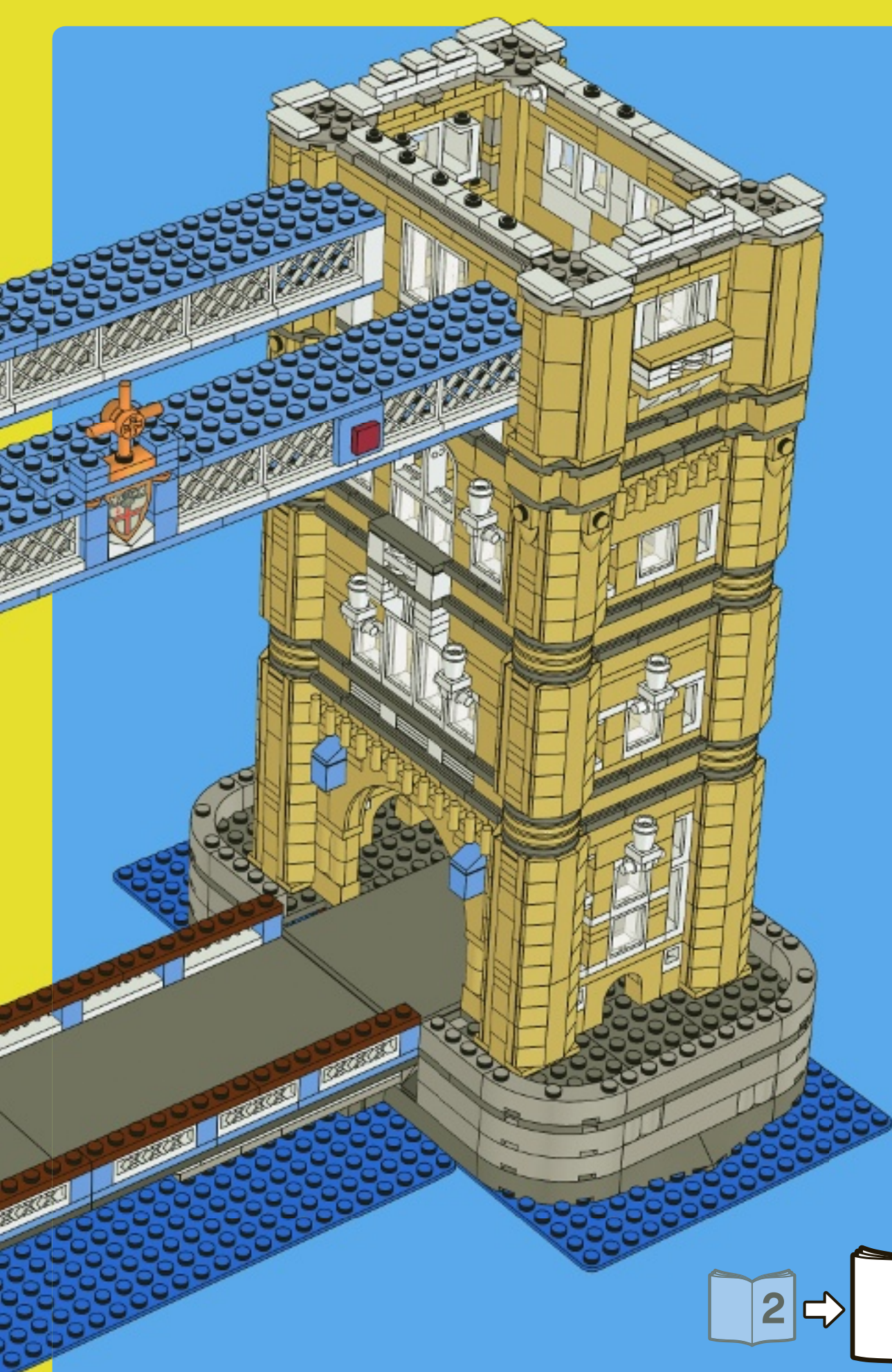



10189